



From the collection of the

o P<sup>z</sup>r<sup>n</sup>e<sup>m</sup>L<sup>a</sup>inger<sup>a</sup>  
v Library  
t p

San Francisco, California  
2007





Digitized by the Internet Archive  
in 2007 with funding from  
Microsoft Corporation

<http://www.archive.org/details/radiobroadcast08gardrich>

NOV.  
1925

35  
CENTS

# RADIO BROADCAST



CONSTRUCTORS'  
NUMBER

DESIGNS OF SEVERAL  
NEW RECEIVERS

Who Owns Our Radio Sets?  
How A Broadcasting Station Is Run

Doubleday, Page & Co.

Garden City, N. Y.



# Cunningham

## RADIO TUBES

Since 1915—Standard for All Sets



TYPES, C-301A · C-299 · C-300 · C-11 · C-12

IN THE ORANGE AND BLUE CARTON

Whenever perfection is approached in any manufactured product, the qualities of that product soon become known to the great American public. Thus it has been with Cunningham Radio Tubes. From Maine to California, from the Florida Keys to Puget Sound, they have made themselves known in millions of American homes. Throughout the nation these tubes are now associated with all that is best in radio. That you may come to know the delight, the charm, of radio, when every variation of tone is flawlessly recreated, install Cunningham Radio Tubes in every socket of your receiver. Then music becomes like the laughter of clear, swift-flowing water; and the human voice like something not quite human but divine.

**Price**  
**\$2.50**  
**Each**

*E. J. Cunningham Inc.*

Chicago

Home Office: 182 Second Street  
San Francisco

New York

★ Tested and approved by RADIO BROADCAST ★

490549

Bound  
Reprinted

MA 13 '26

# RADIO BROADCAST

VOLUME VIII

NOVEMBER, 1925, to APRIL, 1926



GARDEN CITY . . . NEW YORK

DOUBLEDAY, PAGE & COMPANY

1926

# INDEX

(\*Illustrated Articles. Editorials in Italics)

	PAGE		PAGE		PAGE
*A. C. Receiver and Power Amplifier, An (James Millen).....	57	*Five-Tube Receiver of Dual Efficiency, A (Glenn H. Browning).....	172	*Improving the Cone Speaker.....	50
<i>Additional Opinions About the Naval Radio Service</i> .....	552	<i>Fourth National Radio Conference, What Happened at the</i> .....	431	<i>Institute of Radio Engineers Convention, The</i> .....	653
*All-Purpose Coil Winder, An (Edward Thatcher).....	582	<b>G</b> RID, The:		<i>Interesting Things Said Interestingly</i> 27, 171, 304, 435, 557, 656	656
**"Aristocrat":		Aristocrat Values.....	376	International Tests:	
**"Aristocrat," The Radio Broadcast (Arthur H. Lynch).....	28	C Batteries in the Detector Circuit.....	484	*First Report on the International Tests, The (Willis K. Wing).....	588
**"Aristocrat" Receiver, The.....	664	Coil Placement in an R. F. Amplifier.....	226	*International Radio Broadcasting Tests, The 1926 (Willis K. Wing).....	462
**"Aristocrat" Receiver, The: Resistance-Coupled Amplification.....	196	Condensers in Series and Parallel.....	698	*Plans for the Third of the International Radio Broadcast Tests (Arthur H. Lynch).....	185
*As the Broadcaster Sees It (Carl Dreher).....	45, 191, 326, 467, 568, 672	Eliminating the Reflex in the Roberts Circuit.....	696	<i>Recent International Radio Broadcast Tests, The</i> .....	654
*Audio Amplification, Better (Kendall Clough).....	308	Explaining Static and Fading..	72	What Happened During the 1926 International Tests (Willis K. Wing).....	647
Australian Broadcasting Stations, A List of.....	224	Explanation of Tuning, An....	482	<i>Is the Loop or Antenna Receiver More Popular?</i> .....	433
<b>B</b> EST in Current Radio Periodicals, The (E. G. Shalkhauser).....	88	How to Charge Storage Batteries from D. C.....	596	<i>Is Your Set a Blooper?</i> .....	238
*Better Audio Amplification (Kendall Clough).....	308	How to Obtain Better Regeneration.....	482	<b>KEY</b> to Recent Radio Articles, A (E. G. Shalkhauser).....	88, 232, 380, 504, 608, 710
Blooper? Is Your Set a.....	238	Impedance Amplifiers.....	378	<b>L</b> ANGMUIR Patent, A Note on the... Late News on the International Tests (Willis K. Wing).....	555
Book Reviews:		Impedance Coupled Amplifier, An.....	700	<i>Legal Test Case for our Radio Laws, A..</i>	652
"Economics of the Radio Industry".....	514	Loop Construction.....	84	*Light Keepers, Radio Sets for.....	666
"Radio: Beam and Broadcast".....	388	Making Your Own Grid Leaks	596	List of Australian Broadcasting Stations, A.....	224
Booklet of Foreign Broadcasting Stations, "Radio Broadcast's" (Lawrence W. Corbett).....	465	Measuring the Resistance of Coil Units.....	228	*Listeners' Point of View, The (Kingsley Welles).....	32, 177
<i>Broadcast Listeners Organize</i> .....	555	New Tubes and Their Characteristics.....	596	*Listeners' Point of View, The (John Wallace).....	317, 445, 577, 667
*Broadcast Receiver, A Model 1926 (Mc Murdo Silver).....	36	Noises and Their Causes.....	376	*MAN and His Hobby, A (E. E. Horine).....	547
<i>Broadcast Relaying, The Progress of</i> ....	24	One Dial Loop Receiver.....	594	*March of Radio, The (J. H. Morecroft).....	23, 167, 300, 431, 552, 652
*CAN We Forecast Radio Reception from the Weather? (J. C. Jensen).....	558	Precautions in Antenna Erection.....	226	*Methods of Controlling Oscillation in Radio Frequency Circuits (John Bernard).....	350
<i>Canada As Our Instructor</i> .....	170	Protecting the Loud Speaker... Receiver Coil Resistance.....	484, 84	*Model 1926 Broadcast Receiver, A (Mc Murdo Silver).....	36
<i>Canada, How They Run Radio in</i> .....	655	Separate R. F. Tube Voltage from B Battery Eliminator... Substituting Toroid Coils in Neutrodyne.....	594, 86	<i>Month in Radio, The</i> 26, 170, 304, 434, 556, 656	656
*Cone Loud Speaker, Improving the... Conferences, A Year of.....	50, 26	Tubes and R. F. Coils: How They Should be Matched in a Receiver.....	228, 696	<i>More Information on Super Power</i> .....	169
*Controlling Oscillation in Radio Frequency Circuits, Methods of (John Bernard).....	350	"Universal" Receiver Coils.....	696	<i>More Millions for Radio</i> .....	555
<i>Convention, The Institute of Radio Engineers</i> .....	653	*Grimes Inverse Duplex, How to Build a (Florian J. Fox).....	439	*Multiple Regeneration Can Do For Your Tuned R. F. Amplifier, What (V. D. Landon).....	563
Current Radio Periodicals, The Best in (E. G. Shalkhauser).....	88	<b>H</b> IGH-SPEED Fading.....	392	<b>N</b> ATIONAL Association of Broadcasters.....	168
*Current Supply Unit, An Improved (Roland F. Beers).....	186	History of the Vacuum Tube, The Fascinating.....	300	<i>National Radio Council? Shall We Have A..</i> .....	23
*Cutting Out the Locals (H. E. Rhodes).....	686	*Home Laboratory, Standards for the (Keith Henney).....	573	<i>Naval Radio Service, Additional Opinions About the</i> .....	552
*DESIGN of Radio Inductances (W. W. Harper).....	436	*How a Portable B Battery Transmitter Works (Laboratory Staff).....	678	<i>Naval Radio Service? What is the Matter With the</i> .....	167
<i>Detroit Has a Good Radio Supervisor</i> ....	433	**"How Long Will My B Batteries Last?" (George C. Furness).....	452	*New Fields for the Home Constructor (Keith Henney).....	201
<b>E</b> CONOMICS of the Radio Industry" (Book Review).....	514	*How Radio Grew Up (Robert H. Marriott).....	159, 643	*New in Radio? What's (Austin C. Lescarboura).....	305
*Ether Waves You Cannot Hear (James Stokley).....	295	<i>How Radio Has Improved</i> .....	303	<i>New Short Wave Ray Is Discovered, A..</i>	433
<i>Ethics of Radio Advertising, The</i> .....	434	<i>How They Run Radio in Canada</i> .....	655	*New Way to Make Money in Radio, A (D. C. Wilkerson).....	606
<b>F</b> ACTS About the Farmer and Radio, The.....	170	*How to Build a Grimes Inverse Duplex (Florian J. Fox).....	439	News on the International Tests, Late (Willis K. Wing).....	299
*Filament Resistance, The Use of the (John Brennan).....	682	*How to Eliminate Local Interference I02.....	212	<i>Note on the Langmuir Patent, A</i> .....	555
*First Report on the International Tests, The (Willis K. Wing).....	588	*How to Use Meters in Your Receiver (James Millen).....	198		
\$500 Short Wave Receiver Contest, The	657	*How to Use Vacuum Tubes (Keith Henney).....	456		
*Five-Tube Receiver for the Inexperienced Constructor, An Improved (A. H. Fulton, Jr.).....	51	<b>I</b> F YOU Seek Economy, Buy the Best (Harold Jolliffe).....	360		



INDEX—Continued

PAGE	PAGE	PAGE			
*Notes on the Model 1926 Receiver (Ernest R. Pfaff).....	313	*Portable B Battery Transmitter Works, How a (Laboratory Staff)....	678	<i>What the "Straight Line Frequency" Condenser Means</i> .....	23
***"Now, I Have Found":		<i>Praiseworthy Bit of Radio Research, A..</i>	431	*When the Doctor Came to the Faralones—by Radio (Lewis N. Waite)...	63
Better Reproduction in Cone Speakers (William C. Morrill)	702	Prize Contest Announcement.....	444	<i>Who Invented the New Photo-Electric Cell?</i> .....	555
Checking Up On B Battery Leakage (Claude Schuder)...	210	<i>Progress of Broadcast Relaying, The</i> ....	24	*Winner of Our \$500 Prize Cover Contest, The.....	100
Coil Design Data (Boris S. Naimark).....	488	<i>Progress of Radio in 1925, The</i> .....	553		
Coupling Device for the Roberts Circuit, A (Clarence J. Frenck).....	208	<i>Pure Science Becomes Practical</i> .....	302		
Cylindrical Coils for the Knock-out Set (L. O. Doran).....	374				
Description of a New NP Coil for the Roberts Receiver (Ralph D. Tygert).....	66	<b>R</b> ADIO Broadcast "Aristocrat," The (Arthur H. Lynch).....	28		
Economical Sub-Panel Brackets (R. L. Douglas).....	706	Radio Broadcast's Booklet of Call Signals (Lawrence W. Corbett).....	337		
Efficient Coil Covering the Broadcasting Frequencies (W. H. Mayfield).....	70	Radio Broadcast's Booklet of Foreign Broadcasting Stations (Lawrence W. Corbett).....	465		
File for Ideas, A (F. E. Kunkel)	208	Radio Broadcast's Universal Receiver (Arthur H. Lynch).....	332		
Good Audio Amplifier, A (Edward T. Werden).....	490	Radio Broadcast's Universal Receiver..	450		
Good Audio By-Pass Method, A (Jerome Kidder).....	600	<i>Radio Business As Others See It, The</i> ..	25		
Good Neutralizing Condenser for the Roberts Circuit, A (H. A. Franchere).....	68	***"Radio Central"—Conqueror of Time and Distance (Fred. J. Turner).....	41		
Handy Battery Throw-Over Switch (Bernard Salzberg)....	706	<i>Radio Control for Railroads</i> .....	432		
Home-Made Coil Winder for Diamondweave Coils (R. S. Hart).....	704	<i>Radio for 1926: A Forecast</i> .....	24		
Home-Made Loud Speaker, A (J. T. Garver).....	364	*Radio Grew Up, How (Robert H. Marriott).....	643		
How to Make Balloon Coils (John L. Lee).....	600	*Radio Sets for Light Keepers.....	666		
How to Obtain Improved Loud Speaker Reproduction (Boris S. Naimark).....	602	*Radio: The Jungleman's Newspaper (John W. Swanson).....	427		
How to Provide a Counterpoise System (J. B. Greenman)....	702	Recent International Radio Broadcast Tests, The.....	654		
Improving the Volume of the Two-Tube Roberts Circuit (J. W. Teale).....	492				
Lead-In Problem, A (G. A. Luers).....	70	<b>S</b> HALL We Have a National Radio Council?.....	23		
Low Loss Coil, A (Everett Freeland).....	602	<i>Short Wave Ray Is Discovered, A New..</i>	433		
Measuring High Resistance (Claude Schuder).....	66	Short Wave Receiver Contest, The \$500	640		
One Use for a Bypass Condenser (K. B. Humphrey).....	604	Short Wave Stations of the World.....	708		
Ratchet Coil Winder Prevents Unwinding, A (G. A. Luers).....	206	*Short Wave Transmitter, A Universal (Nicholas Hagemann).....	321		
Roberts Circuit and Audio Amplifier Without a Storage Battery, The (J. B. Clothier, Jr.).....	362	*Short Waves—A New Paradise for the DX Fan (Edgar H. Felix).....	182		
Short Waves on the Hanscom Super-Heterodyne (A. T. Hanscom).....	68	<i>Short Waves Are Growing Shorter</i> .....	303		
Simple Long-Wave Receiver, A (H. H. Buckwalter).....	490	Standards for the Home Laboratory (Keith Henney).....	573		
Some Notes on Silver's Model 1926 Receiver with Choke Amplification (Davenport Hooker).....	702	"Straight Line Frequency" Condenser Means, What the.....	23		
Storage Battery, The (J. B. Clothier, Jr.).....	362	*Super-Heterodyne Construction (Harold C. Weber).....	589		
Tracing Radio Noises (A. H. Klingbeil).....	206				
Using a Voltmeter As a Milliammeter (Claude Schuder).....	488	* <b>T</b> HEY Shut the Door on Fortune (C. S. Thompson).....	19		
Variometer to Tune Antenna Circuit of the Roberts Set, A (John L. Lee).....	210	*Tube and Its Best Uses, The (Keith Henney).....	658		
Winding Spider Web Coils (H. Edward Knies).....	492				
OFFICIAL Indiscretion, An".....	653	* <b>U</b> NIVERSAL RECEIVER, Radio Broadcast's (Arthur H. Lynch).....	332		
<b>P</b> HOTO-ELECTRIC Cell? Who Invented the.....	555	*Universal Receiver, Radio Broadcast's	450		
*Plans for the Third of the International Radio Broadcast Tests (Arthur H. Lynch).....	185	*Universal Short-Wave Transmitter, A (Nicholas Hagemann).....	321		
		*Use of the Filament Resistance, The (John B. Brennan).....	682		
		<b>V</b> ACUUM Tube, The Fascinating History of the.....	300		
		*Vacuum Tubes, How to Use (Keith Henney).....	456		
		<b>W</b> AVELENGTH-FREQUENCY Chart.....	472		
		*Wavelength-Frequency Conversion (Homer S. Davis).....	471		
		What Constitutes a Radio Patent? (Leo T. Parker).....	494		
		*What Do We Know About Short Waves? (Keith Henney).....	54		
		<i>What Happened at the Fourth National Radio Conference</i> .....	431		
		*What Happened During the 1926 International Tests (Willis K. Wing)....	647		
		*What's New In Radio (Austin C. Lescarboursa).....	305		
		<i>What Is the Matter With the Naval Radio Service?</i> .....	167		
		*What Multiple Regeneration Can Do for Your Tuned R. F. Amplifier (V. D. Landon).....	563		
		What Our Readers Write Us.....	110, 244, 394, 518, 618, 716		
		<i>What the Australians Think of Their Broadcasting</i> .....	653		

PORTRAITS

(\*Portraits in "The March of Radio")

*Arlin, H. W.....	24
Arnoldi, Florence Long.....	33
Branly, Edouard.....	643
Brees, Anton.....	445
Cadman, S. Parkes.....	319
Damrosch, Walter.....	667
De Forest, Lee.....	21
Diefendorf, William.....	669
*Dill, C. C.....	171
*Dubilier, William.....	304
Eckersley, E. P.....	434
Elliott, Frank W.....	177
*Fessenden, Reginald A.....	656
Golden, Ernie.....	34
*Hammond, John Hayes, Jr.....	303
Hansen, Cecilia.....	667
*Hayes, Cardinal.....	171
*Hazeltine, L. A.....	27
*Hogan, John V. L.....	27
Homer, Louise.....	178
*Housekeeper, William G.....	25
Kemp, C. S.....	645
Kent, A. Atwater.....	178, 556
*Kordi, I. H.....	303
*Langmuir, Irving.....	304
Lopez, Vincent.....	34
Ludlow, Godfrey.....	34
McLeod, Keith.....	34
MacNamee, Graham.....	319
Marconi, Guglielmo.....	644
Marriott, Robert H.....	159
Maude, Cyril.....	578
Mazarin, Mariette.....	32
Miura, Tamaki.....	579
Ryan, Quin A.....	319
*Saltzman, Charles Mc K.....	557
Sargent, Jean.....	33
Seidel, Toscha.....	178
*Shaw, Charles Gray.....	435
Smith, Fred.....	669
Stock, Frederick.....	579
Tesla, Nikola.....	644
Walsh, Edmund A.....	447
Werrenrath, Reinald.....	178
*West, A. G. D.....	656
Wiley, Louis.....	181
Zendonini, Elizabeth.....	22
*Zworykin, V. K.....	302

AUTHORS

Beers, Roland F.....	186
Bernard, John.....	350
Brennan, John B.....	682
Browning, Glenn H.....	172
Buckwalter, H. H.....	490
Clothier, John B. Jr.....	362

INDEX—Continued

	PAGE		PAGE		PAGE
Clough, Kendall	308	Hooker, Davenport	702	Parker, Leo T.	494
Corbett, Lawrence W.	337, 465	Humphrey, K. B.	604	Pfaff, Ernest R.	313
Davis, Homer S.	471	Jensen, J. C.	558	Rhodes, H. E.	686
Doran, L. O.	374	Jolliffe, Harold	360	Salzberg, Bernard	706
Douglas, R. L.	706	Kidder, Jerome	600	Schuder, Claude	66, 210, 488
Dreher, Carl	45, 191, 321, 467, 568, 672	Klingbeil, A. H.	206	Shalkhauser, E. G.	88, 232, 380, 504, 608, 710
Felix, Edgar H.	182	Knies, H. Edward	492	Silver, McMurdo	36
Fox, Florian J.	439	Kunkel, F. E.	208	Stokley, James	295
Franchere, H. A.	68	Landon, V. D.	563	Suggs, I. T.	210
Freeland, Everett	602	Lee, John L.	210, 600	Swanson, John W.	427
Frenck, Clarence J.	208	Lescarbours, Austin C.	305	Teale, J. W.	492
Fulton, A. H., Jr.	51	Luers, G. A.	70, 206	Thatcher, Edward	582
Furness, George C.	452	Lynch, Arthur H.	28, 185, 332	Thompson, C. S.	19
Garver, J. T.	364	Marriott, Robert H.	159, 643	Turner, Fred J.	41
Greenman, J. B.	702	Mayfield, W. H.	70	Tygert, Ralph D.	66
Hagemann, Nicholas	321	Millen, James	57, 198	Waite, Lewis N.	63
Hanscom, A. T.	68	Morecroft, J. H.	23, 167, 300, 388, 431, 552, 652	Wallace, John	317, 445, 577, 667
Harper, W. W.	436	Morrill, William C.	702	Weber, Harold C.	589
Hart, R. S.	704	Naimark, Boris S.	488, 602	Welles, Kingsley	32, 177
Henney, Keith	54, 163, 201, 456, 573, 658			Werden, Edward T.	490
				Wilkerson, D. C.	606
				Wing, Willis K.	299, 462, 588, 647



# When the Loos Brothers Sing from W.E.B.H.

Robert Loos sits at home and hears them as naturally as though they were singing in the same room.

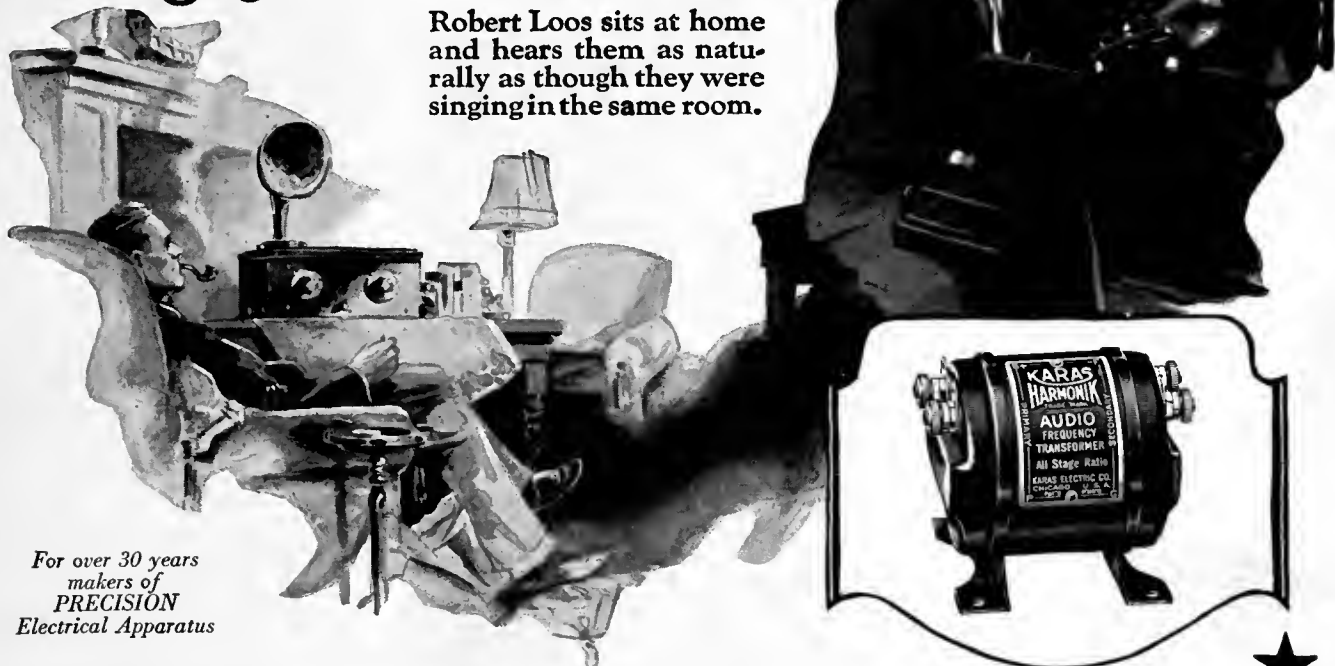

For over 30 years makers of **PRECISION** Electrical Apparatus

## Karas Harmonik Transformers ★ Amplify Radiocast Music with Absolute Fidelity!

No sooner had Karas Harmonik Transformers been introduced than letters began to pour in from all over the country.

Exacting set builders, after many disappointments, found in the Karas Harmonik an audio transformer which *really* amplified with tremendous volume — and positively without distortion.

"Now I know radio as I never knew it before." So Mr. E. M. Lubeck of Kokomo, Indiana, expressed himself. "Karas Harmoniks bring in every voice and every instrument as distinctly as one could get them in the room," wrote the Rev. Wm. Stellhorn of Columbus, Ohio. "I consider your transformer a real musical instrument. Like a good violin, it has fine tonal qualities at all pitches covering the musical scale," was the comment of Mr. Walter Krause of 7807 Burnham Ave., Chicago. Mr. G. C. Tubbs of Gratham, New York, told of his wonderful reception of a band concert from St. Louis, pointing out that every tone of every instrument could be picked out with perfect distinctness.

These few reports—picked at random from scores of letters—tell you more convincingly than we can tell you, the wonderful results YOU can obtain through installing Karas Harmonik Transformers in your new set if you build one—or your old set if you keep it. Nothing like it has ever been known before the Karas Harmonik was produced. Nothing approaching it has ever been developed since. Remember, the finest loud speaker can't overcome the shortcomings of defective or inefficient transformers.

Here, for your enjoyment, is an audio transformer, scientifically designed to reproduce through your speaker *all* of the beauty of Radiocast music—exactly as it is rendered

Karas Electric Co., Chicago, Ill.  
 Dear Sirs: I take great pleasure in praising your wonderful Karas Harmonic Transformers. I recommend them to the most critical. I am using two of them in a three-tube Low-Loss set which I built. I have two brothers singing from Edgewater Beach, WEBH Station, and whenever they are on we listen in. Well, their singing comes in so natural and clear that at times we think they are right in the same room with us. My brothers are known as Chicago favorites, the Loos Brothers, and they also tell me mine is the clearest set they have ever heard.  
 Respectfully yours,  
 Robert Loos, 1640 N. Leavitt St., Chicago, Illinois

in the studio, whether by a soloist or the largest band or orchestra.

The problem of amplifying high, low and medium audio frequencies to an equal degree has finally been solved. Sonorous bass notes pour forth from the speaker in full strength and rich tone quality. The vital harmonics and rich overtones are brought out in their true beauty by this marvel of audio transformers.

All last season, home set builders—the most discriminating class of radio enthusiasts—bought Karas Harmoniks and enjoyed a musical quality of radio reception that owners of factory-built sets knew nothing

about. For set manufacturers mistakenly thought they could not pay a little more for Karas Harmoniks than common kinds cost.

If you want the utmost pleasure that radio has to offer, get a pair of Karas Harmonik Transformers at once. Whether you are building a new set, or intend to remodel an old one, it is very easy to put in Karas Harmoniks. Or, if you don't care to install them yourself, any radio repair man will do it for you at small expense. Why not make up your mind right now to have the best music your set is capable of giving?

Most good radio dealers carry Karas Harmoniks. If your dealer is out of them, order direct on the coupon below. Send no money, just pay the postman.

**Karas Electric Co., 4043 N. Rockwell St., Chicago, Ill.**  
 Please send me \_\_\_\_\_ pairs of Karas Harmonik Audio Frequency Transformers. I will pay the postman \$7 apiece, plus postage, on delivery. It is understood that I am privileged to return the transformers any time within 30 days if they do not prove entirely satisfactory to me, and my money will be refunded at once.

Name \_\_\_\_\_  
 Address \_\_\_\_\_

If you send cash with order we'll send Transformers postpaid.

# RADIO BROADCAST

ARTHUR H. LYNCH, Editor  
WILLIS K. WING, Associate Editor  
JOHN B. BRENNAN, Technical Editor

NOVEMBER, 1925  
Vol. VII, No. 1

## CONTENTS

Cover Design	From a Painting by Fred J. Edgars	
England's Greatest Broadcasting Station	Frontispiece	
They Shut the Door on Fortune	C. S. Thompson	19
The March of Radio	J. H. Morecroft	23
The Radio Broadcast "Aristocrat"	Arthur H. Lynch	28
The Listeners' Point of View	Kingsley Welles	32
A Model 1926 Broadcast Receiver	McMurdo Silver	36
"Radio Central"—Conqueror of Time and Distance	Fred J. Turner	41
As the Broadcaster Sees It	Carl Dreher	45
Improving the Cone Loud Speaker		50
An Improved Five-Tube Receiver for the Inexperienced Constructor	A. H. Fulton, Jr.	51
What Do We Know About Short Waves?	Keith Henney	54
An A. C. Receiver and Power Amplifier	James Millen	57
When the Doctor Came to the Farallones—by Radio	Lewis N. Waite	63
"Now, I Have Found . . ."		66
<small>Measuring High Resistance—A New NP Coil for the Roberts Receiver—A Good Neutralizing Condenser—Short Waves on the Hanscom Super-Heterodyne—Solving a Lead-in Problem—An Efficient Coil</small>		
The Grid—Questions and Answers		72
<small>Some Facts About Static and Fading—Why Coils Work on One Frequency Better Than Another—How to Build a Loop—Substituting Toroid Coils in Neutrodyne</small>		
The Best in Current Radio Periodicals	E. D. Shalkauser	88
The Winner of Our \$500 Prize Cover Contest		100
How To Eliminate Local Interference		102
What Our Readers Write Us		110

## BEHIND THE EDITORIAL SCENES

WE ARE proud to present the new RADIO BROADCAST which in quality of appearance and contents speaks for itself, and we are confident that all our readers will feel the same as one enthusiastic subscriber who was in the office the other day and to whom we showed the plans of the new RADIO BROADCAST. "Why," said he, "there is nothing in the radio field to equal RADIO BROADCAST now that you have increased its size and succeeded in turning out a magazine of the splendid quality of this November number."

In this issue are described four complete receivers, any or all of them good enough to please the heart of the most discriminating of constructors. The RADIO BROADCAST "Aristocrat" is a single-control set with resistance coupling; Mr. Millen's receiver and power amplifier is the first one to be described employing important new developments with a.c. audio power amplifiers for the home constructor. The other articles are worthy of distinct attention each on its own merits.

MR. C. S. THOMPSON, the author of the interesting piece about Doctor DeForest, was for many years closely associated with him and knows whereof he speaks. Mr. Fred Turner, whose "Radio Central"—Conqueror of Time and Distance" appears in this number, is a broadcast speaker whose "Trips and Adventures" are familiar to WEAf and WJZ listeners. Readers who have been following the interesting discussion in Carl Dreher's department regarding the merits of so-called "super power" will read with great interest the concluding arguments in this word-battle. Those who have been curious about the internal human machinery of a great broadcasting station should read Mr. Dreher's leading article on page 45.

In the following numbers of the magazine, there will be articles of great interest to every one who follows radio. To make a confession, because of lack of space for many months, the editors have had to leave out almost as much material as appeared in the magazine. That embarrassment of riches means that the reader can be confident of some mighty good material in every number. One of the most interesting of the articles due to appear as soon as space can be made is by Roland F. Beers on "How to Build an Improved Plate Supply Unit" employing the new Raytheon tube, an improved "S" tube. The article is very complete constructionally and every part of the B supply unit is fully described. And Glenn H. Browning has developed an improved Browning-Drake receiver using impedance-coupled amplification which will be described soon.

Write and tell us how you like RADIO BROADCAST with its new cover and in its new form.

### Doubleday, Page & Co. MAGAZINES

COUNTRY LIFE  
WORLD'S WORK  
GARDEN & HOME BUILDER  
RADIO BROADCAST  
SHORT STORIES  
EDUCATIONAL REVIEW  
LE PETIT JOURNAL  
EL ECO  
THE FRONTIER

### Doubleday, Page & Co. BOOK SHOPS

NEW YORK, { LORD & TAYLOR BOOK SHOP  
PENNSYLVANIA TERMINAL (2 Shops)  
38 WALL ST.  
GRAND CENTRAL TERMINAL  
ST. LOUIS, { 223 NORTH 8TH STREET  
4914 MARYLAND AVENUE  
KANSAS CITY, { 920 GRAND AVENUE  
306 WEST 47TH STREET  
TOLEDO, LASALLE & KOCH  
CLEVELAND, HIGBEE CO.  
SPRINGFIELD, MASS., MEEKINS, PACKARD & WHEAT

### Doubleday, Page & Co. OFFICES

GARDEN CITY, N. Y.  
NEW YORK: 120 WEST 32ND STREET  
BOSTON: PARK SQUARE BUILDING  
CHICAGO: PEOPLES GAS BUILDING  
SANTA BARBARA, CAL.  
LONDON: WM. HEINEMANN LTD.  
TORONTO: OXFORD UNIVERSITY PRESS

### Doubleday, Page & Co. OFFICERS

F. N. DOUBLEDAY, *President*  
A. W. PAGE, *Vice-President*  
NELSON DOUBLEDAY, *Vice-President*  
RUSSELL DOUBLEDAY, *Secretary*  
S. A. EYERITT, *Treasurer*  
JOHN J. HESSIAN, *Asst. Treasurer*

DOUBLEDAY, PAGE & COMPANY, Garden City, New York

Copyright, 1925, in the United States, Newfoundland, Great Britain, Canada, and other countries by Doubleday, Page & Company. All rights reserved.  
TERMS: \$4.00 a year; single copies 35 cents.

# "Quality Is Season's Watchword"

"Fidelity of Tone Production Will Be Greatest Public Demand this Fall"—*Radio Retailing*, issue of August, 1925.

*Radio Retailing* asked one hundred dealers in ten states what was the most important thing in Radio today.

They all said "Tonal quality is the first requisite."

For years Daven has pioneered quality. It is gratifying to see our vision come true and our judgment substantiated.

Daven engineers have long recognized that the present day receiving set needed to be greatly improved from a quality standpoint. They worked

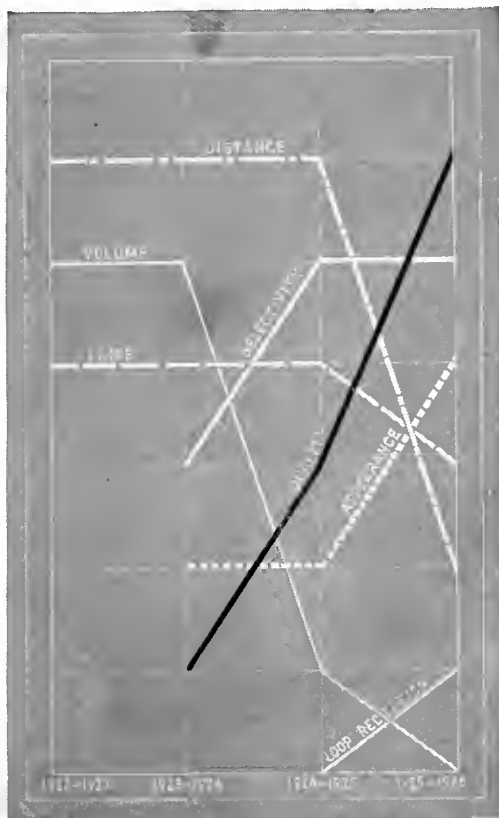

A graph from August issue of *Radio Retailing*, showing the most important selling point of Radio from 1922 to date.

and perfected Resistance Coupled Amplification, the only existing method known whereby you can procure amplification without distortion and no distortion means simply quality.

The Daven Resistance Coupled Amplifier shown below can be conveniently added to any existing set owned by the public. Manufacturers and amateur set builders should also investigate Daven Resistance Coupled Amplification. Your set will not be 1926 Model unless it is Daven Resistance Coupled.

## DAVEN RESISTANCE COUPLED AMPLIFICATION

**To the public**—Daven Resistance Coupled Super Amplifier in a genuine Bakelite base complete with all resistors, grid leaks and condensers inserted—\$15. In kit form, for those who like to build their own, including special Type A Daven Condensers, \$9.00.

**To radio dealers**—Send for our complete catalog and the name of our nearest established distributor.

**To set manufacturers**—The facilities of our Engineering Department are yours to command. Call upon

us at any time. We can offer you constructive advice on how to improve the audio end of your set.

THE RESISTOR MANUAL is the handbook of Resistance Coupled Amplification. At your dealer's 25c. By mail postpaid 30c. Dealers, write for a free copy.

*"The Sine of Merit"*

**DAVEN RADIO CORPORATION**

*Resistor Specialists*

Newark

Reg. U. S. Pat. Off.

New Jersey

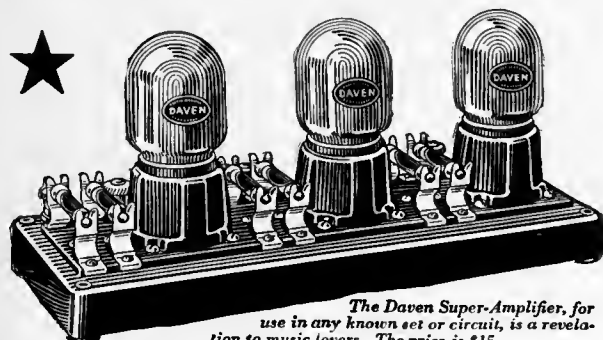

The Daven Super-Amplifier, for use in any known set or circuit, is a revelation to music lovers. The price is \$15.

DAVEN PRODUCTS ARE SOLD ONLY BY GOOD DEALERS

**CLIP THIS COUPON** E-11-25

DAVEN RADIO CORPORATION  
158-160 Summit Street, Newark, New Jersey

Please send me the following on Resistance Coupled Amplification:—

Check One  Resistor Manual. 30c. is enclosed.  
 Complete Catalogue (free).

Name. ....

Address .....

*For Dealers: Send your letterhead or card, or this coupon and we will have our nearest distributor communicate with you.*

# THE BIG LITTLE THINGS OF RADIO

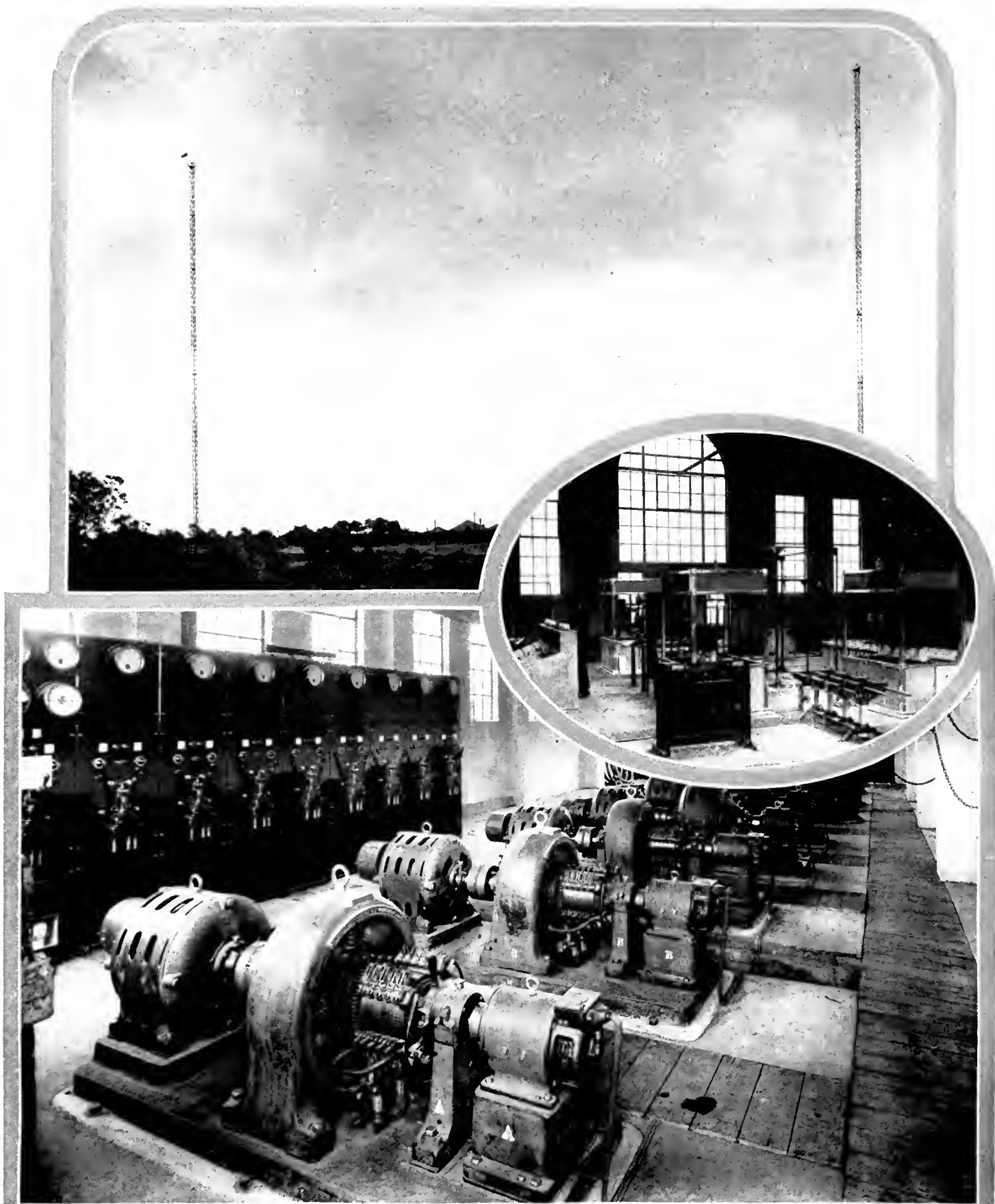

#### ENGLAND'S GREATEST BROADCASTING STATION

Three unusual views of the new high-power station of the British Broadcasting Company at Daventry. The top view (© Barratt's) shows the twin 500-foot masts with the station building in the center, silhouetted against the cloudy English sky. The illustration in the oval insert, which at first sight might be mistaken for the interior of the great hall in a castle, shows a corner of the transmitter house. The illustration below shows the eight generators necessary to supply the 25,000 watts for the transmitter. Programs are sent out on 187 kc. (1600 meters) and can be heard throughout a large part of England with only a crystal receiver

# RADIO BROADCAST

VOLUME VIII



NUMBER 1

NOVEMBER, 1925

## They Shut the Door on Fortune

**"Only a Toy," said the Wise Ones, of the Audion, and They Gave No Support to the "Aladdin's Lamp" of Radio—Some Important Incidents Hitherto Unpublished in the Life of Dr. Lee DeForest, Inventor of the Three-Element Vacuum Tube**

By C. S. THOMPSON

**O**N THE sands behind the coral reefs of Washington Island, in the Pacific South Seas, a thousand miles southwest of Honolulu, an audion bulb was picked up some years ago. Bits of water-soaked wood, a rusty spike, a length or so of frayed rope were not uncommon on the beach, but the audion bulb was something new in flotsam. Here the audion turned up on the shore of an island 900 miles west of the nearest steamer lane.

There was a radio telegraph station at Washington Island. R. A. Travers was the operator. He saw the audion bulb and recognized the handiwork of the inventor, and that night put the bulb in the mail, with the following letter:

Washington Island,  
Via Honolulu and Fanning Island.  
December 1, 1919.

"Dr. Lee DeForest,  
New York City,  
U. S. A.

DEAR DR. DEFOREST:

I am sending you by parcels post an interesting valve I believe to be one of your pre-war types. . . . This valve traveled many miles through the Pacific ocean, bobbed over a coral reef, and came to rest on the sands of this island. . . . Washington Island is a wee spot in the wide Pacific, having less than a dozen miles of coast. . . . From wreckage picked up from time to time, it appears drifting objects come from the eastward. . . . I believe this valve will be of interest in your collection.

R. A. TRAVERS."

Doctor DeForest, at his laboratory, did find the bulb to be one of his own pre-war types. The story of this "lost audion" set his imagination working.

"If I could spend a couple of months," he said, "away from all cares on a paradise

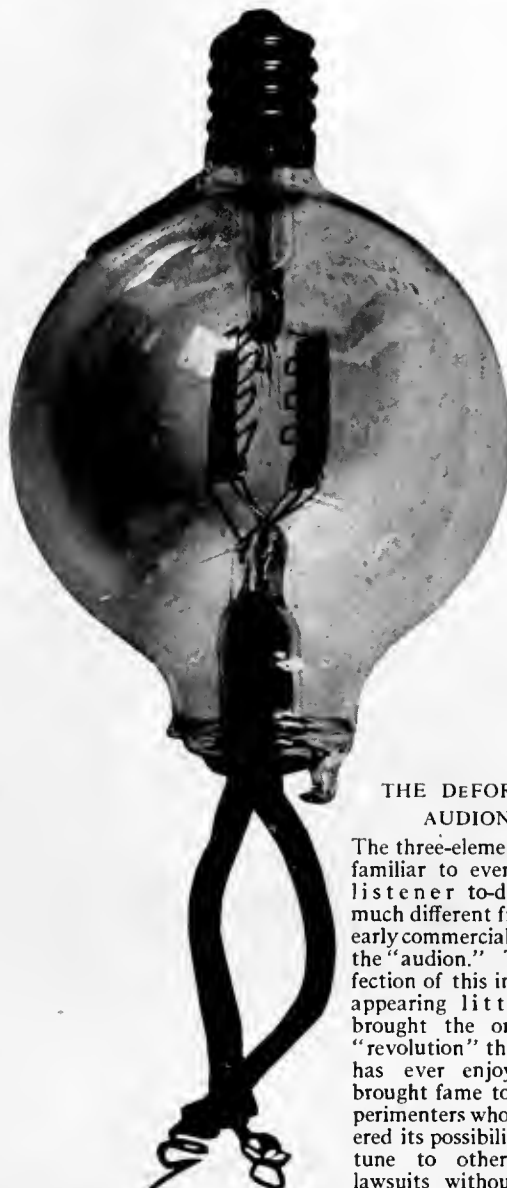

THE DEFOREST  
AUDION

The three-element tubes familiar to every radio listener to-day look much different from this early commercial form of the "audion." The perfection of this innocent-looking little bulb brought the only real "revolution" that radio has ever enjoyed. It brought fame to the experimenters who discovered its possibilities, fortune to others—and lawsuits without number, and the end is not yet

© Paul Thompson

island in the South Seas, I could doubtless compose my soul sufficiently to write a poem worthy of the theme, but our New York subway is not conducive to poetic rhapsodies. There has been altogether too little poetry on radio from its beginning, but perhaps the poetry has been in the accomplishment itself."

The frail glass bulb, safe on the laboratory table at Highbridge, incidentally suggested to DeForest the story of his invention for so many dark years laughed at and scorned as a useless toy by investigating lawyers, telephone experts, men of science, engineers, captains of industry and their capitalists. Doctor DeForest's early experiences merely repeated the story of the flying machine, the locomotive, the moving picture, the talking machine, the power-driven car, the submarine, all, in their early stages, merely wild tales of the imagination fit only for the readers of a Jules Verne.

It was in the summer of 1912, already having lost two fortunes, that DeForest, at work on a meagre salary in California, went to the president of the company to borrow \$125. DeForest wanted the money to perpetuate the life of audion patents held by him in France. In payment, he offered half his interest in the French rights. The president heard the offer but thought it too much of a gamble and then, to the despair of the inventor, the rights reverted to the French Government. Then came the war, and the audion took its place as the very heart of radio communication. Countless bulbs were supplied to the allied armies in France.

"One million dollars is a conservative estimate of the royalties

which would have been paid us by the manufacturers during the period of the war alone," said DeForest recently. "But, unfortunately in 1912, my friend the president, thinking that I was only dreaming, withheld his one hundred and twenty-five."

Was it lack of faith in the dream of the young inventor, or failure to see the march of progress? The name of the president will not go down to future generations. Nor is it fair to put him in a class by himself. With him may be named a score of others who blindly shut the door on fortune appearing in the guise of our rather ambitious young inventor. We might include in this group of mentally near-sighted the following:

The eminent directors of an early wireless telegraph company.

Telephone experts of 1908, 1909, 1910, 1911.

An eminent professor of electrical engineering instructing the student, DeForest.

Some well-to-do college classmates.

The executives and attorneys of a leading American telephone company.

A learned district attorney who solemnly proclaimed the audion to be a worthless "piece of glass."

It was early in the history of the wireless telegraph that worldwide recognition was given DeForest as a pioneer. In this period of invention came the birth of the audion. The audion was a lamp about the size of an Edison bulb.

#### HOW THE AUDION WAS NAMED

THE tube contained a filament, a grid, and a plate. DeForest made up a name for it, he took the word "audio," to hear; and "ion" meaning one or more electrons, and combined them into the one word—"audion," the three-electrode vacuum tube. It is the "talking" or "listening" lamp.

The first patent on the audion was assigned by DeForest to an early American wireless company. But this company got into trouble. Rather than have anything more to do with them, the inventor turned in his stock holdings and took in exchange certain patents which the company considered of no particular value. Among these were the first audion patent applications. How much are the exclusive rights to these patents worth to-day? Ask these former directors of the early American wireless company, or the corporations to-day operating under the audion patents!

Just about this time, when "some care-

less hand was tossing aside the audion" DeForest appeared before the New York Electrical Society to report on the development of his lamp. Telephone communication, in those days, was limited to a comparatively few miles. The Electrical Society meeting was widely advertised, and among those present were tele-

phone engineers. Their company at this time had paid \$400,000 for another device which they hoped would aid long distance operation. But this other device failed to do the job.

"My address," says DeForest, in recalling this experience, "included a detailed description of my numerous patents, even including one taken out in January, 1907, for amplifying weak telephone currents. The audion amplifier patent indicated very clearly the service that the audion could perform as a telephone relay or repeater, the result of experiments which I had been conducting in the summer of 1906 on the top floor of the old Parker Building on Fourth Avenue, in New York. The telephone engineers heard my story but were skeptical—too skeptical for words. One, two, three, four years elapsed—years thrown away. It was not until 1912 that I at last succeeded, through a friend, in getting an opportunity to demonstrate the audion relay before the telephone company. With the audion, in less than two years, they opened telephone service across the continent."

So much for the telephone engineers of 1908, 1909, 1910, and 1911. But these men of science were not alone in shutting the door on the efforts of the young inventor.

"HE WILL NEVER AMOUNT TO ANYTHING"

MANY years earlier along came the professor of electrical engineering in the university where DeForest had set out to write his thesis on the "Reflection of Hertzian Waves Along Parallel Lines." One night, while the student was working in a basement laboratory, the lights in a classroom went out. DeForest was suspected of having removed the wrong fuse. Shortly afterward the professor discovered that DeForest had committed the grave crime of nailing his apparatus to a laboratory table. That was too much.

"Any student who will spoil a table like that," said the professor, "will never amount to anything."

DeForest pleaded the value of his work and what he hoped to accomplish, but the professor was firm, and out went the student. He wanted his Ph. D. and at length succeeded in being enrolled in another department of the university, where, incidentally, Morse did his early work on the telegraph. But at least the table was saved from the earmarks of the "worthless student."

Recently DeForest, attending a class reunion, was approached by a friend of earlier days.

"Is there still any money to be made in radio?" asked the classmate.

DeForest smiled. "Have you forgotten," he said, "not so many years ago I came to you for the loan of a few hundred dollars saying there was a fortune to be made in putting the audion on the market?"

"No, Lee," replied the other, ruefully, "I certainly slammed the door on fortune."

In the year 1917, the telephone company which paid the first \$140,000 for rights to the audion entered into negotiations for further patents. The audion in the meantime had grown from a mere child of imagination to a good-sized boy. It was being used in many different ways. It picked up



MAKING MODERN VACUUM TUBES

The name of Doctor DeForest is always linked in the mind of the radio man with the three-element tube, although he was responsible for many other developments and perfections in radio, most of which had hard financial sledding, as Mr. Thompson suggests in this article. The early vacuum tube was made in small quantities and no two of them were electrically alike. This illustration shows how the more modern types of transmitting tubes are made. The tubes are slowly pumped out, so that almost no gas remains



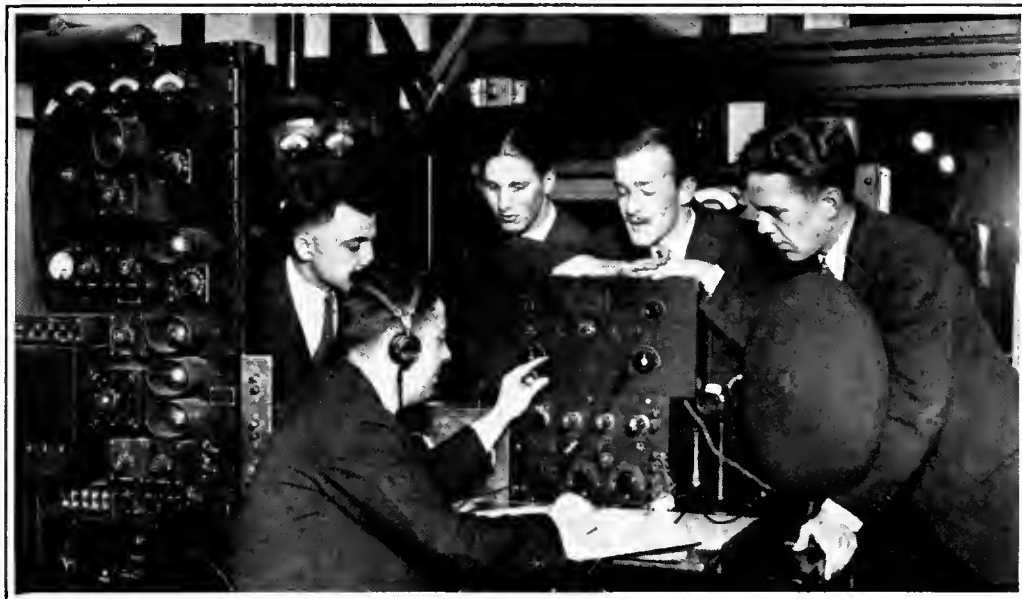

IN A BROADCASTING STATION

Three-element tubes, whose use was originally discovered by Doctor DeForest, are used at every stage of both sending and receiving

wireless dots and dashes across the seas. It carried the human voice on the telephone wires across continents. It had also entered the business arena as an oscillator. In other words, it had almost become a competitor of the huge alternating generator of our modern power houses. The sum of \$250,000 was finally agreed upon for the additional rights.

At last the attorneys and officials of the telephone company were satisfied. One of them said to the writer:

"We have all there is to have now under the audion patents."

"Yes," I interposed, "but not the exclusive right to sell radio sets to the public. DeForest retained that right."

"But what does that amount to?"

To be sure, in 1917, the right to sell to the "amateur" as it was designated, meant very little. In those days radio broadcasting was a joke. But, in less than three years, the country was inoculated with

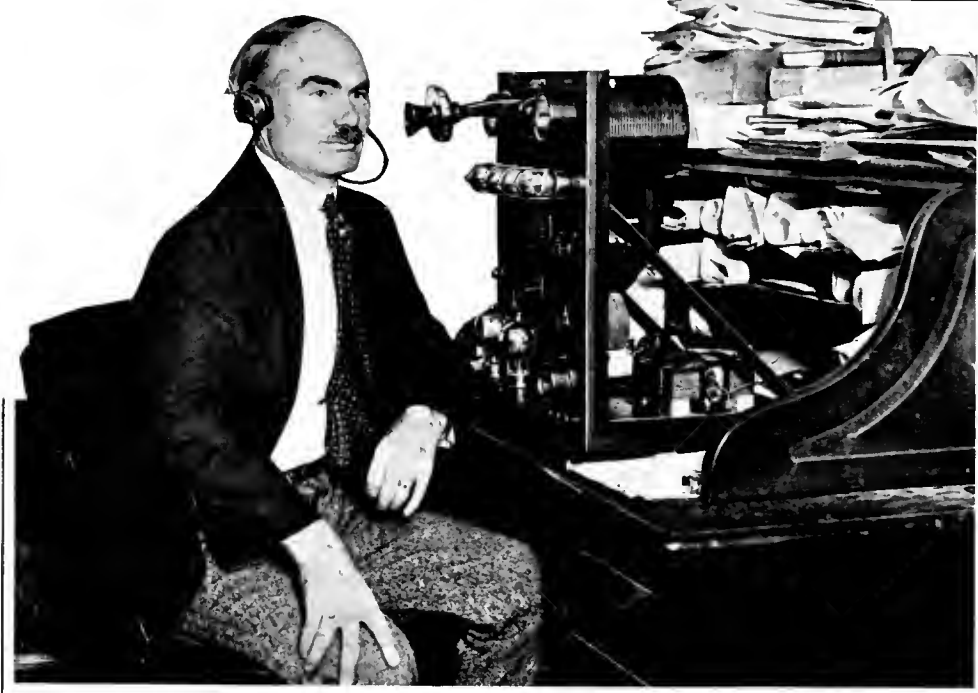
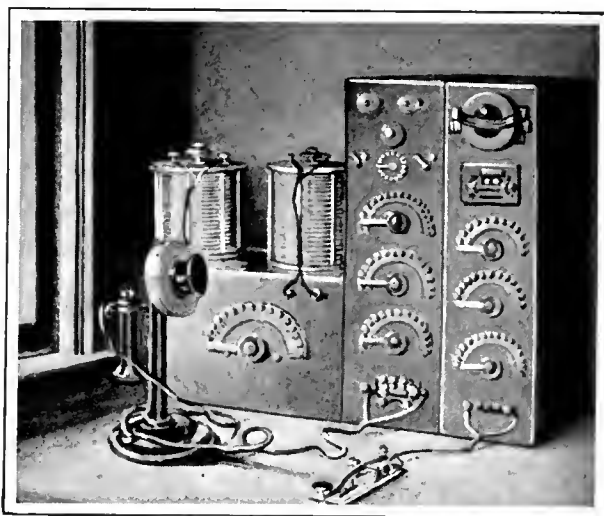

DR. LEE DEFOREST AND HIS "WIRELESS TELEPHONE"

© Western Newspaper Union

As long ago in radio history as 1919 this outfit was announced to the public as the "last word in wireless telephony . . . destined to become quite popular in these uncertain days of telephonic ills." The vacuum tubes used in this model can be clearly seen. The sketch to the right, above, is a charcoal drawing of early wireless telephone and telegraph apparatus used by Doctor DeForest at a station in Washington. Its appearance is quite different from the large broadcast transmitter of to-day

radio. Last year the "amateur trade"—so-called—spent nearly four hundred million dollars on "the joke."

"A PIECE OF GLASS—WITHOUT MERIT"

PERHAPS the first prize in this competition for those who blindly shut the door on the young inventor should go to that eminent gentleman who many years ago occupied the position of district attorney in one of the Eastern courts. The device conceived by the young inventor chanced to be an exhibit in a trial of some corporation directors who proclaimed it to be a wonderful invention. They were selling stock in order to promote the use of the audion in the world of art, industry, and communication. They had been indicted by the grand jury, together

with the inventor, and stood facing a term in Atlanta.

But listen to the District Attorney:

"They would have us believe," said he in summing up, "that this little thing is a wonderful instrument of science. They are appealing to the public to subscribe to their stock. But let me tell you, gentlemen of the jury, they are preying on the minds of ignorant and simple people. This device is without merit. It is not a wonderful invention. It fails to perform the many marvels they claim for it. It is a piece of glass which has been built into the form of a lamp, not to perform scientific wonders, but to sell stock. I ask, therefore, that you bring in a verdict of guilty for all those who have been concerned with this palpable fraud."

One or more of the defendants were found guilty and actually went to the penitentiary, not altogether, perhaps, upon the question of the merit of the "piece of glass" but more likely because of their misuse of the mails in selling the stock of the corporation. The inventor was acquitted.

"In the audion," said Edison some years after the courtroom scene, "De-

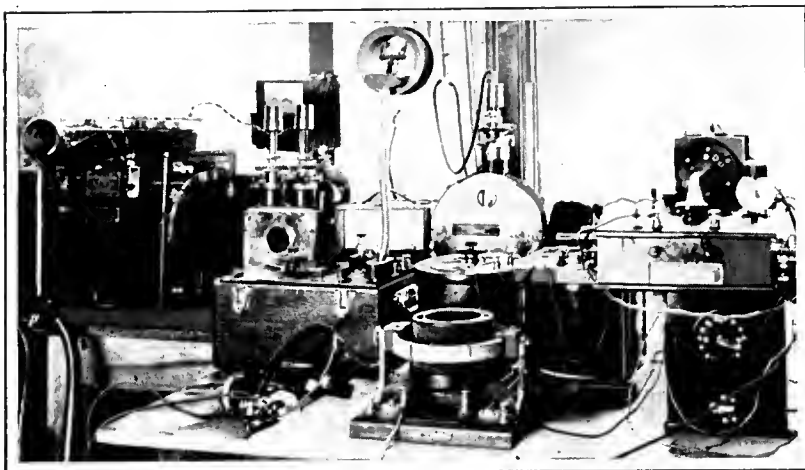

#### HISTORIC WIRELESS APPARATUS

This view was taken in the DeForest laboratory and shows some early experimental apparatus. At the left is an early model of a wireless telephone, using an arc instead of vacuum tubes for power. In the center is a model of a "picture machine" and at the right a crude receiver. A vacuum tube (inverted) can be seen on the top of the cabinet

Forest has invented a device which amplifies sound so much that if a fly were to walk across the transmitter, the noise at the receiver would shatter your eardrums!"

Had these various gentlemen no prophetic inkling to stir their imaginations? Publicly the first radio broadcasting took place at Put-In-Bay on Lake Erie, July 15, 1907, at the regatta of the Inter-Lake Yacht Association, when the reports of the yacht race together with gramophone selections were reported by radio. Not many months later, audion bulbs were installed on the radio telephone receiving apparatus used by the fleet of Admiral "Fighting Bob" Evans in his noteworthy cruise around the world. Even as early as 1907, we had plenty of demonstrations of what might be accomplished in the transmission of news and music by radio. In May of that year the inventor announced: "Church music, sermons, lectures, etc., can be spread abroad by the radio telephone. In rural districts scores of individual radio telephone services can be main-



#### IN THE EXPERIMENTAL DAYS

A portable wireless telephone transmitter being tested in the fields near Newark, New Jersey. The operators were never certain in those days just how far their signals would travel; uncertainty was the one certain thing about wireless then. The outfit is one built by Doctor De Forest

early radio experimenters. Now at last we may well sing with the poet of the Pacific:

#### FLOTSAM

Wave-borne, a fragile thing of glass and wire  
Past the grim reefs that guard a lonely land  
The audion drifted. Balked of its desire.

The spent sea washed it on the level sand,  
But we can fancy countless days you watched the ships go by—  
The months, in idle drifting spent beneath a tropic sky!



#### IN AMATEUR STATIONS

Three-element vacuum tubes are widely used. Years ago, in 1912, an employer refused Doctor DeForest \$125 to renew his "audion" patents in France so the rights reverted to the French Government, and perhaps a fortune was lost. Elizabeth Zandonini, owner of station 3 CQ, Washington, is shown at her set. She is a radio aide at the Bureau of Standards



# THE MARCH OF RADIO

By *J. J. Morecroft*

Past President, Institute of Radio Engineers

## Shall We Have A National Radio Council?

**W**E HEAR so much about various organizations nowadays, with their innumerable committees and sub-committees, that our natural reaction toward bringing into existence a new society is negative. Most of the hours that can be spared from our necessary daily tasks seem to be used up in committee meetings and discussions of one sort or another.

"Don't do it" was our first reaction to a suggestion for a national radio council made by the Radio Manufacturers Association. The society is active and influential; its members constitute many dependable radio manufacturers. Naturally any activities which bring about an increased interest in radio will be reflected in greater sales of apparatus, and it is undoubtedly the prime object of the Radio Manufacturers Association to bring about just this result.

We can look at the proposal of the Radio Manufacturers Association in just the same spirit as we consider the activities of the National Automobile Chamber of Commerce while primarily they are looking out for their own good, their vision may be broad enough to take in the idea that any movement which makes radio more pleasurable for the listeners increases their sales to just the same degree. The elimination of

interference, the improvement of programs, and all such activities might well be forwarded by the manufacturers association.

The report of the R. M. A. was evidently drawn up in the liberal spirit we have alluded to. A national radio council is recommended, whose function is not primarily to bring about increased sales for the manufacturers but rather to improve the radio situation as a whole. Among other things, Mr. Frank Reichmann, chairman of the R. M. A. committee, says, "We recommend the establishment of a National Radio Council to be composed of representatives of the Radio Manufacturers Association, dealers and jobbers, manufacturers' agents, the broadcasters, radio publications, and the listeners.

We are advised that the National Radio Trades Association, which has done much excellent work in the past, is anxious that the manufacturers get behind an organization of the dealers and jobbers. We understand that the National Association of Broadcasters is willing to help in organizing a central council, and we are assured that we will have the active support of the two leading listeners' organizations—the American Radio Association and the Broadcast Listeners Association of America.

We are also of the opinion that the American Radio Relay League should be invited to become a member of the council and we can promise that the Farm Radio Council will join.

This committee also recommends that the association take up the matter of further encouraging the teaching of radio in all manual training classes in all public and private schools.

This committee believes that by careful, conservative action during the coming year a great deal can be done to cement together all those interested in radio, to the end that the industry will be better prepared to repel legislative and other attacks, and that even greater public interest in radio will be assured.

### What the "Straight Line Frequency" Condenser Means

**W**ITH the increase in use of the term frequency, rather than wavelength in radio broadcasting ideas and practice, the straight line frequency condenser has appeared on the market and there seems to be considerable misunderstanding as to what and why it is.

It is not long since we made comment on the "low loss" condenser, a term which was invented by some astute radio business man to increase his sales. As we pointed out at that time "although some condensers do actually have lower electrical losses than others, due to better materials used for plates and insulation, the difference is so slight that any one of a dozen reputable condensers would show up equally well when connected in a receiving set." The



H. W. ARLIN

Chief Announcer at station KDKA, East Pittsburgh, holding a large water-cooled ten kw. transmitting tube in contrast to the piezo-electric crystal. This quartz crystal has the property of vibrating when properly excited at radio frequencies. It is inserted in the KDKA transmitter and holds the transmitted frequency very accurately on the proper adjustment

difference in loss of various standard condensers is so slight that accurate laboratory measurements are required to show it.

Not so, however, with the straight line frequency condenser; the use of such a condenser in radio sets is a real advance in the radio art. The assignment of various channels to different broadcasting stations is made because each station requires a definite number of cycles for its own use; the proper number depends upon the quality of the broadcast material, but in general it may be said that no station should be assigned a frequency within ten kilocycles of another located sufficiently close to interfere with the one in question. Thus if there were ten stations in one district they would naturally be assigned channels equally spaced in frequencies, say twenty kilocycles apart, and if the set being used is equipped with straight line frequency condensers these stations will be found at equally spaced points on the

tuning dials. With ordinary condensers of course this is by no means possible, for only one or two stations are found at the higher points of the scale, where at the lower end of the scale the different stations come in at points so close together that it is difficult to set accurately for them. These new condensers, however, show one station at 5, another at 10, another at 15, etc., all the way up the scale, and their use makes a set considerably easier to manipulate.

### The Progress of Broadcast Relaying

**A**N ANNOUNCEMENT from KDKA confesses that what they call a new scheme of relaying has been tried out and found to be satisfactory. The Westinghouse station at Hastings, KFKX, which has been used as a relay outfit for quite some time, has ordinarily been operated on a different frequency from KDKA, so that any one midway between Pittsburgh and Nebraska might receive the same program from either station, providing he retuned as he wanted to listen to one station or the other. To operate both stations at the same frequencies brings in some technical difficulties, according to the engineering staff of

the Westinghouse Company, but recent improvements have overcome these troubles and now they say that both stations may be operated at the same frequency. The feat may have more promise than we now think it has.

It also said that the frequency of KDKA is now being held constant by the use of a piece of piezo-electric quartz. As we have related in these columns before, a small piece of good quartz crystal, properly cut and arranged in an electric circuit, will hold the frequency of oscillation so constant that no present methods can detect any change. The use of this frequency fixing scheme of KDKA seems much more important to us, as far as the March of Radio is concerned, than the rebroadcasting stunt mentioned above and about which such sweeping claims are made. We are interested to note that the other Westinghouse stations are soon to be equipped with quartz frequency stabilizers. This technical advance might well be followed by many other stations which evidently experience some difficulty in maintaining their frequency.

### Radio for 1926: A Forecast

**C**ARL BUTMAN has just completed an extensive survey of what the radio listener wants for 1926. His findings are in accord with what we have urged on our readers for quite some time.

The DX fan, the man who continually manipulates dials to see if he cannot catch the last letter perhaps of a station 500 miles farther away, is rapidly disappearing. He was ever a nuisance, this distance seek-

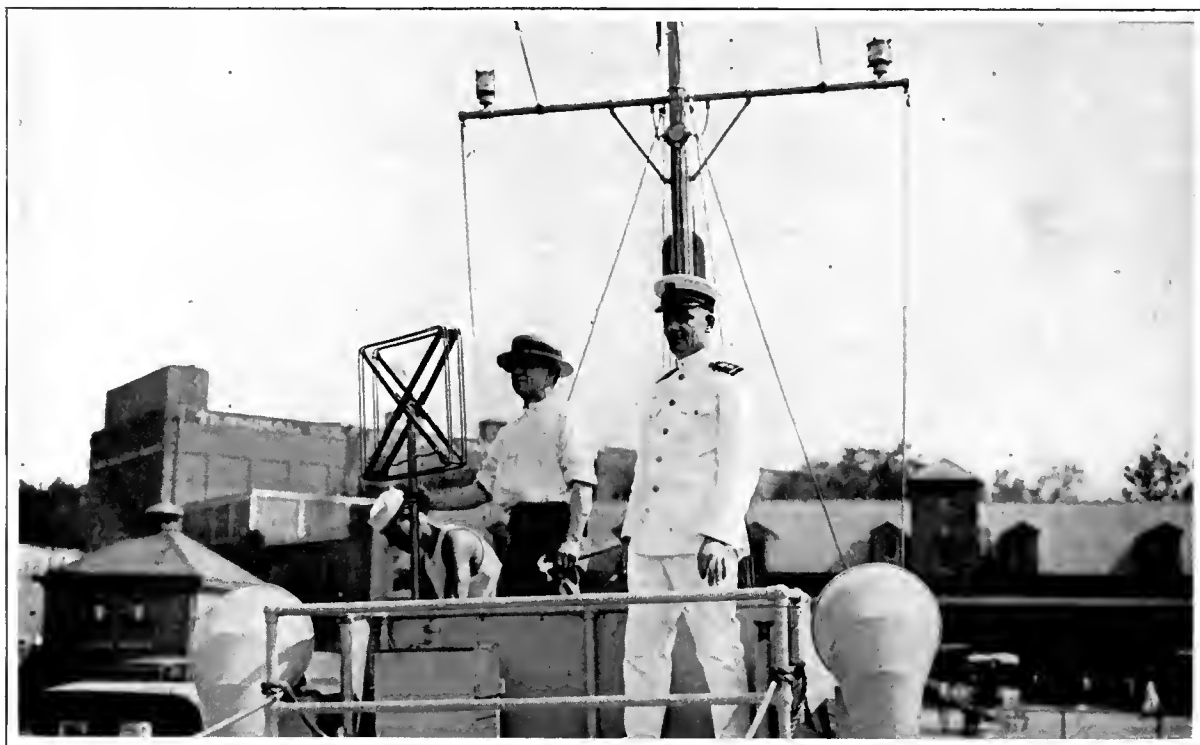

© Harris &amp; Ewing

### RADIO DETECTIVE EQUIPMENT ABOARD A RUM CHASER

The radio direction finder installed on the bridge of the CG198. It is said that many of the rum runners off the American coast are using radio to help them in their operations. The direction finder, as used by the "Dry Navy," is expected to be of great aid in locating the rum ships. The large carboy in the foreground supposedly contains distilled water

ing fanatic; no sooner had the radio set been tuned to one station and the call letter heard than he was off for another. A kind of sport it was, to be sure, but in the main, radio is to give entertainment to the family from stations close at home.

With the slow disappearance of the dx listener, the survey finds an ever-increasing demand for quality reception. Many people are just awakening to the realization of how very poor is the quality the loud speaker delivers and this has resulted in an insistent demand for faithful reproduction. As was said in these columns many months ago, it is very seldom that a radio loud speaker leads us to believe that the speaker is actually in the room and until this is so the goal, an attainable one, has certainly not been reached. Any skilled radio engineer can, if he has suitable laboratory facilities, develop a set which will amplify properly throughout the whole audible scale and from such a set, after the loud speaker manufacturers have much improved their product, reasonable quality may be expected. The present horn is eventually doomed to the radio scrap pile, we believe and the diaphragm type or possibly something better will take its place.

A growing tendency toward simple control is shown in the new sets and it seems that two-dial sets will soon predominate in the market. The simple regenerative receiver is on the down grade and the tuned radio frequency five-tube receiver seems to be the one most favored. It is well to point out that to get good quality with loud speaker reception, the ordinary small tube as used to-day must be done away with; it cannot possibly deliver enough power for the ordinary loud speaker to handle. In the new sets we are glad to see a new type of tube used in the last audio stage.

Quality is undoubtedly the keynote of progress for the sets of 1926.

### The Radio Business as Others See It

**T**HE Copper and Brass Research Organization, whose function is to compile all information useful to companies dealing in copper and brass products, has recently given out a summary of its investigations of the radio business. It is interesting to note that the estimate of the value of the coming year's radio business, and number of sets already in use, etc., compare quite closely with some other figures at hand compiled from the past reports of the Bureau of the Census. The Bureau reports are not brought up to date because compilations are made only every two years.

According to the Copper and Brass Association, "Manufacture and sale of radio receivers has established a record for rapid industrial expansion. In 1922 there were hardly 100,000 radio sets in use; in 1923 the number had grown to 2,000,000; in 1924 to 3,750,000, and by the end of 1925 it is estimated that the number of sets in

use will reach a total of 5,000,000. The retail value of sets and parts has grown from \$50,000,000 in 1922 to an estimated \$500,000,000 in 1925.

Public interest in radio has gained rapidly and apparently has continued unabated. Only a year and a half ago the consumer demand was far in excess of the manufacturers' ability to supply. At that time the number of home-made sets exceeded the factory-made, and there was a correspondingly large retail market for radio parts of every description. The last year has seen the beginning of something like stabilization in the industry. The trend of sales is now away from the home-made set and toward the set purchased as a complete unit.

The present rate of manufacture, according to the Association's survey, indicates that 1925 production will be 2,000,000 sets in which the consumption of copper and brass will be about 7,750,000 pounds. These metals are used for antennas, ground connections, coils, condensers, tube sockets, panels, and miscellaneous small parts. The interesting report continues:

Radio now appears to be as universal in its appeal and as much a necessity as the automobile, so there is no reason to look for any falling

off in sales in the next few years. The radio purchaser is not only a good customer for tubes, batteries, plugs, jacks, and other miscellaneous parts, but almost generally he is ready, after using a set a year or two, to scrap it and replace it with another which has a more stylish cabinet or a newer "hook-up" or more tubes. Consequently both replacement and new set markets increase together with the market for parts and accessories.

A review by Mr. Carl Butman of Washington suggests the interesting note that in 1923 the average price of a radio outfit was \$16, in 1924 it was \$50, and to-day it is a hundred dollars or more. This higher priced equipment is not going to the high-salaried city dweller only, but the agricultural communities also show the same evidence of giving up the old five-dollar home-made set in favor of one which performs more reliably and has a more pleasing appearance.

Both of the reports place the probable number of receiving sets in the United States for 1926 as five million or over. When nation-wide broadcasts are carried out next year, therefore, it is evident that the potential audience is certainly measured in the millions, possibly ten or even more.



© Bell Telephone Laboratories

WILLIAM G. HOUSEKEEPER

An engineer of the Bell Telephone Laboratories who was recently awarded the John Scott Medal by the City of Philadelphia for his contribution to technical progress. The award carried with it a \$1000 prize. Mr. Housekeeper was responsible for the metal-glass seal in large vacuum tubes. Previous to his discovery, it had been almost impossible to make large vacuum tubes because of the difficulty of bringing out large leads through the glass. Mr. Housekeeper is here shown in his laboratory with one of the large tubes. Note how small the lead wire is made just where it passes through the glass

## A Year of Conferences

THE International Radio Conference, many times delayed, is now to be held in Washington next spring. Not since the last international conference was held in London in 1912 have the various nations interested in radio met to discuss its problems. Invitations have now been sent out to forty-two different governments, asking them to send delegates to America in the spring of 1926. Congress has appropriated \$92,000 to defray the expenses of the conference, and outlines of the work to be covered have already been laid out. The subjects to be discussed include the revision of the International Radio Telegraph Convention and Regulations, the discussion of measures for the international supervision of communication by radio between large fixed stations, broadcasting, measures for elimination of interference, distress messages, radio aids to navigation, and other developments of the art which have come into being since the 1912 conference.

As this is written there is being held in Paris the International Telegraph Convention. The United States is not officially a party to this conference and our delegates will be seated as observers only. Three attended. In addition to these, certain of the government technical men

are being sent and the telephone, telegraph, and cable companies of America have many representatives in Paris to advise with the government representatives and their aids.

In addition to these two conferences, Secretary Hoover will probably call the regular annual national conference for some time in November. He rightly feels that the previous Washington conferences have been of value to the department in framing new policies and that this year especially, when there are many stations increasing their power, it will be well to test public feeling toward these more powerful stations. One station is already operating experimentally with fifty kilowatts, another is prepared to do so, and there are several operating at five kilowatts. The use of these greater powers has by no means resulted in the confusion and interference which many panic-stricken listeners predicted and it seems quite likely that this national conference will put its stamp of approval on the super-power channels.

The radiating receiver should get its share of adverse comment at the Washington conference. Listeners continually complain of these miniature broadcasting stations. We strongly urge the Department to put its official stamp of disapproval upon this prolific source of radio discomfort.

## The Month in Radio

PRELIMINARY reports of the operation of the 50 kw. wgy transmitter givesomevery interesting, though not startling, information. Comparative tests were recently carried out first with 2.5 kw. and then with 50 kw., that is, twenty times as much power as the first. Many listeners had expected that so much power would completely blanket other stations, but was not found to be the fact; the results so far obtained show that theory is able to predict what will happen at the higher powers and in this case the theory indicated that the blanketing effect would be pronounced only when close to the high-powered station. Listeners fifty miles away from one of these high-powered stations will probably be disappointed to find out how strong the signals really are; the signal will be about the same strength as from an ordinary station about ten miles away.

The useful area of transmission of the super power station is very much increased over the low powered station of course, and the quality of reception is improved because of the higher ratio of signal strength compared to static.

Much trouble is experienced by the average listener fifty miles or more away from a station due to the now well-known fading effects; the rapid waxing and waning of signal strength makes many radio evenings very disappointing. It had been supposed by some that fading would be lessened when the high power was used but such proved not to be the fact. The signal is of course much more audible with the higher power but its fading is just as pronounced as with the older lower powered sets.

THE cruise of our fleet through the southern Pacific has given rise to some remarkable distance events. The U. S. S. *Seattle* in the harbor at Wellington, New Zealand, has heard telephone conversations with a London amateur with remarkable regularity. The distance, slightly more than 12,000 miles, is as far as a radio telephone message can be transmitted on this earth. The operator on the *Seattle* has also maintained two-way communication with the naval experimental station at Bellevue as he crossed the Pacific from Honolulu to Australia. The Laboratory of RADIO BROADCAST station 2 GY communicated with the *Seattle* while she was leaving Tahiti. Our station used only a 5-watt tube, which is thought to establish a record for 5-watt transmission.

THE American consul in Paris, reporting to the Department of Commerce, sees but little market for American receiving sets in that country. So far, he says, broadcasting in this section has become popular only in a small degree compared to the situation in America. There are only four stations broadcasting, all of

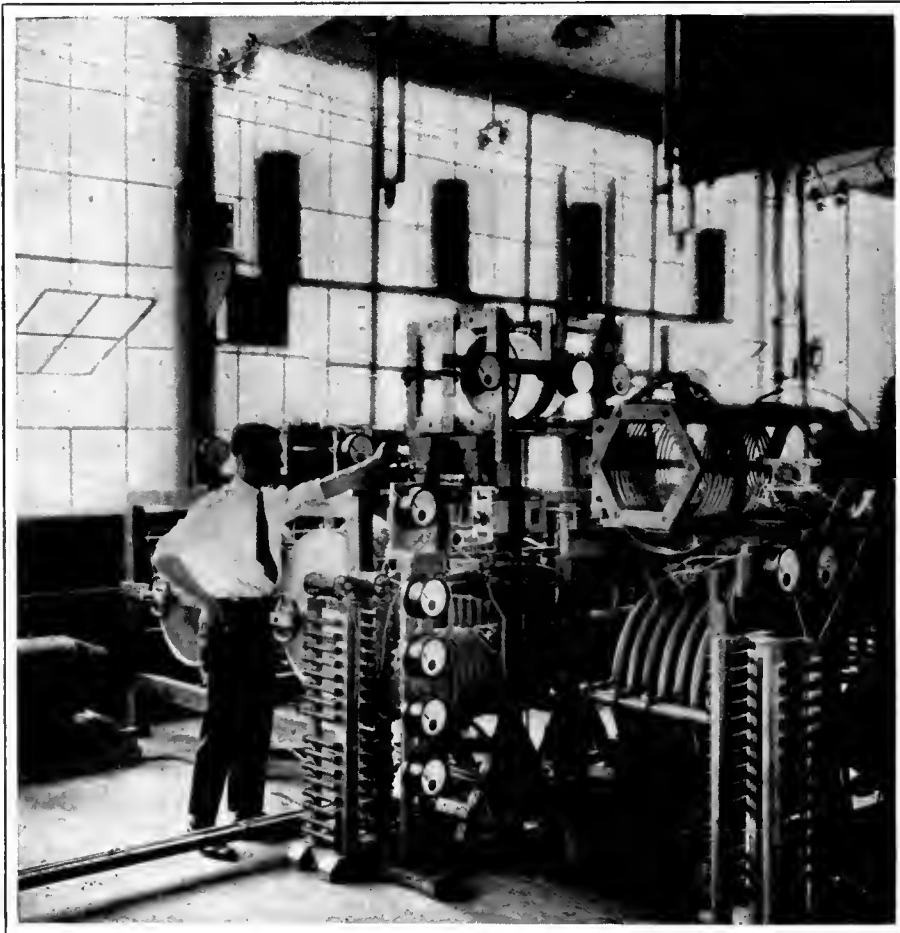

THE FIRST AMERICAN "SUPER POWER" BROADCASTING STATION

The 50 kw. transmitter at station wgy, Schenectady. Recent tests were made to determine whether better program service could be given listeners if the power of the transmitting station were greatly increased



JOHN V. L. HOGAN  
New York; Consulting Radio Engineer

*"The report, recently made public by Secretary of the Navy Wilbur, relating to the work of the Naval Laboratories, which seemed to point to the possibility of the expensive high-powered, long wave stations now used for inter-continental radio communication being replaced by less expensive short wave, lower powered stations is especially interesting. The conclusions are quite in line with the recent reports on the same subject made by Dr. Alexanderson, of the General Electric Company at Schenectady. It is difficult to say definitely that the present high power, long wave stations will be replaced by the short wave transmitter because the short waves are not always reliable. However, there seems to be no doubt that they will be valuable adjuncts to the powerful long wave stations."*

some time his death was regarded as a mystery, but careful examination of the radio installation on his plane indicated that defective insulation in the headphones and other parts of the transmitting set had permitted a shock of over one thousand volts to pass through his head. As a shock of only twenty or thirty volts around the head is extremely painful it is no wonder that the leakage of the thousand volt current into his ears was fatal.

**I**N BRITISH India, the government retains the right to supervise and inspect all broadcasting stations, censoring them and taking them over in emergencies. It is also required that each station, as in the United States, shall have a receiving set in continual service while broadcasting. Government matter, such as weather reports, educational lectures, and emergency dispatches must be handled free. No program can have more than ten per cent. of its time used for advertising purposes.



L. A. HAZELTINE  
Hoboken; Professor of Electrical Engineering

*Interesting Things  
Said Interestingly*

**J**OHN McCORMACK (London; Irish tenor): "I shall retire at 50 and from now on shall come to London each year to sing in the Albert Hall. However, I emphatically refuse to broadcast. I tried it once in New York and disliked it thoroughly."

**A.**L. RUBENSTEIN (New York; chief operator of the S. S. *Arcturus* with the recent William Beebe scientific expedition): "While we were in the Galapagos the broadcasting station that came in best was WMBF, at Miami Beach, Fla. Ordinarily we couldn't get New York. But on one occasion we asked the East Moriches station to request a certain concert from an orchestra in a Greenwich Village restaurant. The music we asked for was put on the air by WGBS, and came through with remarkable clarity, considering the distance and atmospheric conditions."

**H**ERBERT H. FROST (Chicago; president Radio Manufacturers Association): "In the early part of 1917 I was assigned to the command of a radio company of one of the Regular Army Field Signal Battalions, and found that out of a total strength of seventy-six men in this company, 52 of them were licensed amateur operators who had enlisted at the first call, and I know of one town in Pennsylvania that gave 11 amateurs to the Signal Corps out of a total of 13 licensed members who were residents of that city. The American amateur and the American Radio Relay League have made their bid for fame, and stand before us today richly endowed with a past record in both peace and war. It is not too much to say that the experimental work they are now doing on short waves will revolutionize our present systems of transmission and reception over great distances.

**J**OSEPH D. R. FREED (Brooklyn; president Freed-Eisemann Radio Corporation): "I firmly believe that all kinds of freak circuits will be exploited within the next two months. The public should be warned against

*"I would not advise any young man to attempt a short cut into radio engineering. The ordinary electrical engineering course should be sufficient, if followed by practical experience preferably with a large organization, or by post graduate work at college, the latter more especially for the man having a taste for research. My own collegiate work was simply the mechanical engineering course given by Stevens, and I found it quite sufficient to build on by studying in my spare time. While one cannot expect the present exceptional demand for radio engineers to continue indefinitely, it would be equally a mistake to consider radio as a fad or in any way transitory. There should continue to be good opportunities for experience and advancement in radio fields, perhaps more than in other branches of electrical engineering. I still have the same feeling that caused me to take up radio as a specialty, that it is especially attractive to men having a fondness for mathematics and its practical application."*

high-sounding phrases and the mass of adjectives that will accompany reports of these circuits, such as used in hundreds of thousands of receiving sets, and the variations are only good for publicity, not as far as efficiency in reception is concerned. With so many receivers and with so many claims as to their merits, the public should study the situation very carefully. Surely, if freak circuits were really better, the leading manufacturers would be only too happy to use them in their regular lines, and to use the funds devoted to advertising these standard sets toward the boosting of the 'freaks'."

**R**OXY" (in *Broadcasting: Its New Day*, written in collaboration with R. F. Yates): "At the present time there are two changes that would rescue broadcasting from the shadow of disaster and place it on the solid footing it deserves. If half our better studios would cut down their broadcasting time and concentrate more upon quality than upon quantity, a very pleasing result would be the outcome. The second change would be that of converting some of the studios to a class basis."

them in Paris, and the number of listeners is probably less than we have in one good-sized city. The radio trade in France is of the opinion that from fifteen to twenty stations will be required to cover the country properly and that until such stations are erected and put into operation the number of broadcast listeners will remain comparatively small.

**L**AST year we exported close to \$6,000,000 worth of radio apparatus and this year shows a very decided increase. Judging by the value of the first half of the year's business it appears that our total radio exports for this year will exceed \$13,000,000.

**A** GERMAN court has recently held that not only has a tenant a right to erect an antenna on a housetop but that, owing to the importance of broadcasting, it is the duty of the proprietor to see that the tenant is enabled to put up an antenna on a house.

**O**NE of the flight sergeants of the R. A. F. was recently killed while conducting some radio experiments over the aerodrome at Andover, England. For

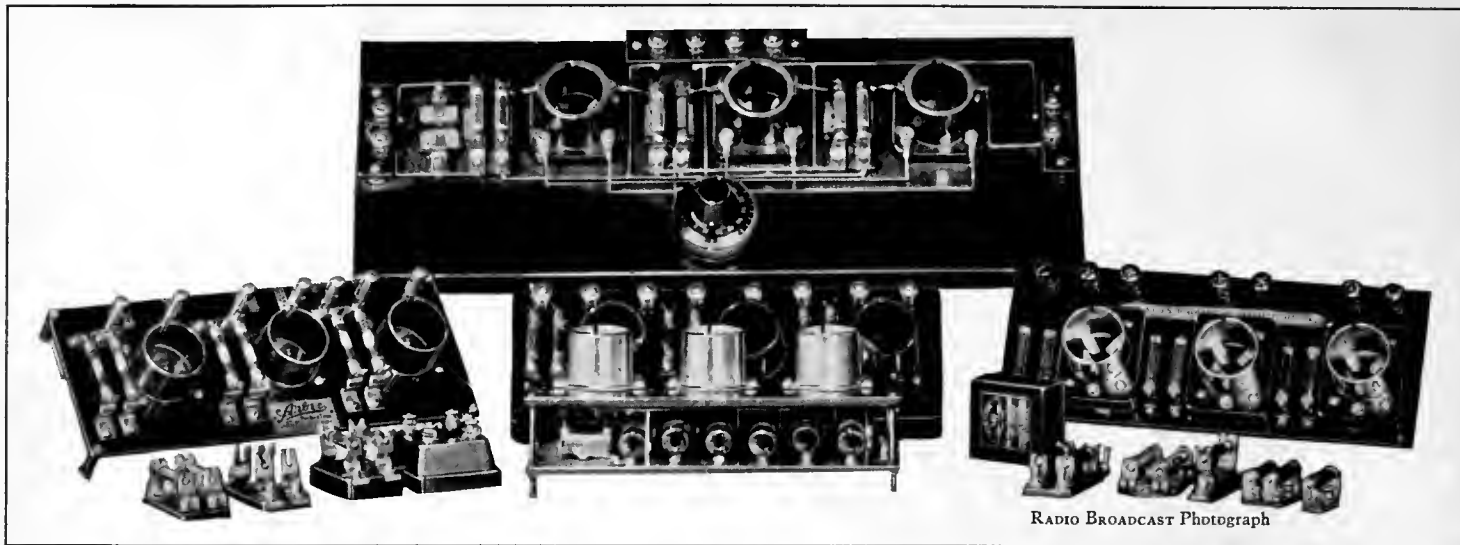

FIG. 1

Here are a few of the resistance units tried out in the RADIO BROADCAST Laboratory in conjunction with the development of the RADIO BROADCAST "Aristocrat." They include assemblies made by the Arbee, Electrad, Daven, Heath, and Crescent, as well as units from Cole, Brach, Muter, Dubilier, and Durham

# The Radio Broadcast "Aristocrat"

How to Build a Five-Tube Receiver Which Has Extremely High Quality, Especially Fine Selectivity and Sensitivity

By ARTHUR H. LYNCH

FOR a very long time we have been looking for the kind of receiver that would be easy to build, easy to operate, and at the same time be comparatively economical. In the receiver described here, we have found what we consider a solution to the problem. There is but one main tuning control which makes the finding of stations so simple that the most inexperienced can secure surprising results. In an actual demonstration, we have been able to show that by means of this single control and no other adjustments whatever we were able to hear sixteen stations in less than three minutes, with a single turn of the tuning dial. When other adjustments were made—and where is the DX fan who will not want to be certain that he is getting the last drop of energy out of his set?—we have been able to procure distance with volume, which few receivers other than a super-heterodyne could have accomplished. And above all we have been able to secure tone quality which has been characterized by many of the radio designers and enthusiasts who have come to Garden City to witness the performance of our new outfit, as being far superior to most receivers they have seen or heard. We believe this receiver will do much to endear radio to those music lovers who

up to the present time have felt that radio reproduction was not sufficiently free from flaws to reproduce with true fidelity the music they love.

## WHAT THE RECEIVER IS

IN COMBINING over the possible circuits of real worth to the home builder we have come to the conclusion that there are but three that possess the merits we sought, namely: the super-heterodyne, the neutrodyne in many of its advanced models, and the combination of a stage of tuned, neutralized radio-frequency amplification in combination with a regenerative detector and some more than ordinarily good system of audio-frequency amplification. After considerable thought to each of these we

decided in favor of the last, not because we thought the others less valuable but because the combination of price, distribution, ease of building, operating, and low upkeep cost seemed to be best carried out in the receiver we are now to describe.

So, in the RADIO BROADCAST "Aristocrat," we have one stage of tuned, neutralized, radio-frequency amplification, a regenerative detector, and three stages of resistance-coupled amplification. Before going further let it be said that the resistance-coupled amplification we are using should not be confused with similar systems described in the past because it is now possible to maintain tone quality, for which this type of amplifier is famous, together with great volume, because of the foresightedness of some of the tube manufacturers who are now marketing what are known as high-Mu tubes. These tubes are designed for resistance-coupled amplification. The amplification per stage that is obtainable with them is far greater than has heretofore been generally possible.

Then, too, in the "Aristocrat" there are no rheostats whatever and the number of binding posts has been reduced to a minimum. In order to make the design, building, and operation of this type of receiver quite clear, and in order to demon-

THIS article is one of the features we have worked on to produce for RADIO BROADCAST in its new form. In changing the size and improving the general appearance of the magazine we are at the same time making great efforts to improve the quality of every single contribution in it. This receiver, frankly, is one of the first to be presented anywhere to the home constructor which unmistakably takes the lead in what is destined to be the whole progress of radio fashion. The receiver described here, although it is not difficult to build, has practically but one control, and is extremely economical in battery consumption, has the crowning merit of delivering a signal of unusually good quality. Radio constructors are no longer content to assemble a receiver which has merely the merit of great sensitivity or selectivity, or some other familiar point of superiority. The constructor is demanding, and rightly, that his receiver give the most faithful reproduction possible of the transmitted voice and music. That is the keynote of radio fashion for 1926, and that keynote the RADIO BROADCAST "Aristocrat" strikes.—THE EDITOR.



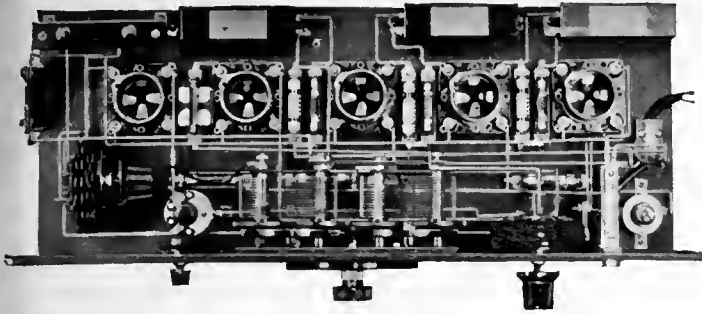

FIG. 2

In this assembly each unit is made with individual mounting. The antenna switch is behind the panel and .5 mfd. condensers are used in the resistance-coupled amplifier, and a short-circuiting switch is used on the ballast for the last tube to allow for use of either 5- or 6-volt tubes at will. The regeneration is controlled by a variable resistance across the tickler. A Cabelug is used for the battery wiring. For the experimenter who wishes to make frequent changes in his circuit this arrangement is just about ideal. The panel, by the way, is 7 x 21"

strate the variations that may be incorporated in it at the discretion of the home builder, we will describe at length but one of the group we have made, and will point out the differences between it and the others by means of the captions under the illustrations.

#### THE DESIGN AND ASSEMBLY

BY REFERRING to Fig. 5, it will be observed that there is but a single dial, in the center of the panel. This dial is used to control a Hanscom single control unit (first described in this magazine for October, 1925) and is the main tuning control. It is a unique arrangement of two Remler condensers geared together in a manner that makes tuning of the antenna and radio-frequency circuits simultaneous. The small knob below and to the left of the main dial is the vernier which is used to compensate for any slight variations between the windings of the circuits tuned by the two condensers. The knob below and to the right of the tuning dial is the filament switch. By referring to the circuit dia-

gram, it will be observed that the filament switch is placed in a position in the circuit that cuts out the by-pass condensers across the batteries, which would ordinarily form a high resistance leak and result in a drain on them even when the receiver was not actually in operation. The small knob at the left of the panel is used for the tap switch, connected to the primary of the antenna coupler, to compensate for antennas of different lengths. Once this switch has been set for a given antenna it need not be touched, except for ultra-fine tuning, when extreme selectivity or extremely long distance is desired. The knob on the right controls the regeneration, and may be considered a volume control.

Before passing on to the consideration of the remainder of the receiver it would be well to look over the accompanying illustrations and observe the variations that have been made in the panel design, the layout of the apparatus, and the different systems of tuning and regeneration control. There is very little difference in the actual performance of any of the models we have made and the selection you make may well be considered from a con-

venience standpoint rather than one of net results obtainable. Bear this in mind, however: you cannot expect to get the results we are getting if you buy your parts on nothing but a price basis. We have spared no expense in attempting to bring only the best to your attention and suggest that you make an attempt to get the best—not necessarily the most expensive. And when you are all through getting the best of parts and have done a thorough job in your building don't blame poor reception on the receiver if you hook some poor loud speaker to it.

But to continue, we may as well point out some of the other important points in the actual construction of this receiver. The panel of what we may consider our main model is 7 x 18 inches and there is plenty of room on it for all the equipment necessary, when a sub-base is employed. In this model we have used large-size inductances, in order to illustrate how the entire assembly may be housed in a standard cabinet. When other types of inductances are employed, as is the case in some of the other models, there will be a little more room in the cabinet.

It will be observed that the tuning in-

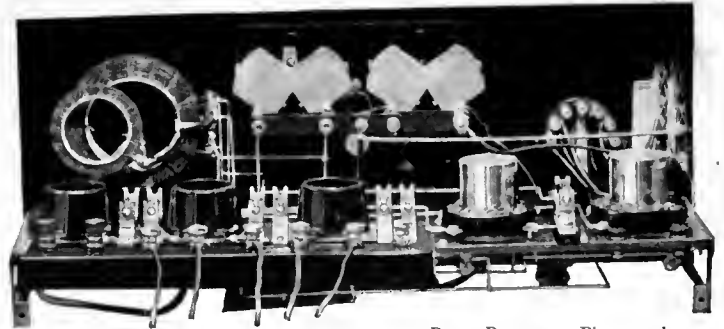

RADIO BROADCAST Photographs

FIG. 3

This receiver was made on a 7 x 18" panel and is intended to illustrate the method of using a complete resistance-coupled amplifier unit in connection with two additional tubes for the complete assembly. When 6-volt tubes such as Daven MU-20, and MU-6 are used, there is no need of making any alteration in the filament circuit of the amplifier, and the wiring is thus materially simplified. In this receiver we have used the regular Sickles Knockout coils. The ballast resistors for the first two tubes are shown beneath the sub-panel

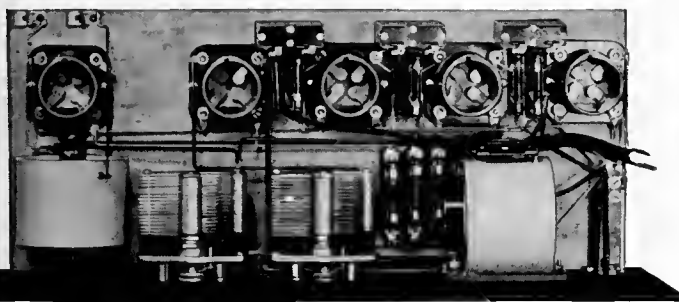

FIG. 4

On a recent visit to our laboratory Mr. McMurdo Silver built this receiver from the ground up in less than four hours. It is his version of the RADIO BROADCAST "Aristocrat." The single control feature is accomplished by belting two of his condensers together with fish line, letting one dial do all the moving. When it is desired to change the capacity in one circuit without altering the other, one condenser is held in place and the other turned. We are not as enthusiastic about this scheme as that devised by Hanscom, but it has enough merit to warrant attention. In this 7 x 18" receiver there is plenty of room, even with the large solenoid coils. The parts used include Hoosick sockets, A.B.C. panel, Accuratune vernier dials and knobs, Silver Knockout coils, .0005 S.L.F. variable condensers and .005 coupling condensers, Micamold coupling resistors, Muter mountings and grid leaks, Daven mountings and ballast resistors, Carter switch and jack and Belden battery cable



RADIO BROADCAST Photographs

FIG. 5

Front view of RADIO BROADCAST'S "Aristocrat" made to fit in a cabinet providing for a 7 x 18" slanting panel. In this receiver, as the accompanying article will show, we have gone a long way afield and produced what we believe is a true departure from conventional design electrically, artistically, and mechanically. It will operate over comparatively long distances, produce music with great volume and fidelity with the advantage of one major tuning control and remarkable economy.

ductances and the variable condenser assembly antenna switch and battery switch are mounted on the main panel, while all the remaining equipment is either on the top or bottom of the 2½ x 17½-inch sub-panel, which is suspended from the main panel by means of Benjamin No. 8629 brackets.

On the upper side of the sub-panel will be found the five tube sockets, the threeresisto-couplers, the grid condenser and leak mounting, and the variable neutralizing condenser. It is also possible to find room for all the binding posts, including those for the three connections for the C battery, if they are thought to be desirable.

On the under side of the sub-panel there are five mountings which are used for the filament ballast resistors, when they are to be used. When they are to be taken out of the circuit, as explained a little later on, it is but necessary to make a direct connection between the two spring clips of the mounting.

LIST OF PARTS

THE list of parts used in the model we are considering is as follows. The variation in material that is possible is indicated in the accompanying illustrations.

1 7 x 18-inch panel, 1 2½ x 17½ inch sub-panel, Hanscom S. C. Condenser Unit, 1 set Eastern Knockout Coils, 1 Carter filament switch, 2 Apex knobs, 5 Benjamin sockets, 3 Daven resisto-couplers with 3-.1 megohm resistors and 1 each, 1 meg., .5 meg., and .25 meg. resistors, 1 Hammarlund neutralizing condenser. 2 .004 Sangamo fixed condensers. 1 Dubilier .5 microfarad by-pass condenser. 6 Daven No. 50 mountings, 1 Daven Leakandenser (a new unit, which combines the grid condenser and leak), 5 Daven Ballast Resistors. (The capacity of these resistors depends on the type of the tube used and the values for various tubes are given in that part of this article which deals with the circuit and its characteristics.) 1 Belden Standard Color, five wire, cable. 2 Benjamin No. 8629 brackets, 2 to 6 Eby binding posts. 2 dozen

6 or 8-32 round head, brass machine screws, ¾ inch long. About 6 two-foot lengths of bus bar.

THE CIRCUIT AND ITS CHARACTERISTICS

IN DESIGNING this receiver we have attempted to keep in mind the difficulties encountered by some of our readers, who sometimes find that their local dealer does not carry a stock of a particular item, for use in a receiver, whatever kind it may be, and for this reason have endeavored to indicate what we believe to be intelligent substitution and variation in design to accommodate units of different size without materially altering the performance of the circuit. By referring to the circuit diagram and the illustrations of the models we have made, you will be able to see how the various units may be made to fit in whatever space you have available and how they will conform to whatever type of construction you may prefer. If we go over the entire circuit and consider each unit individually, this may be a little more comprehensive. So we may as well start with the antenna coupler.

There are now many sets of coils on the market, designed for use in the now famous series of Knockout Receivers, which have been described in RADIO BROADCAST. Any of these coils may be used in the "Aristocrat".

The tuning condensers used do not by any means have to be those we have chosen to use. Any good pair of .0005 mfd. variables will do, but what we wanted was single control, and in the "Aristocrat" we have it in a very practical manner. The only remaining requisites are the ballast resistors and the units which comprise the resistance-coupled amplifier system.

Let us consider the ballast resistors first. They are shown in the diagram as, R 1-2-3-4-5. Now the selection of these resistors will depend entirely upon the types

of tubes used and we have found what we consider an ideal combination in two of the standard storage battery tubes for the radio-frequency amplifier and the detector with two high-Mu tubes in the first two stages of the resistance-coupled amplifier and a semi-power tube in the last stage of the amplifier. Some tubes, such as the Daven MU-20, and MU-6; the Western Electric 216-A and the new Radiotron UX-210 will operate directly from a 6-volt storage battery without requiring any resistance in the filament circuit. Where tubes of this character are employed the ballast resistors and their mountings may be left out of the circuit entirely, or a direct connection may be made across the mounting, as shown in Fig. 2. In this receiver a ballast of ½ ampere capacity has been used with a Harvey Hubbell toggle switch connected directly across it. This makes it possible to use either 5- or 6-volt output tubes and either is thus assured the proper filament voltage. Most other high-Mu tubes are designed for use on 5 volts and where they are employed a ¼-ampere ballast should be used with each, or a single ballast of ½ or ¾-ampere rating may be used with two or three of them, in multiple.

That should clear up the resistance question, though it may be well to say in passing that filament rheostats may be used if they are on hand, and for extremely sensitive operation it will be found that a rheostat in the filament circuit of the radio-frequency amplifier tube provides greater flexibility than the ballast resistor method.

THE RESISTANCE-COUPLED AMPLIFIER

IN CHOOSING the system of construction for our principal model we have had in mind the idea that a certain balance may well be obtained between first cost and simplicity of assembly. For the inveterate experimenter we recommend the model

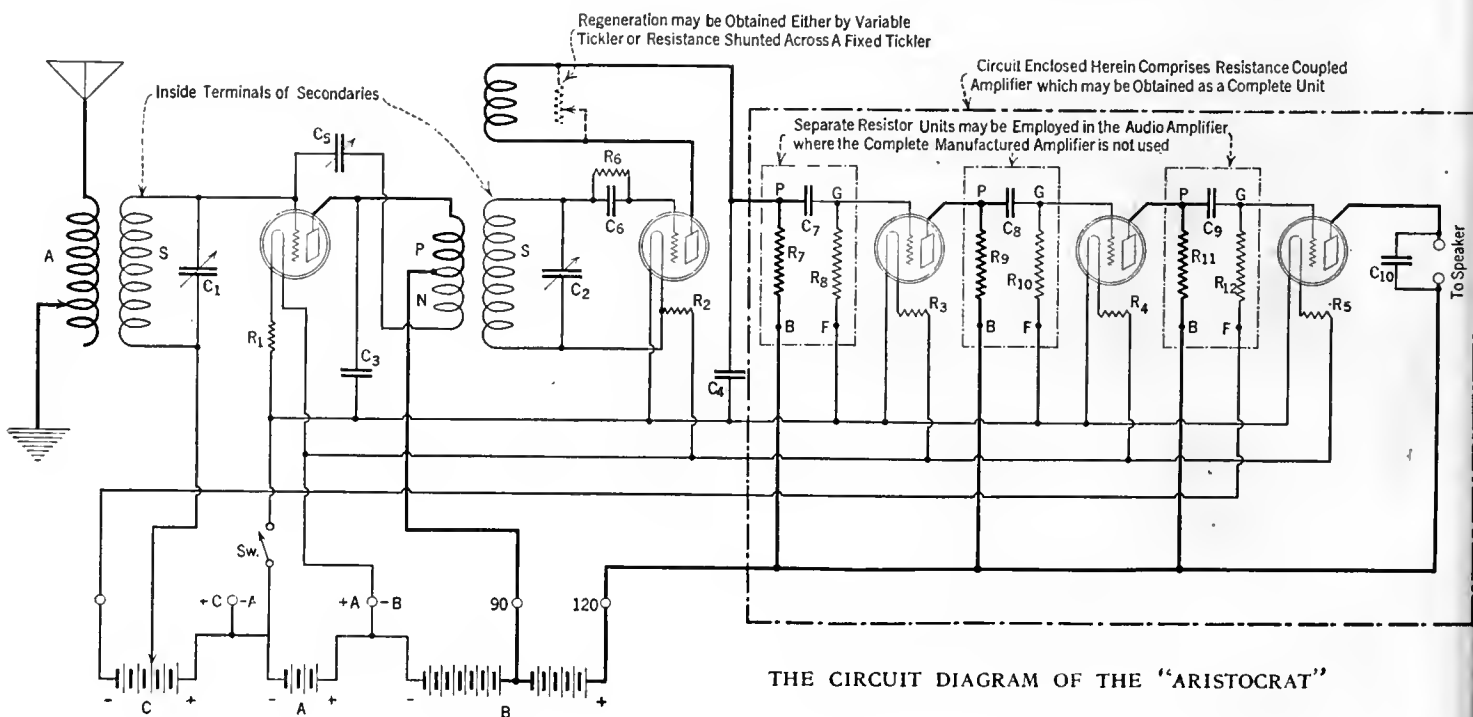

THE CIRCUIT DIAGRAM OF THE "ARISTOCRAT"

shown in Fig. 2. In a layout of this kind there is all the room necessary for experimenting with various units designed for the same purpose. This arrangement is a delight for the experimenter. For the average individual we believe our principal model will be more in keeping with his requirements and desires, for it permits him to make about all the changes he could desire without requiring an undue amount of wiring, as much of that has been done for him. For the third type of home builder, who desires to have as much of the building of a receiver as possible done in the factory, we suggest the model in Fig. 3 where a complete three-stage resistance-coupled amplifier unit has been shown.

One of the principal things to remember in connection with the building of a receiver in which a resistance-coupled amplifier is used is that it depends for its operation to a great extent on the actual resistance of the units employed. If, for instance, in one of the plate circuits where we have specified a resistance of .1 megohm (100,000 ohms) you use a mounting made of some material which in damp weather will absorb moisture, a measurement of the resistance in such a plate circuit will indicate that there is less resistance in the mounting itself than in the resistor used in it. There are many such devices being peddled about and you will do well to be certain that the units you procure do not suffer from such a defect. In other types of mountings which have been submitted to our laboratory for test we have found that the clips for holding the resistors are held to the insulating base by machine screws

and locknuts. Obviously, if the heads of the screws are not thoroughly countersunk and the mounting is placed on top of a condenser with a metal case, a short circuit is almost inevitable. Where you do your mounting on a wood base it is well to keep the wiring off the wood itself, as this will prevent leaks occurring in unexpected and undesired places. Some cheap condensers have been found to have a very low resistance in damp weather.

Another thing about resistance-coupled amplification, which has not been given the attention it deserves, is the size of the coupling condensers. We have found that they should be much larger, for the best tone quality, than is ordinarily suggested. The mathematical and experimental background for this assertion is sound. Do not use condensers in your coupling units of less than .1 mfd. if you want to procure better than average quality.

When you have finished building this receiver and you want to make an actual test of its quality, in comparison with other receivers, connect first one and then the other to a Western Electric cone speaker. If the receiver is right, the cone can be worked with tremendous volume with-

out rattling. The rattle, as a rule, is not an inherent fault in the cone; it is the result of imperfect amplification. In using a Western Electric cone, it should be remembered that the impedance of the cone is much lower than most other speakers and the output tube used with it should be one with a plate impedance that matches the cone, such as the new semi-power tubes to which we have previously referred. If an ordinary tube is used with the cone, an output transformer should be used which will make up for the unbalanced condition that would otherwise result.

If you consider the little things in connection with the building of RADIO BROADCAST'S "Aristocrat" you will produce a receiver which you will be proud to exhibit to your friends. You will enjoy radio as it is but very seldom heard.

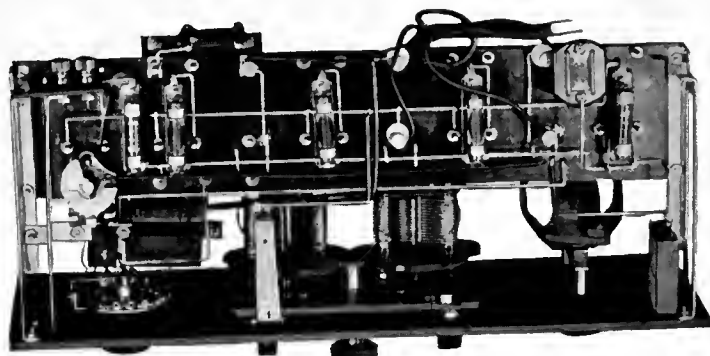

RADIO BROADCAST Photograph

FIG. 7

Bottom view of the "Aristocrat". Illustrating the wiring under the sub-panel. The only units not shown in Fig. 6 are the two Eby posts on the extreme left, for antenna and ground, the Amperite and Daven ballast for the filament circuit of each tube and the Belden battery cable

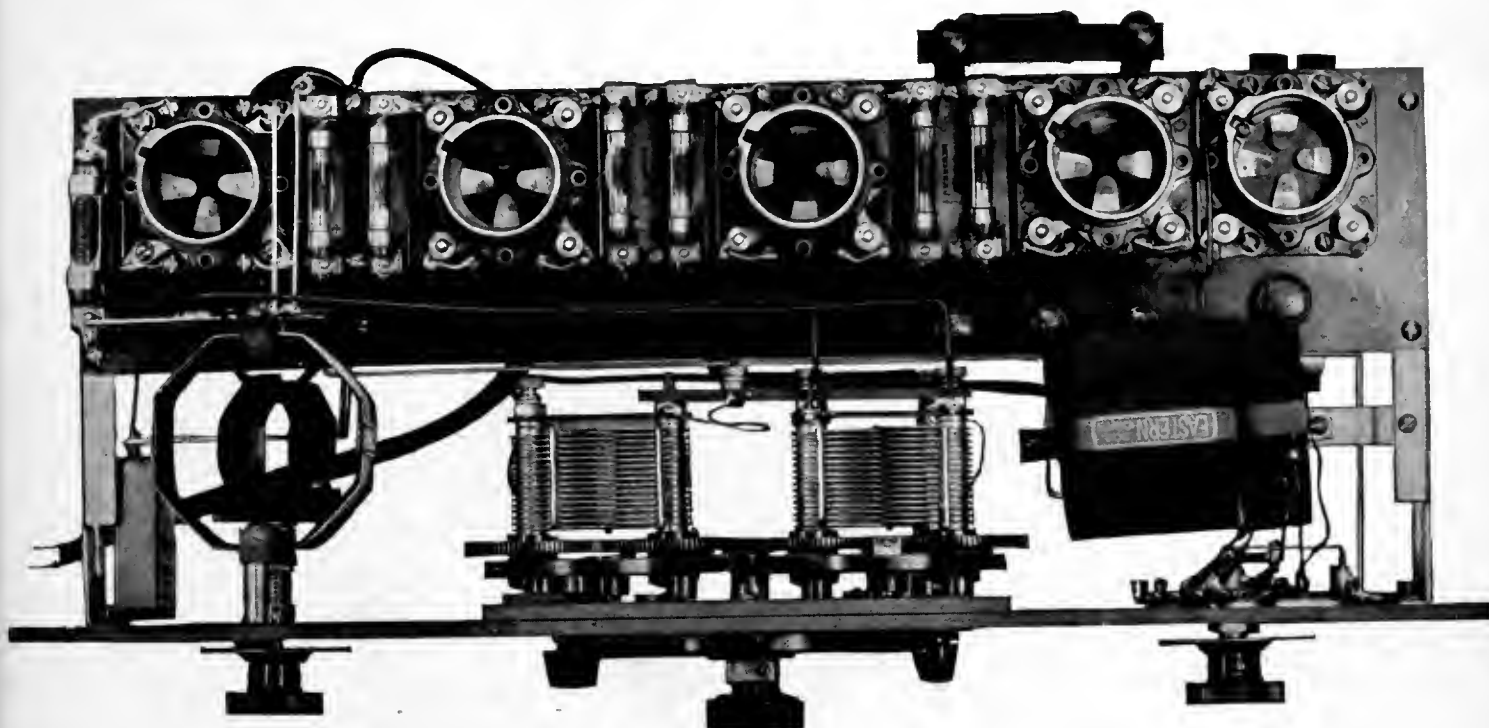

RADIO BROADCAST Photograph

FIG. 6

The "Aristocrat." Left to right on the sub-panel we have the Daven leakandenser, Benjamin socket, Sangamo .004 bypass condenser, Daven resisto-coupler with .1 and 1 meg. resistors, socket, resisto-coupler with .1 and ½ meg resistors, socket, resisto-coupler with .1 and .25 meg resistors, socket. The .1 microfarad condensers are within the resisto-couplers. The two Eby posts on the upper strip are for the loud speaker. The three posts on the lower side are for the C battery and the small knob is for the Hammarlund variable neutralizing condenser. Left to right on the main panel are the Benjamin bracket, Dubilier .5 by pass condenser, Eastern Knockout r. f. coupler with Apex knob, Hanscom single control unit with Marco dial, Yaxley filament switch, Eastern Knockout antenna coupler with Carter antenna switch and another bracket

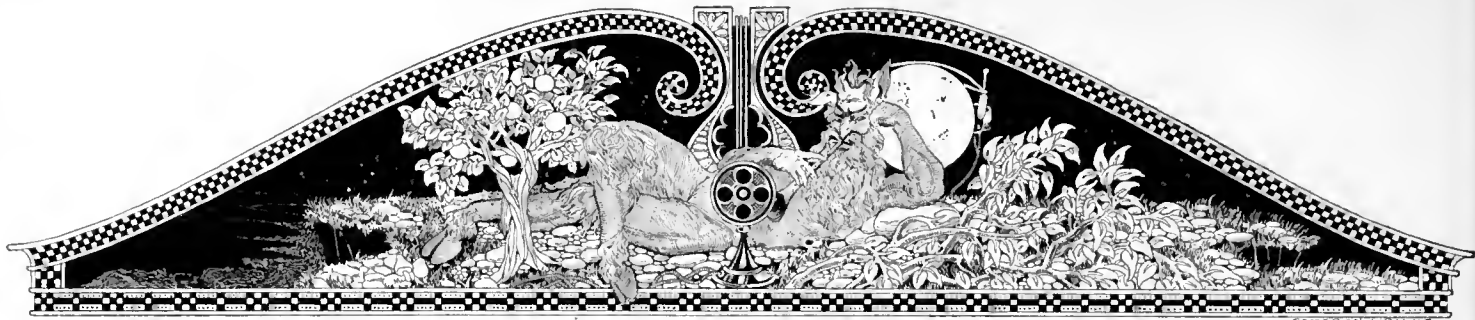

# The Listeners' Point of View

Conducted by Kingsley Welles

## Who Are the Owners of Our Radio Sets?

**W**HEN the broadcast announcers tell you over the air that two million people are hearing the "program now being broadcast," it is breaking no confidences to say that they do not really know how many listeners they are actually reaching. Almost everyone who has had the opportunity has played fast and free with statistics dealing with radio, particularly the number of radio receivers and their owners. There is no positive way to tell just how many sets are in use. The question, "Have you a radio set?" might well be added to the already long list asked by the United States Census, although we should have to wait until 1930 before these now occult facts could be made public. It is an excellent maxim not to take any statistics too seriously, for like the Scriptures, the Devil can (and probably does) quote them for his own purposes.

But slices of the radio listening group have been visited by the equivalent of the Inquiring Reporter, and the results, while they prove nothing but facts about the given group, are interesting. The figures give one a pretty fair idea of what sort of an individual the composite radio listener is.

Two thirds of those interviewed owned receivers and nearly 72 per cent. were men. Ages varied from under 20 to the ripe age of 71. The group between 21 and 30 years old were most attached to radio. Men were more anxious to have a set installed than women, for more than 58 per cent. of those approached in the survey were men and responsible for the purchase of the equipment. Wives came second with a percentage of 22, while the clamor of the children in 20 per cent. of the total succeeded in securing the set.

Out of 1200 homes investigated in one survey, 66 per cent. were operating their first sets. The remaining third had owned radio equipment previously. Some families had owned as many as nine outfits; in fact, this group represented 5 per cent. of those interrogated. And 45

per cent. were using their second receiver, while 21 per cent. had purchased three. One home confessed to having six sets on hand; five others had five receivers apiece, and 110 households had two or more.

The investigators were much interested in learning why a particular make of receiver was bought. It was found that 46 per cent. of the owners purchased their set because they thought it the best make, while 17 per cent. acted on the advice of friends, and a lagging 12 per cent. bought because of low prices. Some were influenced by advertisements, but almost as many were convinced by a personal demonstration in their homes.

Radio receivers appear to be regarded by these groups as a necessity rather than a mere convenience, as some of the unconvinced seem to think. Out of 1166 set owners asked the price paid for their equipment, 24 per cent. did not know what it cost, although 12 per cent. bought be-

cause the cost was low. The initial cost of the sets varied from \$2 to \$650. The average cost of the receiver was \$100. The manufactured set cost more than the home-assembled receiver, which was found to cost about \$40. The survey indicated quite definitely that most of the present owners are willing and expect to pay more for their next set. Some 40 per cent. expect to pay between \$150 and \$200 for their new receiver.

Out of 1280 homes investigated in one census, nearly 36 per cent. had five-tube sets in operation, 9 per cent. used more than five tubes, and 19 per cent. used receivers with three tubes. Crystal and one-tube receivers accounted for 8 per cent. each. In England, by far the greatest number of listeners use crystal receivers, which are naturally not at all selective and their range is limited to about five or ten miles. One of these American surveys showed that 47 per cent. of the owners bought their sets in order to receive programs from distant stations. Selectivity was considered the most important factor by 42 per cent.

In Seattle, whose population by the last census is given as 237,000, a kind of radio census was taken, which showed that 18,000 radio receivers were in use in that area. Three years ago, the crystal set was very much in the majority in that city, as it was in almost every other. Now only 21 per cent. of the Seattle listeners use crystal receivers. Thirty-seven per cent. of the sets are single-tube ones—usually home made. Forty-eight per cent. of the tube receiving sets are either five- or six-tube affairs. Seattle is probably reasonably representative of the country, although it is highly doubtful that 21 per cent. of the outfits of the nation are crystal receivers.

Probably the most interesting part of the surveys is found in the answers to the question, "Who runs the set?" In 455 cases out of 644 it was the man of the house—71 per cent. Women did the tuning in 6 per cent. of the total and the children in 3 per cent.



THE FIRST OPERATIC BROADCASTER—1908  
Mme. Mariette Mazarin, operatic soprano under the management of Oscar Hammerstein, who came to New York to create the rôle of "Elektra," shown in an old photograph singing in the microphone of an early DeForest arc radio telephone transmitter. A few earnest experimenters heard Mme. Mazarin then, but what an audience she would have to-day!

What Hope for Programs?

The response of the radio audiences to the concerts of the New York Philharmonic Orchestra is very significant. It is not improbable that several hundred thousand persons listened to these concerts over the air during the summer. That their appreciation is keen may be judged from the fact that wjz and wgy—fully alive to the public's wishes—have seen fit to give the concerts such prominence on their schedules. This in itself is encouraging. Even more so is the interest of the public in the best class of music. Broadcasting stations reported a year ago that there was a notable increase in the number of letters asking for more concert music. . . . The experience in this broadcasting shows that there is a much larger audience of music lovers in this country than was thought to exist. . . . What the Philharmonic has done, others can do. What we have lacked (in this country), save in the big cities, is the opportunity to hear good things. This the radio now gives us.—Editorial in the New York Times.

**B**Y FAR the outstanding event of the summer radio season was the broadcasting of the Philharmonic Orchestra at the Lewisohn Stadium in New York. Aside from the fact that this broadcasting was technically the finest bit of broadcasting we have ever heard, the Philharmonic programs were noteworthy because of the high musical standard of the selections and their rendering. One hour of a Philharmonic concert is worth, by actual calculation, 2027 hours of any jazz band you can mention.

There are mutterings against jazz, and they are none too faint. We venture the prediction that the stations who want to stay in the van will have to rearrange their schedules so that jazz takes a secondary place on their programs—if for no better reason than variety. Who would attend a vaudeville performance where 50 per cent. of the program was devoted to dance music?

The wire links of WEAf to the outlands will furnish much excellent program material. The recent announcement by A. A. Kent that Metropolitan Opera stars have signed for a series of concerts, to be broadcast through WEAf and a chain of Middle Western stations beginning October 4, is the first good omen in the Fall Season. The WEAf Grand Opera Company will furnish tabloid grand opera to a large group of stations. We have heard many listeners say, and not a few have written us, that they think this feature one of the best to be found in the air lanes. There is now a pleasing tendency among program directors to arrange radio speeches which have some justification for their being. Program directors will never learn, however, that there is no possible justification for broadcasting an entire banquet. It is bad enough to be forced to attend a banquet, but when one has to listen to the rumble of moving dishes, the distorted sounds of an orchestra perhaps, and the hollow echoes of "speeches of the evening" which reverberate in the banquet hall despite the best efforts of the microphone to ensnare them—then the limit of something has been reached.

But in the main, the start of the fifth year of radio broadcasting is good. In a hundred little ways programs are being improved and more able individuals are coming to the studios, in the persons of both performer and director.

Church Broadcasting: A Failure

**I** THOUGHT, as a matter of course," writes Charles Magee Adams, of Milford, Ohio, "that a considerable majority of my neighbors picked up church

services regularly. They tune-in every other radio offering, and religion, regardless of creed, is something whose appeal is universal and fundamental. But I find that, on the contrary, the overwhelming majority of my neighbors' sets either stand idle during church hours or pick up a program of some other type if one is within range. They began listening zealously enough when the sets were new, these friends of mine (and I am sure they are representative of the radio audience), but gradually discontinued the practise, for reasons hinted at rather than explained. There were vague remarks, such as 'I don't care much about it.' From this and similar remarks and my own convictions, I came to the conclusion that something is wrong with church broadcasting."

In the September "Listeners' Point of View," issue was taken with the arrangement of Sunday programs in general and it was mentioned that broadcasting from churches is not very successful. Mr. Adams develops the point. "The Church thinks of broadcasting," he continues, "simply as a means of bringing its services to shut-ins and as a sample to interest prospects; in other words, broadcasting is an auxiliary to and substitute for attendance at services in person. This is not to say that these aims are not legitimate and laudable. Bringing help and comfort to dwellers in remote places or to invalids is a fine service; and attracting more people into church membership is altogether worth while.

Radio has placed at the disposal of the church an instrumentality for multiplying its usefulness to an extent that leaves possibilities difficult to grasp. Yet the church classifies radio as an auxiliary, a substitute; and continues to place the emphasis on assembling in congregations.



FLORENCE LONG ARNOLDI

Coloratura soprano, a regular artist at station WOAW, Omaha. Her voice has thrilled and delighted many an evening's radio audience. One might add that her costume is fully as charming as her voice



GOLDY AND DUSTY

Sometimes referred to as the Gold Dust Twins, who are heard every week from WEAf and a chain of stations, in an "indirect advertising" program. It is darkly hinted that they are two well-known concert singers, well known to buyers of phonograph records, who have turned their talents to broadcasting



MISS JEAN SARGENT

Who was for four years with WNAC, Boston, and now is in charge of women's programs at WHT, Chicago. Miss Sargent is said to be the first woman announcer. Her voice is frequently heard over WHT



"LOPEZ SPEAKING"

This concert, by Vincent Lopez and his orchestra, is being broadcast through the courtesy of station W-E-A-F direct from the Pennsylvania Hotel Grill. The next number . . . On the Radio"

This is much the same as if, during the last presidential inauguration, the nation-wide radio audience had been told that it might listen-in at home, but that attending the ceremonies in person was vastly to be preferred.

Mr. Adams goes on to enumerate the disadvantages of this widespread attempt to adapt the service designed for attendance in person to the special requirements of broadcasting. "The acoustics of church auditoriums result in cavernous boomings and reverberations . . . and it is impossible for the preacher to adapt his delivery both to the radio audience and to his congregation. Much the same is true of the incidental music. Announcements of interest only to the congregation must be made from time to time. These strike the listener as wholly irrelevant and are psychologically very important.

"The Church should arrange a special service, with universal appeal, conducted in a broadcasting studio according to the



KEITH MCLEOD

Accompanist and musical director of stations WJZ and WJY, New York. He accompanies Mr. Godfrey Ludlow in the popular Sunday night recitals from WJZ and is a pianist of great talent. Mr. McLeod is a Westerner, coming from Denver, Colorado

best radio practise. Sermons should be cut to somewhere near ten minutes—the length of maximum radio listener attention. (The closing speeches broadcast in the last presidential campaign by President Coolidge and Mr. Davis—the most effective radio addresses delivered by either—were 11 and 13 minutes long.) Radio has placed before the Church an opportunity for usefulness greater than any other single one in all its long history. The Church has failed so far to make the most of this opportunity, not because technical facilities are undeveloped, but because the Church has not chosen to adapt itself to this new potentiality." With all of which, needless to say, we heartily agree.

### Do Women Know What They Want In Radio Programs?

**I**N ENGLAND recently, a woman graduate of Cambridge debated before the microphone with a woman who had been in charge of various canteens during the war on what subjects appeal most to women listeners. The Cambridge graduate favored amusing and intellectual talks of a non-domestic character, and the ex-canteen manager declared she wanted talks on practical subjects and "ultra-feminine topics"—whatever they are. Listeners were asked to express their views, and some 80 per cent. of the letters sided with the Cambridge woman. Cookery, child welfare, and household management talks were not wanted. The general cry was: "Take us out of the kitchen and take us out of ourselves!" The letter writers wanted talks on music, literature, travel, women's movements, etc., with an occasional fashion talk or humorous reading.

Almost without exception American broadcasting stations, when they have a program for women, have limited it to the obvious domestic things. No broadcaster has had the courage or the intelligence to arrange a program to appeal to the intelligence of women. One wonders whether this failure is due to a belief that it would be useless to make the attempt or because the program designers simply fail to appreciate the necessity.

However, a new feature for women has been started by the Washburn Crosby Company with the talks by Betty Crocker, on Monday, Wednesday, and Friday mornings through WEEL, Boston; WEAJ, New York; WFI, Philadelphia; WCAE, Pittsburgh; WGR, Buffalo; WEAR, Cleveland; WWJ, Detroit; WHT, Chicago; KSD, St. Louis; WDAF, Kansas City; KFT, Los Angeles; and WCCO, St. Paul-Minneapolis. This is a genuine forward step in broadcasting, for it is the first time a national wire link has been employed for a program of "service." It is frankly commercial broadcasting, and that of the most defensible sort. Perhaps this national effort will awaken the program directors, and they will now busy themselves and arrange women's programs of broader appeal.



"ERNIE SPEAKING"

I want to thank all my radio friends for the wonderful letters they have sent me. I will be pleased to send a log book with a picture of my orchestra on it to everybody writing for one. The next number played by Ernie Golden and his Hotel McAlpin Orchestra will be 'The Farmer Took Another Load Away'"

### The Shy Radio Minstrel

"A wandering minstrel I,  
A thing of rags and patches. . . ."

**M**INSTRELS have quite gone out of fashion except as one reads of them in good old classical ballads, or hears the lines quoted above floated out at one during a "Mikado" performance. The fact is that the automobile—and we almost said radio—has made the minstrel business a bit superfluous, and probably unprofitable. To come out with a startling truth, radio broadcasting has brought the minstrel back again. Most of our modern minstrels travel on the best trains instead of a slow and probably underfed horse and are well paid for their time, as witness the favorite Wendell Hall—in the employ of the National Carbon Company, who only last



GODFREY LUDLOW

Staff violinist at station WJZ getting his fine Stradivarius—the de Rougement, dated 1703—ready for a recital. Mr. Ludlow is an artist of high ability, and through his Sunday night concerts through WJZ and WGY has won a very large following

year shadowed the microphone of most of the important broadcasters of the country. He sent this department, we recall, a postal card from Cuba while he was on his lyrical mission there.

There are a host of others who travel about, some who are paid for their services and others—a majority of the number, in all probability—who give their services to the broadcasters for the pure love of the thing, which, being translated, means for the "publicity value." The management of station KGO admits that within the past thirty days five radio minstrels reported to the studio manager, ready to do their bit "entertaining the silent audience of the day and night." One was armed with a harmonica, another played a Tyrolean zither, another carried a set of "sweet potatoes," while a fourth drove to the station in a Ford and unloaded his "kitchen piano" or dulcimer, which is stringed, and as a WEAFF announcer phrased it the other night, is "the grandfather of the piano."

"We are only observing the old Biblical injunction," admitted one of the minstrels. "We cast our music on the air, and, brother, it works! As I travel, I meet friends everywhere—and chicken dinners, too."

The electrical *wanderlust* has spread to broadcast announcers, too, for we have heard from a number of stations during the lately concluded summer, elaborate and flowery introduction of this well-known announcer, and that being presented over a rival but friendly microphone.

### Broadcast Miscellany

WHEN broadcasters close their program, it is usual for them to announce the time. "Station xxx now signing off at 10:10 P. M., Central Standard Time. . . ." We took the trouble to check the announced time from a number of stations recently, and the variations from the actual minute were fearful to behold. It is a small matter, but if the broadcaster really means what he so often says about "service" we suggest he take care his clocks are right. We will wager that a good many trains are missed because of carelessness of this sort.

THE bubbling Ernie Golden, radio good fellow par excellence, announced from WMCA, New York, the other night that a certain performer would "now whistle 'To a Wild Rose.'" A curious occupation for a grown man, but perhaps less futile than the not uncommon announcement of this or that hopeful "broadcasting to listening relatives in Brest-Litovsk."

THE next number will be played by request." Similarly worded confidences are whispered into many a defenseless microphone, the good Marconi

only knows how many times each evening. This gracious compliance with wishes never fails to remind us of that ultra-complier, Josephus, whose fame is sung in a good old ballad:

Now these two boys are dead and gone.  
Long may their ashes rest.  
Bohunkus of the cholera died,  
Josephus, by request.

IT IS the common practise among wire and radio telegraphers to use their initials or some other cabalistic set of letters to indicate their presence at the station, chiefly because it takes too much time to send with each message, "sent by operator Charles B. Smith," or the equivalent. When the radio operators became radio announcers, as many did in the early days of broadcasting, before the present age of specialization where every station with any claim to pretension has its staff of announcers, its program and publicity force, and its group of operators—they took with them the practise of giving their initials during the announcing. The original purpose of the abbreviation was to save time, but now there is no possible justification for the practise. The announcer is—if he is even moderately talented—an asset to his station, and in many ways he is as important as the event or the artist he introduces. Why, then, should he not give his name? The practise was begun by WEAFF. Millions, probably, heard the name of Graham McNamee, and were charmed by his easy grace and high talent for description. But some power above gave his orders and now no longer do the Bell System announcers reveal their identity. The Radio Corporation group do,

however, and if you don't believe that the name of the announcer adds a necessary touch to the broadcast proceedings, compare some night the offerings of a station representing each group. When the listener knows the name of the announcer serving him, an indefinable something is added which is highly desirable. It makes for better announcing, too; Milton Cross of WJZ probably felt a greater responsibility and approached the task of preparing those extraordinarily able program notes he gave for the New York Philharmonic Concerts (given through WGY, WJZ, and WRC) with considerably more enthusiasm since he knew that large numbers of listeners-in looked to him for his interpretations. And, *contra*, the WEAFF announcer who handles the Hotel Bossert orchestra several nights a week might make more certain that what he says by way of "fill in" is really funny, if his name were aërially signed to his remarks.

THE late Walter Camp and his system for the glorification of the American physique, known familiarly as the "Daily Dozen" is probably responsible for the radio popularity of the setting-up exercises. Aided by a bugle, and the less military piano, unseen physical training instructors dispense musically accompanied instructions for health exercises from a great many stations. Though there is no sure way of estimating, the number of exercises must be very large. We hope that this new addition to the radio program may become such a fixture that it entirely displaces the bedtime story—misguided juvenile sentimentalism which everyone, including the children, could well do without.



IN THE VILLAGE OF JUAN DIAZ, PANAMA

The natives hear a program from a Cuban broadcasting station. The radio receiver is part of the "on location" equipment of the company filming the picture "Spaces Beyond" in Panama. It is a question whether the natives living on the calm little Tapia River in the background were more impressed with the radio concerts or the strange behavior of the cameramen and directors

# A Model 1926 Broadcast Receiver

Designed to Meet Present Requirements of Great Selectivity on All Frequency Bands, This Set Is Highly Satisfactory in Operation and Decidedly Easy to Build

By McMURDO SILVER

FOR some time past, the writer has felt that it should be possible to design a radio receiver possessing all of the valuable features of the best super-heterodynes, yet going a step beyond in dealing with the coming seasons' radio problems in a manner not possible with any previous systems, since none of the present aggravated reception conditions were even imagined during the past year.

Before examining this system in detail, it may be interesting to consider a few of the facts concerning present, and probably future, broadcasting conditions, which, incidentally, will explain in a measure the writer's apparent abandonment of the super-heterodyne school of thought. In a nutshell, a simpler system has been so improved that it is now nearly the equal of the super-heterodyne.

## BROADCASTING CONDITIONS—TO-DAY AND YESTERDAY

LAST year at this time, the entire range of available broadcasting channels may have been occupied by transmitting stations, but any listener of a year's standing knows that in actual operation this was not so. Channels could often be found where stations were not transmitting, and it was seldom indeed that a fan could pick up the full quota of approximately 95 stations that would be required to fill properly the broadcast frequency range of 1500-550 kc. (200 to 546 meters), a range of some 950 kc. Obviously, there will be far more stations operating simultaneously than there were last year. Equally obviously, we require far more selective receivers this year than last.

To-day the range of the broadcast frequency is from 1500 to 550 kc. (200-546 meters). Re-broadcasting goes up to 5996 kc. (50 meters) in some cases, and it is quite possible that the regular broadcasting range may be extended above 1500 kc. (200 meters). Foreign super-power broadcasting takes place in many instances on long waves, running up to several thousand meters. Of what value, then, is last year's receiver, with its satisfactory operating range generally from 1330 to 520 kc. (225 to 575 meters)? This year, and future years, sets must be capable of covering a wide wavelength range—far wider than any existing designs will cover.

## A RECEIVER TO MEET PRESENT CONDITIONS

IT IS felt that the receiver to be described adequately solves the problems encountered, with fewer tubes and less equipment than a super-heterodyne, yet is capable of equalling super-heterodyne selectivity and sensitivity—a goal indeed worth aiming at. The re-

ceiver itself is shown in the accompanying illustrations, which bring out the mechanical details of panel design, instrument arrangement, and wiring.

At first glance, the set does not seem at all original, since it consists merely of two stages of tuned radio frequency amplification, followed by a detector tube and two audio amplifiers. The circuit is a combination of the best points of all receivers, carefully executed with regard for the most recent discoveries, and the fund of information gained by the writer and his assistants through contact with many thousands of experimenters—men whose judgment of receiving equipment was based solely upon one thing, performance.

Since one of the first requirements was wavelength flexibility, it was necessary to devise a method of shifting inductances for different frequency bands. This made necessary the designing of interchangeable coil forms possessing a form factor suitable for all frequencies to be handled. For the higher frequency bands, the turns are spaced, while the coils for waves longer than the present broadcast band, the coils may be bank wound. Six contacts are provided on a reinforced ring at the bottom of each coil, upon which are mounted six studs in which the ends of the windings terminate, and which in turn make contact with springs in a special six-contact socket, so keyed that a coil cannot be inserted incorrectly. In order to change a frequency band, it is necessary only to remove the coils from their sockets and insert ones of different inductance values—an operation consuming about 10 seconds.

## STRAIGHT LINE FREQUENCY CONDENSERS

THE condensers used with these inductances are of the type giving an approximately straight line frequency variation, or a uniform kilocycle variation for each dial division.

A very important factor for broadcast reception, particularly on short waves, is the ratio of inductance to capacity in a tuning circuit. The 500 mmf. (.0005 mfd.) condensers, which are commonly used, prove rather large for use above 1500 kc. (200 meters). Even above this, the inductance capacity ratio resulting from their use is not as good as with 350 mmf. (.00035 mfd.) condensers. In order that maximum signal strength may be obtained, the condenser capacity should be kept as low as possible. For another reason, this is of vital importance at short waves where tuning is practically impossible with large condensers. Above 6000 kc. (below 50 meters) tuning capacities should be on the order of 150 mmf. (.00015 mfd.) although below this, 350 mmf. seems quite satisfactory.

Neutralization, which is nothing more than fixed oscillation or regeneration control, could not be used. This is because the r. f. amplifier for a given frequency band, would have to be neutralized at the shortest wave to be received in that band so that the amplifier would not oscillate. Sensitivity would be obtained then only at the lower end of the wavelength band, while the receiver would be as inefficient and as little sensitive as the average neutrodyne at the longer waves. In this connection, the now popular circuits employing a stage of tuned neutralized r. f. amplification and a regenerative detector were considered. In them, due to reaction, regeneration in the detector circuit tends to assist the neutralized r. f. amplifier. This being at best an indirect solution of the problem, the r. f. amplifier in this design was made highly regenerative, with an increase in sensitivity, since a much stronger signal could then be delivered to the detector tube, the efficiency of which varies with the square of the applied voltage. This means that, with a given signal applied to the detector, doubling the strength of the signal will increase the detector response four times. In the new receiver, due to reaction, the detector circuit is rendered practically as sensitive as if direct regeneration were employed (see the writer's article in the March, 1925, issue of RADIO BROADCAST) through the reactive effect of regeneration in the r. f. amplifier.

## NEW REGENERATION CONTROL

THE actual method of regeneration control employed is new, practically, and consists of a variable high resistance in shunt with the grid circuit of the

---

NOW and again, readers of RADIO BROADCAST have asked us why we did not publish more information on the familiar five-tube, tuned radio frequency receiver. Our position was that as soon as we found a receiver sufficiently good and sufficiently off the beaten path, a description would find its way into the pages of the magazine. RADIO BROADCAST has published many articles on the neutrodyne (December, 1923, January, and February, 1924, and August, 1924), and many more on applications of tuned radio frequency circuits. The receiver here described involves no "revolutionary circuit," but it contains other features which are certain to be of positive interest to the constructor. These departures in design are used which give ease of control, adjustment to various frequencies, and well-nigh perfect selectivity:

- 1 Plug-in coils for covering all broadcast frequencies.
- 2 Straight line frequency condensers, insuring even spacing of received frequencies along the dial. The exact dial location of a given station can be precalculated after referring to published programs.
- 3 Proper detector grid biasing instead of the conventional grid leak and condenser.
- 4 A new system of regeneration control achieved by shunting the r. f. secondary coil with a variable 500,000-ohm resistance.

This excellent article is another of the special features promised our readers in the new RADIO BROADCAST, and we think it well justifies its place.—THE EDITOR.

---





FIG. 1

Front panel view of the five-tube receiver described in this article. The three tuning dials may be linked together as one if desired. The plug-in coils are shown at the right

second r. f. tube. Customarily, a grid biasing potentiometer is employed which is extremely inefficient at short waves although satisfactory at long waves as in a super-heterodyne, or a series B battery resistance. The latter, the most popular method, is extremely unsatisfactory, as it merely controls oscillation by reducing the effective amplifier plate voltage. This process is bound to detune the set in a measure, as well as throw the amplifier tubes entirely off their proper operating characteristic if a C battery is employed, as should be done. In the system used, a variable resistance of 500,000 ohms is shunted across one tuned circuit feeding into the tube's grid circuit. The probable average operating resistance of the tube is about 150,000 ohms, so that the resistance is so far in excess of this that selectivity is not affected. Due to careful design of the circuit, it is only necessary to decrease the value of shunt resistance to not less than 300,000 ohms to get excellent oscillation control. Obviously, this method will not affect selectivity to the detrimental extent that any other method would.

Due to the extremely low losses of the three tuned circuits, the overall amplification curve resembles that of a band-pass filter, such as is used in carrier telephone work; in some cases for separation of carriers—not 10 kc. apart as in radio—but only 3 kc. apart. This is the ideal response curve and can only be obtained by other systems after they have gone beyond the limits of practicability; or practically by the super-

heterodyne. The next most satisfactory curve would probably result from the single r. f. amplifier and regenerative detector mentioned above.

The efficiency of the receiver decreases rapidly at frequencies greater than 2000 kc. (150 meters), so that at 6000 kc. (50 meters) it will probably only work slightly better than a regenerative detector and the same number of audio stages. This is true of all r. f. amplifiers, but it must be remembered that it is practically impossible to improve upon a regenerative detector at short waves. This is not because more sensitive systems cannot be built; rather, that they are not required—transmission efficiency renders the use of a terrifically sensitive receiver unnecessary.

#### AUDIO AMPLIFICATION

THE audio amplifier shown uses two standard  $3\frac{1}{2}:1$  transformers, and will be found to give most excellent reproduction. However, resistance coupling may be used where practically perfect quality is desired. Unless high-Mu tubes are used in the first two stages, and a low-impedance tube (such as UX 112, UX 120, UX 210 or the Daven), in the last stage, resistance coupling is not worth while. The only high-Mu tubes generally available for standard sockets are made by Daven. However, using ordinary tubes, choke-coupled amplification will about equal resistance coupling, using the new 350-henry Thordarson autoformers. Three stages will be required, with but 90 volts of B battery rather than 135, as with the resistance audio amplifier.

The current consumption of the receiver is astonishingly low. With six tubes, three in a resistance amplifier operating on 135 volts, it was but seven milliamperes as against the general 15 to 20 for neutrodynes and 15 to 30 for supers. Despite the fact that storage battery tubes were used throughout, this was made possible by biasing all grids  $4\frac{1}{2}$  volts negative. Thus, the amplifiers all have the correct bias for 90 volts, while the detector bias is correct for 45 volts. This practice, unusual in the case of the detector, results in an increase in overall efficiency due to lower detector input losses, plus the greater handling power for strong signals, unobtainable with the customary grid-condenser-leak method of obtaining rectification.

#### SINGLE, DOUBLE, OR TRIPLE CONTROL

THE receiver may be tuned either as a single, double, or triple control outfit at will. Each condenser is provided with a pulley collar on its shaft, which may be connected with all the others by means of fish-line. While at first this idea may seem impracticable, it is well to remember that the builder of one of the country's finest commercial receivers has used the method for years. This season it will be found on the Bosch, Grebe, and Zenith receivers, not to mention others. It is, to the writer's mind, the most practical single-control scheme yet devised, because of its flexibility. Thus, the builder of a set may test it out carefully, determine just how it logs, then put the fish-line in place and realize a

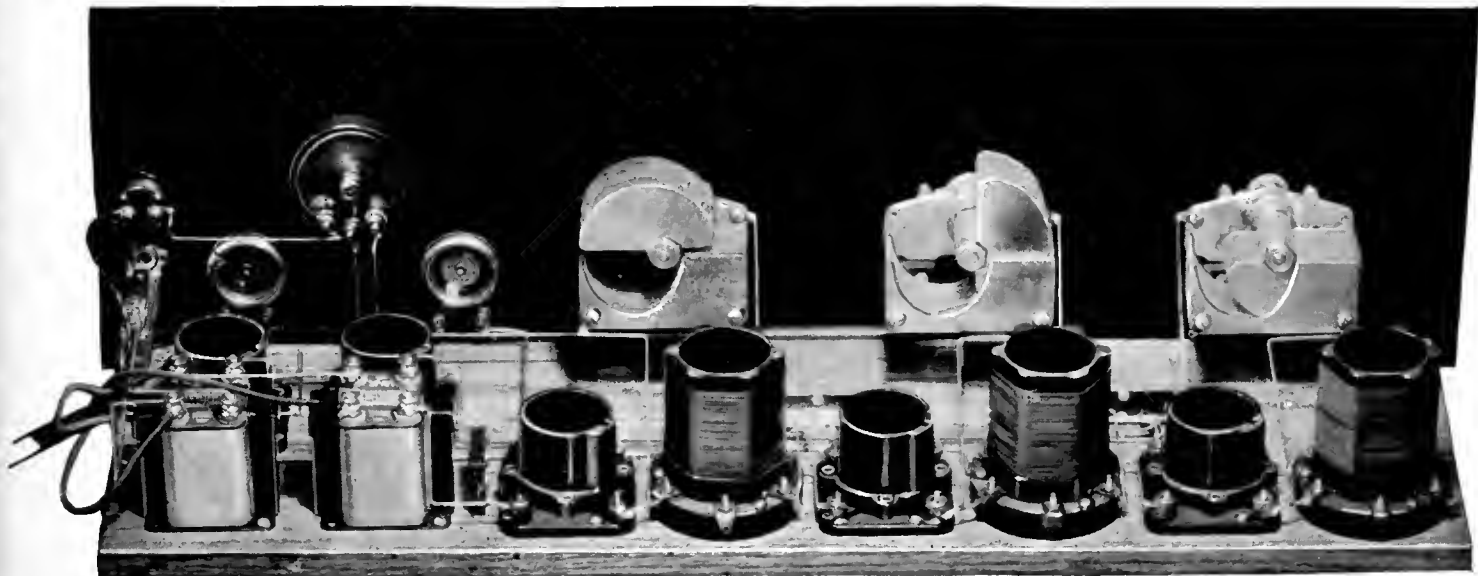
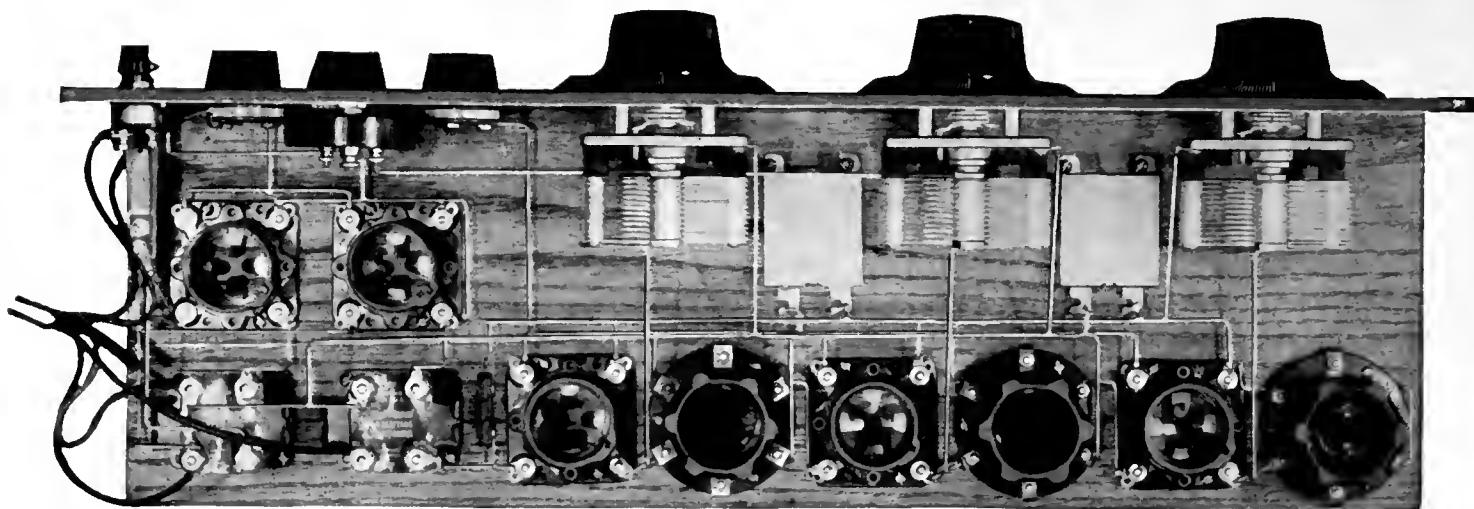

FIG. 2

The five-tube receiver from the rear. Note the three interchangeable coils and their sockets. The battery cord leading away from the left end carries all battery supply wiring

RADIO BROADCAST Photograph



RADIO BROADCAST Photograph

FIG. 3

This photograph should be studied carefully before laying out the baseboard, since no dimensions are given. This is because different types of instruments may be substituted, so the layout can only be approximately followed with respect to spacing of the parts

true uni-control set without the fear that all the circuits may not be properly adjusted, as in the case of gang condensers. The use of external compensating capacities, often suggested with gang condensers, is not particularly to be recommended.

Further, a multiple range, uni-control receiver cannot be built practically. It might be possible to build it for one frequency range, but if coils must be interchanged, the circuits must be compensated for errors that cannot be overcome. This is where the beauty of the fish-line control comes in—it is merely necessary in logging at first to determine how many degrees apart the three dials may run for one set of coils, then when they are used, adjust the dials to this relation and go ahead tuning with but one or two controls as desired, since holding one or two dials with the fingers and turning the other merely causes the fish-line to slip, only to grip tightly again when but one dial is turned alone. Yet the arrangement is totally without play or backlash.

#### TUBES AND RHEOSTATS

THE receiver illustrated uses two rheostats, one for both r. f. tubes and detector, and one for the a. f. tubes. This permits the use of small tubes up to the detector, and larger or power tubes from there on. It is suggested that UV-201A and UX-201A (identically the same except for bases) be used throughout, up to the last stage, where a UX-112 or a UV-210 for extreme volume be used. Dry battery tubes may be employed if desired, but UV-201A's will be found to give about 15 per cent. greater volume. Rheostats are not vitally necessary, with tubes coming through with their present uniformity. There is no reason at all why Davens ballast resistors or Amperites may not be used for permanent filament control.

#### FLEXIBILITY

ONE feature of the set is its flexibility. It may be used on antenna or loop with either only a detector, one r. f. or two r. f. amplifiers. Suppose an antenna is to be used, the antenna coil with its adjustable rotor for maximum selectivity is inserted in the socket at the left end of the set. Then the r. f. coils are put in their sockets and the antenna and ground connected to posts 1 and 2 of the antenna socket. Thus, we have detector and two r. f. stages. If only one r. f. stage is desired, the first tube is removed, the antenna coil moved to the middle socket with antenna and ground connected to 1 and 2 of this socket, and the set tuned with the two right-hand dials. To use only the detector, the antenna coil and antenna and ground leads

are moved to the socket nearest the detector, and all tuning is done with the right-hand condenser. If a loop is to be used, the antenna coil is removed, and the loop leads connected to 3 and 4 of the socket from which the coil is removed, depending upon the number of r. f. stages desired. The a. f. amplifier is controlled by jacks, one for the first and one for the second stage. Thus the set may be changed from a two to a five tube set at will. The volume resistance serves as a smooth, even control of loud-speaker volume, by means of which any desired intensity of sound may be obtained at will.

#### RESULTS OBTAINED DURING AUGUST

DURING the latter part of August, the receiver was tested in the center of the Chicago loop district, among steel buildings, and in comparison with a completely shielded seven-tube super, capable of cutting side-bands, a neutrodyne and several other types of commercial tuned r. f. sets. The "super" gave, using a loop, slightly greater sensitivity. This could be made up by attaching a 20-foot wire to the grid side of the loop on the r. f. set. This was seven tubes against five of similar type. The other receivers were practically worthless on a loop. On a 40-foot antenna, the r. f. set and "super" were even—the point had been reached where the additional sensitivity of the "super" was useless. The other sets tested failed signally to equal the "super" or r. f. set—even to the point of the number of stations heard. Frequently DX stations would operate a speaker on the super or r. f. set, yet could not be heard on the other factory-built sets. The results in selectivity were similar. Either the "super" or r. f. set would eliminate some ten local broadcasters, a few less than 500 yards distant, which completely blanketed the other sets. Side-bands could be cut on any station at will with either "super" or r. f. set, but not with the others. On local broadcasters within one mile, the "super," shielded, was more selective than the r. f. set. Shielding the r. f. set evened things up. This would never be necessary, however, except where the set was but a few yards from a transmitter.

Then a sample receiver was tested in Garden City, Philadelphia was brought in in daylight with plenty of volume to be heard all over the house.

#### CONSTRUCTION OF THE SET

IN BUILDING the receiver, the following material was used. It is suggested that substitution be not indulged in, since many of the

items have been designed for the set. If one substitutes without proper knowledge of the electrical details he is almost courting disaster with the finished receiver.

- 3 Silver-Marshall 350 mmf. S. L. F. condensers
  - 3 Silver-Marshall six-contact coil sockets
  - Silver-Marshall coil forms or wound coils as required, three to one frequency range
  - 5 Naald, Silver-Marshall, or Benjamin cushioned UX or UV sockets
  - 2 Thordarson audio transformers, 3½:1
  - 2 Carter, U. S. L. or Pacent 6-ohm rheostats
  - 1 Centralab 500,000 ohm modulator
  - 1 Carter or Pacent 2-spring jack
  - 1 Carter or Pacent 1-spring jack
  - 1 Carter or Cutler-Hammer on-off switch
  - 1 Muter or Dubilier .002 mfd. condenser.
  - 2 Dubilier or Silver-Marshall .5 mfd. bypass condensers
  - 3 Kurz-Kasch moulded, Ezytoon or plain 4-inch dials, zero-left
  - 1 Belden 5-lead color cable
  - 1 7x24-<sup>3</sup>/<sub>16</sub> inch bakelite panel
  - 1 7x23-<sup>1</sup>/<sub>16</sub> inch oak baseboard
  - 15 Bus-bar lengths
  - 13 <sup>3</sup>/<sub>16</sub>-inch No. 6 R. H. N. P. brass wood screws
  - 10 <sup>1</sup>/<sub>2</sub>-inch No. 6 R. H. N. P. brass wood screws
  - 6 <sup>1</sup>/<sub>4</sub>-inch No. 6 R. H. N. P. brass wood screws
  - 1 Rosin core solder
  - 1 Spaghetti
  - 27 Tinned lugs
- Tools required: Screw-driver, side-cutting pliers, soldering iron and non-corrosive soldering paste, hand drill with drills and countersinks

#### ASSEMBLY

THE panel is first laid out with the positions of the instrument centers as given in the pictorial diagram. These dimensions may be supplemented with the individual templates furnished with each instrument. The holes should be drilled and countersunk where required. The panel may be grained by rubbing lengthwise only with very fine sandpaper and lemon oil, it being finished off with steel wool so that no shiny spots appear. If engraving facilities are available, it may be engraved as shown in the photographs.

While the volume control resistance is shown above and between the two rheostats, it would be better to locate it below and between the middle dials. This would give shorter leads, and leave the space occupied by it in the set photographed free for a voltmeter, which is absolutely essential with 3-volt tubes unless fixed control resistances are used, such as Davens or Amperites.

Each separate part should be examined, and

every nut, screw, and spring adjusted and tightened before proceeding further. Lugs should be put on the sockets, rheostats, and wherever necessary. Then the hole locations may be laid out on the oak baseboard from the pictorial drawing, and each one started with a nail and hammer. All parts should be screwed down firmly in position, using the short screws for by-pass condensers and transformers, the medium ones for the sockets and the long ones for inductance sockets.

The wiring of the set is the simplest of assembly operations. The soldering iron should be heated, the point filed bright, rubbed in paste, and then in solder so that it will acquire a coat of tin, without which it would be impossible to solder. Each lug to be soldered should have the point of a pin carrying a little paste rubbed over it, the iron held to it and the end of the length of solder rubbed on the lug itself, not the iron. This will tin the iron. Another method is to pick up a drop of solder on the iron and deposit it on the lug by rubbing the lug with the iron tip until it is heated sufficiently to cause the solder to flow to it. This makes for neater work, but requires more skill. Rosin on a joint does not hurt it, providing there is solid solder underneath. Do not try to wire with anything but perfectly straight bus bar rolled flat between two boards. Then measure it carefully, cut and bend it to size, tin the ends, and finally solder it in place.

Many constructors prefer to use flexible wire in connecting up sets. In this particular receiver, this is permissible only for the filament, battery, and audio amplifier sections. All r. f. amplifier wiring should be of stiff bus bar, as illustrated, in order not to interfere with the satisfactory operation of the simplified control feature.

So far the panel has not been touched, only the baseboard having been wired. The proper parts should be mounted on the panel. After adjusting the condensers for the desired tension, the panel is screwed to the baseboard and the re-

maining wiring put in, after which the receiver is completed with the exception of the battery cable. This should have its short ends connected to the wiring where it terminates in instrument binding posts, say at the switch, rheostats, and transformers.

INDUCTANCES

IT IS probably simplest to buy machine wound coils, since any variation in wire tension, spacing, insulation, or impregnation will affect the operation of the single control feature slightly.

Using standard ribbed forms, the coils are wound as follows: Starting at the top of each tube with end 3, terminating this winding in 4, beginning again in 5, and ending in 6; 1 and 2 lead to the rotor, used only in the antenna coil. All coils are wound in the same direction with No. 26 d. s. c. wire, except the rotor, which is wound with No. 32 d. s. c.

ANTENNA COILS	1 to 2	3 to 4	5 to 6
1578-545 kc. (190-550 meters)	30 turns	42 turns	42 turns
3331-1428 kc. (90-210 meters)	16 turns	16 turns	16 turns
5996-2726 kc. (50-110 meters)	6 turns	7 turns	7 turns
R. F. TRANSFORMERS	1 to 2	3 to 4	5 to 6
1578-545 kc. (190-550 meters)		84 turns	18 turns
3331-1428 kc. (90-210 meters)		32 turns	7 turns
5996-2726 kc. (50-110 meters)		14 turns	4 turns

In the r. f. transformers, the winding 5-6, or primary, may be wound just over the lower end of winding 3-4, so that end 6 is just over 4. In the commercial forms, this smaller primary is located under instead of on top of the grid coil.

TESTING  
AFTER the receiver has been completed, and the wiring checked against the circuit diagrams, it may be connected up, using one standard A battery as required, say a 6-volt, 90-ampere storage battery for uv-201 A's, one 4½-volt C battery and 90 volts of B battery, consisting of large 22½ or 45 volt blocks. The ends of the color cord are terminated at the batteries, with the exception of the B45 and B90 leads. With these unconnected, a tube inserted in a socket should light, if the switch is on, and the rheostats turned on. If this happens, remove the plus A lead from the A battery, and substitute for it the B45 and then the B90 leads. The tube should not light—if it does, the circuit is incorrect and should be checked for errors. Assuming the tube not to light, all batteries should be connected properly to the set.

With a water-pipe ground connected to either 1 or 2 of the left coil socket, and a 25 to 50-foot single wire indoor or outdoor antenna connected to whichever post (1 or 2) the ground has not been connected to, the set may be tuned, using the three dials. It should first be operated with headphones. The modulator or volume control should be turned all the way to the right, or at maximum. The antenna coil rotor should be so adjusted that its axis is parallel to those of the stator coils. All three dials will read

practically alike—that is, they will all be set at within one or two degrees of each other for a given station. Since each dial division may be assumed to represent approximately 10 kc. with s. l. f. condensers, a station might be easily located.

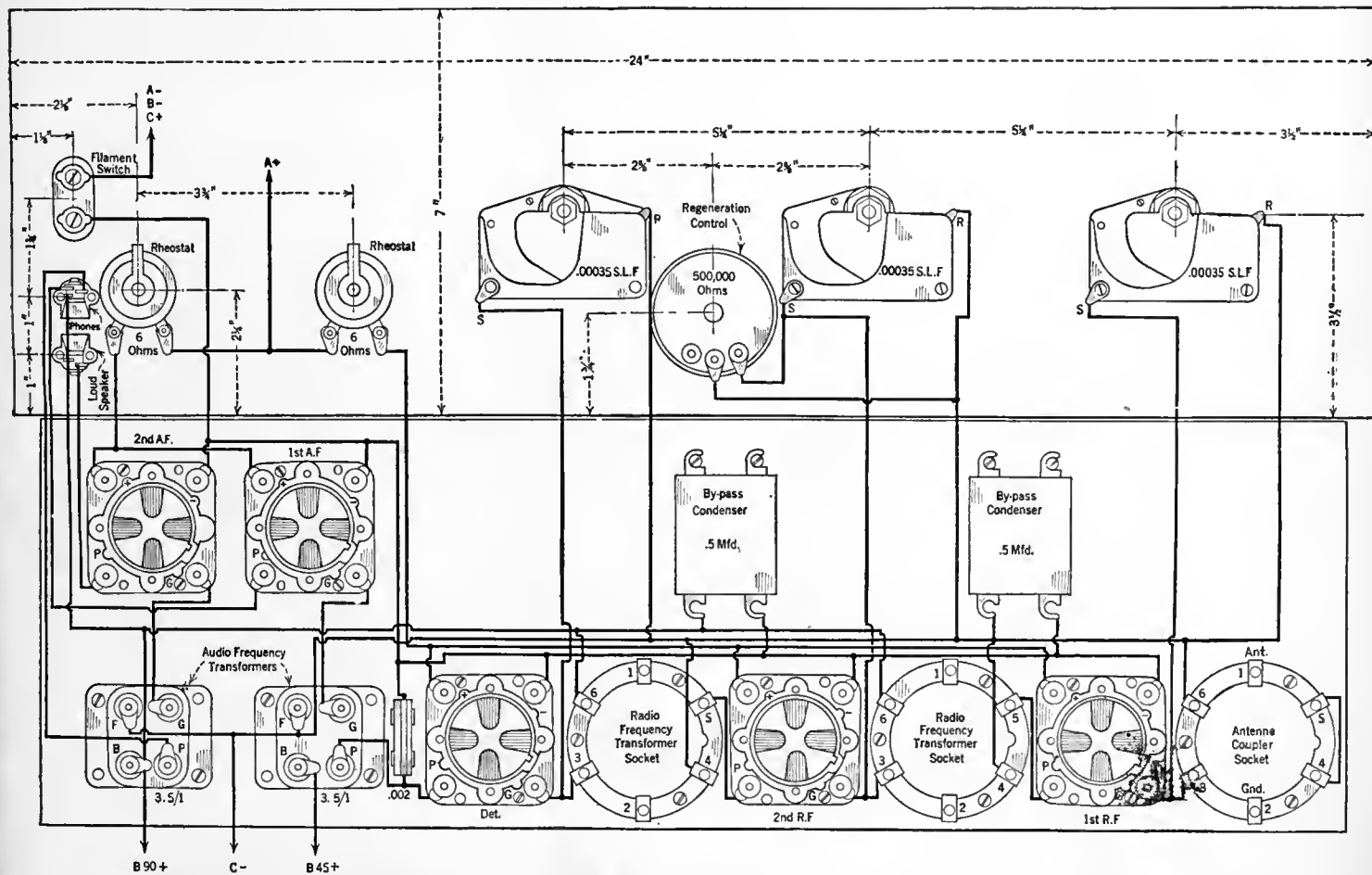

FIG. 4

In this diagram are combined a panel drilling layout, base-board layout to scale for the parts used, and a pictorial wiring diagram

FINDING UNKNOWN STATIONS

FOR simplicity, let us assume that zero on the dials equals 1500 kc. (200 meters) and 100 degrees equals 500 kc. Thus, we have 10 kc. per dial division. Suppose we want WHT, 750 kc. (400 meters) (we get this information from the call book or daily paper). Then 500 kc., our lower limit, subtracted from 750 kc.—WHT's frequency—gives us 250 kc., which, divided by 10 kc.—the frequency variation per dial degree—gives us 25. Thus, setting the dials at 25 degrees plus or minus one or two divisions will tune the set to 750 kc. (400 meters).

Suppose we were using straight line wavelength condensers. The process is different. Our wavelength range covered by 100 dial degrees may be assumed to be 200 to 550 meters, or a range of 350 meters. Thus, each dial division represents 3.5 meters. Suppose we want WHT again, at 400 meters. Then 200—our low wavelength limit—subtracted from 400—WHT's wave—gives 200, which, divided by 3.5—the number of meters per dial division—gives us approximately 57—the setting at which the set will be tuned to 400 meters.

It must be remembered that these figures are at best but approximate, due to unavoidable variation in individual receivers and tubes.

LEARNING TO TUNE

SUPPOSE we want to tune-in some particular station, the proper dial setting for which has been found in the manner previously suggested. It is merely necessary to set the center dial at the figures found, and rotate the remaining two slowly through a range slightly above and below the setting of the other. No doubt a click will be heard indicating oscillation, which will prevent satisfactory reception of stations as they will be heard only as a squeal. This is eliminated by retarding the volume control about one quarter of an arc. If the click is then no longer heard as the dials are rotated, tuning will be found to be quite simple, stations coming in with all three dials set approximately alike.

The system will oscillate only when all three tuned circuits are in approximate resonance—the condition indicated by the click. It should be possible to make the amplifier oscillate when the volume control is retarded not over one quarter. If this cannot be done, the rotor coil of the antenna inductance should be turned out in small steps until this is possible. The volume control regulates the volume of the receiver, as well as the selectivity, in that by means of it it is possible to vary the width of the frequency band passed from about 3 kc. on through the 10 kc. band required for good reception, and then to 25 kc. At this last adjustment, tuning will be found quite simple, as the set will be rather broad—with the volume control set from one half to full left position.

The size of the antenna will affect the position of the antenna rotor. A small antenna requires tight coupling—a long one almost right angle coupling. This adjustment must be found for each particular installation, but once ascertained need not be changed. Under all conditions of satisfactory operation, this antenna coupling will be so loose as effectively to prevent radiation, which could occur only with the amplifier oscillating—a condition not permitting of satisfactory reception. Further, the antenna coupling will also generally be sufficiently loose to eliminate the reactive effect of the antenna-ground system characteristics upon the first tuned grid circuit.

SINGLE OR DOUBLE CONTROL

THIS latter feature is what allows the three dials to read practically alike over their entire scale for different wavelengths. If the first dial is out of relation with the two right-hand ones, the remedy is to turn the rotor until it is nearly at right angles with the antenna stator coil. Suppose we find that throughout the range of the large coils our dials are separated by, say, two degrees each. The correction is simple. They must be turned on the condenser shafts so that they read alike.

It will probably be most satisfactory to use the

receiver as a dual control set, combining the two r. f. dials. To do this, a piece of heavy braided fish-line is necessary; this should be long enough to go around the pulleys on the two condenser shafts without the ends quite meeting. To the ends are spliced short pieces of magnet wire. Then, when the pulleys are joined with the fish-line, the two wire ends may be twisted together and gradually tightened up until all play is gone from the line, and turning one dial causes the other also to rotate. The wire provides a take-up in case the line stretches—since the ends can be twisted at any time with a pair of pincers. It will be found quite simple to release either dial at will, since the drive is purely due to friction. It is merely necessary to turn one dial while holding the other dial steady with a finger. Thus, a full advantage of individual circuit verniers are obtained, yet with a simple, efficient arrangement and no extra equipment.

To connect all three controls, the line is merely lengthened sufficiently to go around both end pulleys, and once completely around the middle pulley. It is fastened in the same manner as previously. Tuning is simpler, although either dial can be released at will by merely placing a finger on the other two to prevent their following the one rotated. If this is done, the simplicity of the panel may be enhanced by using small knobs on two of the condensers, and a large dial on one, since the small knobs serve merely as verniers, and need seldom be touched once the builder has become familiar with the operation through preliminary logging of the set without the simplified control feature.

It is hardly necessary to say that the builder will be well repaid for this effort in building the set—he will be, since it is about impossible to build a practical receiver, equally simple, capable of delivering better results. A hundred stations will not be heard the first night of operation—the set is far too selective for that. It will require several nights of patient tuning before the builder will realize that he really has a better set than his friends.

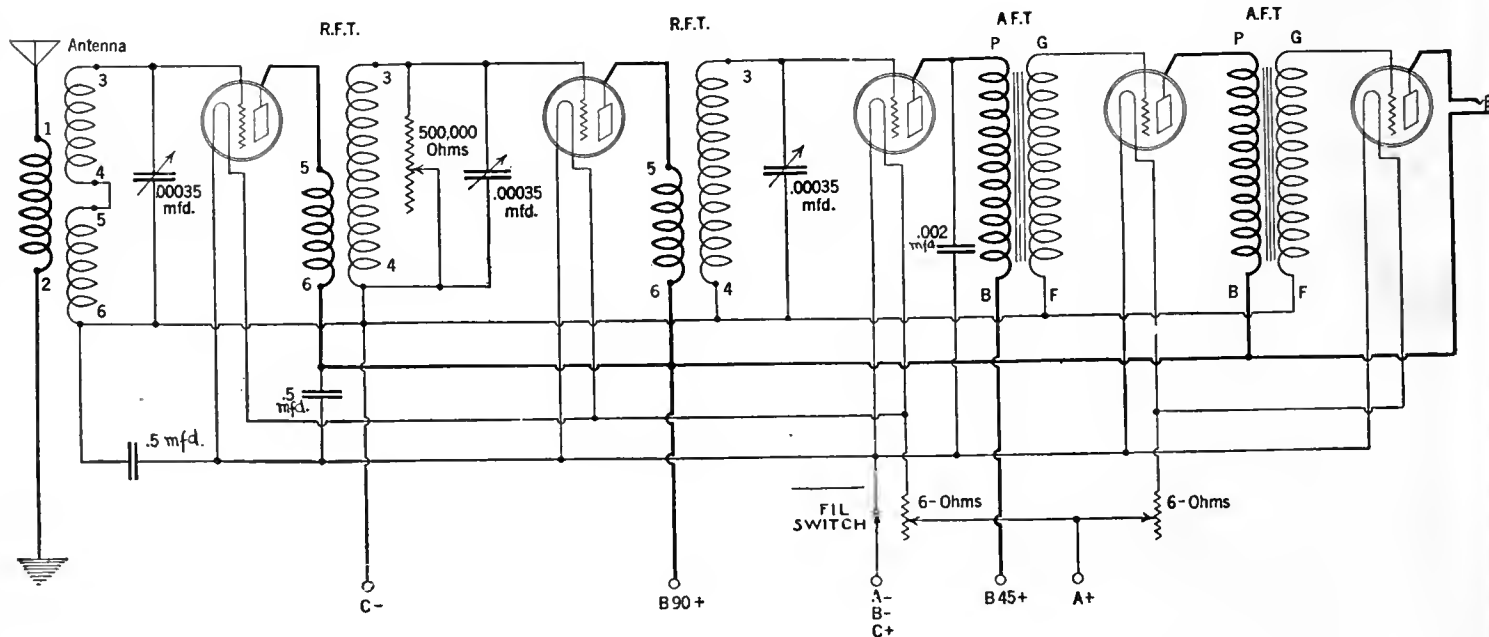
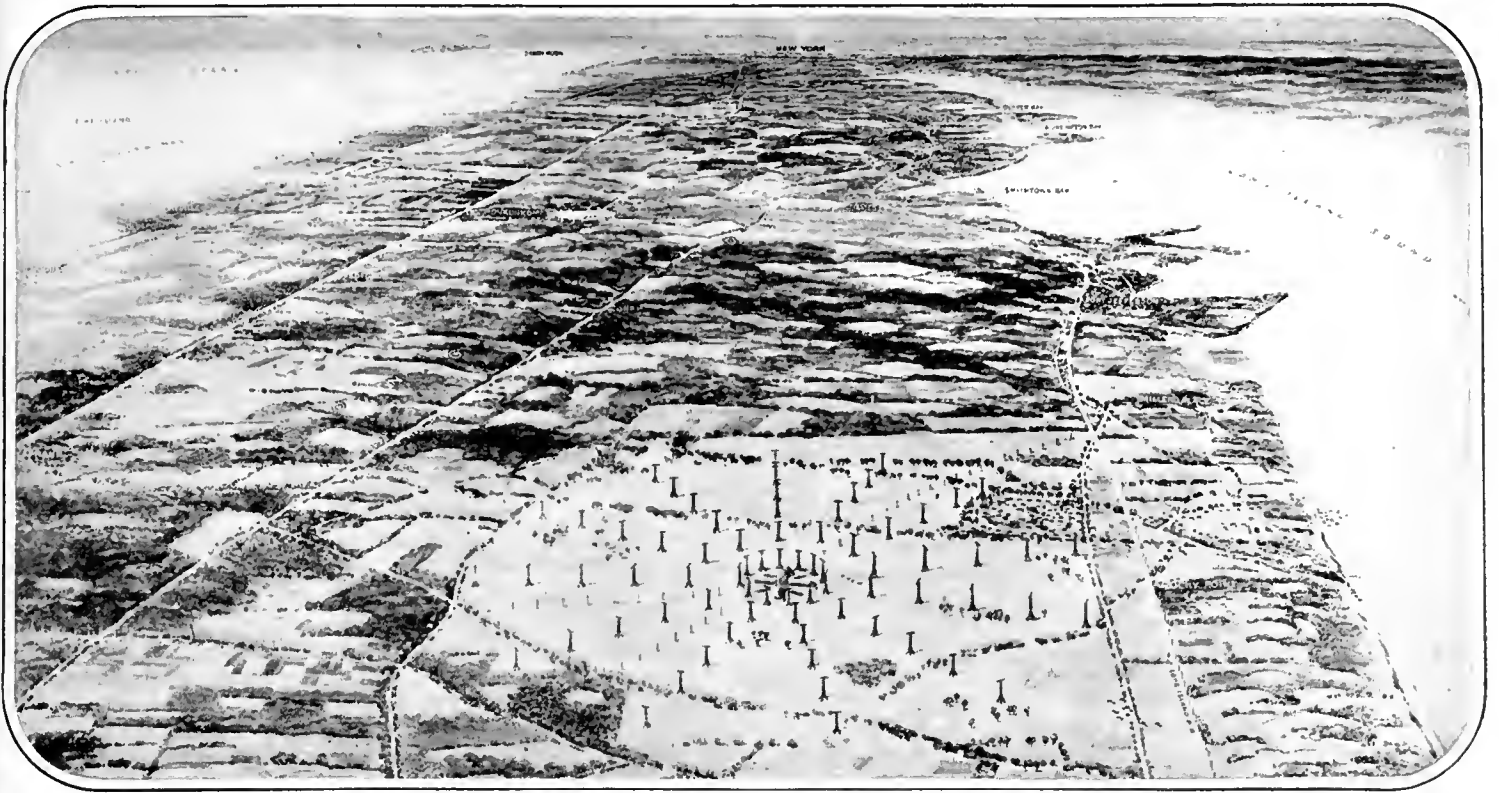

FIG. 5

This is the regular schematic diagram of Mr. Silver's new receiver. This should always be followed in wiring rather than the pictorial diagram, where the fan's knowledge of symbols is adequate.



THE LOCATION OF THE GREATEST RADIO TELEGRAPH STATION

On the American continent. The antennas and transmitting apparatus are located at Rocky Point, about sixty miles from New York. The operators who control the power of this huge station sit at tables in a building in Broad Street, New York. The messages are punched out on a mechanical tape sender and forwarded out over a wire line to the transmitters

# “Radio Central”—Conqueror of Time and Distance

A Visit to the Great Radio Telegraph Station at Rocky Point, Long Island—the Radio Link With England, France, Norway, Sweden, Holland, Germany, Poland, Italy, and South America

By FRED J. TURNER

EVERY minute of the twenty-four hours of the day, every day of the full 365, the dit-dit-da-das of the radio code are shooting through space. And in England, France, Italy, Germany, Norway, Sweden, Poland, Holland, the Argentine, these code characters are being received and translated into messages.

For this, a great human and mechanical organization is needed. Powerful stations are required. Such an organization is the Radio Corporation of America and such a station is the one at Rocky Point, Long Island.

To the average man, an antenna is generally thought of as being a single wire 100 feet long supported from 40 to 60 feet above the ground. The voltage he thinks of in most radio work is seldom higher than 130

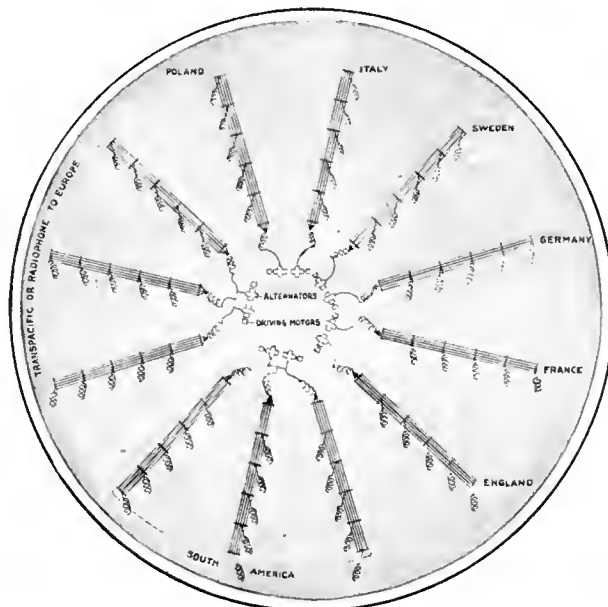

HOW THE GREAT ANTENNAS ARE CONNECTED

and he is, for the main, interested only in wavelengths of from 200 to 600.

Picture two antennas each one and one half miles in length, each consisting of twelve wires having a total length of 18 miles. And then picture the supports of these huge antennas, twelve in all, each 440 feet in height with cross arms 150 in length. Then try to understand the tremendous power that sends the messages, 800 amperes and 120,000 volts, and you begin to appreciate what a remarkable thing a great radio telegraph station is.

Arriving at the station, my first impression was that this was a lonesome spot. No houses were visible. Only one other passenger left the train. An automobile was in waiting and we climbed in. A drive of several miles over a fine, macadamized

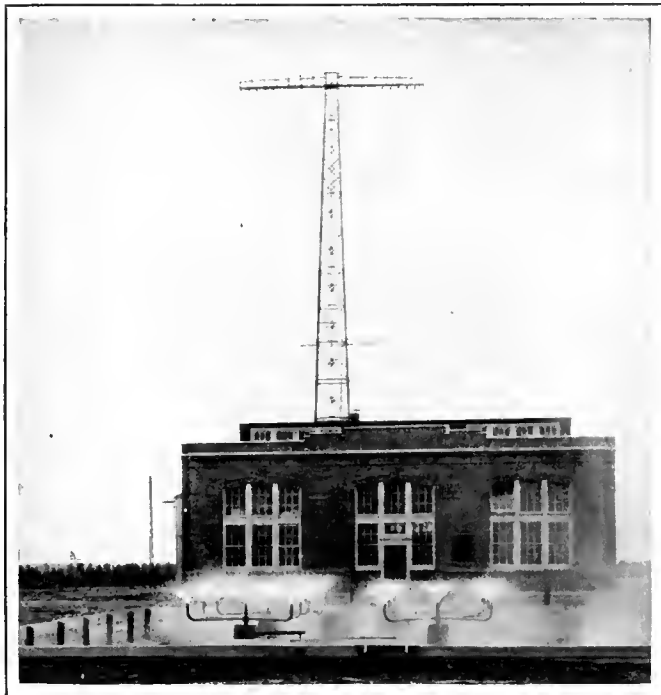

#### OUTSIDE THE POWER HOUSE

The water cooling tanks are shown in action. Some of the water is used in the specially built water rheostats. The 440-foot towers look strangely dwarfed in the picture.

road, a turn into a graveled driveway and our machine came to a stop in front of a long one-storied building. Here I was met by W. H. Graff, the engineer in charge, to whom I presented my pass.

The house I was invited into is called the Community House. It is also known as "Bachelors' Hall," for it is here that the single men employed at the station are housed. The great, long room I saw was both the dining and recreation room. To the right was a billiard table and also a pool table. Dining tables, with their clean white linen and other table equipment, occupied the major part of the left side of the room. A radio set, one of the finest, was near the window. Roomy, restful chairs and settees. A big, open fireplace. The room had much the appearance of a country club.

#### MASSIVE TOWERS

**M**Y FIRST close-up view of one of the great supporting towers was a surprising one. What had looked like tall, slender things, proved to be massive things of steel. Each tower, known as the self-supporting type, is fifty-four feet wide at the base. Each leg rests on huge blocks of concrete. The height of the towers is 440 feet, and the length of the cross pieces, ten feet wide, is 150 feet, or seventy-five feet in each direction from the center of the upright.

There are twelve of these towers. These are divided into two groups, of six each, set 1250 feet apart. They support an antenna containing twelve three-eighth inch copper-clad steel cables, running parallel. Rocky Point is in reality two stations. One is known as WQL and it transmits on 17.15 kilocycles (17,500 meters).

The other, WOK, sends its messages through the air on 18.22 kilocycles (16,465 meters).

Both antennas can be connected in an amazingly brief time, whenever it is found necessary, thus giving one or the other station a three-mile antenna containing fully thirty-six miles of over-head wire. With this great unit messages can be driven through space in an astounding way.

The ground around the station is flat as far as one can see. The absence of trees is also noticeable. This part of Long Island was a forest when it was taken over by the company and thousands of trees had to be removed to provide the cleared space required. The Radio Corporation now owns nine square miles in this section.

A tablet on the front of the building stated that this "Radio Central" station was built in 1920. Now, inside the building, and what a sight! Great motors and generators. Tall and wide panels with many switches, meters, lights, indicators and other things so familiar to those who have visited the control rooms of big electric companies. A caged section to the right could be seen with equipment of varying sizes and shapes set row on row, all connected with copper wires and bars of different thicknesses. Something to one

side spitting out big blue, electric flashes. The familiar sound of dots and dashes. Something about the entire room that bespoke power and mystery.

#### EIGHT THOUSAND DOLLARS FOR ELECTRICITY

**E**VERYTHING in the station, so I was told, had been designed with but one thought in mind, and that was to obtain the maximum of results with the minimum of waste. And it had to be so, for it costs a huge sum to operate a station like this. I understand that the cost of the current used here in one month is in excess of \$8000.

The current used to drive the great motors which in turn operate the powerful generators is taken from the Long Island Lighting Company's generating station located at Northport. It is transmitted over high-tension lines at a voltage of 22,000 at 60 cycles and stepped down after it reaches the radio station to 2200 volts, 60 cycles. As is well known to students of electricity, it is more economical to send electricity along at a high voltage and small amperage, because wires of a small diameter can be used to carry it.

The generators, which are one behind the other, are remarkable machines. Each is known as an Alexanderson 200 kilowatt high frequency generator. The one seen first as you enter the plant operates at 17,130 cycles per second and is used to send messages on 17.1 kilocycles (17,500 meters).

In these generators, which are known as inductor type alternators, there are 976 poles. Generators used for ordinary commercial work have only from 8 to 12 poles.

The motors are each of 500 horse-power and are known as induction motors. Each makes some 800 revolutions per minute. Through a set of step-up gears of a ratio of two and three quarters to one, the steel



#### INSIDE ONE OF THE OPERATOR'S COTTAGES

The company has built living quarters for the staff attached to the station. The married men live in homes like the one shown, while the bachelors have a kind of club, with a dining room, and every convenience.

rotor of the generator is driven by the motor at the required number of revolutions.

Just as the two antennas can be joined and used as one, so can both generators be operated in unison. And there are times when this is done, especially in sending messages over very great distances.

Seeing that my attention was being constantly attracted to a set of long, vertical metal arms which were constantly emitting big, blue, electrical flashes, like dots and dashes, I was told that they were the compensation relays. They were doing for the generator what the steam governor does for an engine. Without those relays there would be all kinds of trouble. When each dot or dash is sent the alternator is called upon to deliver a full load to send it up and through the antenna and out into space. Between each dot and dash the load is released and thus the motor would tend to run faster. In order that the generator can run at a constant speed at all times, these compensation relays close at each dot or dash, allowing the motor to draw from the line the amount of power required to drive the loaded alternator. In the interval between the dots and dashes, the compensation relays open and the motor receives only enough power

to drive the unloaded alternator at normal speed. For those who like precision it will be interesting to know that if there is a variation of one tenth of one per cent. in the frequency of the generator it is not considered to be working properly.

Down at 64 Broad Street, miles away, in New York, operators are seated in front of typewriters punching the dots and dashes on long ribbons of tape. This tape is run through a machine which causes the dots and dashes to be sent along great land cables to this station. They are started from Broad Street with a power of only 50 milliamperes at 120 volts and instantaneously sent through the air by this station with the tremendous force of nearly 800 amperes at 125,000 volts.

One of the very interesting things to see is a water rheostat. Yes, that is what each of the four big box-like affairs really are. As I looked into one of them, and I had to stretch quite a bit to

do so, I saw water rushing over a sort of a dam, set in front of a number of uprights. That dam, I was told, is raised and lowered at the will of the engineer. The higher the dam, the more deeply the uprights, or electrodes, are immersed in the water and the greater, therefore, the amount of current which flows between the electrodes through the water. This water constantly circulates through the electrode compartment and then past cooling coils to keep it from boiling.

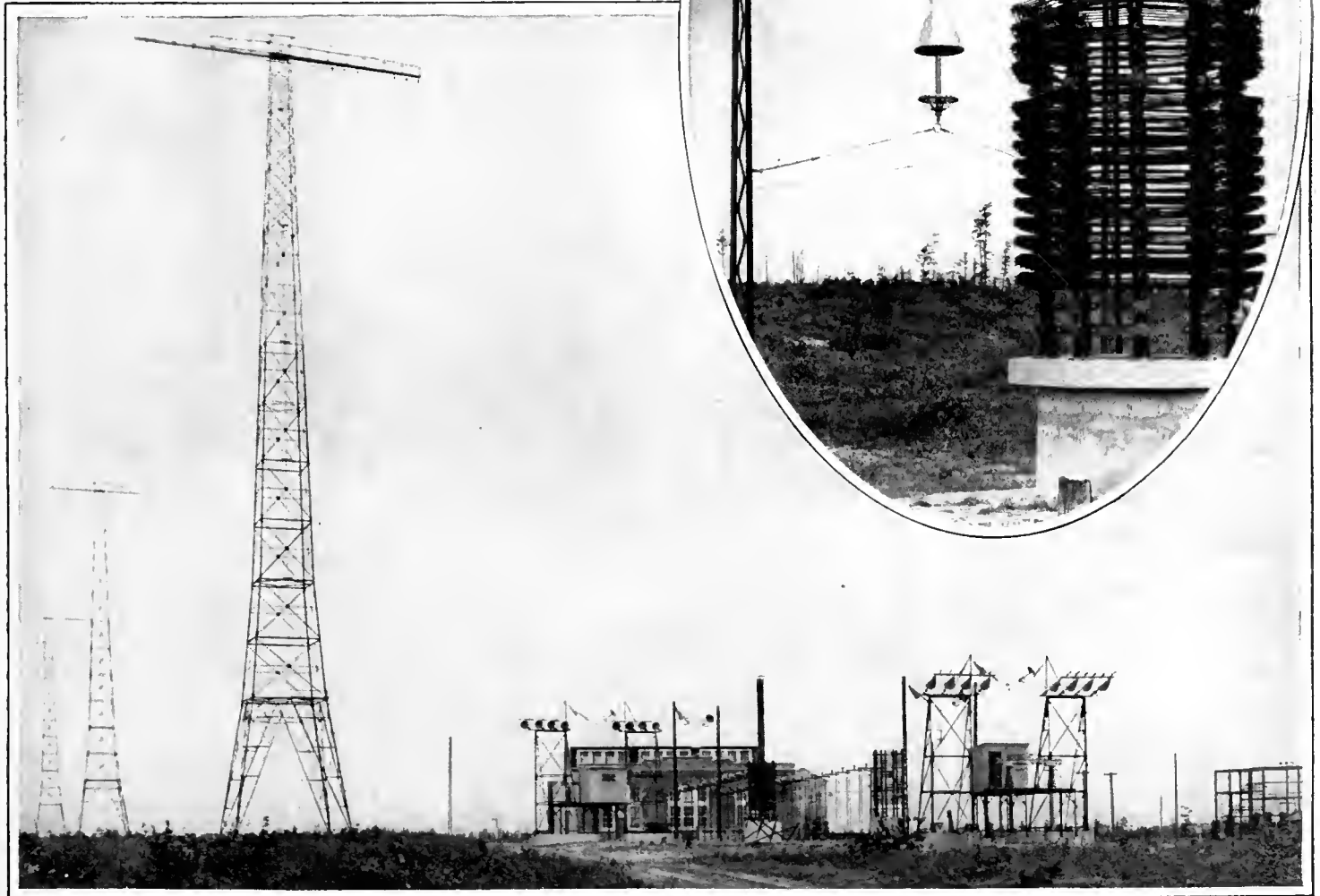

A CLOSE-UP OF ONE OF THE MASTS

And back view of the transmitter house at the great Rocky Point Station of the Radio Corporation of America. The power is fed to the antennas from the wires supported on the quartet of insulators. The insert shows one of the multiple tuning inductances employed in adjusting the wavelength of the antenna. A man's head would come up a bit above the concrete base of the coil support, which gives some idea of its size

## A FOREST OF METERS

CLOSE by, I saw a number of air blowers which were being used to send their cooling draughts along to the relays. It was by this means that the contacts were cooled and the arcs extinguished. (The arcs form when the relays are opened.)

The many meters, as one can see, are so arranged that they are visible from almost every part of the power house. Some of these were pointed out to me. One, a graphic meter, recorded all the variations in generator frequency. Another, close by, showed the frequencies and voltages of the incoming current supply.

Another look at the generators brought forth further information. They are the biggest of their type in the world. The armatures and fields are stationary and the high frequency is generated by large slotted steel rotors. The weight of each is two and one half tons. Each generator has two armature sections, one on each side of the rotor. There are 32 armature coils in each section and each armature coil is connected to the separate primary coil of one of the two air core generator output transformers belonging to each generator.

From the generator the current is passed along into the instruments which I had noticed in the caged section. Signs of brilliant red and big white letters warn of "Danger, High Voltage." A number of big, barrel-shaped things, with regular windings of three-eighth inch wire, I was told, were transformers. A giant variometer caught my eye. What a size! More

than three feet in diameter. It, together with others of a similar size, is regulated from the engineer's position, much like we who are broadcast fans regulate those in our sets. A number of big steel tanks close to the floor were pointed out and I learned that they were the variable impedances that actually controlled the flow of current from the generator output transformers to the antenna. Each of the variable impedances is oil insulated and water cooled.

The impression of bigness grows the longer one remains in the power house. In one section I saw hundreds and hundreds of fixed condensers joined together by ever and ever so many wires. The same kind of condensers used in our sets, but truly monsters when compared with ours.

Now, outside, the first thing I saw was a big coil on a platform. Its height was fully fifteen feet above the platform on which it stood. It is an antenna tuning coil. The current enters this at 7000 volts and leaves it at the top at 125,000. The men here are never careless. Each knows just what he is going to do before he does it. So great is the amount of electricity thrown out by those huge antennas that none of the workers attempts to crank their automobiles until they have grounded the handles by laying a long piece of steel against them. The metal of the automobile takes up the current which is prevented from reaching the ground by the rubber tires.

The insulators which look big from where I stood, I learned were really big. They are of the finest glazed porcelain, each being a hollow tube 72 inches long, three

and one half inches in diameter, with walls one inch thick. At the lower end, looking much like the steering wheels of automobiles, are the corona shields. Dropping over the insulators are the rain shields, called by the men, "petticoats."

At one side of the power house are small structures of metal on elevated platforms. Into each of these structures each of the twelve wires of the antenna terminate. At this point the twelve are converted into one by a series of switches, and as one wire is carried to the big antenna tuning coil. From there it goes to the power house. In the winter these metal structures are used for melting the ice and sleet which form on the antenna wires. If this were not done, the tremendous weight would cause them to fall to the ground. By sending a 60 cycle current through each wire, sufficient heat is created to melt the ice.

Looking up at those giant supports and meeting the long straight ladders that lead to the top, a platform at each 100 foot level breaking the climb, one cannot help but admire the nerve and skill of the riggers who work away up there.

There are five more huge tuning coils, one connected to each antenna at regular intervals throughout its length, in addition to the one just outside the power house. These insure the most efficient distribution of current over the entire antenna and ground system. This system is known as the multiple tuned antenna.

The ground system of this station is extremely interesting. Running parallel with the antennas, one on each side, are a number of telegraph poles, supporting a dozen or more wires. These, of course, are the same length as the antennas. Around each pole, about one third the distance from the ground, is a wire coil. Each coil is smaller the further away it is from the power house. Direct contact to the ground is made from them.

It can now be understood how this ground system is used. With a single ground connection, all the current would be concentrated in one spot and a great deal of energy would be wasted. A large number of ground connections, each receiving only a fraction of the total current, ensures low resistance and maximum efficiency. It will no doubt surprise many to know that two hundred and forty miles of bare copper wires are buried in the earth under the antennas for ground connections.

Before leaving I could not help stopping to look at the power house again and I got quite a thrill thinking that at that moment messages were being sent from New York over great land lines, through the many instruments inside the building and out into space to England, France, Italy, Holland, and the other countries almost as quickly as I could wink my eye.

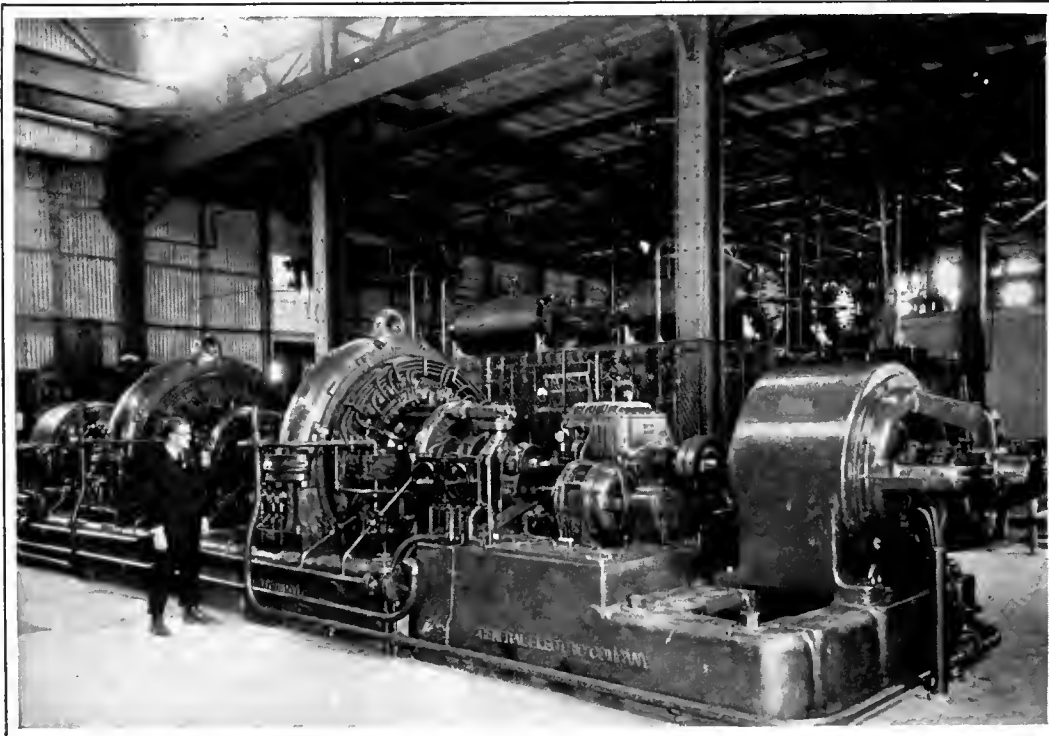

TWO ALEXANDERSON ALTERNATORS

Each of 200-kw. capacity, used to furnish power to the antennas. These machines, developed by Dr. E. F. W. Alexanderson of the General Electric Company, are much different from the usual commercial type of alternator in that they develop radio frequency current which is fed directly to the antenna. The armature and field coils are stationary and a carefully balanced rotor causes the magnetic fluctuations necessary to produce the current



# AS THE BROADCASTER SEES IT

By CARL DREHER



Drawings by Franklyn F. Stratford

## The Complicated Business of Running a Broadcasting Station

**I**NGENERAL the work of a broadcasting station falls naturally into two divisions, getting the programs, and broadcasting them. A third and indirectly connected function is that of securing publicity for the station's programs and achievements in newspapers and other publications. Three sorts of people, therefore, work at a broadcasting station: the program organizers, engineers, and publicity representatives. Musicians should be added as a fourth class, for, as we shall see, musicians as well as engineers are needed for the actual broadcasting, as well as in arranging the programs. The musicians function in the no man's land between the program and engineering departments. I refer, of course, to the musicians attached to the station staff, not to the artists or performers, with whom this article is not directly concerned.

Fig. 1 shows one possible organization chart of a good-sized broadcasting station. The great mogul on top is not the same in every station. On a newspaper which has gone in for broadcasting he may be one of the editors or the promotion manager. He may be the president or the vice-president of a radio company or any other organization that has entered the radio field. In the case of a university he may be a professor or dean. What happened in all these instances was the intrusion of a new activity into a more or less settled organization, engaged in selling chewing gum or operating a telephone system or in teaching or what not. Some executive, with or without qualifications for the task, was entrusted with the job of broadcasting.

Often the head of the enterprise took the new responsibility for himself. At any rate, this "manager or other executive" is the man who makes the ultimate decisions, who decides how much money shall be spent, what the policies of the station shall be, and other matters of that sort. He may not be found at the offices of the station, and he may have a lot of other things to do besides broadcasting, but his is the guiding hand, and, if he is not himself one of the chief executives or owners of the enterprise, he reports directly to them.

From this officer, the organization line splits into a number of divisions: program, publicity, and technical. There may be some variations. For example, if the station broadcasts for toll, and has an income, there may be a head accountant or bookkeeper. Again, the publicity man may not report directly to the executive; he may be a member of the program department. And often, of course, various diverse functions may be assigned to one man, complicating the chart in ways which need not be taken up here. If the station

is large, instead of one position shown on the chart, there may be a number with the same title. For example, there might be two music critics instead of one, as shown in Fig. 1. In presenting this chart, the object has been to make it inclusive enough for large stations and yet as simple as possible. Thus stenographers and general office workers are not included, and special workers, such as statisticians, who may be employed in some instances, are also omitted.

The work of the publicity representative is probably the least unfamiliar to the general reader, since press agents antedated broadcasting. However, it is not quite the same job in a broadcasting station as in a theatre or hotel. The publicity man goes around to the various radio editors in his town and tries to keep on amicable terms with them. They are necessary to him and he is also necessary to them, for he supplies them with material for their pages, material which may be written by a copy writer or by the press representative himself. The members of the publicity staff are also in contact with the artists, who give them photographs and data for articles, which, if they are interesting enough, get into the newspapers. Part of the publicity man's duty, also, is to attend to the printing of programs well in advance, sending them to newspapers, and calling up those in his own town, on all broadcasting days, to make corrections in these lists, for there is many a change in the programs between booking and modulation of the carrier. This information the press man secures from the booking de-



IT TAKES ALL KINDS OF PEOPLE TO RUN A BROADCASTING STATION

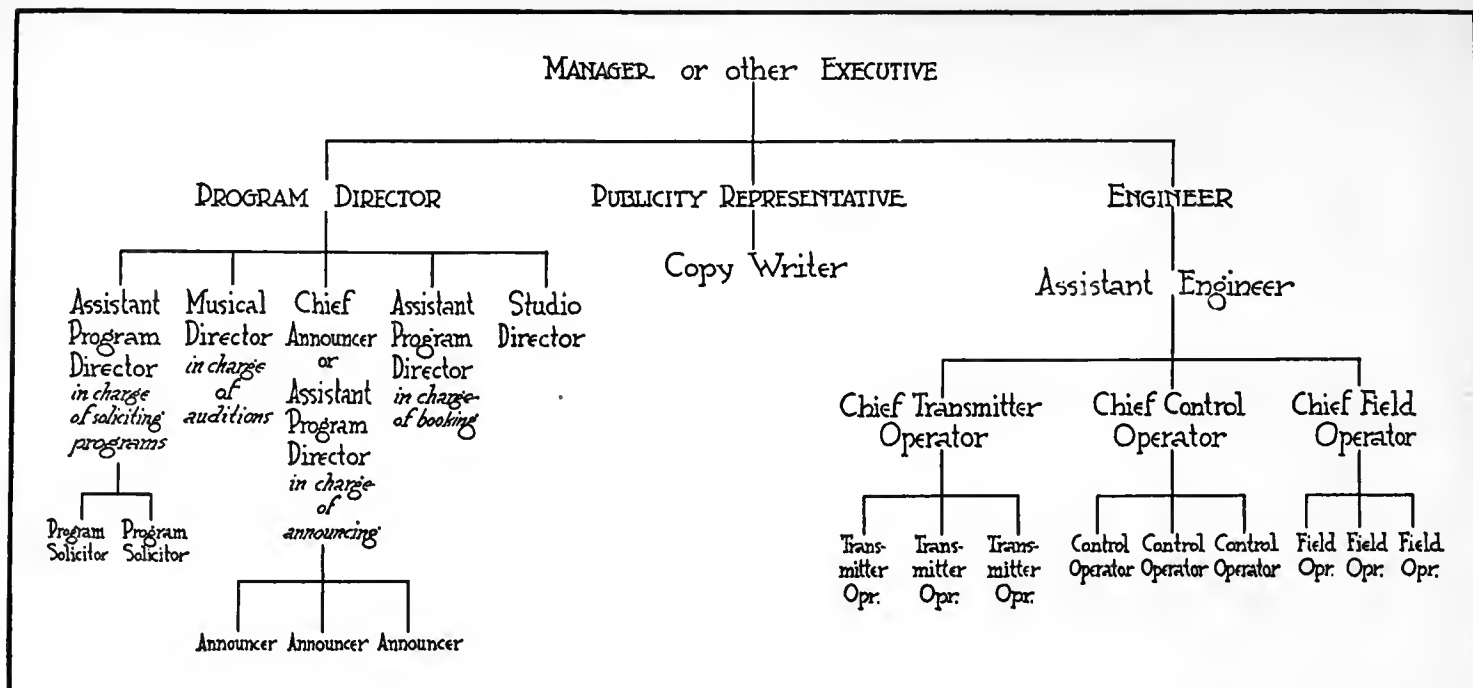

FIG. 1

"Organization chart" of a typical large broadcasting station. Mr. Dreher explains how the affairs of a typical station proceed—from the inside. A broadcasting station is a business organization, frequently one of some size, but the public knows very little about broadcasting except the impression gained from whatever they hear from the announcer

partment of the station. Publicity activities include photographing, of course, this being handled, ordinarily, by a professional photographer who does such work for the station as the publicity representative may direct. A scrap book is also kept, and the publicity representative may hand in occasional reports on the amount of space he has been able to secure, since the object of every station is to be well known, and a good press agent helps in that endeavor as much in broadcasting as in saving souls or governing the country.

The program director, like the chief executive to whom he reports, may have come into broadcasting from anywhere. Some of them are ex-concert managers, with a wide acquaintance among musicians. Others are ex-newspaper men. Still others are musicians, theatrical booking agents, actors, clergymen, to name a few of the vocations which might be mentioned. The oldest program manager in the New York district, in point of experience, is a mechanical engineer. What a program manager does doesn't matter; his duties are to keep in touch with the public and its desires, to see that the station gets the best program material available, to mould the programs in accordance with station policy, to coördinate the work of his department, to report to the management and to exercise various other special and executive powers. In a large station, if he saw everyone who tries to see him, he would hold his job about a week before the hospital claimed him. His assistants protect him to some extent.

Among these assistants there may be a subordinate program director in charge of soliciting programs. He may have a squad of program solicitors under him, or he

may do all the work himself. If so, he is primarily an outside man, going around interviewing prospective broadcasters. He keeps a sharp watch on the newspapers for reports of what may turn out to be "features." If the station is one which sells time, he is a sort of advertising solicitor, seeking customers, aiding them to arrange suitable programs, etc.

Just as a magazine gets a certain number of unsolicited contributions from writers, so a good many artists, some very good, some very bad, visit a broadcasting studio to volunteer their services. Hence a musician must be attached to the staff to give these people auditions and weed out the poor ones. He may do this at a time when the station is not on the air, and serve as the accompanist of the station when it is broadcasting. He disposes of the aspirant he cannot use as tactfully as possible, and sends the remainder to the booking agent of the station, who is in a position to arrange for a definite time when they may broadcast. The musical critic should, if possible, be equipped with a suitable microphone pick-up, audio frequency amplifier, and loudspeaker, so that he may hear applicants about as they will sound on the air, for some people with satisfactory concert voices do not transmit well, owing to the limitations of present-day electrical reproduction.

The booking agent of the station may be an assistant program manager, or the program director's secretary. He or she must be in close touch with the director in order to carry out his wishes in making up the program, assigning desirable times in accordance with the importance of events, and so on. Generally, the booking official knows pretty well what the program

director will approve, and does not have to ask him in the majority of cases. The system of booking programs works with the program book as its basis, which is marked in quarter-hour intervals for all the time the station has on the air. When an event is booked, the appropriate spaces are filled in several weeks ahead of time, as a rule, and the program people can tell at a glance what time is still free. Thus a program solicitor may come to the booking clerk and ask, "What time have you free after 8 p. m. on November 3rd?" if he has something in mind for that date. The booking agent is also responsible, as a rule, for making sure, on the day of broadcasting, that none of the performers have forgotten their dates or will be unable to appear for one reason or another. He has another job—that of furnishing lists of events booked to the publicity man, engineer, and announcers, so that suitable action may be taken, schedules made out, etc. And, every day, the program for the day, correct in every detail, is issued to all the operating and announcing forces concerned.

So far we have been more concerned with making up the programs than with broadcasting them. The latter job is principally in the hands of the technical force, and it will be taken up in more detail in our next issue, when we expect to print an article on "Technical Routine in a Broadcasting Station." The operating personnel is headed by a technical man, styled variously as "Chief Operator," "Engineer-in-Charge," "Chief Engineer," or blessed with some other mellifluous title. Sometimes he is a graduate electrical engineer, sometimes he is not; but in any case his function is to see that the amperes flow

in the antenna, when needed, and that they are modulated as accurately as may be, on whatever speech and music the station is supposed to broadcast. The actual work of broadcasting, in the larger stations, is handled by a squad of operators or junior engineers, and the technical man in charge, like the program director, is something of an executive in addition to his specialized functions. But in most stations, probably, the engineer wears headphones and turns knobs. Assuming, however, that the station is a big one, the technical work is divided into outside or field pick-up, and internal station jobs. The field work is usually handled by a Chief Field Operator, who may have a considerable number of assistants, up to a dozen in some cases. He makes up the schedules for these men and usually handles some of the important jobs himself. The inside work may also be directed by a Chief Inside Operator, but frequently the control room of the station is separated from the power plant, so that a Chief Control Operator and a Chief Transmitter Operator are separately responsible for the work in these two departments. The control room is in close association with the studios, while the power plant is isolated; the former handles only relatively weak currents, while the latter deals with dangerous voltages and powers. Thus the qualifications for the various technical positions, inside and outside, vary widely. The operation of a good-sized station, with perhaps a score of engineers and operators on its staff, is quite a complicated enterprise, and the complications increase in proportion to the number of outside events where program material is carried to the station proper by wire lines. The routine and methods of technical broadcast operation will be taken up in detail in later issues, together with the tasks of the studio director and announcers, who work with the engineers in the actual broadcasting of the programs.

### A Forgotten Romance: German Radio in Africa

POSSIBLY it should be called a tragedy. It is one of the stories of the war, of radio in war. As far as I know, it was never printed in the United States. A German radio and telegraph engineer, Doctor Roscher, wrote it for *Archiv für Post und Telegraphie*, August, 1920.

Before the war the Germans had a colony, Togoland, in West Africa. As early as 1909 they decided to place a wireless station there for communication with Berlin. The site chosen was Kamina, four miles from the terminus of the Hinterland Railroad.

"At last, on the night of the 7th of June, 1911," says Dr. Roscher, "after some two years' trying, signals were picked up for five minutes from the great station at Nauen. But before this was achieved mast

after mast had been destroyed by tornadoes, and when the first signals from Nauen reached them it was through a captive balloon some 450 feet up, as substitute. At the same time they heard Poldhu, Cornwall, talking." This "talking" was in telegraphic code, of course.

After prodigious labor in the tropical jungle, the station was completed on June 20, 1914. It had three steel masts 225 feet high, and six 360 feet high. The power was supplied by two 500 hp. turbines and two of 120 hp. By day it transmitted to Nauen on 6000 meters, by night on 4500. During the night it received, when it could, through the appalling equatorial static.

A few weeks after completion of the station the war broke out. It is said that 800,000 tons of German shipping were saved through the activities of this transmitter. It handled traffic from South America and Germany. Naturally, it was not left alone for long. The French advanced against it from Dahomey, the British from the Gold Coast Colony.

On August 27th the station was destroyed by its own personnel, in a few hours, by "explosions and smashing," in accordance with contingent instructions from Berlin. The enemy was then 30 miles away, in such numbers that successful resistance was out of the question.

"Finally," the account reads, "they proceeded to overthrow the nine towering masts by loosening the couplings at the

foundation blocks. Like a row of gigantic ninepins they went down, one after another, with a terrific metallic ringing noise, heard, it appeared later, far away in the silence of the night."

Five years of research, five weeks of service, and suicide. That was the career of the German station at Kamina in Togoland, which began and ended long before radio waves received their modern burden of jazz, grand opera, and inspirational talks.

### Rebuttal in the Discussion of Super-Power

*In the October magazine, Mr. Dreher and Professor Williams aired out the question of super-power broadcasters as opposed to the service which can be rendered by 500-watt stations. Professor Williams, of station WHAZ, Rensselaer Polytechnic Institute, Troy, New York, has accepted the opportunity to reply to Mr. Dreher's remarks in the October RADIO BROADCAST and they appear below. The views of Professor Williams and Mr. Dreher are not necessarily those of the editors. Professor Williams said, on page 764 of our October issue, that this magazine had "reversed its position on 500-watt stations." That is not the case. We are simply giving a hearing to both sides. Insofar as the present discussion is concerned, the debate is now closed.—THE EDITOR.*

IN THE articles appearing in the September and October numbers of your magazine on the subject of super-power broadcasting stations, Mr. Dreher, unable to meet the facts brought out in the fields of electrical engineering, automobiling, and cash register use, all of which were selected by him, jumps into the field of



SOME ONE IS ALWAYS EXPLAINING THE MYSTERIES OF RADIO



RADIO INVESTIGATION IS AS FASCINATING AS THAT IN OTHER FIELDS

physical optics, drags Galileo and his telescope into the argument, and ends—I am sorry to say—by a rather harsh criticism of his opponent.

If radio broadcasting were carried on between two perfectly definite power levels, radio receiving sets could be designed to function satisfactorily in the hands of the radio public between those limits. This does not exclude the super-sensitive sets for scientific and industrial use any more than the fact that the human being has eyes excludes the use of the telescope or microscope in similar fields.

I do not know how much experience Mr. Dreher has had with the difficulties of properly adjusting telescopes and microscopes, but, from my own experience, I am thankful that my eyes function satisfactorily for most purposes without the aid of these complicated instruments which require so much skill for their satisfactory use, and at the same time are very expensive. Similarly, I am for a broadcasting system which will operate between fixed power levels so chosen that a relatively simple and inexpensive receiving set will function between these levels satisfactorily for general use, and will not require a great amount of technical skill on the part of the listener to operate it. While Mr. Dreher is unwilling to grant a high order of technical intelligence to the listener, he advocates putting in his hands the type of instrument which requires a maximum of technical intelligence to operate. This simply proves that he misunderstands the radio public, and does not know that the present trend in the manufacture of receiving sets and tubes is in the direction of making the complete receiver as near fool-proof as possible.

Nature has been very kind in not placing the sun in the direct line of vision at the time when the light rays from the sun are most intense and by placing the sun behind the earth at night in order that the earth's inhabitants may enjoy the moon or star-lit heavens without any interference from the sun's rays. If Mr. Dreher can devise some scheme whereby he can shut down his super-power stations altogether, or remove them so far in space, time, or wavelength from the other broadcasting stations so that they will interfere as little—with the programs now being broadcast—as the sun interferes with our enjoyment of the heavens at night, I do not believe that any one will object, and he can enjoy his super-power stations to his heart's content.

My opponent accuses me of not being courageous enough to enter the radio field against him. It was not lack of courage, but lack of a mean

disposition, and, even now, after a second challenge, I would rather not do it. However, let us look into this little computation of his. He is a very clever and interesting writer and uses a lot of words to prove simply this: If you have 500 watts and increase it to 50,000 watts, everything else remaining constant (presumably, including the science of mathematics) you have one hundred times as much power on the antenna, and therefore one hundred times as much power at all other locations. Now, if he had had as much experience as I have had during the last fifteen years trying to transmit energy at different power levels to the points where you want it to go, instead of into copper roofs, water-pipes, steel buildings, etc., he would never have penned that article and misled his readers into believing that they were going to receive one hundred times the volume from WGY's 50,000-watt transmitter, on its first test, that they receive from our 500-watt transmitter. This is no argument against super-power, but against the deplorably misleading statements one reads in the radio press. Station WHAZ stood by on August 24, 1925, to allow WGY to complete their transmission tests, and our staff was as disappointed as the WGY staff with the results. It was my good fortune to be listening in at one of our test stations and the increase in power level at that location was almost nothing.

The set I was operating is one we are at present using for field strength measurements. It makes one of the best receiving sets (I did not make it) I have ever had. On several occasions I have loaned this set to B. C. L.'s and they have been invariably dissatisfied with it, the reason being that it requires as fine and delicate adjustment as a high-grade microscope and when not properly handled will absolutely ruin the best program beyond recognition.

Mr. Dreher's other contention regarding the advantages of one or two steps of amplification at the transmitter rather than at the receivers reads as easily as the one just discussed and is as misleading. Here again he assumes ideal conditions which do not exist. The simple fundamental error made in his assumption is that a receiving set receives energy only at the frequency for which it is tuned. He intimates that I have never listened to DX. Well, I have, and I have not only amplified DX signals to loud speaker value but have sent them out through our experimental station 2 XAP with sufficient power and clearness to be heard in California without appreciable distortion. These re-broadcasting experiments were carried out in

connection with other experiments, the primary purpose of which was to determine the facts regarding the sensitivity and selectivity of the most widely used receiving sets already owned by the B. C. L.'s. Station 2 XAP was used as an interfering station with different amounts of power in the antenna and at different frequencies (wavelengths). The receiving sets were located at various points at different distances from 2 XAP. These experiments proved conclusively that increasing the power level of the interfering station, which is usually a local station, by as much as one or two steps of amplification prevented us from receiving stations which could be received at the lower power levels of 2 XAP with good enough quality for re-broadcasting purposes. It could not be expected that conclusions drawn from radio engineering experiments carried out through two cold winters would agree with opinions formed in a steam-heated New York City office. You must decide for yourselves which are of greater value.

Space will not permit me to tell you the little I know about transatlantic radio telephony and telegraphy and how international broadcasting will be accomplished. I will content myself with the statement that our station has already been rebroadcast on the other side of the Atlantic, and I am not really as ignorant on the subject as Mr. Dreher would have you believe.

I cannot agree with my opponent in his final conclusion to the effect that talk on this subject is of no value. If he really has a set that can be interfered with by a cat rubbing his back against the fence and cannot pick up a 500-watt station only one hundred and fifty miles away, we have learned something from his side of the argument, granting my points sum up to zero.

## The Memoirs of a Radio Engineer

### VI

IN 1910 I graduated from the elementary school, and a little later my family moved to another house, where I started what may not have been an innovation, but it was certainly an early use of an expedient now very common—the resort to an indoor antenna where it is not feasible to erect one outdoors. The landlord objected to my trespassing on the roof of his three-story treasure, on the ground that I would wear through the sheet iron and cause the roof to leak, that I might fall off, that an antenna would be unsightly, that it would attract the unchained lightnings, etc., etc. So I strung two wires about fifty feet through our apartment and, as the neighborhood was one of frame structures, obtained satisfactory results, as the times went. I had a crystal detector, consisting of a piece of silicon, ground flat and smooth on one surface—God knows why, but the current superstition was that silicon should be used in that way—and imbedded in solder, with a blunt brass point pressing down on it. This was attached to the antenna and a gas pipe ground, and a 75-ohm receiver, swiped from some telephone desk set, connected in parallel with it. Once in a while this combination picked up signals very faintly. They were probably those of near-by amateurs. After a while I got together a tuner—a cardboard mailing tube about

two inches in diameter, wound with No. 24 enameled wire, and provided with two sliders making contact with a bare swath the length of the winding. This constituted a conductively coupled system, with a tuned antenna and approximately tuned secondary or detector circuit. It was quite effective, remarkably so in comparison with the untuned set, and it was further improved by the substitution of a galena—cat whisker detector for silicon. Picking up a signal was no longer an achievement; it could be accomplished almost any time. The United Wireless station at 42 Broadway, New York City, came in fairly loud, although about eight miles away. There was also the Wanamaker station, MHI, in New York, communicating with MHE in Philadelphia—perhaps this was a little later; it is rather hard to remember down to a year after fifteen of them have rolled by. The rest were largely amateurs. I also had a transmitting station. My parents had bought me a quarter-inch spark coil, in a quartered oak case. In my own room, which measured about eight by ten feet, I strung up an antenna of aluminum wire, which was popular at that time, consisting of about a dozen wires forming a grid which covered the whole ceiling. The spark coil, operated from dry cells and keyed by some crude spring and knob arrangement, when connected to this antenna and a ground, was heard by an amateur about five blocks away; we engaged in conversation, and he paid me a visit, declaring that I came in louder than some of the boys with outdoor antennas. The spark gap, I recollect, consisted of zinc electrodes turned out for me by a boy who attended Stuyvesant High School and had access to the machine shop there. Among other amateurs in the neighborhood, some were using long single wire antennas at a time when multi-wire ones were all the fashion, until, on the advent of broadcasting, the single wire antenna for reception came into its own. Many quaint superstitions regarding antennas and other radio subjects raged among these innocents. For example, it was declared, on the strength of an article in a periodical, that "the wavelength of an aerial was four times its mean height above the instruments." There was one comrade, it happened, who had a sloping antenna running from his roof to a clothes-pole, with a horizontal lead to the set, the lower end of the antenna being about as far below the apparatus as the upper end was higher. In a discussion on wavelengths, in which everyone boasted of the great length of his own wave, one of his rivals taunted this fellow, saying, "You ain't got no wavelength," and backing his argument with the article in question. Confronted with the fact that the antenna radiated audible signals, he merely shrugged his shoulders and admitted that there might be signals, but, properly speaking, no wavelength existed. I do not remember the name of this dialectician, but he deserves high honors, for he

is the forbear, in the radio field, of a great multitude who substitute words for sense, and they should keep his memory green.

It was in the early part of 1912 that I wrote my first radio article, for which I received the sum of 65 cents. It was a description of a Tesla coil, fed from the quarter-inch spark coil which also furnished the oscillations for my transmitting set, and it was certainly one of the smallest Tesla coils ever made. The secondary or high frequency winding covered an ordinary small test tube, the turns being No. 30 silk-covered wire carefully spaced by hand and dipped in wax. Over this were wound a few turns of heavy weather-proof wire, in parallel with a leyden jar across the spark gap of the induction coil. The secondary of the Tesla converter gave a one half inch high frequency spark, which, being confined to the surface of the body, could be taken without sensation—a great opportunity for fooling other boys who believed that an electric spark always meant a severe shock to any one monkeying with it. The same credulity was being exploited by some vaudeville acts built around large Tesla transformers, throwing sparks several feet long, which enabled the actors or "professors" to announce that they could withstand potentials of millions of volts where a mere 1800 would kill an ordinary man in the electric chair. The distinction between high frequency currents and d. c., and the matter of the number of amperes actually flowing through vital tissues, were of course unmentioned in these acts.

For the July, 1913, issue of *Modern Electrics* I also wrote an article on "indoor aerials," which won the third prize of \$1.00. Recently, in looking up this publication, I was amused to note that the second prize in that issue (\$2.50) was captured by Harold Beverage, who was probably at that time a student at the University of Maine, or, more likely, preparing for his college course, as I was. He was not writing about antennas, in fact, his contribution was electrical in nature and really had nothing to do with radio. About six years later this boy was to invent a new type of antenna, the "wave antenna," whose highly directional properties, eliminating the bulk of the static on trans-oceanic reception, marked a great step forward in high power commercial radio.

In 1912, however, antennas were not

yet familiar objects, and the indoor variety, particularly, seemed very strange to most people. They could not conceive of waves penetrating wood and glass and other solid objects. One friend of my father's came to the house and listened attentively to the wireless signals, but when he asked whether I had an antenna on the roof, and I pointed to my indoor wire, he declared vehemently that I was hoaxing him, and that the signals were being cooked up somewhere in that room. I argued with him for a long time, and grew very angry, for I was young and it irritated me to be accused of fraud when I knew that the signals were genuine and there was nothing extraordinary in such reception. I had not yet learned the truth of Schiller's saying, "Against stupidity the gods themselves fight in vain," an aphorism which the progress of the engineering arts has not affected in any way.

*The Country Is Saved!* Advertisement of a manufacturer of automobile accessories entering the radio field:

Hiccough & Co. Radio—the *ensemble* radio—is now ready!

The good news has been hard to keep! Extreme secrecy has guarded every move and discovery of Hiccough engineers, who have for more than two years been engaged in the solution of a tremendous problem—the *perfection of radio!* Yet for months the radio world has been atremble with the rumor that "something revolutionary in radio is about to be announced."

So the announcement of Hiccough & Co. is not a surprise because everybody has been expecting it. You know you yourself have been waiting for a concern like Hiccough & Co. to take the uncertainties, disappointments, and troubles out of radio and give you only real results.

*Italics and exclamation marks not ours. At last! Radio is to be made perfect—by a manufacturer of automobile accessories.*



THE LANDLORD OBJECTED TO TRESPASSING ON HIS TIN TREASURE

# Improving the Cone Loud Speaker

**C**ONE-TYPE loud speakers, particularly the Western Electric Loud Speaking Telephone No. 540AW, when used with a receiver not designed especially for use with them, may be greatly improved by a few simple adjustments. If these suggestions are followed with care, a greatly improved signal will result, and the speaker itself will not be harmed. It is no es-

pecial secret that many Western Electric engineers make these adjustments on speakers used on their own radio sets. This is the first time that information for doing the trick has been made public. The operation, in the parlance of the engineers, is called loading.

The first operation necessary is to loosen the small thumb screw at the apex of the cone. It is well to wind a rubber band around it after loosening, to prevent its becoming lost.

The second operation (see Fig. 1), is the removal of the five screws nearest the center, at the rear of the speaker. Removing these



FIG. 1



FIG. 3

screws permits the metal ring, the composition ring, and the metal shield which they hold in place, to be removed and leaves the mechanism open to view. The third operation is the removal of the three screws which hold the mechanism in place on the main frame.

The fourth step in the procedure is to remove the small screw to which the screw driver is pointing in Fig. 2, and to place a small piece of friction tape between the two metal parts the screw holds

together. Of course, a small hole must be cut in the tape to permit the screw to pass through. Then the piston of the driving mechanism (see Fig. 4) is wound with rubber tape which is tightly stretched. In applying the tape to the piston, great care must be used to avoid bending the pin.

After the driving pin has been wound with rubber tape as shown in Fig. 3, the tape should be vulcanized by burning a match under it. After the tape is vulcanized (see Fig. 4) it will not loosen while the speaker is in operation. With this step, the alterations to the cone are complete and re-assembly is begun. First, place the driving mechanism back in place and hold it there temporarily by bringing up the three supporting screws with their lock washers. This mechanism must be centered, and that may be accomplished by shifting it one way and another before the supporting screws are brought up tightly. Following this, it is but necessary to replace the parts removed and tighten the thumb screw and the job is done. The sound produced by the remodeled cone is greatly improved.

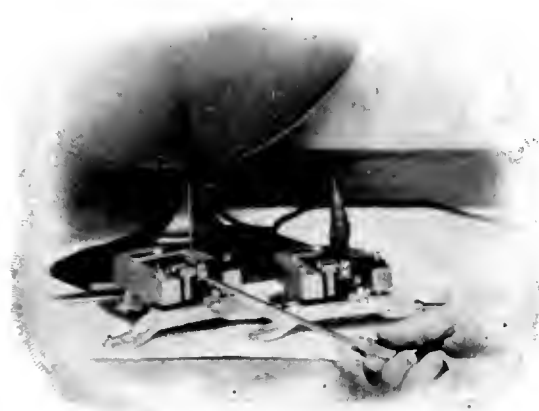

FIG. 2



FIG. 4

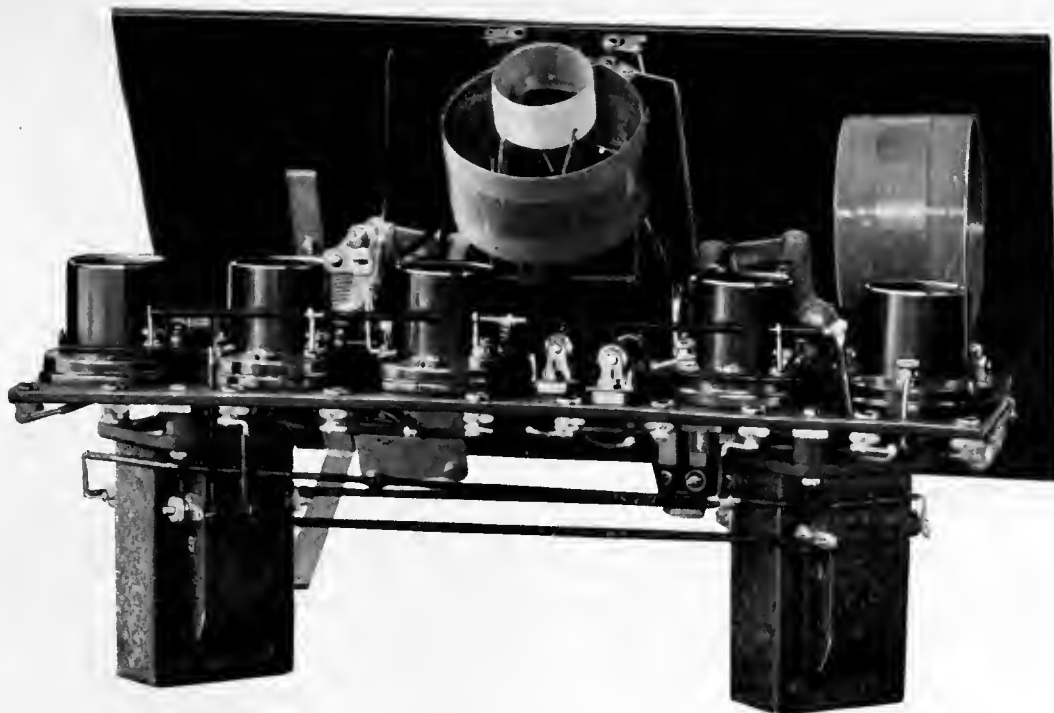

FIG. 1

A rear illustration. By means of small bushings, the audio-frequency transformers are underslung from the bottom of the shelf. In order from right to left the tube sockets are, first audio-frequency amplifier, radio-frequency amplifier, detector, and the last two are the two parallel tube sockets of the second stage audio amplifier

# An Improved Five-Tube Receiver for the Inexperienced Constructor

The Crystallization of Modern Improvements in Receiver Design—Especially Arranged for Ease of Assembly and Operation

By ARTHUR H. FULTON, Jr.

**A**LONG with the developments in receivers to be made public for the fall radio season comes one which, in the estimation of its designers, is very high up in the scale. A great deal of time and study and many hours have been spent in the laboratory to produce a five-tube receiver—improved electrically especially in the unseen parts that are so important—that would give to the inexperienced constructor a receiver which would contain the best results of design and at the same time have a finished commercial appearance. A receiver has been designed which is very easy to assemble. All the constructor needs is a soldering iron, a few other tools, the parts, and the ambition to complete the job.

The term assembly is used advisedly because it can hardly be said that the receiver to be described entails either elaborate

construction or detailed layout, dimensioning, or the necessity of machine shop equipment.

Electrically, the circuit embodies and incorporates every important and worthwhile refinement of control and accuracy of coil design that can be approached in factory-made jobs. Here is a receiver employing a tuned, neutralized radio-frequency amplifier which has unusually

*THE*RE is a story behind the development of the receiver described in this article. It was felt that there were a large number of radio enthusiasts, not especially gifted mechanically, who would welcome the design of an outfit which would take the guesswork out of home receiver construction. It would be possible, thought the designers, to produce a highly efficient five-tube non-radiating receiver embodying all the best points of the Roberts Knockout receiver—which, month in and month out, continues to be the most popular receiver for home construction in use in the United States to-day—and to select a group of the best parts obtainable on the market, even to the panel. So the result is a design which we can heartily commend to any constructor who wants to build an efficient receiver with as few mechanical difficulties as possible, and who, when the thing is completed, will have a set whose appearance is as finished as a factory-made product.

high “gain”, a regenerative detector followed by a straight stage of audio-frequency amplification, and that in turn followed by a special power amplifier consisting of two tubes arranged with their elements connected in parallel.

No reflex feature is employed in the circuit, which sets this design off from the conventional Roberts Knockout circuit, which is, in many ways, similar. The high degree of selectivity and sensitivity of the five-tube set may be attributed to these modern improvements and changes.

Going one better than the orthodox kit idea, the designers of this receiver so arranged its construction that with the aid of a basic unit consisting of the panel, shelf, and miscellaneous hardware, it is possible for the builder to patronize his local radio dealer in the choice of the various other elements necessary for the construction of

—THE EDITOR.

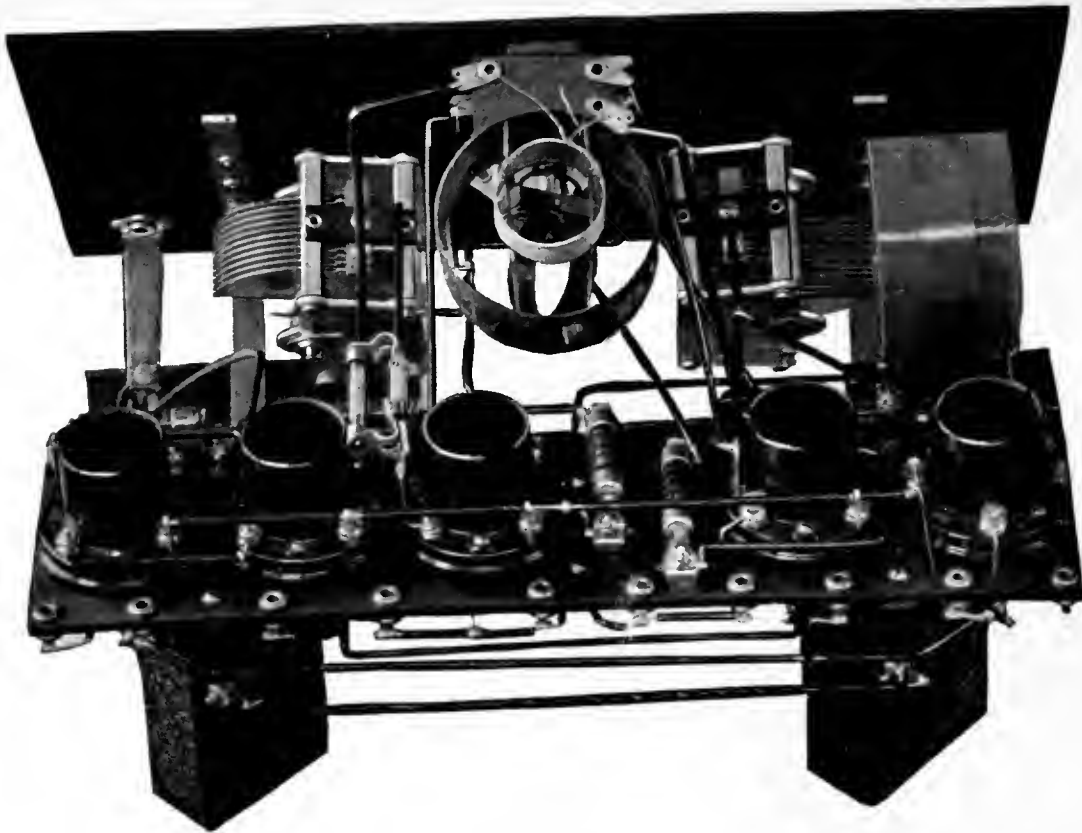

FIG. 2

The apparatus behind the panel. This view clearly shows the location and placement of the sockets, ballast resistances, and pin jacks on the shelf. Note that the coil units are at right angles to each other

the set. Instead of working from a set of blue prints on to a panel, the constructor has the opportunity of buying the panel ready-drilled, together with the other essentials, and merely assembles the rest of the material which goes to form the completed receiver. Brackets, cut and bent to shape, support a shelf upon which a majority of the apparatus, such as tube sockets, audio-frequency transformers, ballast resistances, and the neutralizing condenser are mounted in the completed job.

#### THE APPARATUS USED

IN ITS mechanical and electrical design, consideration has been given seriously to the employment of none but the best apparatus obtainable (all of which has been tested and approved by the Laboratory of RADIO BROADCAST). In its present form, the construction and operation of the receiver has been modified to simplicity with the inclusion of ballast resistances for all but one tube, one output jack for the loud speaker, and pin jacks for battery terminals mounted on the rear of the tube shelf. Following the trend of modern design, the receiver has been constructed on a slanting panel and is entirely self-contained thereon, the apparatus being mounted either directly on the panel or on the shelf supported by the brass brackets which are fastened to the panel.

High grade audio-frequency transformers employed in the audio amplifier, together with the peculiar parallel arrangement of the last two tubes, insure distortionless quality output.

In this receiver the tubes are not situated in the conventional manner, but in order from left to right looking over the top of the receiver are: first audio, radio frequency, detector, second audio (this last named consists of two tubes connected in parallel).

Volume is controlled by means of the filament rheostat connected in series with the filament of the radio-frequency tube.

The tuning coils used permit of the reception of signals from those stations which operate on the higher frequencies (low wavelengths) and will amply cover those stations situated at the other end of the scale.

The tuning is reasonably sharp on the antenna coil control due to the absence of reflexing. Tuning in the detector circuit is the same as before and is comparable to tuning a regenerative receiver by the squeal method. Briefly, to tune with this method, the tickler is well advanced to produce regeneration and by rotating the detector tuning condenser, squeals will be heard every time the circuit beats with the carrier wave of a station transmitting at that time. Once a desired station is located in this manner, the squeal can be eliminated by loosening the coupling between the secondary and tickler. While, in the standard three-circuit regenerative receivers this system would play havoc with other receivers in the neighborhood, in this receiver, due to the use of the Roberts system of neutralization which is a positive preventive, no squeal is passed along to the antenna to cause disturbance.

Three views of the receiver shown here indicate its commercial appearance and mechanical design, and by means of the prepared parts, duplication in design by all those attempting its construction is assured. The models shown differ in some points of mechanical refinement from the receivers it will be possible to construct from the commercially available units.

Considering the individual variations in the construction of receivers described in radio periodicals, and realizing the troubles encountered by constructors in modifying original designs to suit their own fancies, it is not difficult to appreciate the special attractions and favor of a plan which will minimize the detailed dimensioning, layout, and assembly of receivers.

Analyzing the circuit in Fig. 4 the salient features herewith described are apparent.

#### ELECTRICAL DETAILS OF THE CIRCUIT

IN THE receiver illustrated, the variable condensers  $C_1$  and  $C_2$  are shunted across their respective secondary coils, the first secondary functioning as a combined primary-secondary, in auto-transformer fashion, but in the finished model, a separate antenna coil has been provided. These condensers are of the standard .0005 mfd. value. The condenser  $C_3$  is that with which neutralization is obtained and is of the value of .000032 mfd. Two by-pass condensers,  $C_5$  and  $C_6$ , are employed, one across the primary of the first audio transformer, and B battery in its circuit, its value being .001 mfd. and the other a .006 mfd. one, connected from the minus A to the



lower end of the plate coil in the radio-frequency tube circuit.

A tickler having variable coupling with the detector secondary provides regeneration. The grid leak condenser C<sub>4</sub> is .00025 mfd., shunted by a grid leak of 2 megohms. The value of the grid leak will vary with the particular detector tube used.

Low ratio audio-frequency transformers of the latest design, having large iron cores upon which are wound large coils, should be used. This sort of transformer gives equal response on all the audio frequencies, insuring good quality of signal.

The unusual system of parallel tube amplification is practically new to the radio broadcast field, and is intended for the prevention of overloading in the last audio amplifier.

Two major controls afford tuning over the entire broadcast range. These are the tuning condensers; the detector circuit is so designed that its tuning is slightly sharper than the antenna circuit. As previously explained, regeneration adds to the simplicity of tuning, and the control for the tickler coil is located in the top center of the panel.



FIG. 3

A clear representation of the method of supporting the coils, shelf, and brackets. The audio-frequency transformers are mounted at right angles to each other to minimize magnetic coupling effects

This improved five-tube receiver employs the following parts, others, similar, can be selected from apparatus approved by RADIO BROADCAST:

1 Neutralizing Condenser, .00032mfd. (Hammarlund)	\$ 1.80
2 Audio-frequency Transformers, Rauland Lyric, @ \$5.00 ea.	18.00
2 Condensers, .0005mfd. (Hammarlund), @ \$5.00 ea.	10.00
2 Dials, 4 inch, Na-ald, @ \$.75 ea.	1.50
1 Dial, 1 1/2 inch, Na-ald.	.25
4 Ballast Resistances, Amperite, @ \$1.10 ea.	4.40
1 set Roberts Coils, Hammarlund	6.00
5 Sockets, Na-ald, @ \$.75 ea.	3.75
1 Rheostat, 25 ohms, Carter	1.00
1 Filament Switch, Carter.	.65
10 TipJacks, Union, @ \$.25 a pair	1.25
1 Single Circuit Jack, Carter	.70
1 Grid Condenser, .00025mfd., Dubilier	.50
1 Grid Leak, Durham	.40
1 By-pass Condenser, .002mfd., Dubilier	.45
1 By-pass Condenser, .006mfd., Dubilier	.65
Panel, Hardware, sub-base etc., Hammarlund	9.40
	<b>\$60.70</b>

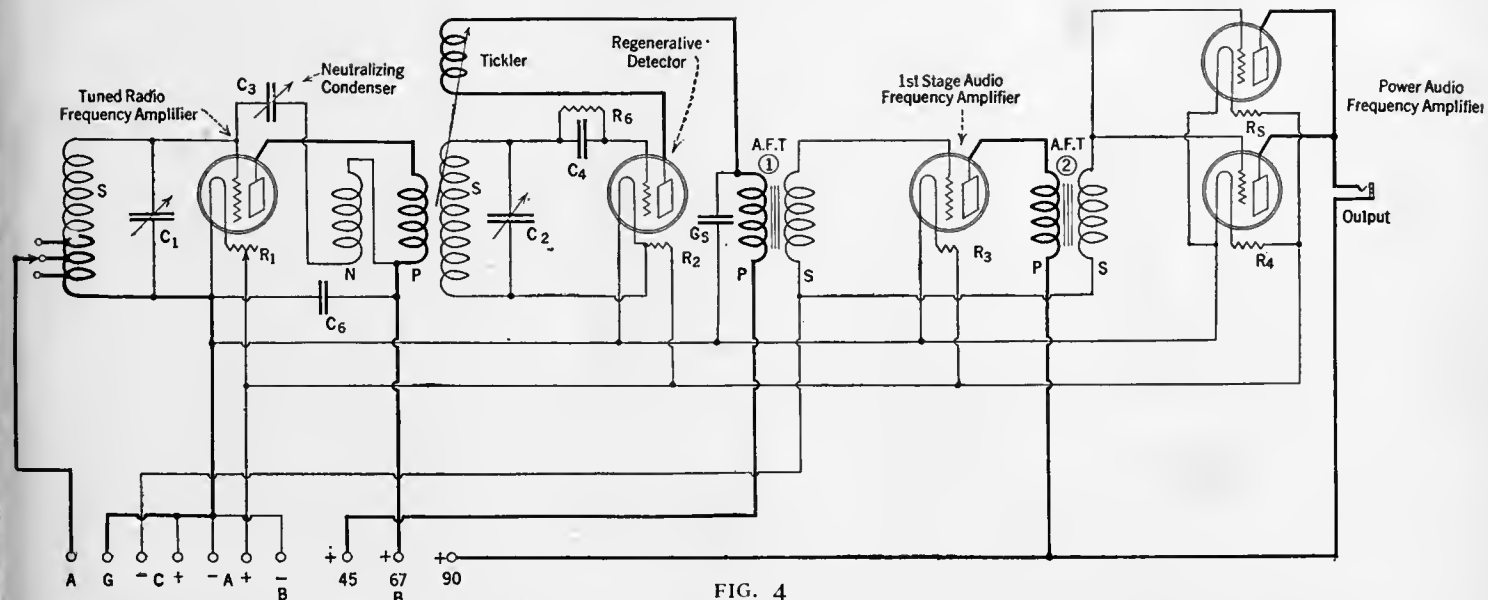

FIG. 4

The circuit diagram of the final receiver differs slightly with the diagram here in that a separate antenna coil is provided in place of the auto-transformer arrangement shown. This antenna coil has three leads, the two ends and a center tap which allows of correct adjustment of the antenna coupler with the particular length of antenna used. The values of the various apparatus employed are: C<sub>1</sub> and C<sub>2</sub> = .0005 mfd.; C<sub>3</sub> = .000032 mfd.; C<sub>4</sub> = .00025 mfd.; C<sub>5</sub> = .002 mfd.; C<sub>6</sub> = .006 mfd.; R<sub>1</sub> = 25 ohms, R<sub>2</sub>, R<sub>3</sub>, R<sub>4</sub>, R<sub>5</sub> = 1/2-ampere filament ballast resistances; R<sub>6</sub> = 2 meg; AFT<sub>1</sub> and AFT<sub>2</sub> = 2 to 1 audio-frequency transformers. Note the parallel arrangement of the last two tubes. The neutralizing and primary windings of the r.f. coupler are indicated as a double-wound coil, but in reality it is a single-wound coil with a tap taken off the middle turn

# What Do We Know

The Fascinating New Problems of Radio High Frequencies—A Distinct Branch of Are Yet to Be Discovered—How Radio

By KEITH

*Director, Radio*

Aside from the frequency and the power used, the other factors limiting our transmission are the time of day, the type of antenna, and nature of the country between the transmitting station and the receiver. At night, conditions are vastly different than during daylight—as all radio enthusiasts know. The effect of intervening objects has not been completely investigated.

Other conditions theoretically remaining the same, increasing the transmission frequency (decreasing wavelength) widens the radius over which signals from our station may be heard. If the frequency is increased we find that our range increases accordingly until at 7000 to 12,000 kilocycles (40 to 20 meters) we can communicate during the daytime over distances that are considered very good at night on the lower frequencies (longer wavelengths). At the same time, we seem to find that our signals are not heard near by, but that they take a peculiar jump and come down again at some greater distance. This view is maintained by several experimenters, notably John Reinartz, and yet remains to be proved or disproved.

THE CLOCK IS IMPORTANT IN SHORT WAVE WORK

ALTHOUGH greater distances may be covered with a medium power, the reliability of communication suffers, for fading and other disturbing effects become quite noticeable. At still higher frequencies, the time of day is of great importance, but so little is known of transmission on the highest amateur band, 60,000 kilocycles (5 meters), that it is unsafe to make any definite assumptions of what actually happens.

The MacMillan Arctic expedition of last year was out of touch with civilization for many weeks because the operators were not equipped to route their traffic over the very high frequency (short wavelength) bands. The expedition this year has been in continual touch with amateurs in this country as well as those in England, Australia, and other far distant lands. The communication last year was accomplished on 1500 kc., while this year it was chiefly accomplished at 7000 kc. While the expedition was in continual daylight this year, it was necessary to use still higher frequencies, and successful communication was carried out with amateur station 9 cxx in Cedar Rapids, Iowa, on the extremely high frequency of approximately 20,000 kilocycles (16 meters).

*THERE are a surprisingly large number of broadcast listeners who are able to understand what goes on in the always interesting amateur radio channels. The fact that the amateurs use code almost exclusively has not prevented these ambitious ones from buckling down and learning the code, setting up equipment—which costs less than many a home-assembled super-heterodyne—and reaching out themselves over astonishingly great distances. This article announces experiments which are bound to be of interest to “transmitting amateurs” and the many broadcast listeners whose interest in radio is broadening out. The RADIO BROADCAST-Everyday*

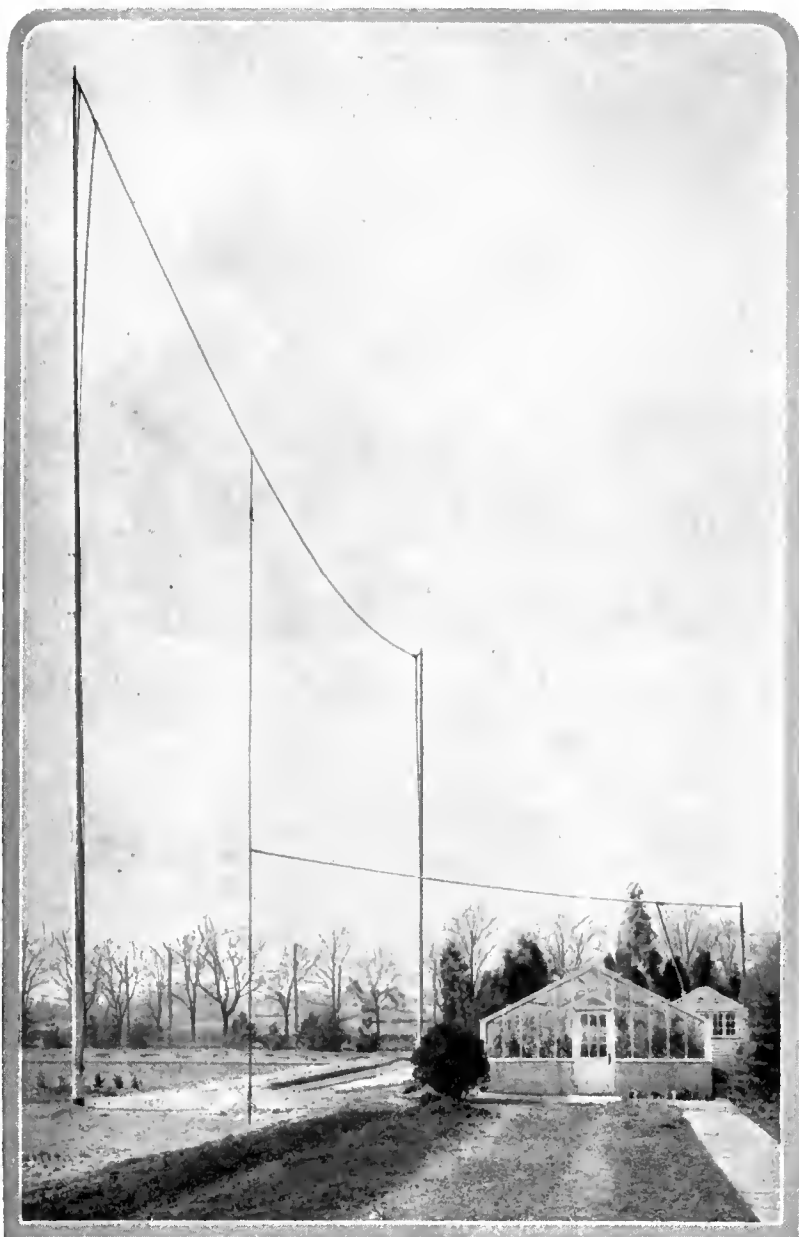

RADIO BROADCAST Photograph

## THE TRANSMITTER HOUSE AND ANTENNA AT 2 GY

Where the RADIO BROADCAST-Everyday short wave experiments are in progress. The “driver” antenna can be clearly seen above the small operating house in the right foreground. The main 40-meter antenna is suspended vertically from the supports between the two 85-foot masts

WHEN radio amateurs first explored the region of the very high frequencies, say beyond 2000 kilocycles (100 meters and lower) the phenomenal distances covered with low power were attributed to the total lack of interference encountered there. Then as these high frequency ether lanes became the common property of thousands of amateurs, it was realized that the results obtained there were due to other causes than freedom from interference.

What these other causes are has been the subject for considerable speculation among the radio learned, and the experimental work carried out to discover the laws governing transmission at high frequencies has been very valuable. To aid in this experimental work, the Laboratory of RADIO BROADCAST has in operation a station work-

ing on high frequencies under the amateur call of 2 GY. This work will be prosecuted during the coming winter with the cooperation of the National Carbon Company in an endeavor to learn all that is possible of what goes on on the higher frequency bands.

To see what happens at these higher frequencies, let us perform a hypothetical experiment at our transmitting station. Starting with 1500 kilocycles (200 meters)—the wave used by all amateurs in the “good old days”—let us see how far, on the average, we may transmit with a given power.

# About Short Waves?

## Transmission and Reception on Very Radio Investigation in Which Many Facts Enthusiasts Can Join the Experiments

HENNEY

Broadcast Laboratory

Communication between the S. S. Peary at Etah, Greenland, and 2GY has been successful at night on 7000 kilocycles, but not a sound could be heard from the expedition in daytime until our receivers were tuned to the higher frequencies.

What takes place along the high frequency bands? How far may one expect to carry out reliable communication in daylight, and at night, with a given amount of power and at a given frequency? Do signals actually jump over near-by stations to reappear at some much greater distance? What is the relation between time of day and distance of transmission? What of seasonal differences? Of increase in power? Are some frequencies good at certain hours and not at others?

These and other questions are assailing every true radio investigator. Station 2 GY was established to work on the high frequency bands, and considerable time and energy will be devoted to the solution of certain particular aspects of these broad problems.

### AID OF EXPERIMENTERS IS WANTED

TO AID in this work, the staff of the RADIO BROADCAST-Everyday short wave experimental station are compelled to call upon other amateurs. To this end the Staff is desirous of hearing from all amateurs who may be able to aid, either by listening to transmissions from 2 GY at definite periods or in other ways to be arranged.

At the present time, the station is experimenting in two directions. One has to do with antenna systems and the other is the relation between power and reliability of communication.

A brief description of the antenna now in use at 2GY will explain the manner in which other amateurs may aid in this work. A single vertical wire, one half wavelength long (about 65 feet) is "fed" by a transmission line from the transmitter which is working on the so-called 7000-kilocycle (40-meter) band.

The questions to be answered are, what is the proper length, one half wavelength, or more or less? At which point along the antenna should the driver wire be attached? What are the best methods of indicating resonance? What is the effect of using two or more parallel vertical wires, each tuned to the transmitting frequency? Should the wire be vertical or horizontal?

Those who have studied the classical wave theories in

*experiments will give all interested experimenters an opportunity to take a personal share in as interesting an experiment as we know of and this article tells something of the problems which have to be solved. High frequency (short wave) transmission in the last two years has set the radio world by the ears and the more that can be found out about the strange phenomena the faster will radio advance. Succeeding articles in this series will tell more about the progress of the experiments, which will, we think, be of great service to all the experimenters in this field, and which will, we hope, further the interest of the veriest of fans in this engrossing subject. — THE EDITOR.*

## CHAPTER IX

### EXPERIMENTS ON THE IDENTITY OF ELECTRIC WAVES AND LIGHT

**Hertz's Apparatus for Shorter Electric Waves.** — After Hertz had succeeded in proving that the action of an electric oscillation spreads out as a wave into space, he planned experiments with the object of concentrating this action and making it perceptible to greater distances, by putting the oscillator in the focal line of a large concave cylindrical mirror. In order to avoid the disproportion between the length of the waves and the dimensions he was able to give to the

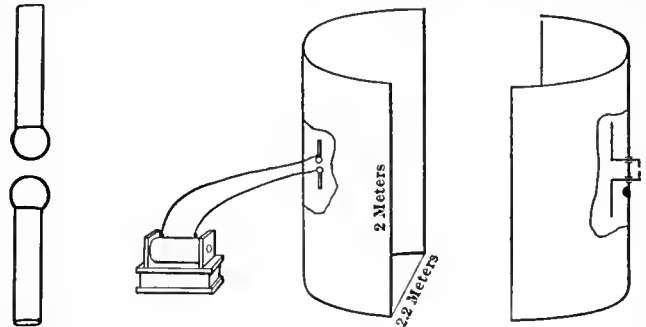

FIG. 28. Hertz's rec-tilinear oscillator.

FIG. 29. Hertz's cylindrical mirrors. Oscillator is at left; resonator, at right.

mirror, Hertz made the oscillator smaller, so that the length of the waves was less than one-tenth of those first discovered.

The form of oscillator used in these experiments is shown in Fig. 28. The two halves of the oscillator were cylindrical bodies 3 cm. in diameter, terminating in spheres 4 cm. in diameter. The total length of the oscillator was 26 cm., and the spark gap was usually about 3 mm.

For a receiving circuit, the circle of wire used in the previous experiments was replaced by a linear resonator, consisting of two straight pieces of wire, each 50 cm. long and 5 mm. in diameter, adjusted in a straight line so that their near ends were 5 cm. apart.

51

### THE HERTZ OSCILLATOR SYSTEM

A page from the text book (copyright by McGraw Hill Book Company), *Principles of Wireless Telegraphy*, by Prof. George W. Pierce of Harvard University. As early as 1888, Professor Hertz, at Bonn, Germany, performed experiments in directive radio transmission, using waves of about 66 centimeters. Some of the methods used by Professor Hertz are being revived at the present time, a curious instance of a technical "swing around the circle"

the older texts will see the similarity between this single wire to the original oscillators of Hertz. One half of the wire is the antenna, and the remainder is the counterpoise of the usual antenna installation.

The advantages of such an antenna are several. In the first place, it may be situated some distance from the transmitter proper with the result that all absorbing material may be removed from the field of the antenna. The single wire operated very near its fundamental frequency (wavelength), or at a harmonic of it will have a very high radiation resistance with the result that a given

amount of power put into it will be efficiently radiated into space. The only disadvantage discovered to date is that it is somewhat "tricky" to get into actual operation.

Amateurs who have experimented with such an antenna system are invited to write of their work to the Laboratory. Actual measurements of course are greatly to be desired.

### WHAT RELATION EXISTS BETWEEN POWER AND DISTANCE?

WITH regard to the relation between power and distance, the experiments already under way will reveal the questions the RADIO BROADCAST-Everyday experimenters would like to answer.

For several months the power used at 2 GY consisted of a battery powered 50-watt tube. About 120 watts input to the plate was used. Occasionally 1500 volts "raw" a. c. was placed on the plate and

at times the 1500 volts were rectified by means of an "S" tube rectifier.

The daylight range that could be expected from such an installation seemed to be from 800 to 1000 miles since stations in Florida, Ohio, and Illinois were worked without difficulty in broad daylight with considerable reliability.

When the 50 "watter" suddenly burned out, a 5-watt power tube was installed in its place and with about 40 watts input to the plate, the same range was obtained as with the larger tube. At night several communications were carried out with very low power. Notable among this work was that done with 4 JR in Gastonia, North Carolina, and 4 kw in Jacksonville, Florida. With the latter station communication was established when about 25 watts were used. Then the plate voltage was steadily reduced until finally only 100 volts were used with a plate current of 12 milliamperes. This represents a power input of 1.2 watts—and still 4 kw answered all of the questions that were sent to him from 2 GY. In other words, successful and reliable communication had been carried out with a power-mileage ratio of more than 800 miles per watt. This was not freak transmission nor was it due to excessive fading,

### Some Important Radio Questions to Be Answered

- What takes place along the high frequency bands?
- How far may one expect to carry on reliable communication in daylight, and at night, with a given amount of power and at a given frequency?
- Do signals actually "jump over" near-by stations, to reappear at some much greater distance?
- What is the relation between time of day and distance of transmission?
- What difference do the seasons make in short wave transmission and reception?
- Are some frequencies good at certain hours and not at others?

since the transmission lasted for nearly an hour, and followed similar work with 4 JR. While it is realized that it is one thing actually to exchange signals with a station and another to send and receive messages from it, it is believed that this "800 miles per watt" can be repeated or bettered. Recently 2 GY established communication and received several messages from the U. S. S. *Seattle* when she was leaving Tahiti in the South Seas. This is a distance of about 7000 miles and the communication was carried out on 97.5 watts. A still better record is the work with 7 uz, Seattle, Washington, two days in succession with a power of 5.4 watts. Station 2 GY has communicated with a number of amateurs who were using receiving tubes for transmitters.

suggested that a long message, copied perhaps from a magazine, be transmitted and checked back to see whether the communication was sufficiently dependable for the carrying out of traffic.

Amateurs who care to aid the Staff in the RADIO BROADCAST-Eveready experiments in their short wave, low-powered work are invited to write to the Laboratory of RADIO BROADCAST indicating in what manner they may best be able to help. Interesting experiments and experiences of amateur operators are always appreciated.

Amateurs who care to take part in the winter's tests from 2 GY are requested to communicate with this station, and interesting experiences of any operators will be appreciated at all times.

There is the recent performance of Canadian 9 CK on Vancouver Island, British Columbia, who worked for an hour with an Australian amateur when using a 5-volt receiving tube with 400 B battery volts on the plate.

The Staff would like to hear from amateurs who have records of successful low-powered transmissions especially when the time of day, distances covered, and power used are known. If communication is attained on very low power, it is

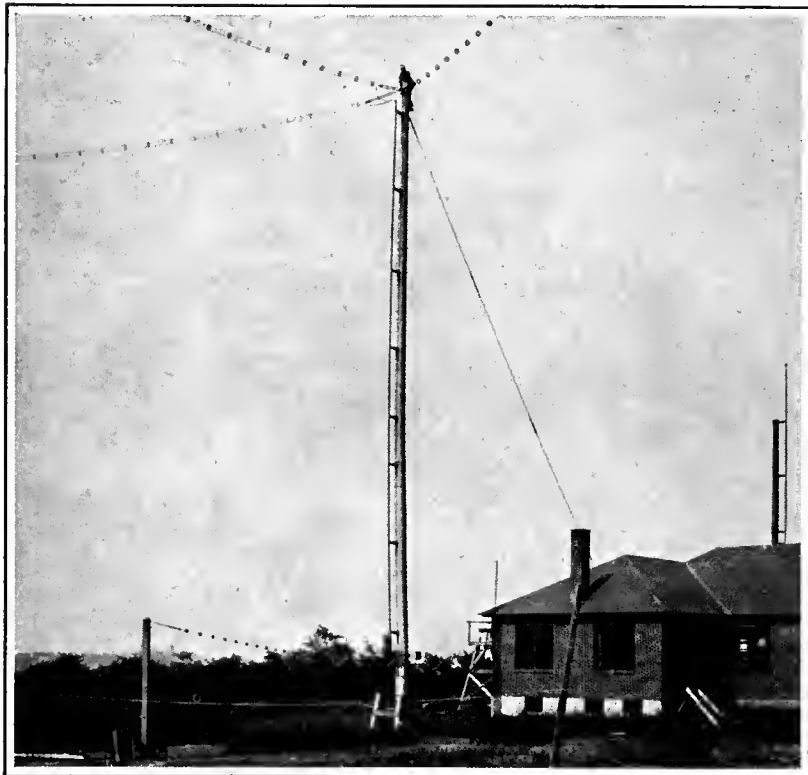

THE KDKA SHORT WAVE ANTENNA

Where the "driver" principle is employed to energize the antenna. One of the high frequency antennas can just be seen behind the station house at the right of the photograph. The driver system is in use on the longer antenna. Note the coupling coil at the base of the wooden mast. The wires suspended from the short pole are the counterpoise and take the place of a "ground." Signals radiated from this antenna have been received in Europe and Africa and are much more consistent than these sent out on the lower frequency



A TYPICAL AMATEUR SHORT WAVE OUTFIT

This one is owned by Mr. Leo Johnson, of New York City. His station call is 2 CTQ. Although many amateur stations are not famous for their scrupulously neat appearance, these experimenters have been able to reach out with their short wave signals to surprising distances. Amateur signals have been heard over a distance of 12,000 miles, which is as far in one direction as it is possible to transmit a radio signal

# An A. C. Receiver and Power Amplifier

Design and Assembly of a New High Quality Amplifier Operating from Alternating Current Together with a High-Efficiency Four-Tube Receiver with an A. C. Plate Supply

By JAMES MILLEN

IT HAS been suggested by a number of radio authorities that one of the essentials for good audio quality is high plate voltage. The most practical way in which to obtain this high plate voltage is from a current-tap operated from the a. c. electric light socket. Such a system also permits lighting the filament of the last tube with a. c., so that the use of a 5-watt power tube for this purpose is made possible.

Until now, the construction of a quality audio amplifier which would operate from the a. c. line has been almost impossible as many of the essential parts were unobtainable in the open market.

Realizing the advantages of an amplifier which would require neither A, B, or C batteries, and which at the same time would give amplification with an unusually high quality, RADIO BROADCAST has done much experimental work in order to determine the best design for the parts required.

Regardless of how fine an amplifier one has, if the loud speaker is poor, the received signal will probably sound no better, if as good, as from a poor amplifier connected to the same poor speaker. A number of good speakers are now obtainable on the radio market. Of particular merit are the cones.

In order to obtain quality output with a quality speaker, it is necessary that all the apparatus along the line be of high quality. The broadcasting station must produce high quality signals, the receiver must supply the power amplifier with high quality input and so on to the speaker.

In this paper will be described the con-

struction of a complete receiver operated mainly from the lamp socket. The receiver employs one stage of radio frequency amplification with a regenerative detector, and an audio-frequency amplifier embodying all the requirements for high quality.

The requirements are: 1. Use proper

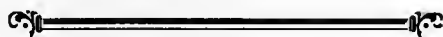

*R*ADIO constructors are watching with eagle eye to see what the fall season brings out in new design. The receiver and power amplifier described here so completely by Mr. Millen combines ideas far in the forefront of radio progress. The audio amplifier is a particularly interesting bit of design. Mr. Crom's article in RADIO BROADCAST for October, 1925, laid down some theories of the audio amplifier and Mr. Millen's design puts his suggestion into definite form. And—perhaps most important of all—the plate supply of the entire receiver is drawn from alternating current; and in addition, the filament of the power amplifier is heated by A.C. The quality of the received signal, using this set-up with a cone type loud speaker, is almost beyond reproach.—THE EDITOR.



value of C battery for the signal voltage at the grid of each tube. 2. Use plate voltage which corresponds to this C voltage. 3. Use transformers with proper primary inductances. 4. Use a. f. by-pass condensers. 5. Cable filament and plate leads. 6. Burn tubes so as to secure proper electron emission. 7. Employ an output device to keep the d. c. component

of the space current on the last tube from flowing through the loud speaker.

Since many of the readers of RADIO BROADCAST already have receivers of various kinds which they do not care to change, the construction of a power amplifier and power supply unit which will enable them to improve their present outfit will also be described.

The quality of output that will be obtained from the power amplifier does not materially differ from that obtained from a good resistance-coupled amplifier with a low impedance tube (so as better to match impedance of the cone type speakers) in the last stage. The main difference is that one power stage will do what three resistance stages will, and at the same time eliminate the batteries.

As the two tubes in a push pull amplifier are operated 180° out of phase, distortion due to insufficient C and B voltage cancels out, and good quality is thus obtained with low voltage.

THE CONSTRUCTION OF A KNOCKOUT SET WITH QUALITY POWER AUDIO AMPLIFICATION

THE set proper employs the standard Roberts Knockout circuit. The writer made a number of experimental models and in some, reflexed the first audio through the radio tube. The sets shown in Figs. 1, 2, and 3 are not reflexed, and, though the elimination of the reflex requires an additional tube, such a set will give more volume without danger of overloading the first audio tube, which may happen with the reflex model on loud signals.

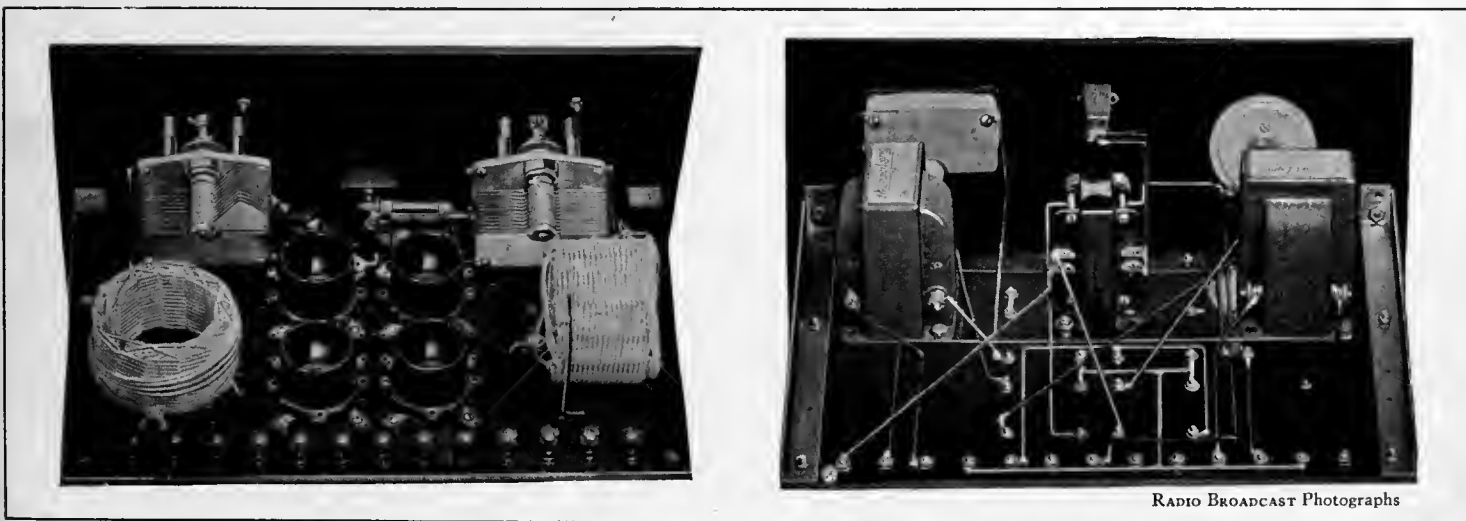

FIGS. 1 AND 2

Fig. 1 (Top of sub-base views). The receiving set with power amplifier. The a. c. power supply unit is contained in a separate cabinet. Fig. 2 (Under sub-base) Note the output transformer, which serves the double purpose of keeping the d.c. component of the plate current out of the loud speaker and making possible the use of a low impedance speaker

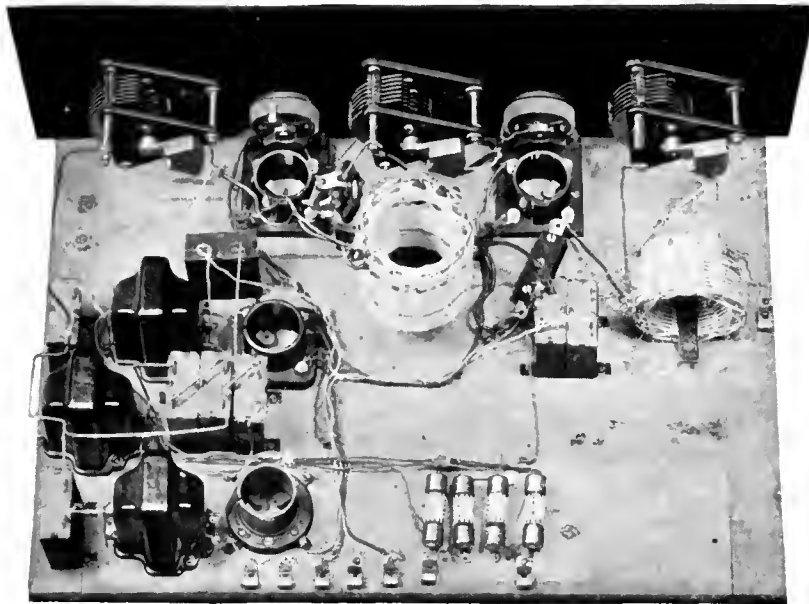

RADIO BROADCAST Photograph

FIG. 3

An experimental receiver with a high quality audio amplifier. Audio frequency by-pass condensers, an output transformer, and high C and B voltages are employed. The power supply unit is contained in a separate cabinet, but in order to reduce the number of leads between the power unit and the set, the voltage dividing resistors are mounted in the set as shown

The only batteries required with this set are one small 4½-volt C battery and three dry cells.

The first three tubes may be three, one and a half-, or five-volt. Although the amplification obtained with the smaller tubes is somewhat less than that obtainable with storage battery tubes, there are several advantages to be gained by the use of the

small tubes. *First*, the maximum output obtained from the small tubes will not be great enough to overload the power tube and thus cause it to distort. In other words, in order not to overload the power tube, the maximum signal voltage applied to the grid of this tube must not be greater than the C battery voltage. In this amplifier, therefore, a signal voltage in excess

of about 22 to 24 volts (with a UV-202 or 27-28 volts with UX-210) will very likely cause distortion. As most of the input transformers, which are recommended for use with the last stage in this amplifier, have a ratio of 2:1, the output signal voltage from the first audio stage should not exceed 12 volts. Measurements made in the RADIO BROADCAST Laboratory showed that output peak signal voltages (measured with a vacuum tube voltmeter) obtained from the first audio tube using a UV-199 were never likely to exceed the 12-volt limit.

Should overloading take place in your amplifier, it will readily be detected by the plate circuit milliammeter needle movement as described by Mr. Crom in his article in the October RADIO BROADCAST. In order to remedy the trouble, connect a variable resistance, such as Bradleyohm No. 10, a Clarostat, Royalty No. B, or similar resistance across the secondary of the first audio transformer and adjust it until the distortion is eliminated. The effect of this resistance is to reduce the signal voltage which will be applied to the grid of the last tube and incidentally that which will be applied to the grid of the first tube. If this resistance were connected across the secondary of the second transformer, it would accomplish the same results, as far as the power tube is concerned, but it would not have eased the load on the first audio frequency tube, and, as this amplifier has been designed so that overloading (when three volt tubes are used) will start in the first stage slightly before (if at all) it will in the

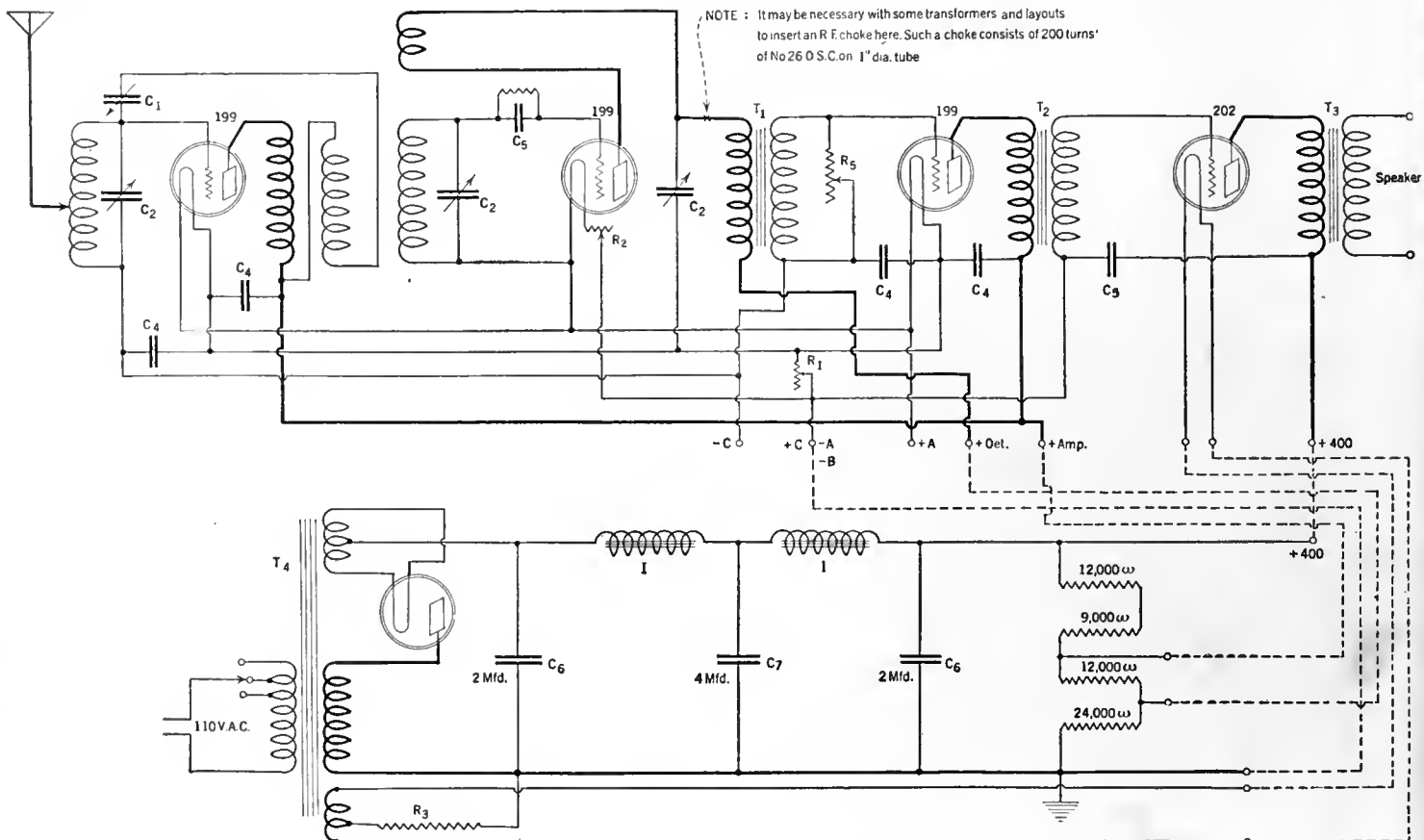

FIG. 4

The circuit diagram of the complete receiver

power stage, the proper way is to reduce the load on all tubes by means of a resistance across the first transformer secondary. Such a variable resistance also serves as an excellent volume control.

Instead of the variable tickler to control the regenerative detector, frequently in a receiver employing a circuit of this sort a fixed tickler and variable by-pass condenser are employed. With this arrangement, the tuning of the detector condenser is not affected by the regeneration control.

Another satisfactory method of controlling regeneration when a fixed tickler is employed, is by means of a variable resistance connected across the tickler coil.

The coils may be the standard coils made for the Roberts circuit, such as the Supercoils, Sickles diamond weave, etc., or they may be home made. The two tuning condensers have a maximum capacity of .0005 mfd., and with the coils described above cover a frequency range of from 1363 to 545 kilocycles (220-550 meters). A rheostat is provided for the detector and another for the two amplifier (r. f. and a. f.) tubes.

If three-volt tubes are to be used (and their use is highly recommended) it will be better to use them in sockets designed for them rather than using adapters in large sockets, as shown in the photographs.

All filament and plate leads are "cabled." Furthermore, large by-pass condensers are provided in all the amplifier circuits. As the construction, neutralization, and

operation of sets with neutralized r. f. amplifiers and regenerative detectors has been dealt with so many times in previous issues of RADIO BROADCAST, the subject will not be further discussed here. Those who are not already familiar with circuits of this type are referred to the article by Mr. Keith Henney in the April, 1925, RADIO BROADCAST or to any of the articles by Mr. J. B. Brennan.

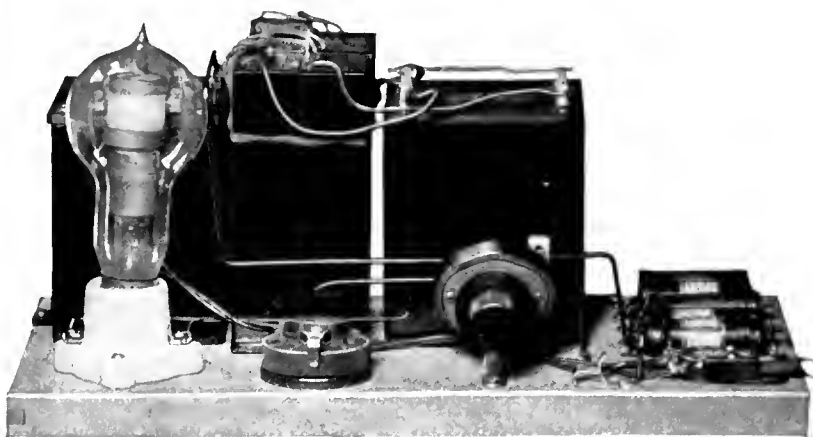

RADIO BROADCAST Photograph

FIG. 5

A power supply unit employing an S tube as a rectifier. The transformer and the chokes are contained in separate iron boxes with bakelite panels

THE POWER AMPLIFIER

THE necessary components of the power amplifier are input transformer, power tube, by-pass condensers, and output transformer.

The input transformers may be any high-

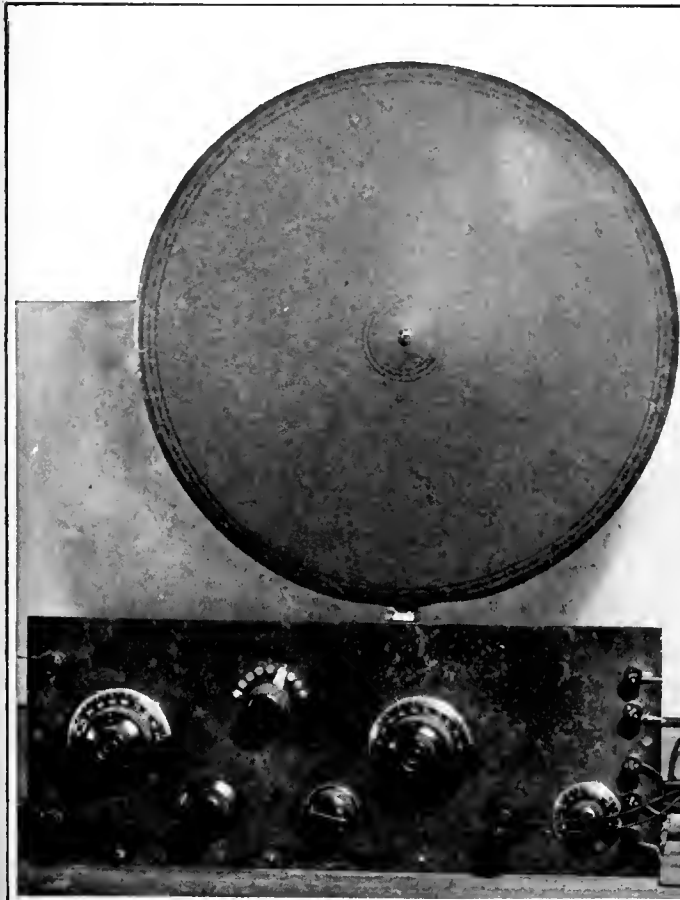
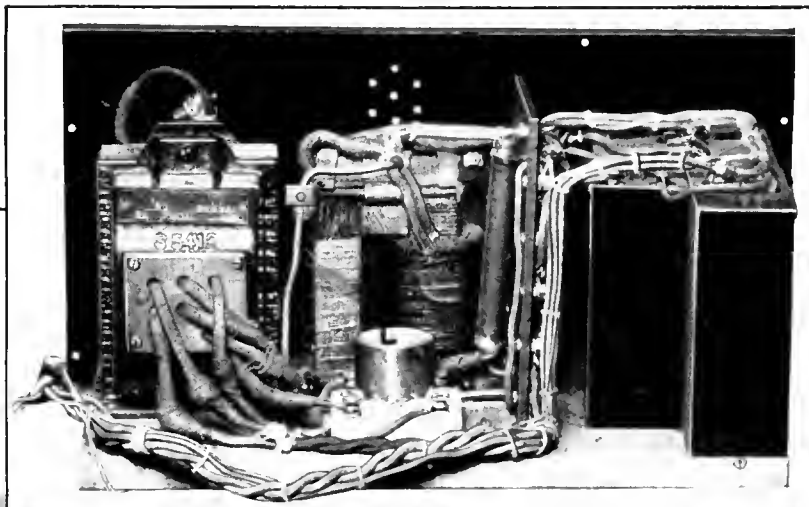

FIGS. 6 AND 7

RADIO BROADCAST Photograph

Interior of the power supply unit shown in Fig. 7 is in the insert at the upper right. The large photograph shows an experimental layout with the high-quality amplifier and power supply unit connected to a two-tube Knockout receiver. An impedance-capacity output device is employed in the amplifier

grade low ratio audio transformer. Those successfully tried out by the writer in his amplifier were Rauland Lyric, Amertran ( $3\frac{1}{2}:1$ ), and General Radio No.285A. They should have a turn ratio of from 2 to  $3\frac{1}{2}$  to 1, not higher.

The power tube may be a UV-202 or a UX-210.

The UX-210 and the UV-202 operate from the transformers without rheostats. The UV-202 is most easily obtained by writing direct to Amateur Sales Division Radio Corporation of America, 233 Broadway, New York. It sells for \$3.50. The UX-210 lists at \$9.00 and is obtained from any Radio Corporation or Cunningham dealer.

Several of the independent tube manufacturers are now making power tubes with 5-volt filaments. Double rheostats, as shown in Fig. 13, will have to be used with them.

The grid return condenser may be any of the paper condensers. About one mfd. is a satisfactory size. The plate by-pass condenser, however, must be capable of continuously withstanding the full plate voltage (about 400 volts). Most of the small paper condensers, such as the No. 765 Dubilier, will not stand up when put to this use. The Dubilier No. 769, W. E., Tobe, Acme No. 750 volt, or four of the lower voltage condensers connected in a series-parallel arrangement will be necessary.

The output device serves two purposes. The first is that it keeps the direct current from going through the speaker, and, second, it "matches" impedances. Thus, if a transformer is used the primary must have the proper impedance to work with the power tube and the secondary must be designed to fit the speaker. The plate impedance of the power tubes available for use in the set is the same. The impedances of some of the high-grade loud speakers, however, are quite different, and they may be grouped into two classes, high and low impedance. The Western Electric cone is a low impedance speaker, whereas the Farrand-Godley has a high

impedance. Therefore, in purchasing an output transformer, the type of speaker that it is to be used with must be kept in mind.

Some constructors may have a pair of push-pull transformers on hand. An output push-pull transformer can be used as an output transformer for the amplifier. The mid tap on the primary should be disregarded and the plate of the power tube connected to one of the terminals marked P (or plate) and the plus B to the other terminal marked P (or plate). The loud speaker (which, for most push-pull transformers, excepting the Western Electric, should be of fairly high impedance) is connected to the "output" or "speaker" posts.

There is another method of connecting the loud speaker which does not require a transformer. It is illustrated in Fig. 12, and employed in the amplifier shown in Fig. 6. The "Amerchoke" and the Thor-darson Autoformer make ideal impedances for this use.

When these parts have been wired up as shown in Figs. 11 and 12 the receiver itself is complete. There then remains the construction of the power unit for operating it from the house current.

#### CONSTRUCTION OF POWER UNIT

THE power unit is merely an "overgrown" B-substitute with an additional transformer winding. The rectifying device should be either a thermionic or an S tube. Both have been very successfully employed. The parts required for the construction of the power unit are transformer, tube and socket, chokes, condensers, and resistance units.

Transformers suitable for this purpose are the General Radio, Amertran, Acme, Dongan, and Jefferson. A suitable transformer must have at least one 7.5-volt secondary (with mid tap), and at least one 450- to 500-volt winding.

The transformer must also have a 110-volt primary, or better yet, have taps to take care of variations in line voltage from 105 to 120. If a thermionic tube (Kenotron, UV-202, UX-210, UX-216B) is to be employed

as a rectifier, then two 7.5-volt windings will be required. An S tube has no filament and, consequently, requires no filament heating winding.

Either double- or single-wave rectification may be employed. Both give excellent results, but the double-wave rectifier has the advantage of not requiring quite as elaborate a filter system as the single wave. However, for double wave rectification two rectifying tubes are required and two high-voltage transformer secondaries.

The power supply units described in this paper are of the single-wave rectification type, requiring but one rectifier tube and one high-voltage transformer secondary. The transformer should be rated at about 50 watts.

If a power tube (UV-202, UX-210, etc.) is employed as the rectifier, it is highly important that the grid and plate be connected together. The Kenotron, UV-216, which is the same as a UV-202 but designed only for rectifying and, therefore, having no grid, may be obtained from the Amateur Sales Division, Radio Corporation of America, 233 Broadway, New York. The UX-216 B, which is the rectifier patterned after the UX-210, is carried by all R. C. A. and Cunningham dealers.

Two chokes of about 50 henries each are required for the filter system. They must be designed for a total current of about 30 milliamperes and have as low a d. c. resistance as is economically practical. Such chokes may be obtained from Amertran, Jefferson, Dongan, Molliformer, Apco, or General Radio Companies, or they may be made at home as described by the writer in the June and October issues of RADIO BROADCAST.

The filter condensers must be capable of continuously withstanding the high voltage. There is generally quite a difference between "flash" voltage and "Maximum working" d. c. voltage. It is this last rating that is important and it must be at least 500 and preferably 750 volts in order to be satisfactory for use in the filter. Condensers which meet this requirement are manufactured by Dubilier (No. 769)

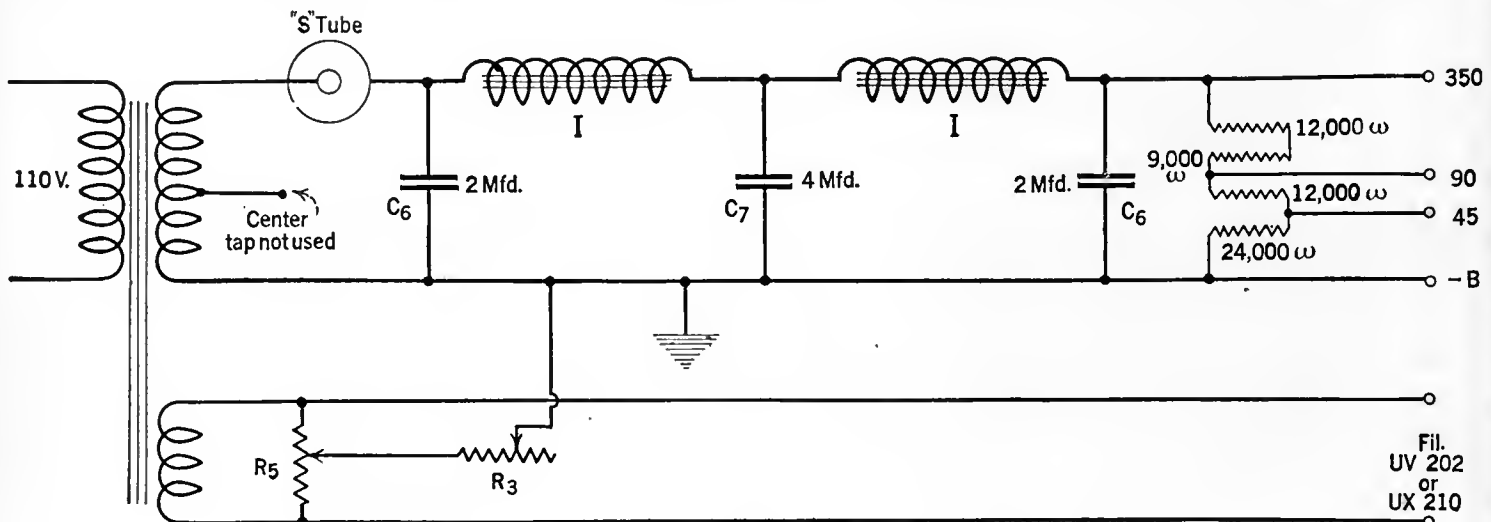

FIG. 8

The circuit diagram of the power supply unit shown in Fig. 5



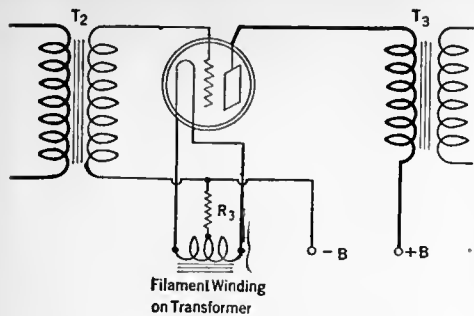

FIG. 9

The C bias is obtained by means of the voltage drop across the resistance  $R_3$

but not No. 765), Acme, Tobe Dutschmann and Western Electric. W. E. condensers may be obtained from C. E. Jacobs, 2802 N. Kedzie Ave., Chicago.

Several resistance units are required in order to secure the proper B voltages for

the detector, r. f. tube, and first a. f. tube as well as the negative C voltage for the grid of the power tube. The values and connections for these units are indicated in Figs. 4 and 8. They may be of Ward-Leonard, Crescent, or Allen-Bradley make.

In place of the fixed 1250-ohm unit employed for obtaining the proper negative bias on the power tube, a C battery of about 22½ volts (for uv-202 or 28 volts for ux-210) may be employed. The voltage should in that case be adjusted for best results as indicated by the milliammeter tests outlined by Mr. Crom in RADIO BROADCAST for October.

Another way of varying the negative bias to the power tube which does not require a separate C battery, is the use of a variable resistance such as the Clarostat or Electrad Royal. We believe this to be the best method, as the proper C bias may be obtained by varying the resistance while observing the plate milliammeter.

The power supply unit is generally most conveniently located under the table on which the set is placed. The several leads from the power unit to the set should be "bundled" together into a cable; one of the standard battery cables such as the Jones or Belden may be used for the purpose. The 110-volt a. c. cord is thus kept a fair distance away from the set proper. This is of slightly more importance in reflexed sets.

If the power unit is placed in a cabinet, such as the one in Fig. 7, it is important to provide proper ventilation so that the heat generated by the rectifier tube will be dissipated. The plate milliammeter (0-50 m. a.) may also be conveniently located if de-

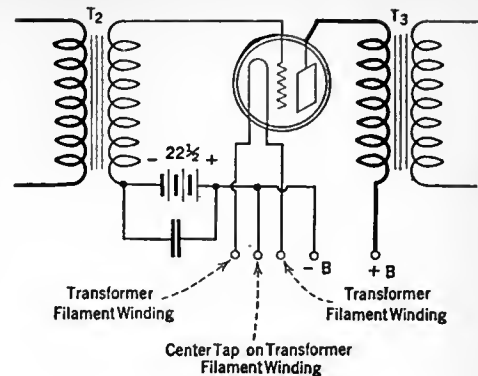

FIG. 10

A C battery may be employed with the power amplifier, if desired, instead of obtaining the grid bias from the power supply unit

sired, on the panel of the power supply unit. This is also a good place for the 110-volt switch.

OPERATION OF THE SET

AS THE operation and neutralization of receivers employing this circuit have been covered in a number of previous articles in RADIO BROADCAST, they will not be taken up again.

The adjustment of the power amplifier, however, will no doubt present some new problems to many of the readers. The filaments of both the power amplifier and the rectifier tubes must be operated at exactly the right voltage. This is particularly true of the uv-202 when used as an amplifier. If the filament voltage is too low, it will cause a great deal of distortion. On the other hand, if it is too high, the life of the tube will be materially shortened. The filament voltage of the 210 is not as critical as the 202. Ordinarily the only way to adjust the filament voltage properly is with an a. c. voltmeter, but the use of such an instrument will not be necessary with the transformers recommended in this article, as the voltage supplied is just right, providing sufficiently heavy wire, such as No. 16 or No. 18 flexible lamp cord or the equivalent solid wire is employed in connecting the tube socket to the filament winding on the transformer. Furthermore, the length of the filament line should preferably not exceed three feet. It is also highly important, especially with the uv-202, that the tube makes very good contact in the socket.

When a 6-volt tube is to be used, or if the Acme 75-watt c. w. transformer (which has a 10 instead of 7.5 volt filament winding) is used with either a 6- or 7½-volt tube, it is necessary to employ two rheostats, one in each filament lead; they must both be adjusted simultaneously in order that the resistance in each filament lead will be about the same. See Fig. 130.

When rheostats are employed to adjust the

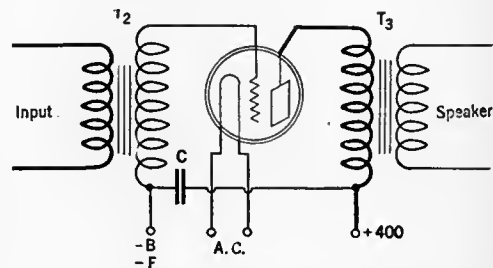

FIG. 11

The circuit diagram of the power amplifier using an output transformer

COST OF MATERIAL

Used in the Complete Receiver

	MAXIMUM PRICE
<i>The Receiver</i>	
Panel	
Base Board	
3 General Radio, Silver, Hammarlund, or other good condensers, max. cap. 500 mmfd. . . . .	\$15.00
3 Dials	
1 Set Robert Coils	8.00
1 A. F. Transformer $T_1$ (1 General Radio, No. 285, \$6; 1 Amertran No. AF 6, \$7).	
1 Neutralizing Condenser $C_1$	
3 Sockets	
2 Rheostats $R_1$ and $R_2$	
1 Volume Control $R_3$ (Clarostat, \$2.25; Bradleyohm No. 10, \$2.00; Royalty (Electrad) No. B, \$1.50)	
1 Grid Condenser and Leak $C_2$	
4 1 mfd. By-pass Condensers $C_4$ . . . . .	5.00
<i>The Power Amplifier</i>	
Input Transformer $T_2$ (General Radio, No. 285-A, \$6; Amertran, No. A F 7, \$7).	
Output Device	
General Radio Transformer No. 367, $T_3$ (for W. E. Cone)	7.00
Output push-pull transformer (for high Impedance Speakers) or	
Impedance-Output (for either high or low Impedance Speakers), Thordarson Auto-former, I, \$5; Amer-choke No. 154, I, \$6; 1-4 mfd. condenser (or total of 4 mfd., \$5).	
Socket	
1 Mfd. By-pass Condenser $C_3$ (Tobe Deutschmann, \$1.25; Dubilier No. 678, \$1.75).	
<i>Power Supply Unit</i>	
Power Transformer $T_4$ (Amertran No. PF 45, \$12; General Radio No. 365 (for "S" tube), \$12; General Radio No. 273M (Additional filament winding for rectifier tube,) \$12).	
Chokes 1, (2 Amer-chokes No. 854 at \$6, \$12; 2 Molliformers at \$6, \$12; 2 apco chokes at \$6, \$12; 1 General Radio double choke No. 366, \$12).	
Filter Condensers (500 volt) $C_5$ , $C_6$ , (4 Dubilier No. 764, \$3.50, \$14; 4 Tobe Deutschmann No. 709 2 mfd., \$1.75, \$7; 4 W. E. 2 mfd., \$1.65, \$6.60).	
Socket	
Milliammeter (0.25 m.a.), (Jewel, Weston, \$8.)	
Jones Cable (or Belden)	1.00
Resistance Units (Bradley Units, 2 12,000 ohms; 1 10,000 ohms; 1 25,000 ohms, \$.75 each; Ward Leonard H S Units; Crescent, 2 12,000 ohms; 1 9,000 ohms; 1 24,000 ohms, \$2.50 each (All special) \$10).	
Grid Bias Resistance $R_3$ (Ward Leonard (fixed) (L S 1250), \$.85; Clarostat, \$2.25; Royalty, \$1.50).	
<i>Tubes</i>	
UX 210 . . . . .	9.00
UV 202 . . . . .	3.50
KENOTRON . . . . .	3.00
RECTRON 216B . . . . .	7.50
Speaker	
Switches, Screws, Lamp Cord and Plug, Box or Base Board for Power Supply Unit.	
The completed receiver, including tubes but not speaker, will cost approximately \$100.	

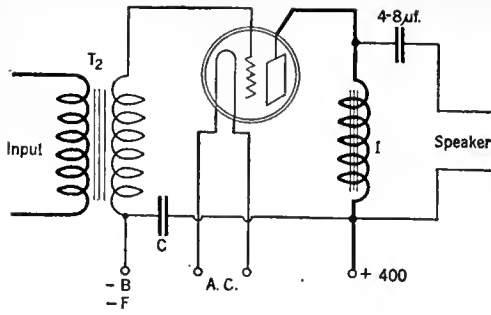

FIG. 12

The circuit diagram of the power amplifier using an impedance-capacity output device

filament voltage, it is strongly recommended that a good a. c. voltmeter be used as an aid to securing the proper adjustment. To dispense with the use of such an instrument is not economy. The life of a tube is very materially reduced when operated at higher than rated voltages.

Rheostats for this use must be capable of carrying about  $2\frac{1}{2}$  amperes. The resistance may be one or two ohms. Such rheostats are manufactured by Amsco, Acme, Fada, Pacent, and General Radio. If a variable resistance is employed for obtaining the grid bias, it should be adjusted so that the millimeter in the plate circuit of the power tube remains reasonably still when receiving signals of varying intensity.

The plate current drawn by the power tube should not exceed about 20 mils. Seventeen or eighteen is about correct for most 202's and about 20 for the 210's.

If an Acme c. w. transformer is employed, it

will be necessary to use an S tube as the rectifier; there being no rectifier filament winding provided on this transformer (the S tube has no filament). The No. 5000 S tube is best suited for this purpose, although the No. 4000 may be employed if desired. The No. 5000 only costs \$6.50, whereas the other costs \$10.00. S tubes are best obtained direct from the factory.

The voltage of one half of the split high voltage secondary on the Acme transformer is too low and the entire voltage is too high. Therefore, it is necessary to use the entire

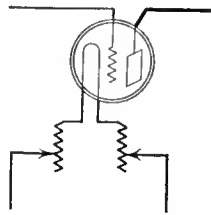

FIG. 13

The way in which rheostats must be connected when a 6-volt tube is to be operated from a higher voltage transformer winding

secondary and connect a resistance of from 5000 to 6000 ohms in series with the plus lead as shown in Fig. 14. The drop in voltage across this resistance results in the proper output voltage.

### A POWER AMPLIFIER FOR YOUR RECEIVER

FIGURES 7, 11, 12, show the power amplifier, similar to the one used in the complete set, mounted on a small board by itself. The same power unit as is employed to operate the complete set (Figs. 1, 2, 3) is used to operate this amplifier as

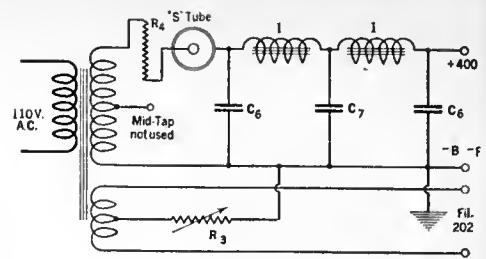

FIG. 14

Circuit diagram showing proper connections for employing a standard Acme c. w. transformer

well as supply the B voltages to the small outfit to which it is connected. Such a combination possesses most of the advantages of the complete set (for it is practically the same thing) and at the same time makes it unnecessary to discard the small set.

In most cases it will be necessary to connect a variable resistance such as a Bradleyohm No. 10, Royalty B, or Clorostat across the secondary of the reflex transformer. It is also necessary to keep the a. c. lines as far as possible from the reflex amplifier in order that a. c. "hum" will not be picked by induction, and, most important of all, ground the negative B.

Such a combination as shown in Fig. 6 results in a considerable "gain" in volume without the loss of any of the high quality for which the Roberts Knockout receiver is so well known.

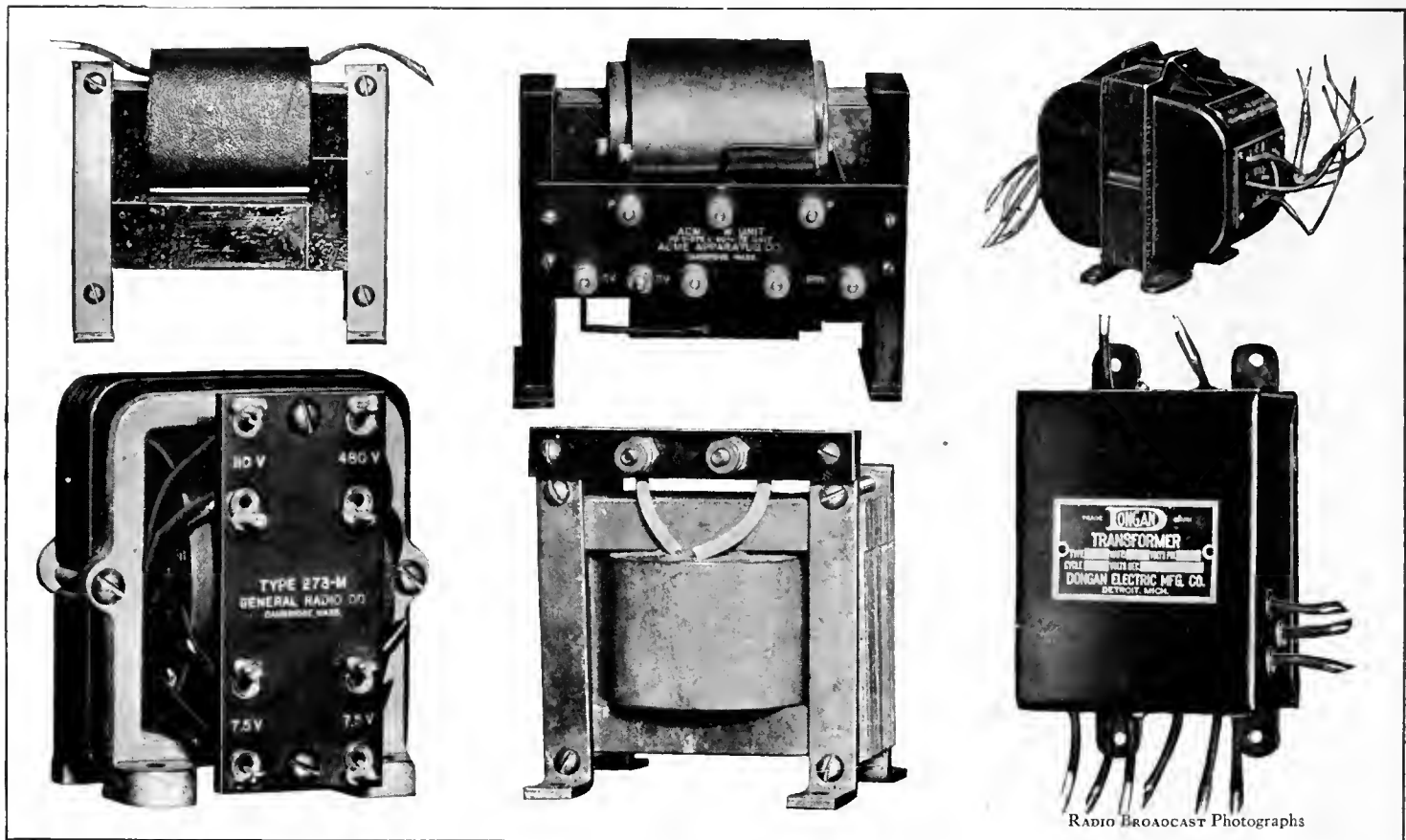

FIG. 15

There are a number of excellent transformers and chokes now obtainable in the radio market. Some which have been successfully used, but which are not shown in the other photographs, are grouped here

# When the Doctor Came to the Farallones

## —By Radio

How Broadcasting Has Brought the Advantages of City Life to a Barren Pacific Island

By LEWIS N. WAITE

**T**HE following episode, a little drama of modern science, has an interest which reaches far beyond the small group of persons it concerns, and it is for this reason that it is told.

The incident occurred some few months ago on the lonely Farallone Islands, which are situated off the mid-northern coast of California. A young child belonging to one of the half-a-dozen families then living on the island was taken seriously ill. There was no physician available on the Farallones, none nearer than San Francisco, twenty-five miles distant over the ocean. The condition of the child indicated that its illness was no ordinary one, and the services of a skilled physician were urgently required.

To carry the child to San Francisco or to summon a specialist to the Island seemed the only possible things to do, but both these plans involved hours of delay. Those at the bedside realized that such delay might prove costly or even fatal. It was at this point that science stepped in with an alternative plan.

On the Island, the Government maintains, together with other devices for the assistance of navigation, a radio signal station, and so once again it fell to the lot of wireless to serve humanity in an hour of distress. Within a few moments after it had been decided to make wireless serve as a physician, the operator on duty was in touch with San Francisco and the San Francisco radio office was telephoning to locate a specialist in children's diseases. Less than half an hour passed before the specialist and the father of the child were in direct communication, aided by the long arm of the radio telegraph. Then followed a long series of questions and answers, while the doctor, thirty miles away, familiarized himself with the case, made his diagnosis, and, finally, prescribed a course of treatment. It was an illness that required immediate attention along a particular line; a delay of a dozen hours might have proved fatal.

### THE RADIO DOCTOR SAVES LIVES

**T**HE instructions given over the radio were scrupulously followed in the sick room, and the next day reports from the Island were so encouraging that the doctor pronounced his radio patient out of danger. In a week, the child's recovery was complete.

This incident serves to illustrate in a

striking way how modern inventiveness is changing very materially the lives of those who live in remote and inaccessible places. New methods of communication are drawing scattered communities closer together, and, perhaps, gradually fusing the thought and interests of the country into a homogeneous whole.

More than in most communities, radio has influenced the lives of those on the Farallone Islands. Only here, and in other similarly isolated colonies, can the change be truly called revolutionary.



FARALLONE LIGHT

Whose beam at night is the first suggestion to sea travelers bound for San Francisco that they are approaching the western coast of the United States. Recently, radio brought aid to a child on the coast who was seriously ill. A physician in San Francisco was reached through the Naval radio station and gave a diagnosis and suggestion for treatment which cured the child. Broadcasting has brought the Islanders close to the entire western half of the country and has altered the monotony of their lonely existence

Where formerly the two or three dozen isolated citizens who live on the Islands derived their sole contact with the outer world from the infrequent visits of government supply boats, and their own still less frequent visits to the mainland, the broadcasting stations now have placed at their disposal a variety of entertainment that must make their lives, in comparison with their former existence, almost unbelievably pleasurable. All of the Pacific Coast and many of the inland broadcasting stations are within range of the Farallone receiving sets. Frequently now, of an evening, these people dance to the music of the jazziest of metropolitan orchestras, or listen to a lecture or a play. They hear news items that otherwise would not have reached them until after the arrival of the government tug, perhaps days later. The radio has at last beaten down the barrier of the Pacific and made these lowly inhabitants of the Farallones sharers in the bustle and activity of life on the mainland.

### THE ISLAND STAGE WHERE RADIO PLAYS

**T**HE Farallones are as bleak and rugged a group of islands as may be found anywhere in the world. There is nothing about their steep cliffs and rocky crags, and their inhospitable, reef-fringed shores, to attract settlers. The fact that they are inhabited at all is due to an accident of location. For the Islands lie due west of San Francisco Bay, twenty-five miles from the Golden Gate.

Standing thus directly in the path of steamers plying to and from the Orient, the Farallones were so serious a menace to navigation that the Government was forced many years ago to establish a lighthouse there. The lighthouse, one of the most powerful and important on the Pacific Coast, is perched on top of one of the rocky summits, 350 feet above the sea. To many hundreds of travelers from the Orient, this flashing light, visible for 26 miles, is the first welcoming signal from America, the first intimation of land after weeks at sea.

Other means of safe-guarding shipping, supplementing the lighthouse, were presently established on the Farallones. For use during foggy weather—frequent in this district during certain seasons—a powerful siren was installed, its intermittent blast, audible for miles, announcing that danger of running on the rocks was imminent for any ship that might be groping about in



### THE FARALLONES

Are lonely barren islands, about twenty-five miles due west of San Francisco Bay. It is the fashion to speak of radio revolutionizing domestic life because of the new and varied entertainment it introduced into the home. That is rarely true, but in isolated spots such as these islands, broadcasting does bring many of the municipal advantages to the door step of isolated people

the vicinity. More recently, as the science of marine signalling has developed, other safety devices have been added, among them submarine bells. The radio compass signal station, installed for the purpose of assisting ships at sea in checking their positions, was one of the earliest additions to the Islands' safety equipment.

With the installation of these various devices, the population of the Islands, which at first consisted only of the lighthouse keepers, has steadily increased. To-day the government employees and their families alone make up a considerable community. They are adequately housed and cared for with materials brought from the mainland. Naturally, reserve stores of supplies are maintained on the Islands, and these supplies are carefully checked and frequently replenished.

The normal, matter-of-fact community life which the inhabitants lead is not notably different from that of little settlements elsewhere. But an example of the ingenuity employed in overcoming difficulties that ordinarily would be considered insurmountable is shown by the way in which the inhabitants of the Islands obtain their water supply. The Islands have no natural supply of fresh water. The task of shipping water from the mainland was impracticable, both because of the large quantity required and the difficulty of transporting it from the vessel to the Islands, which difficulty is due to the currents and reefs that make the landing of supplies a difficult feat.

The solution to the problem was

that the Islands, while they contain no sub-surface water, have a very heavy rainfall, which, it was decided, should be gathered and conserved. The top of the largest building of the Islands was made to serve as a shield in which the water was collected and then drained off into storage tanks. By an admirable combination of pleasure and utility, the inhabitants use the concrete roof of this building during dry weather for a tennis court.

NOW THE FINGER OF ATTENTION POINTS

**N**ORMALLY, the Farallones receive but little attention from the outside world. The inhabitants go about year after year performing their monotonous task of issuing warnings to shipping and keeping their signals in order, and they neither expect nor want attention from those who live on the mainland. But occasionally something happens that brings the Islands before the public.

Recently the Farallones figured prominently in the newspapers of the Pacific Coast, and in a very curious way. A Coast Guard cutter, cruising about in search of rum-runners, sighted such a vessel off the Farallones and, after a chase, succeeded in capturing it and bringing it into San Francisco Bay. The steamer and its cargo, valued at several hundred thousand

dollars, was held by the prohibition authorities and confiscation proceedings were begun.

At this point attorneys representing the owners of the vessel put forward a novel defense. They advanced the argument that the seizure was illegal because the vessel, at the time of its capture, was more than twelve miles from United States territory—the maximum distance at which arrest for violation of this law can take place. This statement the prosecution emphatically denied and proceeded to prove that the capture was made only a mile or two off the Farallones. The attorneys for the defendants then made the statement that the Farallones, never having been formally annexed to the United States, were not in reality a part of this country, and that the arrest was therefore an illegal one.

So surprising a charge naturally created widespread interest and led to a careful search in musty, long-forgotten records. Whether or not these lonely rocky islands will be proved to be ownerless has not yet been determined. But in the meantime the little group of lighthouse keepers and signal station operators go unconcerned about their tasks, conducting quietly the affairs of the community in which they live, and gathering about their radio sets in the evening to listen to the grand opera or the jazz orchestras of the outside world.

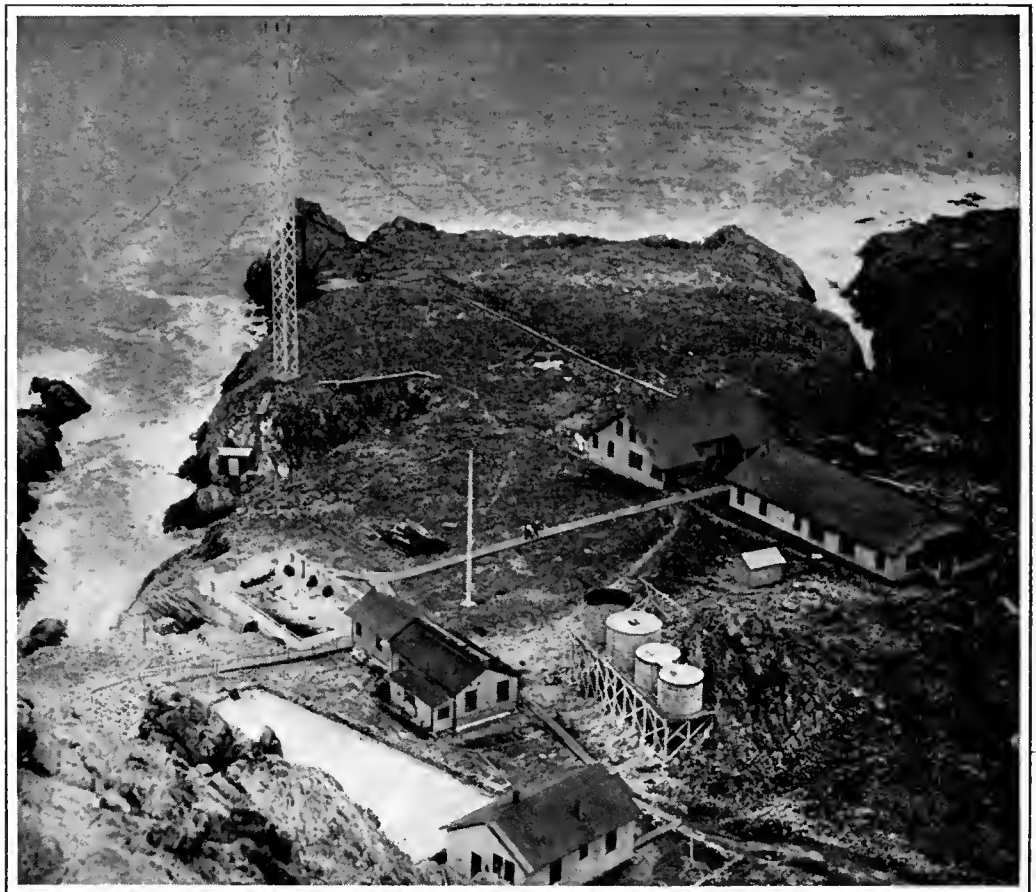

SOUTH ISLAND

In the Farallone group, off the California coast, showing the combination watershed and tennis court in the lower left. The radio tower is part of the Navy radio installation which forms the sole link to the mainland. The Farallones are about twenty-five miles off the coast, almost opposite San Francisco, and are barren and storm-swept. The population is very small

# 3176 Trained Factory Representatives

## Are Now Entitled to Wear That Button

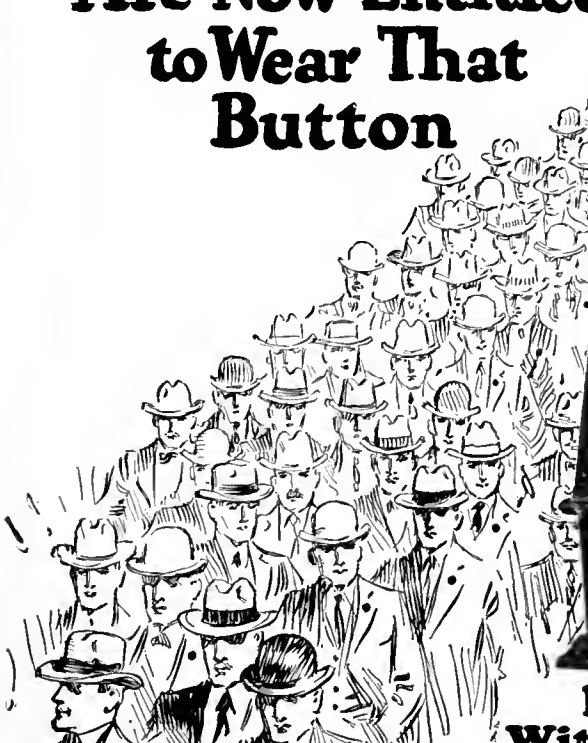

### Radio With Service

### Ozarka Offers Real Opportunities for Sales Representatives

**O**ZARKA radio instruments are demonstrated, sold, installed and serviced by direct factory representatives only. These men have been thoroughly trained by our own engineers who designed and perfected the Ozarka.

It is not exaggerating to state that hundreds of thousands of homes are waiting for "Radio with Service."

The success of any radio instrument, like the automobile, depends on the quality of service rendered.

In other words they are waiting for the Ozarka trained man. Already we have 3176 such representatives, and the field is barely scratched. Ozarka training is very thorough, intensely interesting, and quickly absorbed through study in spare time, by any man who is mechanically inclined.

No matter how perfectly any radio instrument leaves the factory, little things may sometimes go wrong. You've no doubt learned, by costly experience, that the ordinary handy man cannot properly service your automobile. The same is true of Radio. Troubles are generally caused by very little things which are exasperating to the owner, but are quickly corrected by the man who is trained on that instrument.

**OZARKA  
Four Tube  
Radio  
as Low as  
\$19<sup>50</sup>**

### 12 FREE Selling Lessons

Three other qualifications are necessary: the desire to better your condition, willingness to work, and at least a little capital.

You may not think that you possess the necessary selling ability, but with the qualifications just mentioned, plus Ozarka training, you can and will talk convincingly of what Ozarka will do — and you can set up the Ozarka instrument in the approved manner that insures satisfaction.

Today 3176 factory representatives are authorized to wear the Ozarka button. These men know Ozarka perfectly; more are now being trained; soon there'll be one in every town.

### FREE BOOK!

Without obligation to you, the Ozarka representative will set up an Ozarka in your home on trial. He won't claim that it is better than others. All he asks is the opportunity of letting the Ozarka do its own selling. With your own operating you must satisfy yourself that it has no equal for volume, tone, distance and ease of operation.

The Ozarka plan is fully described in a large illustrated book. A copy will be sent to men who are willing to tell us fully about themselves. Unlike any book you have ever read, the Ozarka book is a true story of life, of men, of why they fail, and how they succeed. It is founded on the principle that nothing is impossible to the man who is determined and willing to try.

In territory not now covered, the right man is wanted. The investment in money is small, but investment in time and study is considerable. If you are willing to put forth the necessary effort to obtain a splendid, profitable business of your own, write and say "Send me your Ozarka Plan Book No. 100." It may be the turning point in your life. Don't fail to mention the name of your county. Use the coupon!



Let us send you the stories of Ozarka long distance reception — from many people who have heard London and Manchester, England; Cardiff, Wales; Glasgow, Scotland; Buenos Aires, South America; and even Honolulu, H. I. Write for free illustrated book No. 200. Please give name of your county.

# OZARKA

120 Austin Avenue M  
Chicago, Illinois



Ask the Man Who  
Wears this Button

# INCORPORATED

120 Austin Avenue M  
Chicago, Illinois

Gentlemen: Without obligation send book "Ozarka Instruments No. 200" and name of Ozarka representative.

Gentlemen: I am greatly interested in the FREE book "The Ozarka Plan" No. 100, whereby I can sell your radio instruments.

Name.....  
Address..... City.....  
County..... State.....

Name.....  
Address..... City.....  
County..... State.....



The Trimm Home Speaker is the biggest value in radio today. It out-performs other speakers costing twice as much. Model No. 25 has large Volconite horn, 18 inches high with a 12 inch bell and prevents tinny, scratchy noises, giving a full, well rounded tone.

Factory regulated adjustment assures maximum volume without blasting or distortion. Carries the Trimm Lifetime Guarantee of perfect satisfaction. Have your dealer demonstrate the Home Speaker to you before you buy.

*Trimm Headsets, Speakers and Units give radio fans the utmost in performance for their money. Dealers who wish to be shown, write for details.*

<b>TRIMM</b>	
Superior Reproducers	
HEADSETS	
Professional . . .	<b>\$5.50</b>
Dependable . . .	<b>4.40</b>
PHONODAPTERS	
Giant Unit . . .	<b>\$10.00</b>
Little Wonder . . .	<b>4.50</b>
SPEAKERS	
Home Speaker . . .	<b>\$10.00</b>
Entertainer . . .	<b>17.50</b>
Cabinette . . .	<b>17.50</b>
Concert . . .	<b>25.00</b>
Chello . . .	<b>30.00</b>



# “NOW, I HAVE FOUND . . .”

A Department Where Readers Can Exchange Ideas and Suggestions of Value to the Radio Constructor and Operator

*IN THE August RADIO BROADCAST it was announced that a prize of twenty-five dollars would be given to the reader who submitted the best idea for the “Now, I Have Found . . .” department, during each three months’ period. The best suggestion published during the last quarter is that of Mr. Welsford A. West, whose two ideas were published in the September number, on page 660. This award will be continued and announcement made every three months. All used manuscripts will be paid for at the usual rates, that is, from two to ten dollars each. Those submitted should be no longer than about three hundred words, and should be typewritten. Address your letters to this department, RADIO BROADCAST, Garden City, New York*

## MEASURING HIGH RESISTANCE

WHEN the experimenter constructs a resistance-coupled audio amplifier and doesn’t get proper results, he often wonders if the resistances used are in good condition and of correct values. Such resistances may be measured with a good-grade voltmeter of known resistance having about a zero to eight scale or less. If you don’t know your meter’s resistance, write to the maker. The use of good B batteries of about 90 volts is essential as using partly run down batteries will affect the results obtained.

Make connections as shown in the sketch, Fig. 1, the resistance under test being shown at X. Note voltmeter reading.

In a test made with some .1 megohm resistances, the B voltage was 90, meter resistance 496 ohms, reading .42 volts.

Substituting, X =  $90 \times 496 \div .42 = 106285$  ohms = .106 megohms.

Precaution: Test only high resistances such as used for the above purpose.

Testing low resistances will damage the meter.

The above formula is not absolutely correct according to theory, but error may be disregarded for practical purposes such as this test is suggested for.

CLAUDE SCHUDER, Sumner, Illinois.

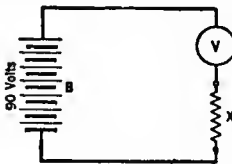

FIG. 1

## DESCRIPTION OF A NEW NP COIL FOR THE ROBERTS RECEIVER

THERE have been written reams and reams of information on the wonders and drawbacks of the now justly famous Roberts circuit. However, one very important point has been overlooked.

The big question usually asked was, “Why is my set dead on certain frequencies (wavelengths)?” This question being a serious one, every possible reason for this undesired condition was considered and an organized search for the cause of the trouble instituted. Transformers spaced too close to coils, coupling effects, high resistance condensers, open-circuited or defective coils, and a thousand and one other things suggested themselves at the time. After spending considerable time on this problem, a Roberts set which extended for over three feet on an old super-heterodyne panel, resulted from the experiments. The reason for this lengthy arrangement was to keep all instruments as far away as possible from

each other, and to avoid any detrimental feedback or absorption which might take place in a more congested layout. But the outfit still showed the same symptoms, and the only place left to look for trouble was in the design of the coils. Here was found the secret of the difficulty.

All descriptions of the NP coil have advised that this winding should be done in a rather peculiar fashion. That is, two parallel wires are wound at the same time over the same form, and are connected top to bottom in such a way that they form a continuous wire with a tap in the center. The reason for this peculiar type of winding is that it makes neutralization much easier. Be that as it may, it certainly does make everything else much more difficult.

Probably the reader of this article knows something about distributed capacity and perhaps he is a little uncertain as to what it is all about and why it is one of the things to be avoided in a radio receiver.

The electrical energy which flows through the coils of your radio set is much the same as water in a pipe, and the insulation of the wire in your coils forms the piping which holds in the current. The tendency of the electrical energy is to leak through the insulation. This tendency is altogether governed by the distributed capacity or leakage area and the amount of pressure. The leakage action generally takes place from one turn to the next and, as only a small amount of voltage builds up in one turn, the effective loss is very small. However, the regular Roberts NP coil is wound so that the potential difference between adjacent turns varies from zero to forty volts, which may be seen in B, Fig. 2. We can very easily calculate the mean voltage between windings or across the condensers. It is 20 volts. Therefore we have approximately twenty times the loss which we have in a coil of proper design.

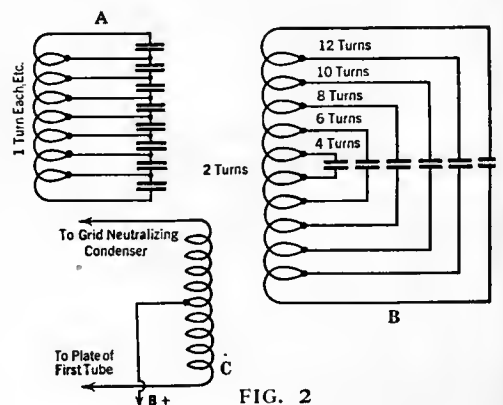

FIG. 2

# A New Conception of Radio

*A  
New Kind of Receiver  
No Dials - No Panel  
Built-in Loudspeaker*



*Ultra Simplicity ~  
Tastefully Unobtrusive*

★  
\$135

The Ultradyne, Model L-3 is a six-tube receiver employing the fundamental principles of the best circuits, greatly refined and marvelously simplified. No dials—no panel: Just two inconspicuous levers which constitute a station-selector. Duco finished, two-toned mahogany cabinet.

Designed by R. E. Lacault, E. E., Chief Engineer of this Company, and formerly Radio Research Engineer with the French Signal Corps Research Laboratories.

To protect the public, Mr. Lacault's personal monogram seal (R. E. L.) is placed on the assembly lock bolts of all genuine ULTRADYNE Model L-3 Receivers. All Receivers are guaranteed so long as these seals remain unbroken.



THIS new kind of radio-musical instrument marks the mastery of technicalities to the point where the whole range of radio's resources are literally at your instant command.

The Ultradyne, Model L-3, supplants the usual "laboratory machine." It is a new artistic table-piece that makes the entrance of radio into the well-appointed home *unobtrusive, inconspicuous*. It represents the triumph of art over mere mechanics.

The Ultradyne Receiver is worthy of the place of honor in luxurious homes.

The Ultradyne Model L-3 fulfills everything that the critically-minded have demanded of radio. Why wait any longer, why deny yourself the infinite treasures of radio? The ideal has at last been attained!

Skepticism will vanish if you will let your local dealer demonstrate this new modern radio receiver.

*Illustrated folder on request.*

PHENIX RADIO CORPORATION, 116-C EAST 25TH ST., NEW YORK

# ULTRADYNE

MODEL L-3

# We Sold 4000 Sets

Had 4000 Favorable Reports

## Before We Felt Justified to Say



## Quality Radio Apparatus

Now we invite you to go to your Apex Dealer who will be glad to make a personal demonstration for you in your home or in his store. A demonstration will prove to you that Apex Radio Receivers will give you everything you can possibly wish for in a radio receiver from standpoint of selectivity, clarity, volume, distance and attractiveness of design.

- The APEX Super Five without accessories... **\$95**
- The APEX De Luxe without accessories... **135**
- The APEX Baby Grand Console without accessories... **225**
- The APEX Utility Radio Table... **75**
- The APEX Entertainer (Loud Speaker).... **22.50**
- The APEX Console Entertainer... **27.50**

Upon request we will gladly mail you descriptive Folder

**APEX ELECTRIC MFG. COMPANY**  
Dept. 1104  
1410 W. 59th St. Chicago

Prices West of Rockies slightly higher  
Canadian prices approximately 40% Higher

There are also other factors which tend to make this type of winding unsuitable for use in a radio receiver, such as the high natural period of the coil and its inability to respond to different frequencies (wavelengths). However, we will not go into a discussion of these matters as they are largely dependent upon the master offender—distributed capacity.

Several different experiments were tried with this coil, and by removing turns enough to reduce the natural period to about two thousand kilocycles (150 meters), very satisfactory reception was had over the entire frequency band. However, the efficiency dropped very slightly at the lower frequencies (longer wavelengths), but this was expected as there were now too few turns for efficient transformation on the lower frequencies.

After trying several different styles of NP coils, the design which seemed most efficient for all around use consisted of an ordinary diamond weave coil containing forty turns of wire tapped at the 20th turn and connected in the following manner; inside lead to plate, center tap to B battery positive and outside lead to the neutralizing condenser. See C, Fig. 2.

A great many of these coils have been installed in Roberts receivers which had not been giving the best of results. This new style of NP coil has in every case shown far superior results to the old-style coils.

RALPH D. TYGERT,  
Springfield, Massachusetts.

### A GOOD NEUTRALIZING CONDENSER FOR THE ROBERTS CIRCUIT

AFTER experimenting with several types of neutralizing condensers on the market, from plate condensers to sliding condensers, it was found that the average type was either too large or too small, either in size and capacity, or that they were not efficient in operation. In making adjustments they were not protected against body capacity.

The condenser used in my laboratory for this purpose can be constructed in a few minutes from material to be found in any home laboratory. As Fig. 3 shows, the condenser is made by taking a piece of one quarter-inch copper tubing, one and one-half inches long, a piece of cambric

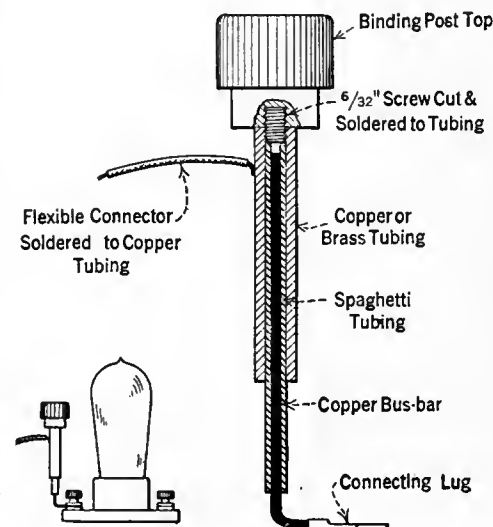

FIG. 3

spaghetti, two and one-half inches long, which is passed up into the copper tube at one end, and a three sixteenths-inch threaded binding post screw with the head cut off, to be soldered at the upper end of the copper tube. A bakelite binding post thumb grip is to be placed on this screw, which acts as a handle for making adjustment. A piece of insulated copper wire (flexible preferred) is soldered to the upper surface of the copper tube, which is to be connected to the N lead of the NP coil. The condenser is now nearly completed and the last step is to cut a piece of No. 14 copper bus bar wire long enough to pass into the cambric tubing two and one fourth inches, leaving enough to attach to a lug which is placed on the binding post of the tube socket marked G. The neutralizing condenser is now completed and when mounted on the tube socket as indicated in the drawing, should stand parallel to it. Neutralize in the usual way by simply sliding the tube back and forth on the bus bar.

H. A. FRANCHERE,  
Lake Crystal, Minnesota.

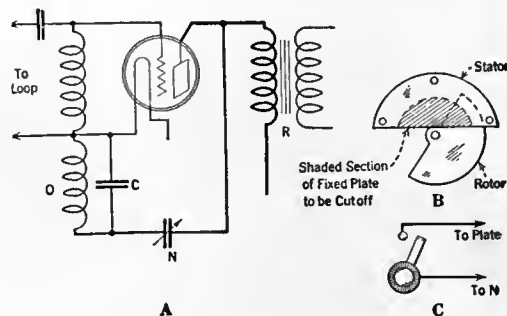

FIG. 4

### SHORT WAVES ON THE HANSCOM SUPER-HETERODYNE

SOME builders of this set have noticed that the volume on the high-frequency (short-wave) stations is not as great as from stations operating on lower frequencies (longer waves.) Theoretically, the super-heterodyne should give uniform amplification throughout the entire range of frequencies, but the Hanscom circuit makes use of regeneration in the first tube, thus making possible the great volume which the set possesses for loop reception. The diagram A, Fig. 4, shows the circuits of the first tube. The condenser N is usually of the midget variable type. It will be noticed that as its capacity is decreased the signal strength increases rapidly until the first tube breaks into oscillation. The radio frequency output of the first tube goes through the iron core radio-frequency transformer R. The action of the condenser N, is to prevent a tuned plate feed back by by-passing radio frequency through itself and the fixed condenser C. At the same time as N is increased, there occurs a feedback through the coil D which acts as a tickler at intermediate frequency.

On the short waves it will be noticed that there is no tendency for the first tube to oscillate and this is caused by the residual capacity of the condenser N even though set at zero. To prove this, it is only necessary to disconnect the wire from the plate of the tube to N and a great increase in signal strength will be noted.

With N set at zero, the first tube will oscillate as we go up the scale, usually at about 750 kilocycles (400 meters) but with



# The New WAVE MASTER - a Radio Set Worthy to Bear the KELLOGG Name



**The Wave Master Console Model**  
 A handsome genuine mahogany design with battery compartments and inbuilt horn. Price, **\$275.00**  
 Without battery table, price - **\$225.00**  
 Also made in the beautiful Consollette model, genuine mahogany, price, **\$235.00**



**A Year Ahead! The WAVE MASTER, 5-Tube Standard Model**  
 Cabinet of solid, Genuine Mahogany, beautifully finished, 28 inches long, 11 inches high. Price, **\$125.00**

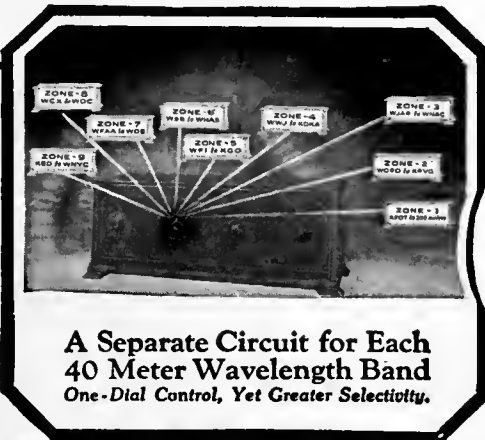

**A Separate Circuit for Each 40 Meter Wavelength Band**  
 One-Dial Control, Yet Greater Selectivity.



**Kellogg Symphony Reproducer**  
 \$25.00

**"I never dreamed it was such fun"**

"I used to be content to enjoy radio merely as a listener, never realizing how much greater pleasure I was missing. I had no idea of the fascinations of radio tuning—the fun of going after any station and getting it."

**W**HEN you make a telephone call, the operator connects you first with the "exchange" and then with the desired number of that group or division.

To "connect" the WAVE MASTER instantly with any desired broadcasting station, you first set the pointer for the "Exchange" or wave zone group to which the station belongs and then merely turn the Station Selector dial. "Expert" tuning becomes child's play. To separate stations very close together in their wavelengths, is astonishingly easy. When buying any radio set, protect yourself by learning something about the firm that produced it—their reliability and experience. For 28 years Kellogg has produced the finest of telephone apparatus. Since radio began Kellogg has built the highest quality parts.

If you do not know where you can see, try and hear the WAVE MASTER in your neighborhood, write us. We'll give you the name of your nearest dealer, and, if you wish it, a full technical explanation of the Wave Master Circuit. Ask for Folder No. 5-K

**Radio Dealers and Jobbers**

The WAVE MASTER franchise backed by Kellogg resources and our powerful advertising campaign, is most valuable. Open territories are being rapidly taken up. If interested, wire or call on us promptly for our money-making proposition.

**Kellogg Switchboard & Supply Company**  
 1066 West Adams Street, Chicago, Illinois

# KELLOGG WAVE MASTER SWITCHBOARD & SUPPLY CO.

# BURGESS RADIO BATTERIES *Win Again*



©U. & U. Photos.

The illustration pictures the take-off of the winning flight and in the insert is the radio equipment carried. (Burgess "A", "B" and "C" Batteries furnished the electrical energy to operate the set.)

When the Goodyear III won the right to represent the United States at Belgium, Burgess Radio Batteries supplied the electrical energy for the operation of the balloon's radio equipment.

Almost every day from somewhere in the world news comes to us of new Burgess adventures.

And that Burgess Batteries have contributed their bit in so many interesting events of sport, commerce and science reflects the esteem in which they are held.

*"Ask Any Radio Engineer"*

Your own radio dealer down the street sells Burgess Batteries. He probably sells the famous Burgess Flashlights, too.

**BURGESS BATTERY COMPANY**  
GENERAL SALES OFFICE: CHICAGO

Canadian Factories and Offices:  
Niagara Falls and Winnipeg



the above mentioned wire disconnected, the first tube will oscillate at about 1000 kilocycles (300 meters). Unfortunately there is no small variable condenser available with a minimum capacity sufficiently low to function on the shorter waves with maximum efficiency. To those who are experimentally inclined, we suggest the cutting of the fixed plates of a three-plate vernier as indicated in B, the point being

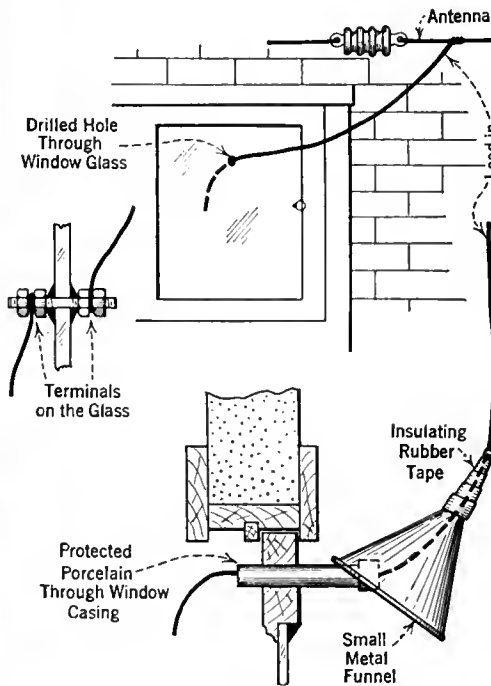

FIG. 5

to make a condenser with a wide separation between the edges of the fixed and rotating-plates at zero setting. It is also possible to connect a single point switch so that the condenser N may be cut out of the circuit as indicated in C. Needless to say, the leads to the condenser N from the set should be as short and direct as possible, particularly the lead from the plate of the tube.

A. T. HANSCOM,  
Woonsocket, Rhode Island.

### A LEAD-IN PROBLEM

A RADIO friend of the writer, erected an antenna some hundred and twenty-five feet in length, about forty feet above ground, brought the lead wire down past the drain spout, and under the lower sash of the window directly in contact with the stone sill.

Results; a strangled band and gagged call letters, with other muffled sounds, were received with the aid of five tubes in a high-priced receiver.

It took one radio expert about ten minutes to fix up the antenna and about three hours explaining to this friend why his antenna failed, even though at this time the latter is hardly convinced of having made any grave error in running the wire as he did.

The manner of leading in an antenna wire, which was used to correct this aforementioned mistake, is illustrated in the attached sketch, Fig. 5, and is about the cleverest and most practical of any which the writer has observed. A single small hole is drilled through the center of the window glass. The antenna lead passes through this hole obtaining insulation of the

most desirable type, and at the same time providing a support for the wire. The same idea can be further improved by the use of a small threaded rod having screw terminal nuts at each end to attach or detach the lead wire. In drilling through the glass, it is advisable to use a small hard drill with turpentine as a drill lubricant, turning the drill quite fast and giving only enough pressure to cause the drill to cut.

In another illustration shown in the same sketch, a method of leading the antenna through the window casing is shown. The antenna wire leads through a porcelain tube, placed through a bored hole in the wood. Surrounding the lead through the porcelain, is a small metal funnel, secured with tape as shown in the sketch. The funnel not only prevents the water following through the tube, but it also keeps the lead dry below this point, preventing a leak which would be found detrimental to reception.

G. A. LUERS,  
Washington, District of Columbia.

### AN EFFICIENT COIL COVERING THE BROADCASTING FREQUENCIES

I HAVE found that with the 35-turn coil which is illustrated in Fig. 6 and shunted by a good .0005 mfd. variable condenser, frequencies from 1500 kilocycles (200 meters) to 545 kilocycles (550 meters) may be covered, and I know of no other winding in which 35 turns will cover this range.

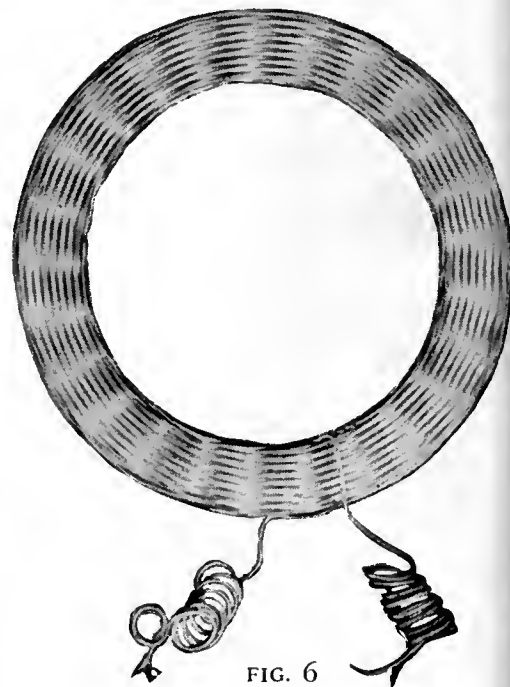

FIG. 6

This coil is wound on a form 3 inches in diameter, with 25 pegs equally spaced, and is wound over two and under two, and sewed as shown in the photograph, Fig. 6.

W. H. MAYFIELD, Miami, Arizona.

### About Contributions

THIS department particularly welcomes short manuscripts relating to all matters pertaining to workshop practice, such as the handling of tools, and general hints of a constructional nature. These, as in the one of other contributions for the "Now I Have Found . . ." section, should not be longer than about 300 words and should be typewritten.

**EVEREADY HOUR**  
**EVERY TUESDAY AT 9 P. M.**  
*Eastern Standard Time*

For real radio enjoyment, tune in the "Eveready Group." Broadcast through stations—

<b>WEAF</b> New York	<b>WCAE</b> Pittsburgh
<b>WJAR</b> Providence	<b>WSAI</b> Cincinnati
<b>WEEI</b> Boston	<b>WWJ</b> Detroit
<b>WFI</b> Philadelphia	<b>WCCO</b> Minneapolis
<b>WGR</b> Buffalo	St. Paul
<b>WOC</b> Davenport	

# ALWAYS RELIABLE

EVEREADY Radio Batteries are always uniform and reliable! Evereadys perform the same, everywhere, for everybody, needing no skill, calling for no experimentation, wasting no time, saving you money. Trouble-proof, wonderful Evereadys. There is an Eveready dealer nearby.

*Manufactured and guaranteed by*

**NATIONAL CARBON COMPANY, Inc.**  
 New York San Francisco

Canadian National Carbon Co., Limited, Toronto, Ontario

## ★ EVEREADY Radio Batteries

*—they last longer*



Eveready Columbia Ignitor "A" Battery, the proven dry cell for all radio dry cell tubes 1½ volts

No. 766  
 22½-volt  
 Large  
 Horizontal  
 Price  
 \$2.00



No. 486  
 45-volt  
 Layervolt  
 Extra-Large  
 Vertical  
 Price  
 \$5.50

A practical,  
authoritative book on  
**RADIO**



100,000 SOLD  
514 PAGES

Compiled by  
HARRY F. DART, E.E.

Formerly with the  
Western Electric  
Co., and U. S.  
Army instructor of  
Radio. Technically  
edited by  
F. H. DOANE.

**BE A RADIO EXPERT**—it's easy for the 100,000 who own this compact, complete Radio Handbook. Written in good, plain, understandable language. Crammed full of facts, every one useful and important. Explains how receivers and transmitters work, how to build and operate them. Whatever you or your friends want to know, it's here. Will save you many times its small cost.

**TELLS ALL ABOUT:** Electrical terms and circuits, antennas, batteries, generators and motors, electron (vacuum) tubes, most receiving hook-ups, radio and audio frequency amplification, broadcast and commercial transmitters and receivers, super-regeneration, codes, license rules. Many other features.

Nothing else like it. Make this extraordinary book your radio library—just this one little giant is all you need. Everything in one index, under one cover, in one book, for one dollar. The biggest dollar's worth in radio today. Combines the knowledge of many expensive works. Buy this and save the difference.

Just mail the coupon with a dollar bill and your name and address, and this 514-page I. C. S. Radio Handbook will be sent to you by return mail. Note the other good books listed below at low prices.

International Correspondence Schools  
Box 8295-E, Scranton, Penna.

I enclose \$....., for which send me, post-paid, the Handbooks marked X, at \$1 each. It is understood that if I am not entirely satisfied I may return them within five days and you will refund my money.

- RADIO HANDBOOK, 514 PAGES, \$1**
- Automobile Handbook, 354 pages - - - \$1
- Electrical Handbook, 414 pages - - - \$1
- Chemistry Handbook, 348 pages - - - \$1
- Pharmacy Handbook, 324 pages - - - \$1
- Traffic Handbook, 388 pages - - - \$1
- Building Trades Handbook, 409 pages - - - \$1
- Machine Shop Handbook, 335 pages - - - \$1
- Salesman's Handbook, 352 pages - - - \$1
- Advertising Handbook, 445 pages - - - \$1
- Bookkeeper's Handbook, 302 pages - - - \$1
- Civil Engineer's Handbook, 411 pages - - - \$1
- Steam Engineer's Handbook, 298 pages - - - \$1

Name.....

Address.....

Enclose \$1.50 instead of \$1 for each book if you want the leatheraid binding. All of the above books can be had in this binding except the Traffic Handbook and the Building Trades Handbook.

# THE GRID

A Department Devoted to Solving the Problems of our Readers

## QUERIES ANSWERED

1. WILL YOU GIVE ME A CLEAR, NON-TECHNICAL EXPLANATION OF STATIC AND FADING?—A. R. S.—Yonkers, New York.
2. ON THE LONGER BROADCAST WAVELENGTHS MY RECEIVER PRODUCES POOR VOLUME. WHAT IS THE CAUSE?—A. C. P.—Grove City, Pennsylvania.

3. WILL YOU DESCRIBE THE CONSTRUCTION OF BOX AND SPIRAL LOOP ANTENNAS?—R. M. C.—Oak Park, Illinois.
4. HOW MAY THE NEW TOROID COILS BE SUBSTITUTED FOR THOSE NOW CONTAINED IN NEUTRODYNES AND OTHER TUNED RADIO-FREQUENCY RECEIVERS?—T. J. Mc G.—Hartford, Connecticut.

### EXPLAINING STATIC AND FADING

**M**ANY times have the questions been asked, what is static; what causes it; what is fading?

At the present time much attention is being given to the subject of static and in answer to the specific question of our correspondent, nothing could be more timely in answer than the paper prepared by Dr. A. F. Van Dyck, on this very interesting topic. Dr. Van Dyck is a former General Electric engineer and at present is connected with the Radio Corporation of America. His recent researches on the static problem admirably qualify him to speak on the subject:

"First, let us consider what radio transmission is. We know that a radio sending station sends out from its antenna, in all directions, a disturbance of electric forces. We cannot see or hear or otherwise observe with our senses just how this disturbance behaves, as we can with light waves and sound waves. We consider it quite natural that a stone wall stops the light beam from a searchlight, or that a bugle call can be heard much farther over water than through a forest, or that under certain air conditions on a desert the mirage phenomenon is observed. So to know what to expect in radio, we need only to remember that some things in space will stop, or reflect, or perhaps absorb the traveling radio waves, just as some other things in space stop or absorb or reflect light waves or sound waves.

"Substances which are obstructions to light or sound waves are not necessarily such to radio waves. For example, we know that radio waves pass through the walls of a house with only slight loss. But there is some substance in the space around the earth which does have effect upon radio waves. This substance is not uniformly distributed through space but is present here and there, is continually changing location and magnitude, and consequently has very erratic effects on the passage of radio waves. The condition is quite similar to the use of a searchlight in a fog which might be varying rapidly in density or location, or both. This radio fog is commonly supposed to be made of ionized air, that is, air which by some influence has become a partial conductor of electricity. Of course it never stands still and is changing from moment to moment under the influence of the complicated conditions of our atmosphere, and so the radio wave passing through space has an adventurous journey because it meets electrically charged clouds, patches of ionized air, and perhaps other obstacles of which we know nothing.

"It is a fact, often observed, that it is possible to work radio communication over much greater distances at night than in the daytime. This

may be explained by the effect of the sun upon the air, which causes ionization of it, and is most active in the daytime, and practically absent at night. The sun seems to be responsible, without question, in view of the fact that very erratic results in long distance reception are always noticed at sunrise and sunset.

"With the preceding statements in mind it should be clear that when one is receiving over long distances—several hundreds of miles—it is natural for the waves to come through strong at one moment, and to fade away considerably the next moment, as some obstacle to radio waves comes between the transmitter and receiver. This explains, too, why one transmitting station, of two or more which are being heard, may get weaker, while the others do not. These effects are much more frequent in the summer than in the winter season, presumably because of the greater influence of the sun on earth and its atmosphere during that season.

"These ionized clouds sometimes reflect the waves, much as a mirror does a light wave, and very peculiar reception effects are sometimes noticed. Sometimes the signals are made stronger instead of weaker, sometimes they may be lost altogether, as the several effects of reflection and absorption combine.

"And now, let us consider that arch enemy of radio—static. When Marconi first began to receive messages over distances of a few miles he noted, besides the signals he was listening for, noises which had nothing to do with the signals.

"These noises have been called strays, or atmospherics, or static, and their elimination is the most important problem in radio communication to-day. The intensity of this disturbance is different at different parts of the earth's surface, being progressively worse from the temperate to the tropical zones. The intensity of static varies greatly with the seasons of the year. For example, in the northern part of the United States, it is practically absent during the winter months, increases during the spring, and is most severe during the summer. There are at least two or three kinds of static, but the most troublesome kind is the one which is due to traveling electric waves, in nature just like radio waves, and caused by electrical disturbances somewhere in space. A lightning flash produces a traveling electric-wave, much like a radio wave, and if we can assume that lightning flashes, large and small, are occurring continuously somewhere we have a reasonable explanation of static. Of course, these discharges do not always manifest themselves by a display of lightning, the majority in fact being small discharges inside of or between clouds. Also it is probable that the continuous

(Continued on page 84)

*Your  
Radio*

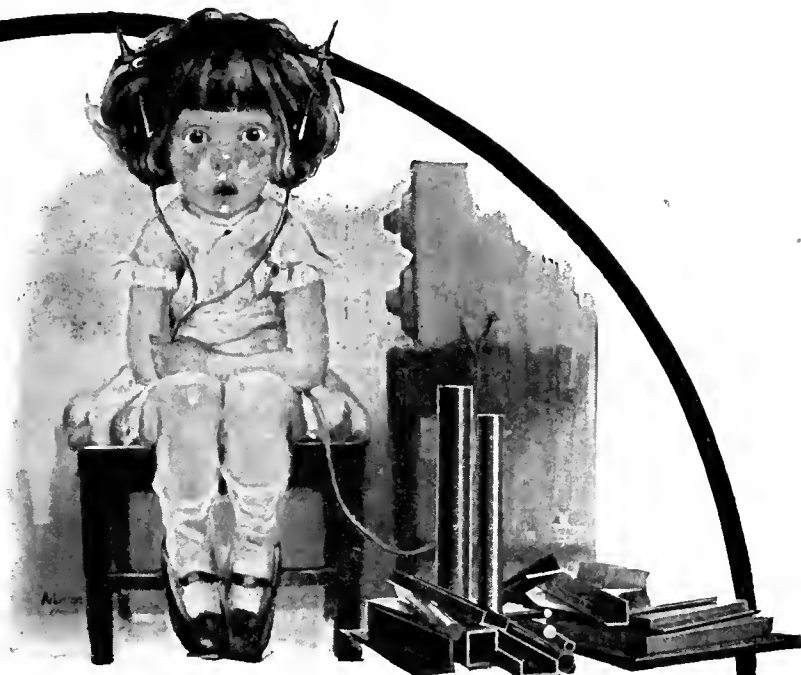

*and* **MICARTA**

**Y**OUR radio will be built of the best only when a Micarta panel adds efficiency and beauty to careful building.

It is the easiest of materials to engrave and machine. Smooth holes may be drilled without the slightest sign of a chip. It is not affected by temperature changes, water or oil.

Micarta panels are now available in the soft, deep gloss of mahogany and walnut as well as in black. You will find them at your dealer's packed in the orange and black envelopes.

Westinghouse Electric & Manufacturing Company  
East Pittsburgh Pennsylvania  
Sales Offices in All Principal Cities of  
the United States and Foreign Countries



**W**  
**MICARTA**  
REG. U.S. PAT. OFF.  
**RADIO PANEL**

Micarta is used by leading radio manufacturers because of its low power loss, high dielectric strength and pleasing appearance. Micarta radio panels can be drilled and machined with ease.

SEE DIRECTIONS ON OTHER SIDE  
Westinghouse Electric & Manufacturing Co.  
EAST PITTSBURGH, PA.

**Westinghouse**

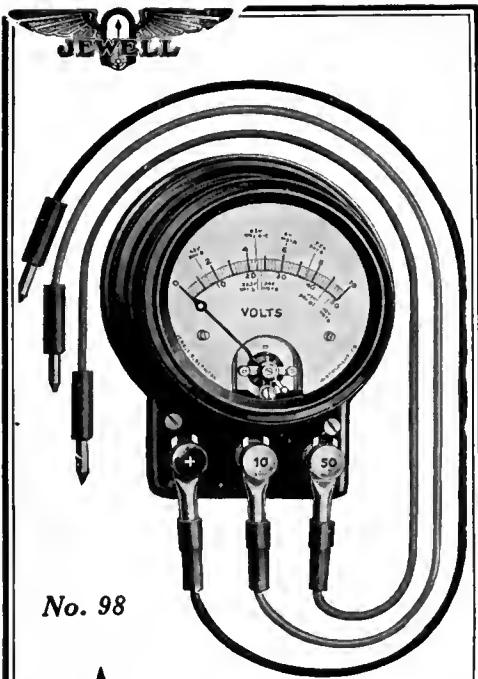

No. 98

★  
**60%—**

of all radio trouble can be traced to weak or poor batteries. This is not a guess but the actual percentage shown by an extensive survey made by a large manufacturer of radio sets.

Don't guess—Be sure—Be accurate—Test your batteries frequently. Save time and expense and get the best results and greatest pleasure out of your set.

There is a Jewell radio testing instrument to meet every need or pocketbook (\$2.00 to \$75.00). The No. 98 Voltmeter shown above is being used by dealers to test batteries as customers buy them.

Send for our 15-B Radio Catalog

**Jewell Electrical Instrument Company**

1650 Walnut St., Chicago, Ill.

atmospheric changes above the surface of the earth, such as the formation of water vapor clouds, are accompanied by electrical disturbances which travel to the earth.

"We know that static is worse in the summer when variations in the atmosphere are greater and more frequent. Also it is often observed in the winter time that the formation of snow causes static. Without knowing definitely the origin of this disturbance, it seems safe to assume that the actions which take place in our atmosphere, due to the air, the sun, sun spots, water vapor, etc., are responsible for the creation of these irregular, irresponsible, and very troublesome waves which we call static. Since they are so much like the radio waves in nature, no way has yet been found of eliminating them completely. Progress has been made in the last few years, however, and the transoceanic stations are much more free of this interference than formerly. The problem of complete elimination of static is the most difficult one in radio, and if solved, we shall have a new epoch in radio because it will then be possible greatly to reduce the power of transmitting stations and the reliability of communication increased."

RECEIVER COIL RESISTANCE

MANY owners of radio receivers observe that their sets will respond quite satisfactorily on the lower end of the scale of the condenser dial, but above a certain setting the volume produced will decrease considerably and the selectivity is not as sharp as is desirable.

Granting that a thorough inspection of a receiver has disclosed no error in circuit wiring or defect in coils, tubes, etc., it is fair to assume that this condition is due to the use of coil units which, while otherwise O. K., have an exceedingly high resistance at the higher end of the condenser scale.

Resistance in a coil may be attributed to 1. insulation within the field of the coil, such as tubing, panels, and other nearby objects; 2. the use of "dope" which is used as a binder to hold the coil together; 3. the use of fine wire (ordinarily circuits should employ coils wound with wire not smaller than No. 28 wire or larger than No. 18 d. c. c.)

Resistance here should not be confused with the ordinary use of the term where it is employed to indicate the direct resistance of a piece of wire. Rather, it is a value which changes with each change in frequency to which the circuit may be tuned. This is brought out quite clearly in the table of measurements which follows. These measurements were obtained by a regular laboratory procedure.

FREQUENCY	RESISTANCE	
	COIL NO. 1	COIL NO. 2
1500 KC. (200M) . . . . .	75.5 ohms	95.5
1200 KC. (250M) . . . . .	38.5 "	108.5
1000 KC. (300M) . . . . .	24.5 "	300.0
750 KC. (400M) . . . . .	16.5 "	72.0
600 KC. (500M) . . . . .	35.5 "	18.5
500 KC. (600M) . . . . .	10.5 "	12.5

From the above it will be observed that in coil No. 2 the resistance gradually rose from 95.5 ohms at 1500 kc. (200 meters) to 300 ohms at 1000 kc. (300 meters) and then gradually decreased to 12.5 ohms at 500 kc. (600 meters). In all receiving circuits it is essential that the resistance of the tuner circuits be kept as low as possible. Where this is not the case, poor selectivity, with a loss in volume, is sure to result.

Obviously the solution to this problem lies in the use of coils having a minimum of resistance which depends upon the several points as here-

tofore discussed. Broadcast listeners do not usually have the means to make these measurements, however, and it is necessary for them to judge entirely by ear and eye in the matter of volume and selectivity. But for those who do have means for making these measurements, the following table of measurements of a coil which has proven satisfactory is given for comparison.

FREQUENCY	RESISTANCE
1500 KC. (200M) . . . . .	20.5 ohms
1200 KC. (250M) . . . . .	12.5 "
1000 KC. (300M) . . . . .	12.5 "
750 KC. (400M) . . . . .	10.5 "
600 KC. (500M) . . . . .	8.5 "
500 KC. (600M) . . . . .	7.5 "

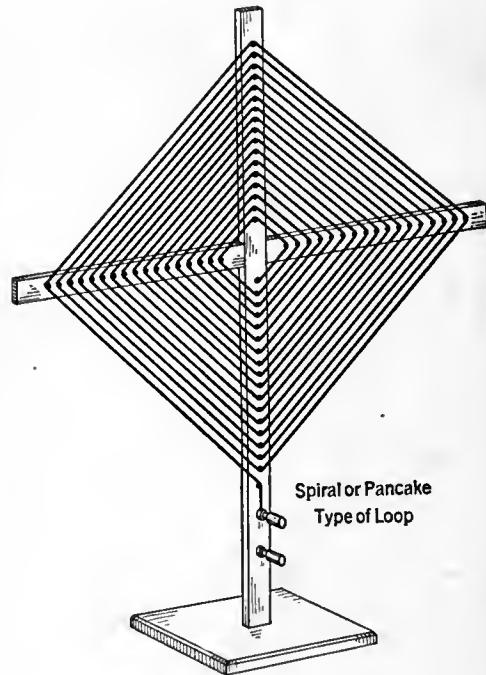

FIG. 1

LOOP CONSTRUCTION

IN THE main, two types of loops are used for reception. The spiral type, more commonly known as the pancake type, is the easier of the two to build. It has marked directional effects and may be used successfully in a direction-finding station. See Fig. 1.

To construct this type of loop two pieces of one inch square wood are required, one thirty inches long, the other twenty-four inches long. The shorter of the two is the horizontal piece while the other is the vertical piece, to which may be fastened an appropriate base. By means of a half lap joint, the two sticks are fastened together to form a cross.

The two pieces are so crossed that three of the arms will measure 12 inches from the point of intersection, while the fourth, which is fixed to the base, measures 18 inches.

Five inches out from the centre, on each of the four arms, is placed a No. 4 round head brass wood screw 1/2 inch long. Fifteen more screws of the same size are located on each of the four arms, each screw being placed 3/8 of an inch apart.

The winding of the wire is begun on the inside screws and outward, the two ends of the wire being made fast to binding posts located at the lower end of the vertical arm. Stranded wire having double silk or cotton covered insulation will be found best.

In Fig. 2 is shown the box type of loop which consists of a specially constructed frame upon which is wound the wire in a horizontal plane. Its constructional details are apparent from a reference to the illustration. The depth of the

*Another*  
**BOSCH  
 RADIO  
 PRODUCT**



PRICE  
**\$14<sup>50</sup>**

*The*  
**Junior AMBOTONE**

**A** **NOTHER** Bosch Radio triumph. The announcement and immediate nationwide acceptance of the Bosch Radio Receiver, and the Bosch Reproducer, the Ambotone, is now followed by another Bosch Radio product.

Bosch now announces the Junior Ambotone. The Junior Ambotone is a radio reproducer with an unusual tonal quality built to the famous Bosch standard of precision. Following the Ambotone principles of reproduction, the Junior Ambotone gets its mellowness from wood.

The Bosch ability to manufacture to precision standards, accounts for the tone quality. The Bosch ability to build with accuracy in quantities accounts for the remarkably low price. The greatest value in radio—the Junior Ambotone—at \$14.50.



**American Bosch Magneto Corporation**

SPRINGFIELD, MASS.

★ Tested and approved by RADIO BROADCAST ★

## Rhamstine★ TUBE BOOSTER



Rhamstine★  
Tube Booster

Only \$6

Your radio enjoyment depends largely on the tubes. If they do not function properly you can not get a full, clear tone. They can be made "just like new"—Rhamstine★ Tube Booster renews their youth with all that the word implies—pep, freshness, a true, full, round tone which carries the message as "clear as a bell." Why buy new tubes when the Rhamstine★ Tube Booster assures you of perfect radio enjoyment. Works on any alternating current 110-120 volts, 50-133 cycles. It matters not whether you use 201-A or 199 Type Tubes.

Send no money—check the coupon below—pay on delivery.

## "B" Rectifier Eliminates "B" Battery



Rhamstine★ "B" Rectifier

Only \$25

The Rhamstine★ "B" Rectifier is a quality product which furnishes an always dependable source of "B" power. It eliminates "B" Battery troubles such as chemical action, dead cells, recharging, and gives a continuous and uniform current, reproducing perfectly the original sound.

The cost is nominal compared to the pleasure and satisfaction derived from the service it performs.

Send no money—just check the coupon. The "B" Rectifier is shipped on 5-day approval. If not satisfied, your money will be refunded as cheerfully as the sale is made.

### Mail the Coupon To-day

J. THOS. RHAMSTINE\* (11)  
506 E. Woodbridge, Detroit, Mich.

Please send me  
 your Tube Booster at \$6  
 your "B" Rectifier at \$25  
 by express C. O. D. subject to inspection. If I am not entirely satisfied with the "B" Rectifier I will return it to you in five days and receive a refund of the full purchase price.

Name.....

Address.....

**J. THOS. RHAMSTINE★**  
*Radio and Electrical Products*  
 506 E. Woodbridge St., Detroit, Mich.

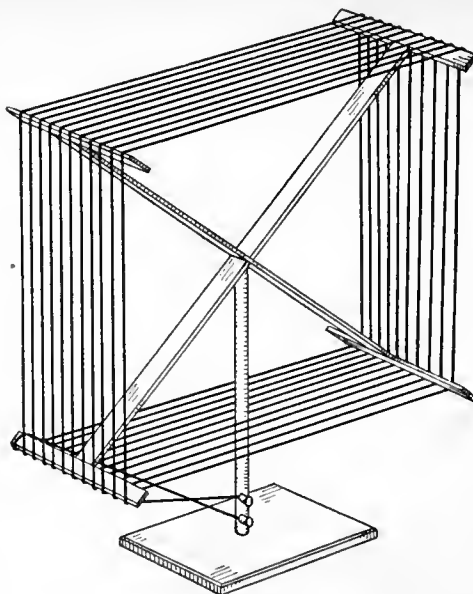

FIG. 2

box is 9½ inches and the diagonal pieces are 36 inches long. Sixteen turns of loop wire are wound on the frame, the turns being separated ½ inch.

### SUBSTITUTING TOROID COILS IN NEUTRODYNES

LATELY the toroid type of coil, under many different trade names, has come to the front as a promising substitute for the coil unit in receivers where inherent neutralization was not possible. This new type of coil possesses the property of confining its electro-magnetic field within itself. With other coils the field usually shapes itself outward and around the coil, thus interlinking with the

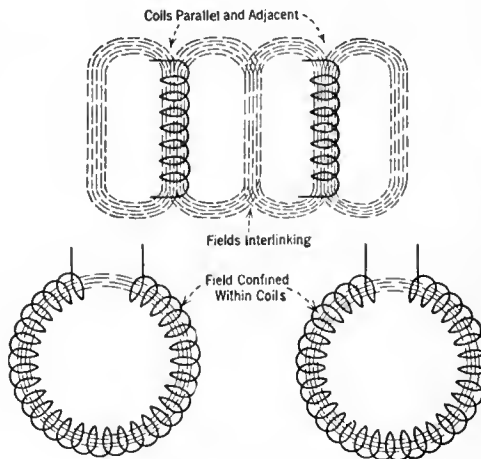

FIG. 3

fields of nearby coil units and causing uncontrolled oscillation due to energy feedback. See Fig. 3.

To replace the older type of cylindrical coil with a toroid in a neutrodyne, for instance, is not a difficult matter. The toroids have four binding posts as terminals for their windings. These are P, B, G, and F, not unlike those markings for audio-frequency transformers.

When the toroid coil is used as an antenna coupler, the terminals P, B constitute the antenna-primary coil to which are connected the

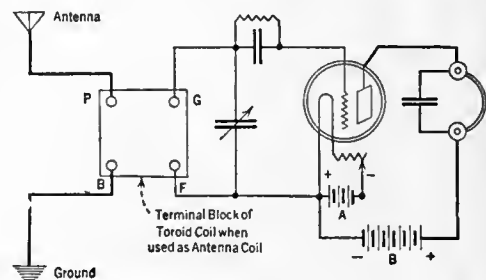
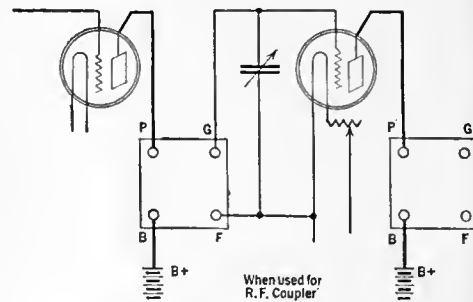
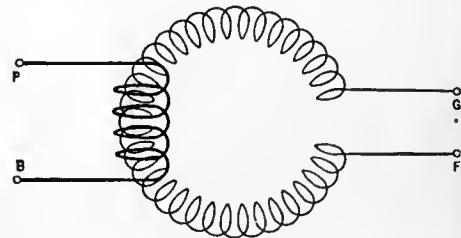

FIG. 4

antenna and ground leads. When used as an inter-stage coupler, in a radio-frequency circuit, the terminals P, B constitute the plate (primary) winding, terminal P connecting to the plate of the preceding tube and terminal B connecting to the positive B battery lead.

In both instances the secondary terminals G and F connect to the grid and filament leads of the next tube. The several points brought out in this discussion are evident in Fig. 4. The above is true only of coils having two distinct windings, primary to secondary, and does not hold when a tap is taken off the coil for antenna use.

### GRID INQUIRY BLANK

Editor, The Grid  
 RADIO BROADCAST  
 Garden City, New York

DEAR SIR,

Please give me the fullest information on the attached questions. I enclose a stamped envelope.

I am a subscriber to RADIO BROADCAST and therefore will receive this information free of charge.

I am not a subscriber and enclose \$1 to cover cost of answers.

NAME.....

ADDRESS.....  
 G. N.



# Hear This Innovation in Radio Receivers

## The Empire Model

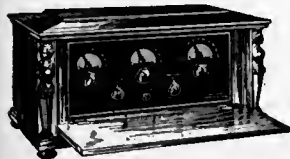

Enclosed in a 17th Century solid mahogany French Cabinet with hand carved figures, housing all batteries... **\$100** (without accessories)

The David Grimes Inverse Duplex Empire and Renaissance models are in reality six-tube sets, utilizing only four UV 199 tubes. This is accomplished by inverse duplexing which permits the dual operation of vacuum tubes, at the same time delivering a natural tone quality which is so noticeably lacking in most present day receivers. Incorporated in these models are two stages of sharply tuned radio frequency amplification, vacuum tube detector, and three stages of audio frequency amplification. A conveniently located super-power switch gives tremendous reserve power on distant stations when necessary. Remarkable selectivity is gained by the use of straight line condensers and a new form of inductance, the twin cylinder coil, which was developed in our laboratory after months of research.

## The Renaissance Model



Enclosed in an Italian Renaissance Cabinet of a beautiful two tone mahogany and walnut, housing all batteries **\$100** (without accessories)



The supreme achievement of the world famed Radio Engineer, David Grimes—sharply selective sets that tune in the stations you desire and hold out all others. Distant or local programs are sustained with marvelous clearness and superb tone, just as they are broadcasted, without annoying interference.

Built on the Grimes Inverse Duplex principle in which there is a dual operation of the vacuum tubes.

You've expected something new, something that would give real pleasure—by all means hear these instruments!



### Look for this Emblem

It identifies your authorized Grimes dealer who will gladly demonstrate any of the instruments pictured herein.

*Products of the*  
**DAVID GRIMES RADIO and**  
**CAMEO RECORD CORPORATION**  
1571 Broadway, New York, N. Y.

★ DAVID ★  
**Grimes**  
**SUPER SELECTIVE SERIES**

## Baby Grand Model



A three-tube duplex receiving set that uses UV 199 tubes. Incorporates one stage of tuned radio frequency amplification, tube detector and two stages of audio frequency amplification. A powerful, super selective set that gives exceptional volume and an excellent distant range. In two tone mahogany cabinet, housing all batteries. **\$59.50** (without accessories)

All of the essential units of the various instruments are developed and built within the Grimes plant. The sets are factory tested, sealed and guaranteed before they are put on the dealer's shelves.

## The Grimes Super Tone Loud Speaker

**\$25**



A really realistic reproducer—non-metallic in composition with a mica diaphragm that eliminates distortion.

Whether the deep mellow notes of the cello or the fluttering notes of the gifted soprano are taken from the air—a sweet clear rendition of the voice or music is always secured.



## The New PRECISE Syncrodenser

A scientific combination of straight line frequency where that is vital, with straight line capacity where that is superior.

By use of the Syncrodenser the lower half of the dial range has fewer stations, while the upper half contains many stations found between 0 and 50 on ordinary condensers. This absence of crowded stations on the lower half of the dial permits finer tuning and tremendously increases the selectivity of any set. The Syncrodenser is strongly built and can be mounted on panel or subpanel in any position. Prices, .0005 mfd. cap. \$4.50; 00035 mfd. cap. \$4.00.

## THE MONSTER PRECISE No. 480

A master transformer, designed for radio reception in a concert hall or ballroom if necessary. It brings forth the deep, rich tones as well as the high clear tones with perfect amplification. Made in two ratios,  $2\frac{1}{2}$  to 1, and 5 to 1. Price, \$7.50, either ratio.

PRECISE MFG. CORP.  
ROCHESTER, N. Y.



THE PRECISE SUPERSIZE  
No. 480 AUDIO TRANSFORMER

# THE BEST IN CURRENT RADIO PERIODICALS

The First Installment of a Useful Classified Survey of Material Appearing in the Radio Press

By E. D. SHALKHAUSER

How This Survey Can Help You

**H**OW often have you looked for information contained in some article which you recall having read months ago—the description of the Browning-Drake receiver, or the measurement of losses in inductance coils, for example? After looking through probably several issues of a dozen different publications you either give up or become interested in something altogether different.

When data is wanted on some particular subject, a systematic file of subjects and titles becomes a real radio encyclopedia. Instead of having merely the title of an article given, which often is misleading, a summary of the contents gives all the information. These surveys cover the radio field as gleaned from material in to-day's periodicals. They will always serve as a future reference-guide to all who are interested in the science of radio, whether engineer, manufacturer, dealer, experimenter, or listener.

To be of practical value and easily accessible, these surveys should either be filed in a scrap book, or pasted on individual cards and filed according to numbers, or alphabetically. In the matter of classification of articles, the Bureau of Standards circular No. 138 has been followed. This may be obtained from the Government Printing Office, Washington, District of Columbia, for ten cents. In addition, each abstract has certain key-words placed at the upper right, which may be used for the purpose of filing articles alphabetically.

With this series of surveys we hope to aid our readers and help them through many difficulties which they no doubt have often experienced. In future we will give information and references to articles previously surveyed upon receipt of a stamped and self-addressed envelope.

Following is a brief outline of the Dewey Decimal System used in the Bureau of Standards circular No. 138:

### R000 RADIO COMMUNICATION IN GENERAL.

Under this heading will appear all subject matter pertaining to laws, regulations, history, publications, etc., which deal with radio in a general way.

### R100 PRINCIPLES UNDERLYING RADIO COMMUNICATION.

Here will be given the phenomena of radio waves, their underlying theory of propagation, the principle of antenna and counterpoise, design and characteristics of vacuum tubes and their behavior in circuits, types of circuits, transmitting and receiving apparatus and their principles of operation.

### R200 RADIO MEASUREMENTS AND STANDARDIZATION METHODS.

The various known methods which have been used in measuring frequency, wavelength, resonance, capacity, inductance, resistance current, voltage, dielectric constants, and properties of materials, will be mentioned here.

### R300 RADIO APPARATUS AND EQUIPMENT.

A description of various types of antennas and their properties, the use of the electron tube in various types of receiving and transmitting sets, other methods of transmission of signals, various detecting devices used in reception, instruments and parts of circuits, come under this heading.

### R400 RADIO COMMUNICATION SYSTEMS.

The spark, modulated wave and continuous wave systems in transmission, beat and other methods of reception, wired wireless, automatic printing, the buzzerphone and Fullerphone, will be given here.

### R500 APPLICATIONS OF RADIO.

To aviation, navigation, commerce, military, private and broadcasting, and the specific information under their headings, are referred to here.

### R600 RADIO STATIONS.

The operation, equipment, and management of radio installations, both transmitting and receiving, the testing, the rules and regulations concerning stations, the reports and bulletins issued, will follow under this heading.

### R700 RADIO MANUFACTURING.

Data relative to costs and contracts of radio equipment from raw material to finished product, including factories, tools, equipment, management, sales and advertising, follows here.

### R800 NON-RADIO SUBJECTS.

The matter of patents in general; the mathematics and physics, including chemistry, geology and geography; meters of various kinds; all information not strictly pertaining to radio, but correlated to this subject, will be found under this heading.

### R900 MISCELLANEOUS MATERIAL.

## A Key to Recent Radio Articles

R343. ELECTRON TUBE RECEIVING SETS. RECEIVER, *Radio-frequency*.  
RADIO BROADCAST. Sept. 1925, pp. 581-585.  
"An All-Wave Tuned Radio Frequency Receiver."  
Zeh Bouck.

To make broadcast reception possible from foreign as well as domestic stations, a receiver should be able to cover a band of from 200 to 2600 meters. Ordinary tapped inductances entail too great losses when used for wide wavelength ranges. By using the well-known honeycomb coils, the desired range can be obtained. The list of parts required, the circuit diagram and construction data is very completely given. A list of foreign broadcasting stations is appended.

R430. INTERFERENCE ELIMINATION. INTERFERENCE.  
RADIO BROADCAST. Sept. 1925, pp. 586-590.  
"When Broadcast Stations Interfere." C. B. Jolliffe.

The cause of so-called heterodyning of broadcast stations is explained by diagram and found to exist when broadcast stations deviate somewhat from their assigned frequencies. Some interference with programs broadcast from other stations is due to beat note produced when frequencies come too close together. The author describes how stations must constantly be checked by station operators and radio supervisors in the various government districts in order to maintain their assigned frequency.

R343. ELECTRON TUBE RECEIVING SETS. RECEIVER, *Super-pliodyne*.  
RADIO BROADCAST. Sept. 1925, pp. 620-622.  
"A Single-Control Receiver," C. L. Farrand.

A receiver, known as the super-pliodyne, is described, giving more detailed information on the operation and adjusting of the circuit, also described in July RADIO BROADCAST, pp. 387-392. Although a single control receiver, it gives just as great selectivity as a good super-heterodyne because the individual circuits are matched. The exact operation of this set, using a two-stage radio-frequency amplifier, is described technically, the circuit diagrams giving the necessary detail.

R375. DETECTORS AND RECTIFIERS. RECTIFIERS, *Tungar tube*.  
RADIO BROADCAST. Sept. 1925, pp. 640-650.  
"How to Make a Universal Battery Charger," Roland F. Beers.

The author reviews briefly the theory of a. c. rectification by various methods, and proceeds to describe the construction and operation of a tungar charger which can be used for a frequency range of from 25 to 70 cycles. Considerable detail in the assembly of this charger, parts required, and final instructions for operation, leave no opportunity for guesswork. Only 150 watts are consumed by this 2-ampere charger.

The 1925-26 Radio Dealer  
**YEAR BOOK**

a catalog of radio apparatus and trade  
marks now available to the trade

*at*

\$1.00 per copy, or

**FREE**

with One Year's subscription

*to*

**The RADIO DEALER,**

*the Pioneer Radio Trade Journal*



The Radio Dealer Publications

1133 Broadway

New York City

---

If you are in need of apparatus get in touch with our FREE Service Bureau



Howling and distortion both result frequently from running transformer leads too close together.

The case and brackets on B-T Euphonic Transformers are so designed to allow mounting in any position, on baseboard, sub-panel, or side—with the terminals always in position for short leads, and no crossed wires.

## B-T "Euphonic"— Pleasing to the Ear

More and more is popular judgment of radio directed toward quality. Fidelity to speech or music as given in the studio is the requirement of to-day.

Convinced that better audio transformers were necessary to secure the full benefit of B-T circuits and apparatus, B-T engineers tackled the transformer problem. The result of their long effort is the B-T Euphonic, a superior transformer. As its name implies it is "Pleasing to the Ear." We believe it the best audio transformer available to-day.

Ratio 2.2 to 1, Price, \$5.00 Ratio 4.7 to 1, Price, \$5.75

## Before You Buy Condensers —

No condenser is better than its bearings, and there is no bearing in radio that compares with the B-T "Lifetime."

Examine this feature before you buy.

The Straight Line Frequency type is illustrated. The 17-plate, .00035 is \$5.75. It covers 200 to 550 meters with Torostyle coils, giving absolute S. L. results.

The "LIFETIME" is also furnished in straight line wave length as well as Tandem.

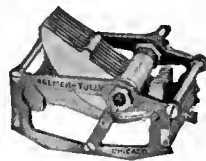

## The New B-T Set,—The Counterphase-Six

A B-T patented circuit with B-T parts and built in the B-T factories with typical B-T craftsmanship.

Six tubes, three stages of radio frequency enable it to receive distant stations with only a short indoor antenna. Only two tuning dials.

Write for full information



# BREMER-TULLY MFG. CO.

532 S. Canal Street

Chicago, Ill.

### R344. ELECTRON TUBE GENERATORS. OSCILLATOR, Modulated

RADIO BROADCAST. Sept. 1925, pp. 604-609.  
"What is to Become of the Home Constructor?" Keith Henney.

The radio field for the "home constructor" goes beyond mere set building if he is at all interested in the science of radio. In this article, RADIO BROADCAST makes the first attempt to bridge the gap between the larger scientific laboratories and the home workshop by guiding the constructor in the building and testing of apparatus for experimental purposes. The first instrument described is a modulated oscillator comprising a high frequency and a low frequency oscillator in one. Its construction is simple and can be used as an audio oscillator, radio oscillator, and modulated oscillator, for a variety of purposes.

### R385.5 MICROPHONES. MICROPHONE.

RADIO BROADCAST. Sept. 1925, pp. 612-615.  
"Microphone Placing in Studios." Carl Dreher.  
The microphone in a broadcasting studio is very sensitive to air vibrations and its proper operation and placing is quite important. How it is connected and set for receiving sound waves properly for transmission is explained and illustrated. Depending upon the type of musical instrument used, the microphone must be placed so as to receive a proportionate amount of sound energy. Blasting or reflection from walls causes distortion in the received wave.

### R582. TRANSMISSION OF PHOTOGRAPHS. PHOTOGRAPH TRANSMISSION.

Popular Radio. Aug. 1925, pp. 107-113.  
"Motion Pictures by Ether Waves." Charles Allen Herndon.  
The transmission of shadow pictures has been accomplished by C. Francis Jenkins. With his teloramophone, using four photo-electric cells and a rotating disc of lenses, he has been able to build up pictures at the rate of 15 per second and throw them on an illuminated screen, thus giving the effect of true moving pictures. The bulb used in bringing the pictures out clearly on the screen has a well of gas instead of the common filament. This light will go on and off instantaneously with the current. Photographs of the inventor and his machine in detail illustrate the system used.

### R360. ELECTRON TUBE RECEIVING SETS. RECEIVER, Grebe Synchronphase.

Popular Radio. Aug. 1925, pp. 116-127.  
"No. 7. The Grebe Synchronphase," S. Gordon Taylor.  
In this 7th of a series of articles, explaining the theory, operation, equipment and care of manufactured receivers, the Grebe synchronphase is discussed. This is a tuned radio frequency receiver of five tubes. The wiring diagram is shown complete, while the exterior and interior views of the set illustrate the placing of the various parts, including the "binocular" coils. The battery connections for the complete equipment, and the proper method of tuning, are described in detail. The receiver can be easily charted because the straight-line frequency condensers give equal spacing on the dials between stations.

### R376.3. LOUD SPEAKING REPRODUCERS. LOUD-SPEAKERS

Popular Radio. Aug. 1925, pp. 128-129.  
"A New Type of Hornless Loudspeaker," W. T. Meenam.  
A brief description of the operating principles of a new loud speaker, having several new features. A small paper cone is used as a horn, the field winding of the coil moving the voice-current coil is obtained from a d. c. source. A diagram of the working principles is given.

### R532. APPLICATION OF RADIO TO THE PRESS. PRESS.

RADIO BROADCAST. Sept. 1925, pp. 575-580.  
"Is the Radio Newspaper Next?" James C. Young.  
The effects of radio on newspaper work is felt not only in the matter of disseminating news, but also is becoming really a part of the press. In broadcasting happenings as soon as they occur, following a regular schedule, newspapers will likely change somewhat from their present practice of flashing news in glaring headlines and settle down to a practice similar to that of magazines. Some of the larger papers have installed their own stations both for transmission and reception of news, and the radio newspaper will before long become another of the many innovations of our present-day life.

### R480. RELAY SYSTEMS. PORTABLE STATIONS.

Popular Radio. Aug. 1925, pp. 130-135.  
"A Mobile Radio Relay Station." David Lay.  
The 63-meter mobile radio relay station of the A. H. Grebe Company, WGMU, is shown and described in detail. Fig. 5 represents the circuit diagram of the transmitter, Fig. 7 the microphone control. Photographs of the receiver and transmitter give an idea how relay stations pick up programs at remote points and relay them to the main station for rebroadcasting. This outfit is mounted in an automobile. It uses four 50-watt tubes as oscillators with a motor generator of 1500 volts furnishing the plate energy.

### R381. CONDENSERS. CONDENSERS.

Proceedings I. R. E. Aug. 1925, pp. 507-509.  
"The Straight-line Frequency Variable Condenser," H. C. Forbes.  
The equation for the shape of the rotary plates in a rotary variable condenser is developed so that the frequency-angular setting characteristic is a straight line. The equation for the capacity of this condenser at any angular setting is also given.

### R383.1. GRID LEAKS. GRID LEAKS.

Popular Radio. Aug. 1925, pp. 154-158.  
"Important Trifles in Radio: The Grid Leak," R. F. Yates.  
Though very insignificant physically, the grid leak is a very vital part in a receiver. Although of specific resistance when new its value changes considerably with age. The best kind of a grid leak would be a two-element vacuum tube with battery and rheostat connected as in Fig. 3. Several standard types of variable leaks are good when properly used.

# MUSIC MASTER SUPREME!

— as in Reproduction, so in Reception



Played, Sung or Spoken before the Microphone—

**B**ETWEEN broadcasting station and Music Master Reproducer stands MUSIC MASTER Receiver to bring in today's wonderful New Era super-program with splendid fidelity of effect and naturalness of tone.

Music Master Radio Receivers incorporate every demonstrated principle of standard radio reception and reproduction.

Music Master Receivers furnish radio reception equal in efficiency to the world-standard quality of radio reproduction achieved in Music Master Reproducer. Perfectly balanced radio reception and reproduction are thus available to discriminating radio lovers.

Ask any authorized dealer to demonstrate for you what clarity in reception may really be—what distance range is really available—what selectivity really means.

See MUSIC MASTER—hear—compare—before you buy any radio set.

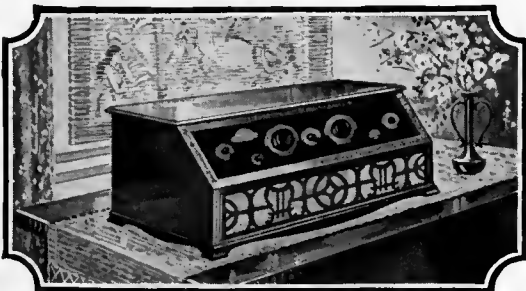

Music Master's Sensitive Mechanism Receives,

**TYPE 60**  
Five Tubes. Special Music Master design. Full, round, natural tone. Three selectors for precise tuning. Without equipment..... \$60



Endures with Power, Clarity and Volume.

Ten Models—\$50 to \$460—Unconditionally Guaranteed



Music Master Resonant Wood Insures Natural Tone Quality



**TYPE 100**  
Five Tubes. Resonant reproduction. Exceptional range. Massive mahogany console cabinet. "B" battery compartments in cabinet. Without equipment..... \$100

**Music Master Corporation** ★

Makers and Distributors of High-Grade Radio Apparatus

CHICAGO NEW YORK PHILADELPHIA PITTSBURGH MONTREAL  
Canadian Factory: Kitchener, Ontario

**MUSIC**  **MASTER**  
RADIO PRODUCTS

# "As efficient as Radion Panels"

*The best recommendation for  
these Radion low-loss parts*



THE very latest developments in radio are embodied in the complete line of Radion low-loss parts—moulded of Radion, the insulation made to order for radio purposes exclusively.

Leading set manufacturers and thousands of amateurs know by experience that Radion Panels are most effective in reducing surface leakage and leakage noises. This means lowest losses and greater efficiency, especially noticeable in super-sensitive circuits. All the Radion low-loss parts have the same high-resistant characteristics of Radion Panels.

You can now get Radion Sockets, Dials, the new Radion Loud Speaker Horn, Tubing, Binding Posts, Strips, Insulators, etc. Radion Panels in black and Mahoganite come cut in standard sizes for whatever set you wish to build.

Send for booklet, "Building Your Own Set." Gives wiring diagrams, front and rear views, shows new set with slanting panel, lists of parts and directions for building popular circuits. Mailed for 10 cents.

AMERICAN HARD RUBBER CO.  
Dept. C-11, 11 Mercer St., New York City

AMERICAN HARD RUBBER COMPANY  
Dept C11, 11 Mercer St., New York City

Please send me your booklet, "Building Your Own Set," for which I enclose 10 cents in stamps.

Name \_\_\_\_\_

Address \_\_\_\_\_

## NEW!

Practical types of low-loss Radion sockets for the new tubes and a collar adapter, if you like, for the old style bayonet type tube.

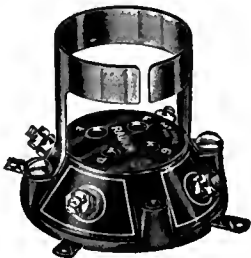

No. 2 Socket for new UX tubes with collar adapter for old type tubes. No. 3 same as No. 2 without binding posts.



No. 4 Sockets for new UX tubes. No. 5 same as No. 4 without binding posts.

# RADION

*The Supreme Insulation*

*Made to order for radio  
purposes exclusively*

R343. ELECTRON TUBE RECEIVING SETS. RECEIVER.  
*Radio.* Aug. 1925, pp. 35ff. 5-100 meters.  
"A 5 to 100 Meter Radio Receiver," D. B. McGown.  
For high frequency telegraph reception the simple regenerative feedback circuit gives very good results. The construction and operation of such a receiver is delicate and must be done properly. A series of coils are necessary to cover the band of frequencies. The construction data include number of turns, diameter and approximate wave length covered by coils, and method of mounting.

R343. ELECTRON TUBE RECEIVING SETS. RECEIVER.  
*QST.* Aug. 1925, pp. 11-14. 15-200 meters.  
"Plug-in-Coil Receivers," John M. Clayton.  
A short wave receiver covering the present amateur bands within 15-200 meters must have rapidly interchangeable coils to be of any value in good operation. Space wound plug-in coils of various sizes serve the purpose well. The views of circuit diagrams and receiver show the arrangement of parts, and data for constructing the coils is given. General Radio coils of the plug-in type can be used also. The two receivers described make use of either the manufactured coils or the home made ones. Both receivers are one-tube sets; amplifiers can be added.

R369. ELECTRON TUBE RECEIVING SETS. RECEIVER.  
*QST.* Aug. 1925, pp. 16-19. DeForest D-17.  
"The DeForest D-17 Receiver," E. A. Livingstone.  
This receiver is a five-tube reflex set covering a band from 220 to 550 meters. The circuit diagram is shown complete, also internal views of the finished receiver. The data covering the set is very complete, even giving size of condensers, transformer ratios and gauge of wire used in them, and their characteristics, including those of the remaining parts of the instrument. Real information for the owner of one of these receivers.

R342.15 AMPLIFIER TRANSFORMER. TRANSFORMERS.  
*QST.* Aug. 1925, pp. 24-25. Voltage ratio.  
"Measurement of Voltage Ratio of Audio and R. F. Transformers," R. R. Ramsey.  
The article presents a mathematical discussion of audio and radio frequency transformer-ratios and how to measure them. The application of the method outlined is applied to the neutrodyne circuit in the case of radio-frequency transformers.

R355. HIGH-VOLTAGE GENERATORS. GENERATORS.  
*QST.* Aug. 1925, pp. 26-27.  
"The Bowdoin's Generators," E. W. Berry.  
A new type of generator built by the Electrical Specialty Company has been designed for use on the ship *Bowdoin*. This machine gives almost a perfect sine wave, excellent commutation and has a greater capacity to size than former types, due to material changes made in field construction and winding. It is also remarkably free from ripple effects.

R386. FILTERS. FILTER CIRCUIT.  
*QST.* Aug. 1925, pp. 33-34.  
"Smoothing Circuits for Half-Wave Rectification," F. S. Dellenbaugh, jr.  
In smoothing out rectified a. c. voltage for plate supply, both capacity and inductance must be used in order to obtain steady output. What effect mere inductance or capacity will have, and how the combination is used to best advantage, is simply explained in this discussion and illustrated with diagrams.

R240. RESISTANCE; DECREMENT; PHASE DIFFERENCE; POWER LOSS. LOSSES IN APPARATUS.  
*QST.* Aug. 1925, pp. 37-38.  
"Loss Comparisons," W. L. Seibert.  
In the discussion, the author describes a convenient method of comparing losses in variable air condensers and other parts of radio frequency receiving circuits. By this scheme, using a standard one-tube receiving circuit, other instruments may be compared, so that the best apparatus can be selected for radio purposes. It is a very simple method and can be applied in any experimenter's work-shop.

R800 (535.3). PHOTO-ELECTRIC PHENOMENA. SELENIUM CELLS.  
*Radio Engineering.* July, 1925, pp. 346-349.  
"Selenium and Photo-Electric Cells," Samuel Wein.  
Selenium was discovered about 100 years ago. It is found in various minerals as listed in this discussion. How it is extracted, the amount annually produced, the methods used in purification, and its chemical and physical characteristics are given in detail. Just as it was discovered by accident, so also the fact that its light sensitivity is very great was determined accidentally. A non-conductor of electricity when not subjected to light, its conductivity is materially great when light waves strike it, the difference being from 15 to 20 per cent. A list of references to other authors on the subject is appended.

R800 (535.3). PHOTO-ELECTRIC PHENOMENA. SELENIUM CELLS.  
*Radio Engineering.* July, 1925, pp. 390-392.  
"Selenium and Photo-Electric Cells," Samuel Wein.  
In this second chapter on Selenium Cells, Mr. Wein discusses the essentials of their construction, and the various forms of cells used to-day. The methods employed in fixing the selenium to the conducting wires is simple yet delicate. The seven diagrams show the various types of cells which have been made and used in experimental laboratories. A list of references to other articles on the subject is appended.

R333. ELECTRON TUBES; THREE ELECTRODE. TUBES, AC. RECEIVING.  
*Radio.* Aug. 1925, pp. 17ff.  
"Principles of Alternating Current Tubes," E. E. Turner.  
A tube for receiving sets operating on alternating current for both filament and plate supply, has been designed and is destined to relieve the listener of the troublesome wet cell batteries. The tube has been developed by the General Electric Company and its operating features are illustrated in the article. The A. C. hum has been practically eliminated by the use of filter-systems in the plate circuit. The electron emission is obtained through indirect heating of an oxide coated cylinder. This tube is by no means perfected, but represents a step in the right direction.

# EASTERN pickle bottle COILS Supreme!

REG. U.S. PAT. OFF.

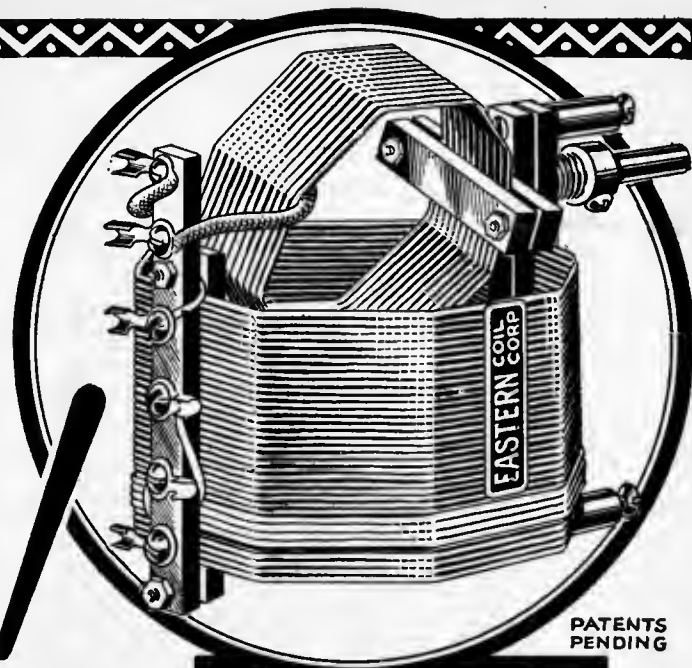

PATENTS PENDING

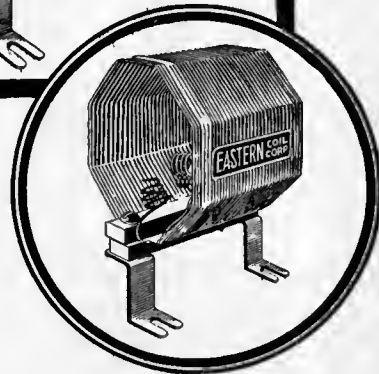
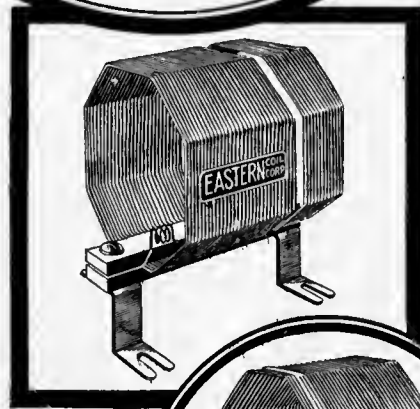

Endorsed by  
*Radio  
Broadcast*

**R**EALIZE the best possible results from your circuit.  
Do not be satisfied with less!

The utmost efficiency obtainable from your set is guaranteed in using Eastern Pickle Bottle Coils because they represent the greatest advance in low loss coil design, and are *the most efficient coils it is possible to make.*

In Eastern Pickle Bottle Coils dielectric losses are negligible. All wires are kept free of any collodion or other injurious substance. They have less insulating material in the field than any other type of coil, and are designed with a view to mechanical and electrical perfection in every detail.

Elimination of losses keeps the high frequency resistance at the minimum, insuring increased selectivity, volume, and natural tone quality.

## EASTERN KNOCKOUT COILS (TYPE R)

are designed and guaranteed for perfect performance in any Radio Broadcast Roberts Knockout Circuit (reflexed or non-reflexed). Minimum of capacity between N. P. winding and secondary; mid-tap on single-wound N. P. coil—makes it easy to neutralize and tune, and brings in the lower wave length stations as never before. Price . . . . . **\$8.50** per set

### EASTERN PICKLE BOTTLE COILS ARE ALSO DESIGNED FOR THE

- BROWNING-DRAKE Circuit (Type B-D) Price \$8.00 per set
- DX SUPERDYNE (Type S) \$8.00 per set
- RX-1, the new revolutionary M. B. Sleeper Circuit (Type RX-1 coils) \$6.00 per set
- O'CONNOR FREQUENCY CHANGER  
A one-tube outfit which converts any set into a super-heterodyne (Type F C Coupler) \$6.00
- TUNED R. F. Circuits  
(Type A) For .0005 condensers;  
(Type B) For .00035 condensers \$2.00 per coil
- THREE CIRCUIT SET (Eastern Low Loss Coupler)  
Broadcast Wave (Type 3C) 200-600 meter \$6.00  
Medium Wave (Type M3C) 60-240 meter \$6.00  
Low Wave (Type L3C) 19.7-81 meters \$6.00

At your dealer's or direct, postpaid

## EASTERN COIL CORPORATION

22 Warren Street Department R. B. New York

# Striking Lines and Vigorous Proportions

New and Improved  
**FRESHMAN  
MASTERPIECE**



## The FRANKLIN CONSOLE

is a dignified piece of furniture, built entirely of carefully selected five-ply genuine mahogany in a two-tone effect of soft and alluring beauty.

*It Is Composed of Two Separate and Distinct Units*

- [1] the actual receiving set with built-in loud speaker.
- [2] the console cabinet with compartments for batteries, eliminator, charger and other accessories, not a single wire being visible.

*Write for illustrated booklet (in seven colors) describing our entire line of radio receivers.*

For Sale by Authorized FRESHMAN DEALERS Only

**Chas. Freshman Co. Inc.**  
*Radio Receivers and Parts*  
FRESHMAN BUILDING  
240-248 WEST 40TH ST.—NEW YORK, N.Y.  
CHICAGO, 2626 W. Wash'n. Boulevard  
Prices slightly higher Denver and West

**\$75.**

Complete  
with Console  
Table  
as Illustrated

**\$115**

The  
World's  
Greatest  
Radio  
Receiver

R800 (537.65) PIEZO-ELECTRIC PHENOMENA. CRYSTALS. Piezo-electric.

*Radio News.* Aug. 1925, pp. 142ff.

"The Piezo-Electric Oscillograph," C. B. Bazzoni.

When current passes through a circuit certain effects are observed, known primarily as thermo-electric, Seebeck, Peltier, Thompson, Nerst, Hall, Leduc, and others which are of interest. These effects are explained briefly. Electric currents may also be produced with the aid of crystals. Two effects, the pyro-electric and piezo-electric, are of special interest in the study of crystals, and are described. Because of the piezo-electric effect, oscillographs may be constructed with very little cost, which, when suitably mounted, record frequencies up to 5000 cycles. The Rochelle salt crystals can easily be made with the aid of the information given. Other uses for the oscillograph suggest themselves after the apparatus has been constructed and used.

R381. CONDENSERS.

CONDENSERS.

*Radio News.* Aug. 1925, pp. 188ff.

"Straight-Line Frequency Condensers," Sylvan Harris.

A detailed discussion covering straight-line wavelength, capacity, and frequency condensers and how they are mathematically designed and constructed. The curves show the comparison of the three types of condensers, dial-setting vs. kilocycles. Since broadcasting stations are separated according to kilocycles, this frequency should form the basis for condenser construction. All stations would then be equally separated on the dial. The article is very complete, in illustrations as well as information.

R420. CONTINUOUS WAVE SYSTEMS.

TRANSMITTERS

100-200 m.

*Proceedings I. R. E.* Aug. 1925, pp. 413-436

"Recent Commercial Development in Short Wave-Transmitters and Receivers," by S. E. Anderson, L. M. Clement, and G. C. DeCoutouly.

This paper describes the transmitter and receiver recently developed for use by the United States Coast Guard. This apparatus is for operation on wavelengths between 100 and 200 meters. A short summary of the various circuit considerations is included. The actual transmitter finally developed is also described together with its operating characteristics. In considering the radio receiver, the various problems to be met in the design of a radio receiver of this character are dealt with at some length. The frequency characteristics of the radio receiver, as developed, are shown, and the method of determining them is described in detail. The transmitter and receiver performed very satisfactorily under conditions considerably more severe than will be met in actual service.

R376.3. LOUD-SPEAKING REPRODUCERS.

LOUD-SPEAKERS.

*Proceedings I. R. E.* Aug. 1925, pp. 437-460.

"Design of Telephone Receivers for Loud-Speaking Purposes," C. R. Hanna.

A discussion of the advantages and disadvantages of various present day electro-magnetic receivers is given in a mathematical outline. A new type, called the balanced diaphragm receiver, is described and the details of design worked out. The experimental work includes resistance and reactance curves and a verification of the theory covering the design.

R387.1. SHIELDS.

SHIELDING.

*Proceedings I. R. E.* Aug. 1925, pp. 477-505.

"The Shielding of Electric and Magnetic Fields,"

J. H. Morecroft, A. Turner.

An experimental investigation of the shielding of electric and magnetic fields is reported, for both constant and changing fields.

The effect of using iron shells, or sheets, for shielding against the fields of permanent magnets, as well as those set up by electric currents, is considered; the best form for the iron sheets is deduced and an expression for a measure of the shielding action suggested.

The reason for the leakage of magnetic and electric fields is shown to be due to differences of magnetic or electric potentials in the circuit in which the fluxes are being set up; several cases are cited in which no external fields are set up, as the circuits exhibit no differences in potential.

An expression for the shielding effect of a short-circuited coil is deduced and experimental verification is offered for frequencies between  $10^2$  and  $10^6$  cycles per second.

Finally the shielding effect of metal sheets against changing magnetic fields is analyzed, and experimental results are given to show how the action depends upon the characteristics of the material of which the shielding plate is made, its thickness, and upon the frequency used. The effect of slits in the metal sheet, and the value of wire mesh, is indicated.

R235. MUTUAL INDUCTANCE.

MUTUAL

INDUCTANCE.

*Proceedings I. R. E.* Aug. 1925, pp. 511-512.

"Calculation of the Mutual Inductance of Co-axial Cylindrical Coils of Small Radial Depth," F. B. Vogdes.

This article shows how the mutual inductance of co-axial cylindrical coils of small radial depth may readily be obtained by the use of curves of a type recently described by the United States Bureau of Standards. These curves cover the mutual inductance between coaxial circles, and by a very simple process of summation their usefulness can be extended to coils of small radial depth.

R343. ELECTRON TUBE RECEIVERS. SUPER-HETERODYNE, Radio. Aug. 1925, pp. 111f.

"The Modified Best Super-heterodyne," G. M. Best.

The Best Super-heterodyne has been redesigned by the author to cover wavelengths from 40 to 580 meters. In this first article a shielded model using dry cell tubes is described. Three controls are needed. The oscillator coil can be removed and exchanged for one covering a different band of frequencies. A complete description of construction and operation is given, including diagrams and panel layouts.

R142. COUPLED CIRCUITS.

COUPLING.

*Radio.* Aug. 1925, pp. 30 ff.

"Coupling," L. R. Felder.

How energy is transferred from one circuit to another is discussed by the author in an elementary way. Resistance, inductance and capacity coupling are taken up in turn and explained with the aid of diagrams.



# KODEL RADIO

The Emblem of  Worth in Radio

## The Best that Radio Offers



**LOG·O·DYNE** \$90<sup>00</sup>  
"BIG FIVE"

*Five tubes, self-balanced tuned radio frequency; sloping panel gold engraved; beautiful, massive, Adam brown mahogany cabinet; compartment for batteries; stations already logged for easy tuning.*

If the LOGODYNE Big Five excelled only in performance it would not be a KODEL RADIO.

But combining as it does the ultimate in good performance, a tone as mellow and true as a rare old music instrument, a cabinet artistry worthy of the old masters the LOGODYNE Big Five expresses the perfection required of the entire KODEL RADIO line—the best that radio offers.

**Free** Send for the new edition of our free booklet "The Secret of Distance and Volume in Radio". Gives helpful interesting information on radio operation.

**THE KODEL RADIO CORPORATION**  
505 East Pearl Street Cincinnati, Ohio



LOGODYNE "Big Five" Console Model—the Aristocrat of Radio; built-in loud speaker; compartment for batteries and charger a masterpiece in furniture design. \$275



LOGODYNE "Standard Five" Console Model—beautiful brown mahogany; built-in loud speaker; compartment for A and B batteries and charger..... \$165



LOGODYNE "Standard Five"—five tubes self-balanced tuned radio frequency; gold engraved panel and sub-panel; battery compartment; handsome brown mahogany cabinet..... \$70

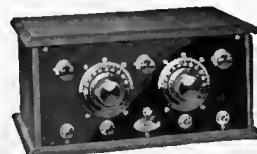

KODEL "Gold Star" Models—Radio's greatest set values;  
Three Tube "Gold Star" Model. \$30  
Two Tube "Gold Star" Model.. \$20  
One Tube "Gold Star" Model... \$12  
"Gold Star" Crystal Set..... \$ 6



# Announcing

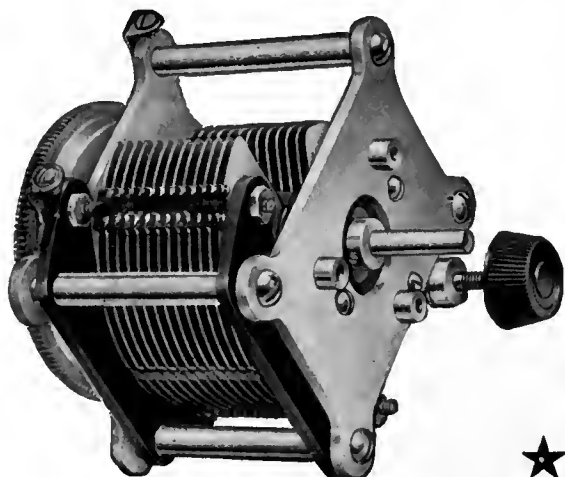

## the New Type 334

# GENERAL RADIO

## Straightline Wavelength Condenser

In certain instances of radio construction the shielding effect of a metal end plate condenser is particularly desirable.

To meet the popular demand for this type of condenser the new type 334 has been developed and is now available at popular prices in all standard capacities both with and without vernier.

In designing these condensers points that have been stressed particularly are ruggedness, permanence of calibration, and uniformity between individual condensers of the same capacity.

These are the factors so essential to the successful operation of modern radio sets.

Rotor and Stator units are similar to those used in the well known type 247 condensers and good interplate conductivity is assured through solder-sealed contacts.

All General Radio condensers are rigidly inspected before leaving the factory and are thoroughly guaranteed electrically and mechanically.

With Vernier			With Counterweight		
Type	Capacity	Price	Type	Capacity	Price
334-H	.0005 MF.	\$5.25	334-F	.0005 MF.	\$4.25
334-P	.00035 MF.	5.00	334-N	.00035 MF.	4.00
334-M	.00025 MF.	4.75	334-K	.00025 MF.	3.75

Ask to see them at your local dealer's  
or write for our new Catalog 922-B.

**GENERAL RADIO Co.**

**Cambridge, Mass.**

R402. SHORT WAVE SYSTEMS. SHORT WAVE STATIONS.  
*Radio.* Aug. 1925, pp. 10ff.  
"Short Wave Work at Naval Research Laboratory," S. R. Winters.

Tests on 20 meters have shown that great distances can be spanned with comparatively low power transmitters. This fact has been established at the Naval Research Laboratory under the supervision of Dr. A. H. Taylor. With the transmitter, receiver and antenna as illustrated, communication was carried on with stations in England and Australia.

R210. FREQUENCY; WAVELENGTH. KILOCYCLES.  
*Radio.* Aug. 1925, pp. 24ff.

"Ideal Tuning in Kilocycles," E. E. Griffin.  
The advantages of using kilocycles in preference to wavelengths are many. With a more general use of the term, kilocycle, eventually all apparatus will be constructed on this new basis. Using frequency designation simplifies tuning and leads to clear understanding of the principles involved. The author illustrates this point very clearly. Since most receivers use a variable condenser in tuning, it is of course desirable to employ a condenser of the straight line frequency type, not straight line wavelength or straight line capacity as shown.

R162. SELECTIVITY IN RECEIVERS. SELECTIVITY.  
*Radio.* Aug. 1925, pp. 27ff.

"Selectivity Versus Distortion in a Super-heterodyne," J. E. Anderson.  
A minute analysis of the part that the intermediate filter plays in a super-heterodyne is given. What frequency ratios are best in obtaining all-around good results when tuning in on certain stations can best be determined by using some definite intermediate frequency to which the filter is tuned, and determining by illustration what beat notes are set up. This the author brings out very clearly. Since selectivity and distortion increase with a lowering in frequency for the filter circuits, some value must be chosen which gives the minimum for both. Curves showing the distortion ratios illustrate the points discussed. By proper selection of audio frequency transformers much of the distortion introduced through the filter circuit can be eliminated.

R343. ELECTRON TUBE RECEIVING SETS. RECEIVERS.  
*Radio.* Aug. 1925, pp. 20ff.

"More Miles to the Dollar," V. G. Mathison.  
Directions are given for the construction of a cheap and selective three-tube Browning-Drake receiver, employing several novel modifications in coil construction and arrangement. Diagrams of winding and setting complete the information.

## The Winner of Our \$500 Prize Cover Contest

OUR new cover, which, as the reader will readily see, is an entirely distinct departure from anything else we have heretofore done in this respect, and is the design of Mr. Fred J. Edgars of Tenafly, New Jersey. Out of nearly a hundred cover designs submitted, his was chosen by the judges as being the most original and generally attractive.

Mr. Edgars was born in Dover, a seaport on the southeast coast of England, and is descended from a long line of artisans and shipbuilders. Very early in life he felt the urge to paint, and in fact, sold his first landscape when only nine years old. After this he spent some time studying at Kensington, in London, and was able there to develop fully his desire to paint subjects from nature and other natural subjects. Mr. Edgars is probably more American than English now, for he has been in this country for more than forty years, since 1881. He spent a number of years doing theatrical scenery painting and was very successful at this, but later branched out into doing illustration work for national advertisers. He has been employed in this branch of creative work for some twenty years now.



MR. FRED J. EDGARS

Throughout all his painting he strives to use the colorful effects of natural subjects and is largely inspired by the many flowers which bloom in his garden, a view of which is obtained through his studio window. His hobbies are carpentry and farming.



*No Cracking* ★

*No Chipping*

**D**RILL and machine the Goodrich Silvertown Radio Panel with full confidence—no special tools are required—it won't break at the edge, crack or chip.

It is made with a full degree of Goodrich skill and rubber knowledge, after long study of radio requirements—the product of a company that has always held quality and service as first considerations.

Science says that rubber is the best material for panels. Then by all means buy the best rubber panel—and that brings you straight to Goodrich Silvertown.

Fifty-five years of rubber manufacturing experience are a guarantee of greatest efficiency in the following products Goodrich has built for radio—

Goodrich V. T. Sockets      Spaghetti Tubing  
Goodrich Variometers      Unwound Battery Mats  
Goodrich Radiophone Ear Cushions

The B. F. Goodrich Rubber Company  
Established 1870      Akron, Ohio

- 1 Easier to drill and machine.
- 2 Better color, lasting luster.
- 3 Lower free sulphur—no discoloration.
- 4 Higher softening point—no warping.

**Goodrich**  
**Silvertown**  
*The Radio Panel Supreme!*

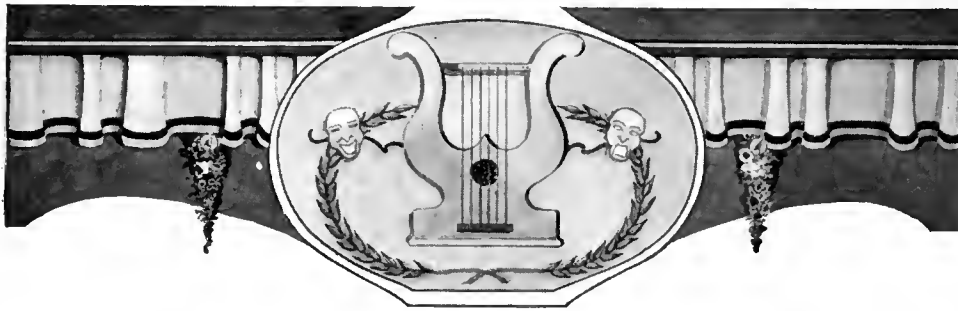

## Fifty Years for Stability

Discriminating people must have assurance of unquestioned stability back of every piece of merchandise they purchase.

This year, the fiftieth anniversary of the Holtzer-Cabot Electric Company, is an opportune time to bring before the radio public a medium priced loud speaker that is unsurpassed by any other at, or near its price.

This loud speaker is on sale at dealers who are most jealous of their reputation.

Insist upon hearing it.

**National  
Loud Speaker**

**\$12.00**

*Adjustable Control*



1875-1925  
For  
**FIFTY  
YEARS**  
manufacturers  
of  
*Quality  
Electrical  
Apparatus*

The  
**HOLTZER-CABOT  
ELECTRIC CO.**  
125 Amory St.,  
Boston, Mass.



## FROST-RADIO

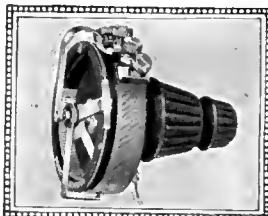

**TUBE ★  
CONTROL  
UNIT**

**\$1.75**

(6, 25 or 35 ohms)

COMBINES Vernier Rheostat and Potentiometer. Single hole mounting. 6, 25 or 35 ohm rheostat, 400 Potentiometer. Genuine Moulded Bakelite. List: \$1.75. Pacific Coast price slightly higher.



**HERBERT H. FROST, Inc.**  
314-324 WEST SUPERIOR STREET, CHICAGO  
New York City Cleveland Kansas City Los Angeles

## How to Eliminate Local Interference

### Part I

#### How the Interference Originating in Electrical Apparatus Reaches Your Radio Receiver

FOR the past year, the Research Council of Canada, on behalf of the Department of Marine and Fisheries, has been conducting an investigation into the cause of and means of locating and suppressing radio inductive interference. This series of articles, of which this is the first, is reprinted from an excellent little pamphlet, published by the Radio Branch of the Department of Marine and Fisheries of the Dominion of Canada Government. The book is entitled "Radio Inductive Interference, Bulletin Number 1." Many of the suggestions contained in this series have not been offered in other quarters, and we are sure that radio listeners who have been cursed with artificial interference of one sort or another will welcome the help this series offers.

—THE EDITOR.



#### HOW THE INTERFERENCE ORIGINATING IN ELECTRICAL APPARATUS REACHES YOUR RADIO RECEIVER

ALL electrical conductors carrying current are surrounded by an electromagnetic field. When the current in a conductor changes, the electromagnetic field also changes in a similar way and will induce a voltage in any radio receiving antenna close to it.

There is also another field, called the electrostatic field, surrounding all electric conductors at high voltage. A change in this electrostatic field also induces a voltage in the antenna of any radio receiver which is close to the power wires.

Under normal operating conditions on electric power lines, this electromagnetic and electrostatic field which surrounds the conductors does not extend more than a few yards from the power line. In some cases, however, where the change of current or the change of voltage is of a very sudden nature, called an electrical surge, a radio receiving antenna situated at a considerable distance from the power line may be affected. An electrical surge may travel many miles along a power line, and produce a radiation which may be picked up on radio receivers.

In cases where it is not practicable to get far enough away from the power lines, the antenna should be run as nearly as possible in a direction at right angles to the power line, as the induction from power lines is very much greater on antennas which run parallel to them.

In no case should an antenna be erected above a power wire in such a way that it would be possible for it to come in contact with the power wire in case it should accidentally fall. Many accidents have been caused in the past by antennas accidentally coming in contact with power wires.

#### CHARACTERISTICS OF RADIO INDUCTIVE INTERFERENCE

THE following characteristics of the radio inductive interference from some sources may provide useful clues in the investigation.

1. *Battery chargers of the vibrator type* cause an electrical surge which may travel along the supply wires of the secondary distribution system and cause radio interference to all receivers near these wires. This interference is very staccato in character and consists of a regular series of clicks corresponding to the frequency

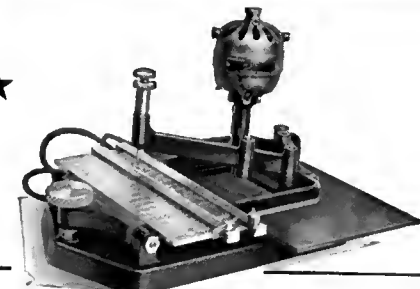

### Rapid Engraving Machine For Engraving Radio Panels

*Easy to operate. Will increase Radio Dealers income*  
A low price engraving equipment for engraving the words used on radio panels, trade-marks, and border and corner designs. Will engrave on Hard Rubber, Bakelite, Aluminum, and other soft metals. Price of complete equipment, \$135.00.

*Will earn several dollars an hour engraving panels for amateurs building their own sets.*  
Branch Tool Co., Dept. G, Forestdale, R. I.



# The real solution to the tuning problem!



**M**AKE your radio a 1926 model. Replace your present Dials with Rathbun Straight Line Frequency Converters which spread all stations within the range of your receiver uniformly around the whole circle of 360°. All stations are a uniform distance apart on these new Converters which is the ideal tuning condition.

Why be satisfied with Dials or Condensers which are limited to 180° or only half the dial? Why stop at 180° when there are 360° in the circle? No gears with their back lash, no friction with its slippage in Rathbun Straight Line Frequency Converters—only two moving parts, a variable cam and a lever. Easily and quickly installed on any set—it is not necessary to cut Condenser shaft or drill panels.

The Rathbun Straight Line Frequency Converter is one of the few really new things in radio during the past three years.

Don't forget that we build the Rathbun Single Hole Mounting Condenser with genuine Bakelite ends. This year's models are all enclosed with transparent pyralin dust bands which preserve their high efficiency for life. Small, light, rugged, handsome and none lower loss or higher in efficiency. Always reasonably priced.

Ask your dealer for Rathbun Straight Line Frequency Converters. If he has not yet stocked them, he will quickly obtain them

**PRICE \$3.50**

**Rathbun  
Manufacturing Co., Inc.  
Jamestown, New York**

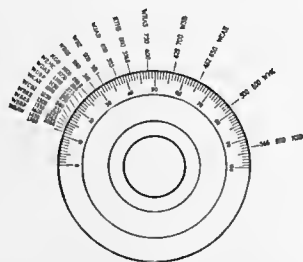

Stations indicated in kilocycles and wave lengths showing crowding with an ordinary capacity condenser

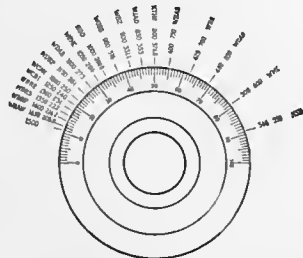

Stations partially separated and tuning slightly improved with a Straight Line Wave Length Condenser

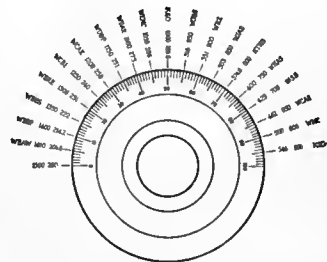

Practically even separation over half the dial with a Straight Line Frequency Condenser

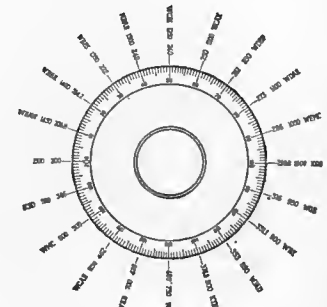

Complete and equal separation of stations over the entire dial with the Rathbun Straight Line Frequency Converter



**J**OT down the call letters in the handy slot—right on the dial itself—and there is your permanent record of the dial settings.

## The One Dial That's All a Dial Should Be

You'll never know how much difference a dial can make until you actually get your hands on the new Mar-Co. It splits a single degree into hair's breadth divisions. It responds to your slightest touch with no suggestion of backlash.

Smooth—precise—and strikingly handsome—built for your present set and for your next year's set as well—it is what you'd expect of Mar-Co—see it at your dealer's.

NICKEL PLATED \$2.50

GOLD PLATED \$3.00

*Clockwise or Counter-Clockwise Action*

MARTIN-COPELAND CO., Providence, R. I.

# MAR-CO Vernier Dial



22½ Volt  
un-acid  
everlasting  
rechargeable  
"B"

Storage Battery

\$2.95

including  
chemical

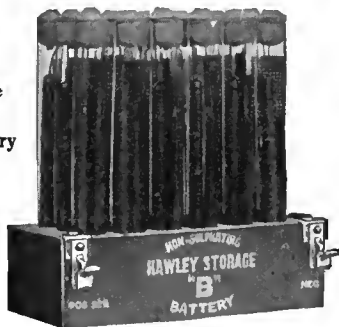

Does not lose charge standing idle. SPECIAL—2 2 2 ½ (45 volts) \$5.25; 90 volts \$10.00. Any special detector or amplifying voltage easily had. Very easily charged. Nearly 3 years sold on a non-red tape 30 day trial offer with complete refund if not thoroughly satisfied. Further guaranteed 2 years. Knock-down kits at still greater savings. Complete ready to run "B" battery charger \$2.75. Sample cell 35c. Order direct—send no money—simply pay expressman when delivered, or write for my free literature, testimonials, and guarantee. My large 36-page radio goods catalogue 10c. Same day shipments.

B. F. SMITH, 31 Washington Ave., Danbury, Conn.

## M & M Low Loss INSULATORS

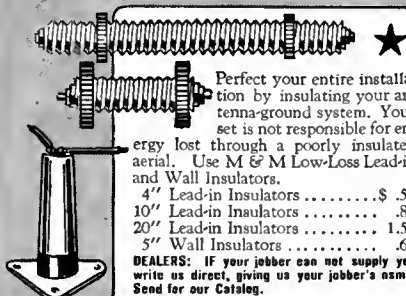

Perfect your entire installation by insulating your antenna-ground system. Your set is not responsible for energy lost through a poorly insulated aerial. Use M & M Low-Loss Lead-in and Wall Insulators.

4" Lead-in Insulators ..... \$ .50  
10" Lead-in Insulators ..... .80  
20" Lead-in Insulators ..... 1.50  
5" Wall Insulators ..... .60

DEALERS: If your jobber can not supply you write us direct, giving us your jobber's name. Send for our Catalog.

The M & M Co.  
CLEVELAND, OHIO.

of the alternating current supplying the charger.

2. *Commutator motors* in some cases cause radio interference due to sparking of the brushes, and may often be recognized by the sound in the radio receiver. The interference noise will rise in pitch as the motor speeds up. In cases of motors running at less than 300 revolutions per minute it is sometimes possible to count the speed of the motor by listening to the radio receiver and observing the second hand of a watch.

With practice an observer may learn to count much higher speeds by listening to the run of the sounds by fours and counting only the beginning of each group of four. To acquire this ability it is suggested that at first the hand be moved down at the beginning of each group, and when this can be done easily the motions of the hand may be counted.

### FAULTS OF HIGH VOLTAGE LINES

A *FAULTY insulator* on a transmission line of 30,000 volts or more may sometimes cause an electrical surge which travels along the transmission line for many miles and causes radio interference to receivers situated within a few hundred yards of this line. This radio interference may be induced into other lines which run parallel to it and thus be distributed over a wide area, possibly throughout the entire city. This interference is usually continuous, but may under some conditions be intermittent and very erratic. The number of cases of such interference, however, is very small, as faulty insulators usually cause the shut down of the transmission line for repair.

4. *A transmission line* which sparks to some insulated conductor, such as an insulated guy wire or an ungrounded conduit, may cause radio interference of a similar nature to that described as originating on a faulty insulator. In this case, however, the interference may continue for weeks or months without causing any power shut down, as the amount of current flowing is only sufficient to charge the ungrounded metal and not sufficient to indicate at the power house. In case such a fault is caused by a line swinging into contact with a guy wire, it is usually noticed to be intermittent during windy weather.

### FAULTS IN TRANSFORMERS

**I**NTERFERENCE which is caused by defective insulation in conduit or in electrical apparatus, is sometimes intermittent and comes on when the apparatus is vibrated or subjected to strain by expansion due to a change of temperature. For example: A faulty bushing on the primary of the transformer may cause radio interference by sparking to the ungrounded frame of the transformer when the transformer is subjected to vibration by the passing of a truck along the road.

Transformers which produce an audible hum do not necessarily cause radio interference, as this hum is usually produced by the vibration of the laminations of the core.

6. *Charging of lightning arresters* is heard in the radio receiver as a very loud roar, but only lasts for a few seconds. Sometimes this is repeated a number of times as a series of lightning arresters are charged at one station. Most power companies charge their arresters at times outside the broadcasting period, such as noon or 2:00 or 3:00 o'clock in the morning. The interference from lightning arresters may be heard for many miles from the source.

7. *Cottrell Precipitators* sometimes cause radio interference which may be heard at a distance of 15 miles, but when proper means are taken to reduce this interference at its source they cannot be heard at a distance of more than one mile.



Radio Receiver



# Radio evenings are complete If you have a Valleytone

### Appearance

The Valleytone is mounted in a solid walnut cabinet, finished in two tones with inlaid gold stripes. It may also be procured in beautiful console models. Special Valley tables with built-in loud speaker may be obtained for the cabinet model.

Valleytone Console Model

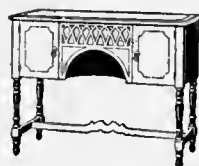
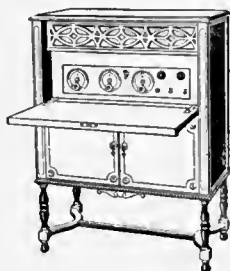

Valley table with built-in loud speaker

You can always count on a full evening's entertainment if you have a Valleytone Radio Receiving Set.

Music with your dinner . . . bedtime stories for the children . . . a play, an opera, or a concert . . . jazz, mammy songs, spirituals . . . the whole range of radio broadcasting can be yours.

With the Valleytone, you can choose your programs by the clock and hear them all the evening through.

For the Valleytone is selective. It will separate and bring in stations only four or five meters apart and will easily separate local and distant stations.

Valleytone selectivity gives a new meaning and puts a new pleasure in radio.

And with the balanced tone of the Valleytone when you hear a station you marvel that any reproducing mechanism can really achieve such faithfulness and such natural results.

The superiority of the Valleytone can be demonstrated. The Valleytone thrives on comparison. Wherever it is judged by results and performance, it wins a new owner.

Any authorized dealer will be glad to demonstrate the Valleytone for you.

VALLEY ELECTRIC COMPANY, Radio Division, ST. LOUIS, U.S.A.  
Branches in Principal Cities

Valleytone Receiving Sets

Valley Battery Chargers

Valley B-Eliminators



# Valley Electric

# ANOTHER RADIO TRIUMPH

## BRACH

# PUR-A-TONE AUDIO COUPLER

### An Improved Resistance Coupler



Here is the result of months of experimentation in the Brach Laboratories. Unusual features such as standardization and interchangeability for all stages have been accomplished by the use of a 1-micro-farad condenser and specially designed resistors that are non microphonic and capable of withstanding high voltages. To insure permanent uniformity all connections are either soldered or held by screw pressure instead of the usual spring contact.

These features have been at once recognized by Radio Engineers of national repute who have replaced resistance couplers with *Brach Pur-A-Tone Audio Couplers* in order to obtain maximum results.

## BRACH-STAT AUTOMATIC Filament Control

### The Ultimate Standard for Fine Receivers

Brach-Stats completely eliminate the need for hand rheostats, on all amplified circuits—fewer controls—better operation.

The uniformity of control of the filament current obtained by the use of Brach-Stats has far exceeded the greatest expectations of noted Radio Engineers.

All set constructors should provide for their use.

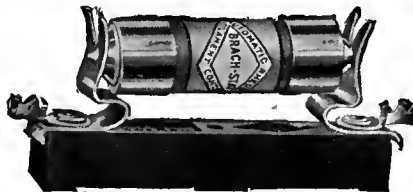

*Brach Pur-A-Tone Audio Couplers and Brach-Stats are notable contributions to the successful Roberts Circuit featured in this issue of Radio Broadcast.*

**L. S. BRACH MFG. CO., NEWARK, N. J.**

*Electrical Specialists for Over 20 Years*

## PRELIMINARY TEST TO INVESTIGATE RADIO INDUCTIVE INTERFERENCE

### FIRST TEST:

*To determine if the noise in the radio receiver is due to a fault in your receiver or is actually interference coming in on the air.*

Disconnect your antenna and ground wires and if there is no reduction in the intensity of the noise while the broadcast music is stopped by the disconnection, the probability is that the source of the noise is in your own receiving set, in the form of a loose connection, faulty batteries, or defective tube.

Also shake your ground wire near the ground connection to make sure that the noise you hear is not caused by a bad connection at this point.

### SECOND TEST:

*To determine whether the interference originates in your own house lighting circuit.*

From cases of interference investigated it has been found that a great number of these are of a purely local nature, originating in such sources as a lamp loose in its socket, or a loose plug of a heater, or from faulty household apparatus. While the interference is apparent, have somebody open your main house-lighting switch for a few seconds while you listen in on the radio receiver. If the interference stops when the switch is open, the source of the interference is probably in your own circuit. This test should be repeated several times, however, as there may have been a misleading coincidence with something occurring outside at the instant this switch was opened. Many sources of interference do not start again immediately the switch is closed, so that observations taken at the instant of opening the switch are more reliable than those taken at the instant of closing it.

### THIRD TEST:

*To determine the extent of the area affected by this interference.*

When you are assured that the interference comes in on the air and does not originate in your own set or in your own house lighting circuit, you should cooperate with others in your district who have radio receivers. Great care should be taken in making this test to avoid the danger of confusing the interference which originates from different sources, which may appear similar in the radio receiver. The most satisfactory way of making this test is for one observer to listen to the interference received on two radio receivers at different points at the same time by means of the telephone system. To carry out this test, an assistant at the distant radio receiver should place his head-phones (or preferably his loud speaker) near the transmitter of the telephone in order that the observer at the other radio receiver may listen at the same time to the interference heard on his own receiver at his right ear, while listening to the interference heard at the distant radio receiver by means of the telephone to his left ear. This test should be continued for a sufficient length of time to observe a number of variations in the nature of the interference.

In cases where it is not convenient to use the telephone system for this test, the two observers at distant radio receivers may keep an accurate log of the interference, but in this case they should first synchronize their watches and record any characteristic change in the interference heard, noting the time accurately to within a few seconds.

### FOURTH TEST:

*To determine if any suspected source actually causes radio interference.*

In carrying out this test either of the two

## RADIO BROADCAST

*For December*

will be a better magazine than this. Make sure of it by telling your newsdealer to hold one for you—or better still, subscribe through him or direct.

**RADIO BROADCAST**

Garden City

New York



### ★ NO MORE LOOSE CONNECTIONS X-L PUSH POST

A Binding Post that really does excel, looks, action, service and convenience. Push it down—insert wire—cannot jar loose from vibration. No screwing or danger of shearing off wires. Furnished attractively plated with soldering lug and necessary markings.

Price Each, 15 Cents

X-L RADIO LABORATORIES  
2424 Lincoln Ave. CHICAGO

## FORMICA ★ RADIO PANELS TUBES AND RODS

WRITE TO-DAY for your copy of our new catalog listing and pricing 3384 different sizes and kinds of Formica Radio Panels, 126 different sizes of Formica Tubes, and 21 different sizes of Formica Rods.

**DRILLING—ENGRAVING**

Lowest prices consistent with good work.

**STARRETT MFG. CO.**

521 S. Green St. - Chicago, Ill.





# CLAROTUNER

**A** KNOCK-OUT for the Knock-out!"—that's what a prominent engineer said when he saw the CLAROTUNER in action. And the moment you lay eyes on this latest creation, the moment you discover how miraculously sharp is its tuning, you will be just as enthusiastic. You will realize why Radio Broadcast experts recommend it, and use it in the Radio Broadcast Knockout, Roberts, Phonograph Model and similar hook-ups.

Low-loss coils, sturdy compactness, and absolute one hole mounting are only a few of the features. The biggest thing is the precision control—as smooth as velvet. The antenna coupler, by the way, is one hole mounting too, and eliminates all extra switch points and levers. Ask your dealer!

CLAROTUNER, model 2RK (two units as shown). . . . \$7.50

*(In case distribution has not reached your dealer, send your remittance direct to the address given below.)*



The famous  
CLAROSTAT,  
heart of the  
CLAROTUNER.  
\$2.25



**a knockout  
for the knockout!**

Write for free literature.

American Mechanical Laboratories, Inc., 285-287 North 6th St., Brooklyn, N. Y.



**The Season's Sensation**

**\$15<sup>00</sup>**

Design Patented

**THE KODEL MICROPHONE LOUD SPEAKER** is an exact replica of the transmitting microphone used in broadcasting.  
 The efficient Kodel reproducing unit, with an ingenious new snail-shell horn, mounted inside the microphone case, produces a remarkably clear, full-toned volume. Non-vibrating tone chamber eliminates distortion.  
 The \$15 model incorporates the new Kodel, Jr. unit; with the large Kodel unit, \$20.  
*Radio dealers everywhere have them*  
**THE KODEL RADIO CORP.**  
 505 E. Pearl St., Cincinnati, O.

**The KODEL MICROPHONE LOUD SPEAKER**

systems referred to in Test No. 3 is suitable. Great accuracy is required in these tests, for it has been found that many misleading reports have been received from observers who were not sufficiently accurate in their observations. For instance, interference has been reported to be associated with the switching on of the street lights in cases where the interference actually was produced by another circuit which was switched on every evening about dusk. If the observers in this case had noted the time very accurately, the source of the interference could have been located much more readily.

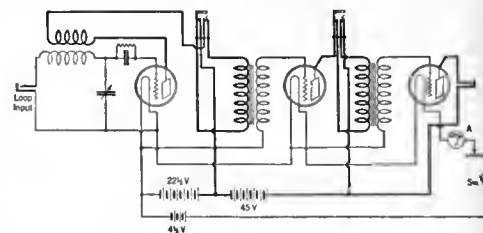

FIG. 1

This circuit, in conjunction with a loop may be satisfactorily employed to locate some sources of interference

## FIFTH TEST:

*To determine where the interference radiates from, by means of a portable radio receiver.*

In cases where a portable radio receiver is available the source of interference may be very often traced by this means. In cases where the radio interference is of such a weak nature that it only interferes with the reception of distant broadcast signals, a very sensitive loop receiver is required to pick this up. A portable super-heterodyne receiver complete with batteries thoroughly shielded is best for this purpose. A much less sensitive receiver may, however, be used in connection with the loop which will be suitable for determining the conductors from which the interference radiates. In cases where the interference is coming in along the conductors of the electric light or power system, a single circuit regenerative receiver having two stages of audio frequency amplification is sufficiently sensitive to give indication when the loop of the receiver is placed within a few yards of the conductor radiating the interference.

A detailed description of more elaborate apparatus used by Canadian Government Radio Inspectors and suitable for investigation in power houses will be published in another pamphlet now in course of preparation.

## GENERAL NOTES

**I**N MAKING all these tests it is important to approach the subject with an unprejudiced mind as to the source of the interference, and before concluding that the interference is caused by any given source, it is well to consider all possible conditions in which the interference may have originated from some other unknown cause. Investigating interference is a very fascinating detective game and one would sometimes suppose that the source of the interference had a sense of humor and was trying to evade detection in a manner similar to that of the most clever criminal.

The obvious and only satisfactory method of suppressing radio inductive interference that is caused by electrical apparatus which is defective, is to put this apparatus in good condition. The owners of such electrical apparatus are usually very pleased to have their attention drawn to the fact that their apparatus is in need of repair.

### Could You Use More Money?

No matter what your present income is, wouldn't you like some extra cash?

Well, here's your chance to get it!

DOUBLEDAY, PAGE & CO. wish to enlist earnest and reliable men and women throughout the country who will appreciate an opportunity to make money.

Our plan insures immediate cash returns, in amounts limited only by your own ability.

This is no ordinary subscription proposition. You can't afford to overlook it.

Write Agents' Service Division

DOUBLEDAY, PAGE & CO.

Garden City, N. Y.



## Vigilance

**Constant vigilance is the price of uniformity and constant vigilance is maintained over Magnatrons. That is why Magnatrons are uniform, and uniformly good.**

*The Magnatron DC-201A, DC-199, and DC-199 (large base) now list for only \$2.50 each.*

Connewey Electric Laboratories  
Magnatron Bldg. Hoboken, N. J.

**MAGNATRON  
R E X**  
the new  
tube for  
'B' battery  
eliminators

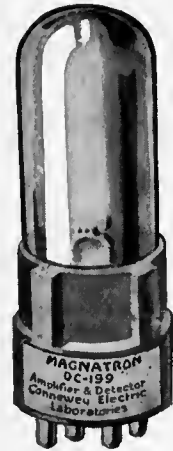

# MAGNATRONS

# The AMSCO ALLOCATING CONDENSER (STRAIGHT LINE FREQUENCY)



## Spreads the Stations Over the Dial

—The new AMSCO Allocating Condenser is the triumphant combination of electrical engineering and mechanical ingenuity. Electrically efficient in unscrambling the stations on your dials. Each dial degree from 1 to 100 will be found to represent 10 broadcasting kilocycles accurately over the entire scale—"a station for every degree". Mechanically ingenious in correcting the fault of other S. L. F. Condensers—it conserves space! Scientific low-loss construction. Rigidity with light weight.

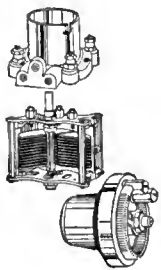

Made in three capacities—Single or Siamese. Ask your dealer, or write for details of the entire AMSCO Line of engineered radio parts.

AMSCO PRODUCTS, INC. Dept. E  
Broome and Lafayette Streets, N.Y.C.



**New!**—a handsome instrument at a low price. The AMSCO Vernier Dial gives fineness to your fingers. Steps-down 13 to 1, backwards or forwards, fast or slow without momentum or back-lash.

## WHAT OUR READERS WRITE US

*J. H. Dellinger Praises Our  
Frequency-Wavelength Policy*

AS WE stated in our August number, RADIO BROADCAST will no longer use the term wavelength except in parentheses after its equivalent in kilocycles. It is probable that everybody ultimately will fall in with this idea, and already condenser manufacturers are realizing this is so, and are designing new instruments giving a straight-line frequency reading. These latter have specially shaped plates designed so that any movement of the dial will give a reading in degrees directionally proportional to the frequency, all the way around the dial. We recently had a letter from Dr. J. H. Dellinger, the president of the Institute of Radio Engineers, in which he commends us upon our step.

Editor, RADIO BROADCAST,  
Doubleday, Page & Company  
Garden City, New York.

SIR:

Ever since the Second National Radio Conference, held in 1923, there has been an increasing use of the concept of frequency and its expression in kilocycles in place of the use of wavelengths in meters. The realization has rapidly spread that the use of wavelengths in radio is unnecessary and that its original introduction was a mistake. I have noted with pleasure the statement of policy on page 499 of the August RADIO BROADCAST, namely, that in future issues of the magazine frequencies will be used as standard, with wavelengths given thereafter in parentheses. Not only was this policy stated but succeeding issues of the magazine have proved that the editorial staff intend to abide by this announcement. With convenient conversion tables freely available and with excellent articles like that of Professor Morecroft's in your August issue explaining the superiority of frequencies in kilocycles, there is no longer any reason why this change of practice should confuse anyone. I congratulate you on assuming a position of leadership in this change to a modern and rational basis of radio expression.

Very truly yours,  
J. H. DELLINGER  
President, Institute of Radio Engineers.

## What a Foreign Reader Thinks of "Radio Broadcast"

THE following congratulatory letter was received recently from the Count de Warn, who was a High Commissioner of the International Amateur Congress of 1925 held in Paris.

Editor, RADIO BROADCAST,  
Doubleday, Page & Company,  
Garden City, New York.

SIR:

I have just come across a copy of RADIO BROADCAST. Allow me to congratulate you for your very excellent magazine which I did not know of before. Although I am a bit late, please put me down for a five years subscription for which I enclose my cheque. I intend to try a super-heterodyne of American make and hope that you will advise me on this question.

Yours faithfully,  
COUNT DE WARN,  
Alpes Maritimes, France.

## The Causes of Fading

THE late discussions of the fading of radio signals at the time of the total eclipse of the sun have revived interest in the popular

## WOULD YOU HELP YOURSELF TO OUR CASH BOX—if we said "GO AHEAD"?

ALL RIGHT, THEN—GO AHEAD! . . .  
THE CASH IS THERE. . . . And it's easy to get . . . .  
The Holiday Season is approaching with its heavy drain on your income. What are you doing about it?  
Will it be just as it was last year? Or do you really want some spare-time cash.  
If you are in earnest, let us tell you how you can get it.  
There's much to gain and nothing to lose.

Write: Agents' Service Division

DOUBLEDAY, PAGE & CO.

Garden City, N. Y.

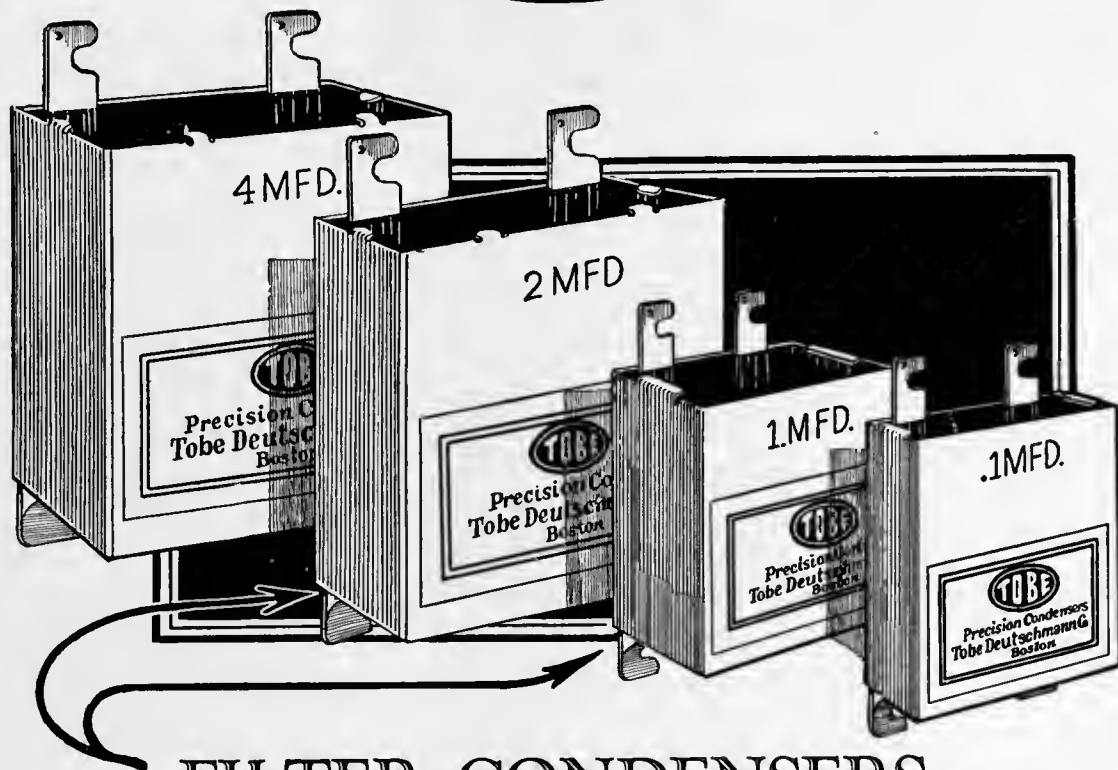

## FILTER CONDENSERS

*recommended for 'B' battery  
eliminator circuits*

**R**ADIO BROADCAST'S article in this issue on 'B' battery eliminators shows that the following TOBE condensers can be used in building the set: 5 type 708 and 7 type 709.

Any 'B' battery eliminator circuit depends very largely for its operating efficiency upon the filter condensers used. TOBE condensers alone possess all of the following favorable characteristics:

Will operate at voltages up to 700 D. C. without breakdown or overheating.

High megohm resistance—indicating perfect insulation. Capacities guaranteed to be within 5% of accuracy.

Extreme heat or cold has no effect on TOBE condensers. Compact and handsome in appearance.

Tobe condensers are better condensers—distinguishable by their silvered finished case. Ask your dealer for them by name "TOBE."

.1 M.F.D.	Type 705	Price \$ .70
1. M.F.D.	Type 708	Price 1.25
2. M.F.D.	Type 709	Price 1.75
4. M.F.D.	Type 711	Price 3.75

**Tobe Deutschmann Company**  
CORNHILL BOSTON, MASS.



*"Astoundingly Selective"*

*"Delightfully clear tone with Amazing Volume"*

*"Tremendously Powerful"*

*"Gets 200 to 600 meter Stations coast to coast"*

*"A great big beautiful set"*

*"Simple to tune - easy to log"*

**BUILT LIKE—LOOKS LIKE—PERFORMS LIKE A \$200 SET**

NOTICE! Enormous demand for the celebrated Miraco Ultra-5 (resulting from its many enthusiastic users so highly recommending it to their friends) has enabled us to add hosts of costly new features, refinements and improvements such as you might expect to find only on the newest sets selling at higher prices.

**MIRACO RADIO GETS 'EM COAST TO COAST**

*Reports from Ultra-5 users everywhere leave little for us to add. These are typical of the many in our files and which we receive daily.*

**PENNSYLVANIA HEARS CALIFORNIA VERY LOUD**

I received the Ultra-5 Set, set it up as directions called for, and received Dallas, TEXAS first station. Will list a few of the stations received in two hours: KDKA, WJLA, WGR, WJAW, WOS, WTAM, WCAE, WLW, WOO, WJY, WJS, KFI, KSI, WWJ, WHIN, WJIX. It is very easy for me to receive Los Angeles, California, loud enough to be heard in any room in the house. W. E. ... Uniontown, Penna.

**CALIFORNIA GETS NEW YORK ON LOUDSPEAKER**

I have got stations from coast to coast without any trouble at all on the Ultra-5. WTAM, Cleveland, Ohio, comes in on loudspeaker nearly as loud as the nearby stations do. I have brought in on loudspeaker with ample volume to hear all over the room stations WEAF, N. Y., KDKA, Pittsburg, Pa., WGY, N. Y., CHIC, Ottawa, Wis., Cincinnati, WOCG, St. Paul, Minn., WLS, Chicago, S. S. .... Dorris, California.

**NEW JERSEY HEARS CALIFORNIA ON LOUDSPEAKER**

MIRACO Ultra-5 working fine. Have received Western coast. Had two stations in California on same night. Have had many other stations. Receive all other stations with loudspeaker. Niverson Van. .... Freehold, N. J.

**MONTANA HEARS BOTH COASTS**

Ultra-5 Set is O. K. Have got New York to Los Angeles, Winnipeg to Dallas, Texas. Have had some 60 odd stations in two weeks. W. H. .... Polson, Montana.

**RADIO EXPERT SPEAKS FROM EXPERIENCE**

As I sell almost all kinds of sets, I have operated all of them and will state that the Miraco Ultra-5 is as good if not better than any other set in the market today. Felix J. .... Pawtucket, Rhode Island.

**PREFERS IT TO \$150 SETS**

I received my Miraco Ultra-5 Radio Set and it surely is a peach. I have tried and heard radios up to the value of \$150.00, but I like yours the best. William L. .... Syracuse.

**ILLINOIS HEARS ALASKA**

The night I received the Ultra-5 tuned in New York City. The second day I tuned in KFI, Los Angeles, Calif., and KFI, Juneau, Alaska, and heard anything in the United States. I will put it against any set I have ever heard. H. H. .... Ashkum, Illinois.

**GOT CALIFORNIA BETTER THAN \$269 SET**

Received the Miraco Ultra-5 the other day and it is a big surprise. Compared it with my friends' \$269.00 ..... and could bring them in just as loud and clear on my Ultra-5. Really I brought in Los Angeles, California, on speaker louder than he did. Am more than pleased. Kyle .... New Albany, Miss.

now only \$59<sup>50</sup> retail

SEND FOR SPECIAL OFFER!

The Powerful New **MIRACO Ultra-5**

[FIVE TUBE OUTFIT IN BEAUTIFUL MAHOGANY CASE]

Let the testimony of its many users everywhere—as voluntarily reported to us in writing—convince you that a Miraco Ultra 5 actually is unsurpassed for selectivity, long distance range, clear tone, loud speaker volume and beauty—combined with economy and simplicity of operation—at several times the price. Send coupon for plenty of this proof and reports of users which leave no doubt that the Miraco Ultra 5 gets programs coast to coast. Completely built, carefully tested and factory guaranteed by one of America's oldest and most successful makers of quality sets, the Miraco Ultra-5 illustrated above (latest improved model for 1926) in the opinion of radio experts is an astonishing bargain. Selectivity, long

distance reception, clarity and volume have been amazingly increased—"B" battery consumption is minimized—oscillations are easily controlled on all wave-lengths, through use of latest radio inventions. Among these are: "Duo-formers" (ultra low-loss inductance coils); the "Counter-Balancer" (patented); flexible wiring which prevents broken or noisy connections; an adjustment for different length aerials; use of only two rheostats; a cut-out switch; concealed wiring under genuine Formica sub-panel; beautifully gold-etched genuine Formica front panel; large Bakelite knobs with "arrow point" indicators (for fine tuning)—and other features of costliest sets. Literature describes them fully. Send for it—and Special Offer!

Other Miraco Long Distance Sets \$13<sup>50</sup> up retail

Wonderfully improved new models in one-tube and three-tube Miraco Long Distance Sets also ready at lower prices! Powerful new Miraco R-3 at only \$27.35 (retail) operates loud speaker on distant stations. New one-tube Model R is also

a record-breaker for distance at \$23.75. All Miraco sets work on storage or dry batteries, are easily connected and operated. Unmatched values! Let testimony of users convince you. Write for literature and Special Offer—use coupon.

*All the Proof you want is waiting for You!*

Reports from their host of users in every state prove Miraco sets—at their rock-bottom factory prices—outperform sets costing up to three times as much. Send for latest literature, SPECIAL OFFER and plenty of additional testimony from users leaving no doubt that "Miraco Radio Gets 'em Coast to Coast". SEND COUPON FOR SPECIAL OFFER

**AGENTS, DEALERS**  
Write for the new Miraco proposition!

**MIDWEST RADIO CORPORATION**  
Pioneer Builders of Sets, 406-F, E, Eighth St. Cincinnati, O.  
Send free literature, SPECIAL OFFER and all particulars regarding Miraco Sets. ( ) Agent ( ) User ( ) Dealer.

NAME .....

ADDRESS .....

# How To Use Radio Tubes

is the title of an article by Keith Henney, Director of the Radio Broadcast Laboratories, to be printed in the December issue. Special attention is given to the new tubes by the Radio Corporation of America. Much help will be given on how to use the best tube for the best purpose.

Reserve a copy of December Radio Broadcast at your news dealer or radio supply store.

mind about this peculiar and little-known peculiarity of radio transmission. It is probable that scientific and popular interest in the fading of signals is more acute now than it ever has been before. The suggestions below were written by an electrical engineer whose theories are certainly interesting. Elsewhere in this issue the probable causes of fading are ably discussed but so interesting is the letter below that we make no apology for covering the subject in two separate departments.

Editor, RADIO BROADCAST,  
Doubleday, Page & Company  
Garden City, New York.

SIR:

It is generally recognized that air molecules are ionized by the sun's rays and that the resulting charged air dissipates the energy of radio waves, since it is a partial conductor of electricity. Likewise an ionized layer of air, being a conductor, will act in the same manner as a metal reflector, though in less degree, to reflect the radio waves. As night approaches, the air becomes less and less conductive with consequent increase of signal strength, but it is highly probable that the air is always slightly ionized, even in the absence of the sun's rays. This may be a result of light from the stars and moon, or the air may retain some of its charge for long periods after the ionizing rays of the sun have been removed. Even if the lower layers of air between two stations are completely neutral, electrically, there is the possibility that the upper layers are acted upon by sunlight, especially if the stations are in an east-west line. It has been stated by observers that the worst fading occurs in such a direction.

Now as to the real causes of fading, there are possibly three, which may be: (1) at the sending station, (2) at the receiving station, and (3) between the two stations. It is possible that there may be a cyclic variation in the electrical state or condition of either the sending or receiving apparatus (tubes), but this is rather doubtful. Of course an antenna system swayed by the wind will become detuned, and there is an additional probable cause, in that layers of air of varying density may pass under the antenna and thus alter its capacity. If either of these two factors just mentioned were the contributing cause, it would be possible to tune the station in again by adjusting the controls. However, in all too many cases no amount of tuning will bring in the station. We must wait a few minutes until the signal increases in strength of its own accord. Generally this is a gradual increase.

The facts seem to indicate that fading is due to variable conditions existing between the sending and the receiving station. We know that there are always layers of air of different densities, temperatures, and humidities, and if we grant that these layers are always slightly ionized, which is likely, we have at once a plausible explanation for fading. For suppose that a station is receiving with good audibility at any one moment, and suppose, then, that an extended layer of ionized air drifts between the sending and receiving station. The signal waves will then be both reflected and absorbed by the conducting "sheet" of air, and therefore the signal strength at the receiving station will be materially reduced until the ionized body of air has drifted past the path between the two stations. There are, of course, many moving layers of air between two stations widely separated, and consequently it would be expected that fading would be worse for such stations.

The varying ionization of the layers of air would result from the varying factors such as temperature, density and humidity, when the air is exposed to the same ionizing source such as sunlight. A further cause of ionization is the friction of the various air streams.

There is still another possible cause of fading in that the numerous ether waves may interfere to cause partial neutralization, but the air layer explanation seems more plausible.

Yours very truly,  
A. G. THOMAS,  
Lynchburg, Virginia.

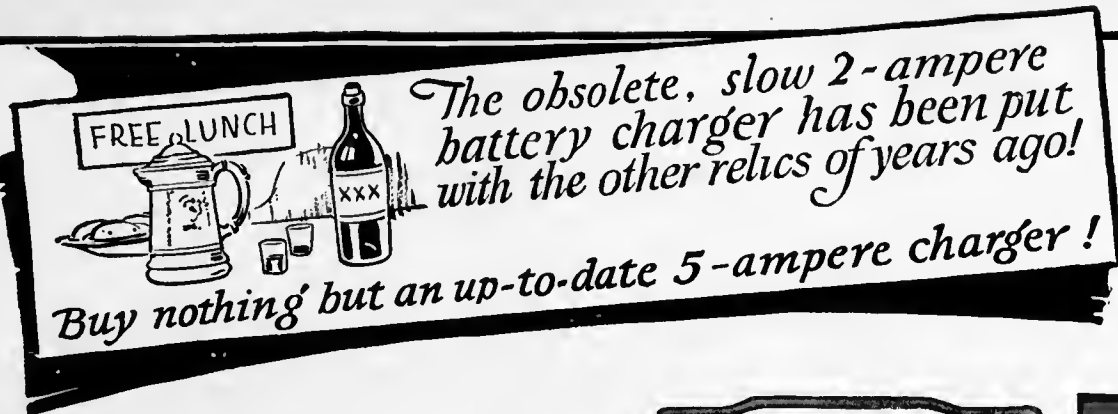

The New Improved  
 5 AMP. A & B  
 GOLD SEAL  
**HOMCHARGER**  
 \$19<sup>50</sup>



Over 500,000 already in use

# Charges in One-Third the Time!

## Better Because:—

New micrometer adjustment, hinged lid, and carrying handle. No bulbs to buy or break.

Can be used anywhere—contains no acids or other harmful liquids to spill.

Approved by underwriters—trouble-proof, shock-proof and fireproof.

Beautiful cabinet in maroon and gold.

**Free** Write for new edition of our instructive booklet on radio operation "The Secret of Distance and Volume in Radio."

It takes only one-third as long to fully charge your battery with the New Improved 5-ampere **GOLD SEAL HOMCHARGER**.

No more of the long, bothersome waits that were necessary when the slow inefficient 2-ampere charger was the best that radio offered. The New Improved **GOLD SEAL HOMCHARGER** charges 150% faster—fully charges the average battery overnight—and it charges both **A and B** batteries without additional equipment.

Before you buy any charger be sure it charges at 5-amperes. To be absolutely sure insist on the **GOLD SEAL HOMCHARGER**.

**The Kodel Radio Corporation**  
 505 East Pearl Street Cincinnati, Ohio



# RADIO BROADCAST

ARTHUR H. LYNCH, Editor  
WILLIS K. WING, Associate Editor  
JOHN B. BRENNAN, Technical Editor

DECEMBER, 1925  
Vol. VIII, No. 2

## CONTENTS

Cover Design	- From a Painting by Fred J. Edgars	
Radio Enters the Club	Frontispiece	
How Radio Grew Up	Robert H. Marriott	159
Tubes: Their Uses and Abuses	Keith Henney	163
The March of Radio	J. H. Morecroft	167
A Five-Tube Receiver of Dual Efficiency	Glenn H. Browning	172
The Listeners' Point of View	Kingsley Welles	177
Short Waves—A New Paradise for the DX Fan	Edgar H. Felix	182
Plans for the Third of the International Radio Broadcast Tests	Arthur H. Lynch	185
An Improved Plate Current Supply Unit	Roland F. Beers	186
As the Broadcaster Sees It	Carl Dreher	191
The "Aristocrat" Receiver: Resistance-Coupled Amplification		196
How to Use Meters in Your Receiver	James Millen	198
New Fields For the Home Constructor	Keith Henney	201
"Now, I Have Found"		206
<small>Tracing Radio Noises A Ratchet Coil Winder A Coupling Device for the Roberts Circuit A File for Ideas Super-Herodyne Noises Checkit up on B-Battery Leakage A Variometer for the Roberts Set</small>		
How to Eliminate Local Interference		212
A List of Australian Broadcasting Stations		224
The Grid—Questions and Answers		226
<small>Coil Placement in an R. F. Amplifier Precautions in Antenna Erection Measuring the Resistance of Coil Units Matching Tubes and R. F. Coils</small>		
A Key to Recent Radio Articles	E. G. Shalkhauser	232
Is Your Set a Blooper?		238
What Our Readers Write Us		244

## BEHIND THE EDITORIAL SCENES

THE new and enlarged RADIO BROADCAST has met with almost universal favor and its reception was even more hearty than the publishers had dared hope. In New York City alone, the supply of the November number was exhausted four days after it was placed on sale. Copies of the number are so rare that we haven't more than three copies in the editorial offices for our own use. Letters from readers all over the country have been most generous in praising the appearance and contents of the November number.

ROBERT H. MARRIOTT, whose article, "How Radio Grew Up" leads this issue, is one of the old men of wireless in the United States. He was the first president of the Institute of Radio Engineers, was one of the first radio inspectors to be appointed after the radio law of 1912 was passed. For a long time he was expert radio aide at the Bremerton Navy Yard, Washington, and is now a consulting radio engineer in New York. . . . Edgar Felix, who writes about short waves in this number, was for several years publicity representative of station WEAJ in New York. Glenn H. Browning, who with his inseparable technical partner, Mr. F. H. Drake, has become nationally known for the Browning-Drake receiver, describes a great improvement over the early model in this number. Both Mr. Browning and Mr. Drake are familiar figures around the famous Cruft laboratory at Harvard University, where much of their work has been done. The valuable current periodical surveys, made by E. G. Shalkhauser, the first of which appeared in our November issue, are continued in this number. Many readers have written us saying that these condensed surveys of the important articles appearing in this magazine and in our contemporaries are of great value to them.

THE January RADIO BROADCAST will contain an article by Arthur H. Lynch telling how to build "RADIO BROADCAST'S Universal Receiver." The set he describes is an unusual and very efficient combination of standard parts and it is doubtful if there is any receiver its superior in point of sensitivity and quality. It is not a "freak" outfit in any sense. Kendall Clough of Chicago will have an article about the principles of audio amplification which is of particular interest. The author weighs and casts aside some of the commonly accepted theories of amplification. We believe the article will attract a great deal of attention. Mr. John Wallace of Evanston, Illinois, will from now on write the "Listeners' Point of View." With his central location, Mr. Wallace is able to hear broadcast offerings in almost every part of the United States and Canada. Our new broadcast critic is an unusually versatile person, for he is a writer of great charm and not a little wit, as well as an artist of considerable ability. In his college days, his drawings and humorous "pieces" appeared in the *Cornell Widow*.

THE advertising pages of the magazines of the "Quality Group," that is, the *Atlantic Monthly*, *Harpers, Review of Reviews*, *Scribners*, and the *World's Work* now contain only the announcements of those radio manufacturers whose products have been tested and approved by the Laboratory of RADIO BROADCAST. Readers of those magazines who are not well versed in matters radio have the privilege of calling on the technical staff of this magazine for help and advice.

<p><i>Doubleday, Page &amp; Co.</i> MAGAZINES</p> <p>COUNTRY LIFE WORLD'S WORK GARDEN &amp; HOME BUILDER RADIO BROADCAST SHORT STORIES EDUCATIONAL REVIEW LE PETIT JOURNAL EL ECO THE FRONTIER</p>	<p><i>Doubleday, Page &amp; Co.</i> BOOK SHOPS</p> <p>NEW YORK: { LORD &amp; TAYLOR BOOK SHOP PENNSYLVANIA TERMINAL (2 Shops) 38 WALL ST. GRAND CENTRAL TERMINAL</p> <p>ST. LOUIS: { 223 NORTH 8TH STREET 4914 MARYLAND AVENUE</p> <p>KANSAS CITY: { 920 GRAND AVENUE 306 WEST 47TH STREET</p> <p>TOLEDO: LASALLE &amp; KOCH CLEVELAND: HIGBEE CO. SPRINGFIELD, MASS.: MEEKINS, PACKARD &amp; WHEAT</p>	<p><i>Doubleday, Page &amp; Co.</i> OFFICES</p> <p>GARDEN CITY, N. Y. NEW YORK: 120 WEST 32ND STREET BOSTON: PARK SQUARE BUILDING CHICAGO: PEOPLES GAS BUILDING SANTA BARBARA, CAL. LONDON: WM. HEINEMANN LTD. TORONTO: OXFORD UNIVERSITY PRESS</p>	<p><i>Doubleday, Page &amp; Co.</i> OFFICERS</p> <p>F. N. DOUBLEDAY, <i>President</i> A. W. PAGE, <i>Vice-President</i> NELSON DOUBLEDAY, <i>Vice-President</i> RUSSELL DOUBLEDAY, <i>Secretary</i> S. A. EVERITT, <i>Treasurer</i> JOHN J. HESSIAN, <i>Asst. Treasurer</i></p>
--	---	---	---

DOUBLEDAY, PAGE & COMPANY, Garden City, New York

Copyright, 1925, in the United States, Newfoundland, Great Britain, Canada, and other countries by Doubleday, Page & Company. All rights reserved.  
TERMS: \$4.00 a year; single copies 35 cents.



# Real Progress in Radio



Emphatically Yes!

Radio IS marching forward, this season as before. But it is marching in a new direction.

*Quality of Reception.*

That is the big, new theme. And the new Jewett Receiver is its inspiration.

At last Radio commands a Receiver that is truly a Musical Instrument, by a manufacturer of experience in the musical instrument field.

Mere words cannot describe this new Jewett Quality of Reception. You must *hear* and understand.

So just visit an authorized Jewett Dealer and let him prove to you that here is a new kind of Radio—so different from the old as to create new standards and ideals.

*For the first time, B-Battery current and resulting distortion have been completely barred from the speaker circuit.*

You should know the story of this epoch-marking Receiver and its birth in the brains of our straight-thinking young engineers who refused to admit that it couldn't be done. Ask us for it.

*"There Is No Substitute For The Best"*

**JEWETT RADIO & PHONOGRAPH CO.**

5672 TELEGRAPH ROAD

PONTIAC, MICHIGAN

Factories: Allegan, Michigan—Pontiac, Michigan

In Canada: Jewett Radio-Phonographs, Ltd., Walkerville, Ontario

Export Sales Offices: 116 Broad Street, New York City



**The Jewett Receiver**

—Three simple controls provide distortionless reception and eliminate all receiver noises—The most richly beautiful Receiver you have ever seen.

**The Jewett Superspeaker**

—All that the name implies. Recommended by experts everywhere.

**The Jewett Superspeaker Console**

—A handsome cabinet with Superspeaker performance.

**The Jewett Cone**

—Faithful in tone and pitch regardless of heat, cold, or dampness. Semi-adjustable.

**The Jewett Vemco Unit**

—Makes a loud speaker out of your phonograph.

**The Jewett Parkay Cabinet**

—Puts the amateur on a par with the most exclusive cabinet worker.

**The Jewett Micro-Dial**

—Makes tuning 50 times as accurate. Fits any standard receiver.

**The Jewett Superspeaker Highboy**

—Houses any standard Radio set and all batteries. Superspeaker built in.

**"Quality Broadcasting to Match Quality Products —Station WJR"**

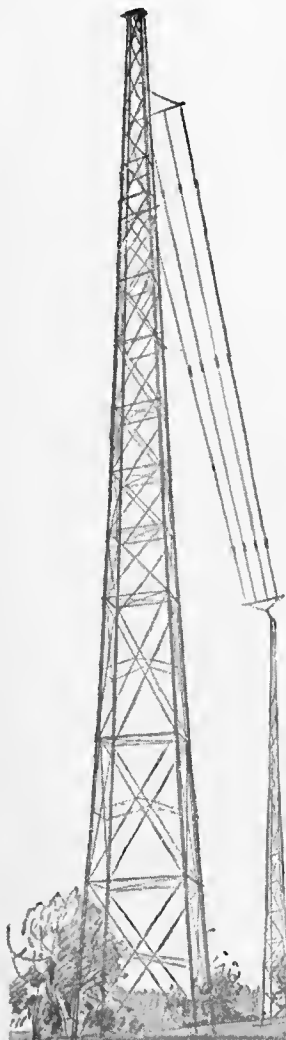

Special Wednesday WJR feature—The Burroughs Hour, 9 to 10 p. m.



©1925 Jewett Radio & Phonograph Co.

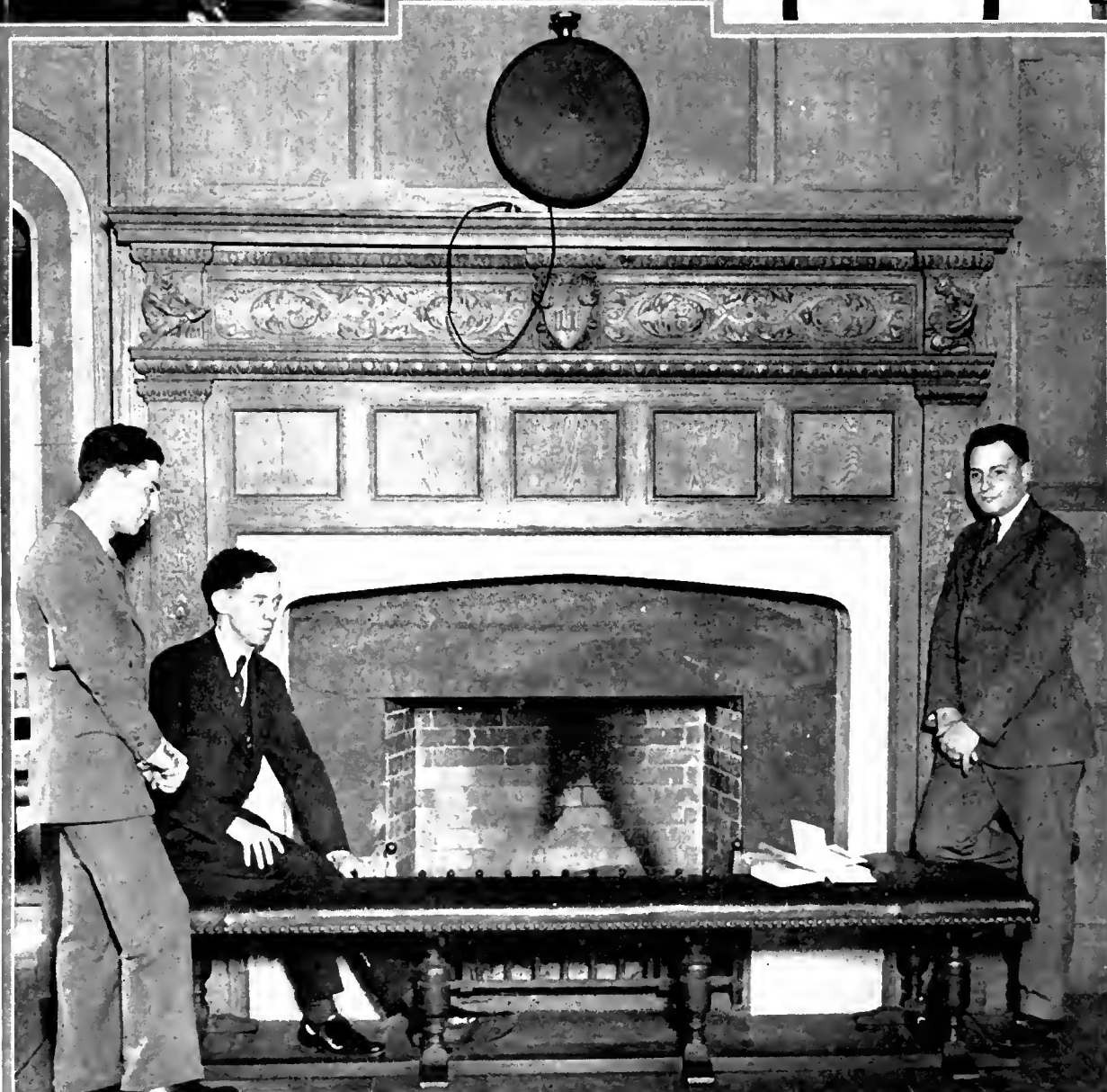
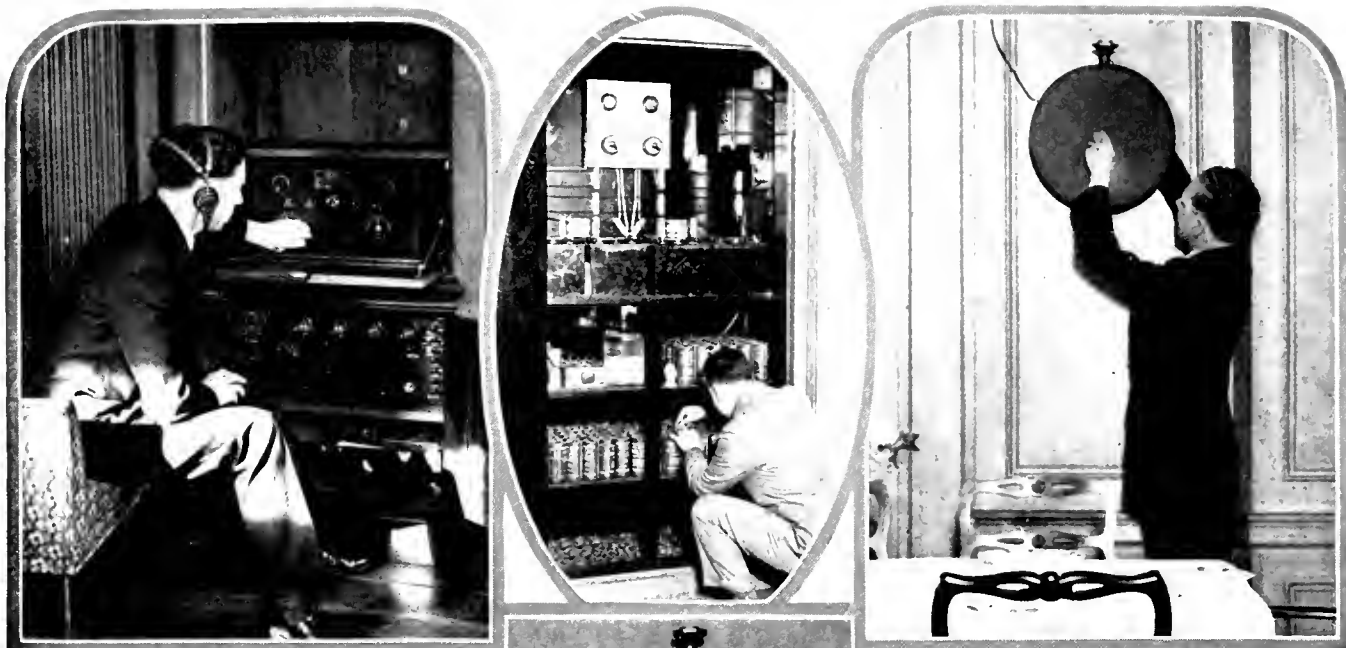

#### RADIO ENTERS THE CLUB

The installation at the Cornell Club in New York City. The Western Electric super-heterodyne with peanut tubes is shown in the top view at the left. A four-tube amplifier below intensifies the energy which is supplied to the loud speakers on the panelled walls of the various rooms. Employees of the Club are shown listening to the first test of the equipment. A public address system is also installed. Microphones pick up the speeches which are carried to all parts of the club through the loud speakers

# RADIO BROADCAST

VOLUME VIII



NUMBER 2

DECEMBER, 1925

## How Radio Grew Up

Many Little Known Facts About Radio Development are Related—Here Is the First of a Series of Articles on This Subject Written by a Pioneer in Wireless

By ROBERT H. MARRIOTT

*First President Institute of Radio Engineers*

**R**EPEATEDLY during the last one hundred years, radio has been referred to as new, which has had the result of making people come to the conclusion that it must be new. This is, of course, very confusing, and is due no doubt to the fact that certain inventions and inventors have been overrated while others have been forgotten. Human love of fairy tales makes it easy for a man or a corporation with money to refer to a certain individual as the great one who has done all of the wonderful things that have been done. Money getters, too, take advantage of that love of fairy stories to fill their pockets.

Haywire, halos, and haymakers have characterized many of the early careers in radio. Inventors and would-be inventors built haywire apparatus. Promoters built press agent halos around the alleged inventors and their haywire products. Some of the hay went to develop radio and a lot of it went to whoever received the stock jobber's money. Sometimes promoters became so extravagant in the claims about an invention that the inventor himself would be found to disclaim some of the things that he was purported to have done, and to give the credit to others. Such a procedure was, of course, just what the promoters wanted, and they immediately got their press agents and after-dinner speakers on the job, in order that they might tell how modest and generous the inventor was, and thereby stud his halo with the pearls of modesty and generosity.

Homage is due to many rather than to a few. Many radio develop-

ers have received little compensation for their work in the past and they are not in a position to collect now. The public owes a debt to many people which it cannot

pay. Some of those people need the money, others do not; some are dead while those still alive do not expect to realize anything on their past labors.

The changes in radio development may often be traced to unexpected causes. For example, the United States Prohibition Act seems to have played a somewhat important rôle in the recent stimulation of radio broadcasting. Volstead's unintentional creation of laborious home brewing and the attendant substitution of inconvenient bootleggers for bar tenders, has apparently been an important step in the development of radio, because it suddenly has shut off from the public a very convenient means of spending their money. Now these baffled people are looking for other outlets. Broadcast receiving has supplied that demand, and its problems present a new field in which alcohol-free brains may engage.

Not only is radio history valuable as a thing of interest, as educational, and as a precedent for use in planning the future, but it is valuable in other ways. I was recently examined and cross-examined for three days about historical radio devices, for evidence in a radio suit. I believe the suit was for several millions of dollars. At any rate the amount was so interesting that two lawyers and an expert traveled across the United States and back to get my testimony.

The lawyers' questions and my answers in that testimony took up more words than I am using in this whole series of articles. The testimony was relative to only a few historical devices which had their origin from 1899 on, while I am striv-



A PORTABLE SET, 1901 MODEL

Mr. Marriott operating a portable transmitting set. Note the ground plate on the floor. With an outfit about the same size as this, using vacuum tubes as the radio generating device, signals are being sent by amateurs using code, for tremendous distances. The Laboratory of RADIO BROADCAST recently communicated with the U. S. S. *Seattle* as she was leaving Tahiti in the Pacific ocean. A five-watt tube was used as a transmitter for this remarkable communication

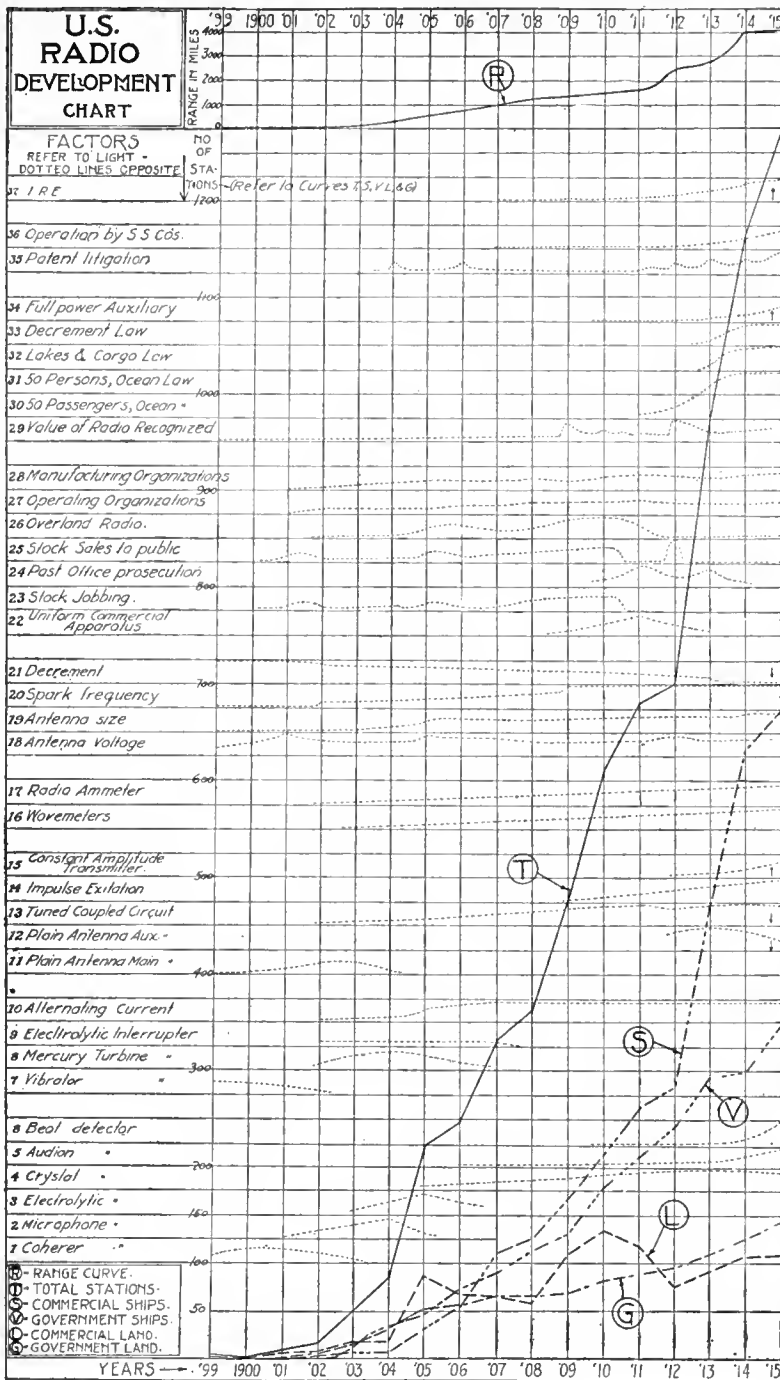

HOW WIRELESS DEVELOPED

One of a number of charts presented by Mr. Marriott in a paper published in the *Proceedings of the Institute of Radio Engineers* for June, 1917, showing graphically the rise and decline of the various radio factors. For example, the electrolytic detector, No. 3 in the charts, came into use about 1902, was the leading detector about 1905 and then gave way to crystal detectors, No. 4

ing in these articles to outline the more interesting points in the development of radio since about 1790.

Starting on our outline of radio history then, we find that Galvani got a "radio kick" out of frogs' legs even before 1790; De Salva wrote a recipe for a "wireless" in 1795; Morse built a "wireless" which worked across narrow bodies of water in 1842; Maxwell wrote a theory for radio in 1867; Loomis patented a "wireless" in 1872; Hughes made and used a radio in about 1879, but he only let a few friends in on it; Professor Dolbear patented one in 1886; Hertz made a tuned radio system according to Maxwell's recipe in 1886, and

that development led others in our radio of today.

MARCONI EXPLOITS RADIO

RADIO had been thus brewing since the 18th century. By 1895 it was ready for exploitation, by which I mean that it was ready for sales engineers, exploiters, promoters, advertisers, and others. Marconi demonstrated the more or less academic radio instru-



A VERTICAL ANTENNA

About the year 1900, vertical antennas were quite popular for land stations, but as wireless became more general and the installations more elaborate, the flat top horizontal type was almost universal. It is interesting to note that now, for short wave transmissions, amateurs and others are returning to the vertical antenna

ments to some politicians, army men, and money getters at this time. He played the part of a demonstrator and sales engineer. A money getting company was then formed



AT ANNAPOLIS

How the wireless towers looked when the picture was taken on October 25, 1902. On this day, some history was made, for, using this equipment, the Navy made its first record of about 50 miles by wireless from this equipment to a ship. Fifty miles, with the equipment known then was an extraordinary distance

which, in attempting to obtain a monopoly, set out to advertise to everybody that Marconi was the inventor and that they owned that patent on wireless which entitled them to a monopoly in America and other places. That was not, of course, true, but he did advertise wireless and to him is due the credit for having started the development of radio in many different parts of the world.

By 1900 radio had edged itself into the market as a mild public service. It continued as a tonic and stimulant for business, for military purposes, and for life saving. To obtain plenty of radio equipment for recent war purposes greater quantities of money and effort were suddenly put forth. In 1921 a radio by-product called broadcasting began to take on. Now it is a principal product, a product that sold for about \$350,000,000.00 last year. That is a very brief outline of some of the more important events in the history of radio.

Luigi Galvani was an Italian anatomist and he got the kicks from frogs' legs when he put them near an electric spark. Nowadays we would call his spark maker a radio transmitter while the detached frogs' legs acted as the radio detector. Therefore he must be credited with having made a genuine radio experiment one hundred and thirty-five years ago. The distance between the spark gap and legs must have been only a few inches or, at most, a few feet, and at that time the whys and wherefores probably were not realized.

On December 16, 1795, De Salva, a Spanish physicist, read a paper before the Academy of Sciences at Barcelona in which he said: "One could, for example, arrange at Mallorca an area of earth charged with electricity, and at Alicante a similar space charged with opposite electricity, with a wire going to, and dipping into, the sea. On lead-

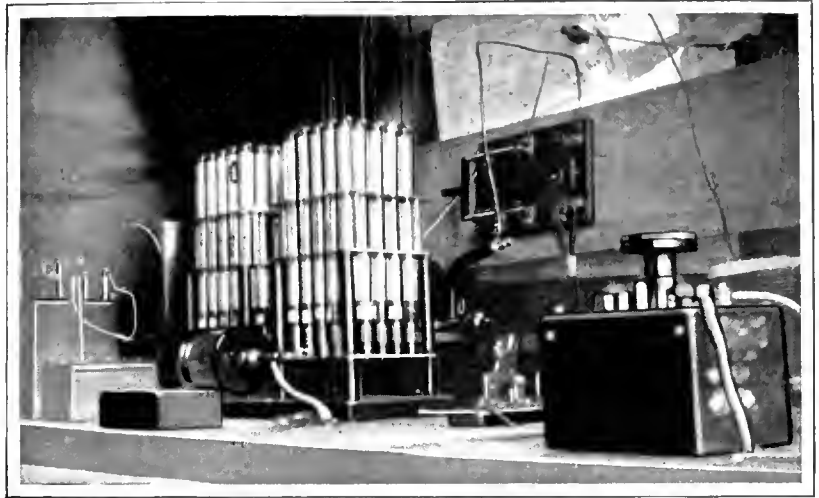

INTERIOR OF THE OLD ANNAPOLIS STATION

ing another wire from the sea shore to the electrified spot at Mallorca, the communication between the two charged surfaces would be complete, for the electric fluid would traverse the sea, which is an excellent conductor, and indicate by the spark the desired signal."

If Salva's scheme had worked as he said, it would

have been wireless, but not radio. He specified for the flow of a direct current from one station to the other, rather than waves composed of combined magnetic fields and condenser fields such as are radiated from one radio station to another. However he had the idea of establishing wireless communication. Therefore the idea of wireless communication by electrical means must be at least one hundred and thirty years old.

In 1831, Faraday demonstrated electro-

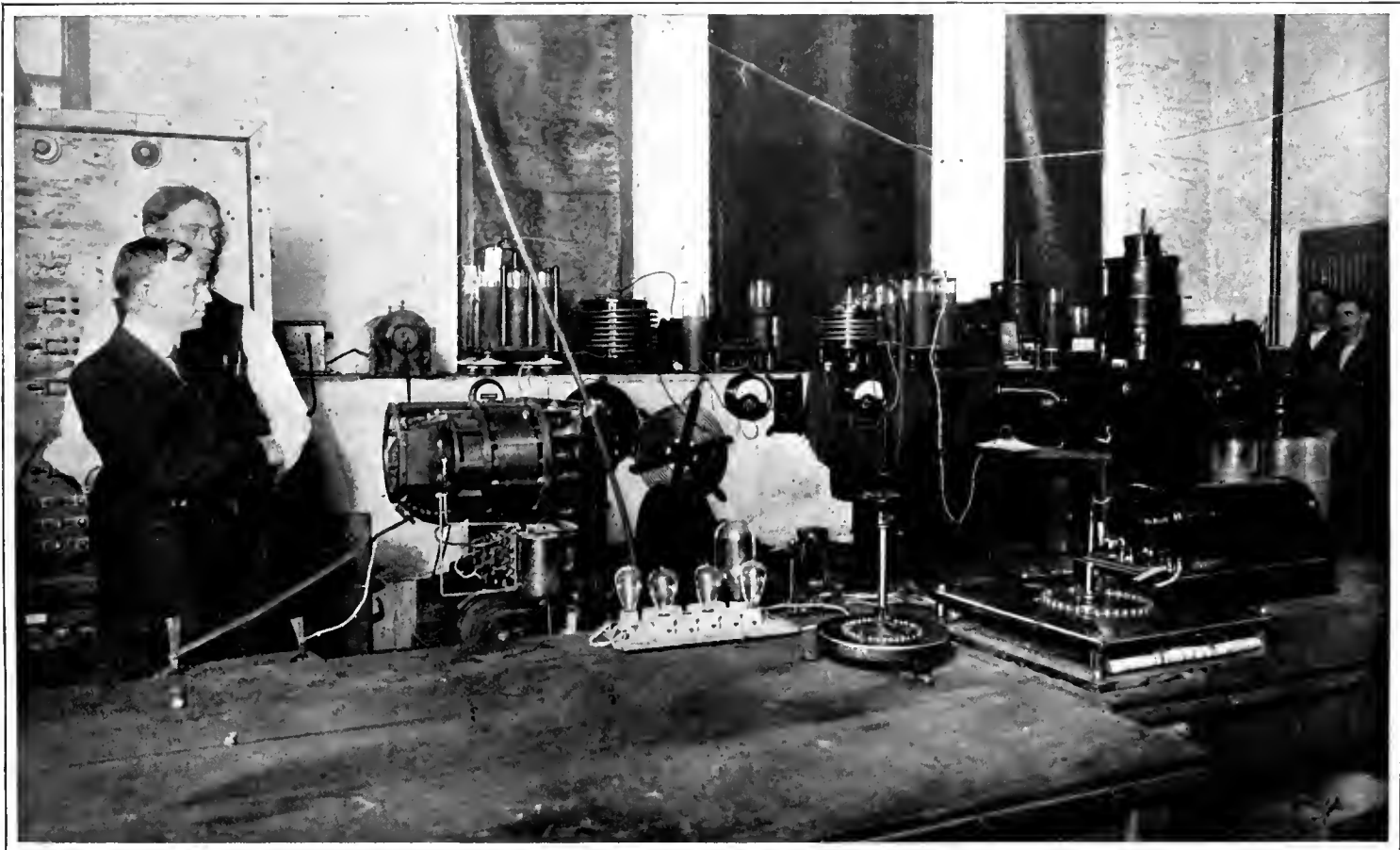

A GALLERY OF TRANSMITTING APPARATUS

In use between 1899 and 1915 set up in the Brooklyn Navy Yard. Mr. Marriott, at the left in the photograph, was the expert witness in a case tried before a United States judge in 1915. In the foreground, to the right, is a ten-inch induction coil, with separate vibrator. This was connected directly to the antenna and was popular until about 1906. Various kinds of glass jar transmitting condensers can be seen. The inductances, of large wire, are "oscillation transformers" and coupled the oscillating circuit, consisting of spark gap and condenser, inductively to the secondary circuit which had taps leading to antenna and ground. This is a most unusual historical photograph

magnetic induction. He showed that making current start and stop in one circuit would cause currents to flow in a circuit parallel to it, although there be no connecting wires between the two circuits. That was a kind of wireless, but it is not classed as the kind of wireless we call radio.

Professor Samuel F. B. Morse, of the United States, telegraphed across narrow bodies of water in 1842, by installing a ground return transmitter circuit along one bank and a ground return receiver circuit along the other, without any wires between the sender and receiver. His, again, was not radio communication but it was wireless communication. He not only had the idea of communicating without using wires between the transmitter and receiver, but he did actually telegraph with success that way. The currents between the points at which he connected his transmitter are supposed to have wandered across the stream and through the wire that connected the two points of ground or water contact of his receiver. That was a kind of wireless that worked, and it worked more than eighty years ago.

The electromagnetic theory, which is our present accepted theory of radio wave propagation, is said to have originated with William Clerk Maxwell, a noted Scotch physicist in about 1867, and it was published shortly after that time.

#### LOOMIS UTILIZES STATIC FOR SENDING

JULY 30th, 1872, patent number 129,971, was issued to Mahlon Loomis, dentist, of Washington, District of Columbia. The following is quoted from the patent.

What I claim as my invention or discovery, and desire to secure by Letters Patent, is—The utilization of natural electricity from elevated points by connecting the opposite polarity of the celestial and terrestrial bodies of electricity at different points by suitable conductors, and, for telegraphic purposes, relying upon the disturbance produced in the two electro-opposite bodies (of the earth and atmosphere) by an interruption of the continuity of one of the conductors from the electrical body being indicated upon its opposite or corresponding terminus, and thus producing a circuit or communication between the two without an artificial battery or further use of wires or cable to connect the cooperating stations.

Stating the Loomis claim briefly and in present day language; if you put up an antenna where it will get atmospheric charges, and interrupt the flow of current from the antenna to ground, you can send messages. If the atmospheric voltage is high enough so that the sparks from antenna to ground will jump a gap of one inch, it would be possible to send messages more than a hundred miles to a present day receiver. However, the atmospheric voltage is not reliable for telegraphing, because conditions vary widely in different locations and at different times. Unless you use a sensitive galvanometer you might be unable to detect any voltage on your antenna, the day you read this. On the other hand, it is not a safe thing to try, carelessly, because you might get too much voltage, especially just before a rain storm.

That arrangement as described by Loomis, has worked for me many times in years past and in fact I am experimenting with such a device at present. I am using the system to find out things about the unidentified noises that interfere with radio receiving, and about fading and static. The one I am working with now is interrupted by a little copper water wheel. When the voltage is low the current only discharges from the antenna through the longest paddle of the wheel. When the voltage is high it jumps to all four. Some of us can hear it click at our receiving stations and get an idea of what is happening in the atmosphere.

An observer might record the area and movement of high voltage atmosphere by setting up numerous Loomis antennas, with clock operated spark gaps having differently timed interruptions, in a

large circle around him and his receiving apparatus. Weather scientists may find this suggestion useful.

From observations made with this kind of an arrangement, it seems that some of the interference one hears on a broadcast receiver is probably due to the atmosphere charging insulated conductors to such a high voltage that the charge jumps over to earth in one spark which produces a click, or many sparks, that produce grinding, buzzing, or sizzling noises. The conductor in question might be a guy wire, fence wire, power wire, or something else. If electric power follows those pilot sparks to earth, you may hear an alternating current or commutator hum. Falling rain may contribute both voltage and moisture, causing a power circuit to leak over insulators.

I am not an inveterate story reader, but so far as I know, fiction writers have overlooked the possibilities of the Loomis antenna. All their hero or heroine needs for wireless salvation are the right weather conditions, an elevated conductor and the radio code. The villain might even grab the conductor and get a static knock-out. Loomis was away ahead of his time. His patent was not only for communicating without wires, but for taking the electricity to do it with from the atmosphere. He apparently did not reason according to the radio theory, but the idea he patented certainly works that way. He wanted to make static send messages. He probably imagined wonderful possibilities "via static," but I daresay he didn't go so far as

to imagine then that the new baby across the street was destined to make money from automobiles; move (he might even fly) to Southern California to a place called Los Angeles and there buy a winter home for a fabulous sum, retire and spend his time playing Mah Jongg or working cross word puzzles, and maybe even drinking home brew while listening to Washington jazz delivered without "wires," in 1925.

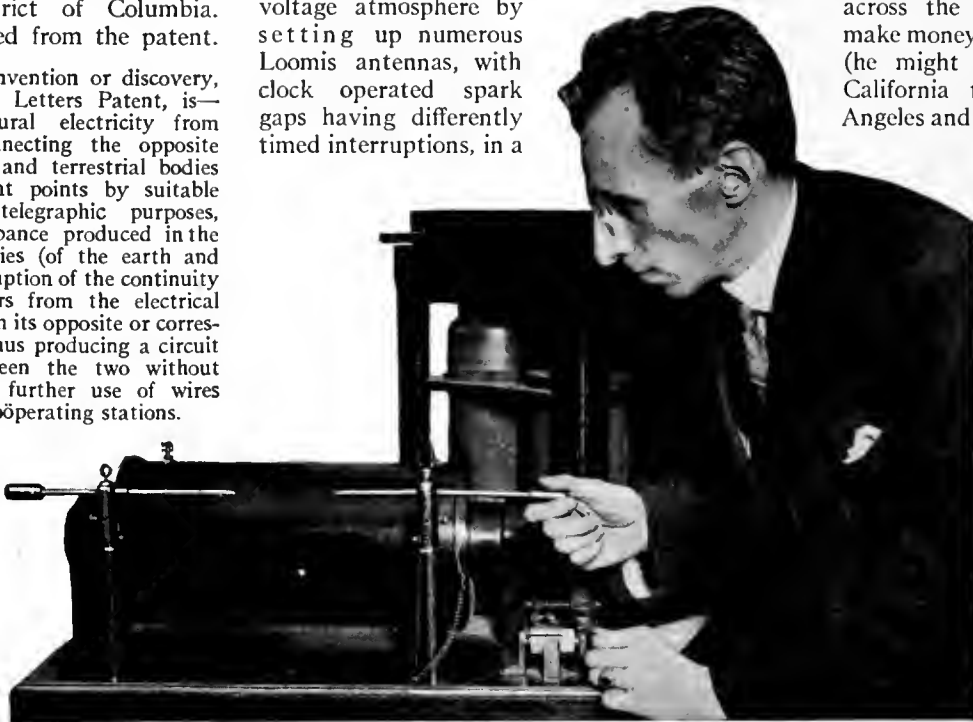

"HIGH POWERED" EQUIPMENT—IN 1903

The ten-inch induction coil which was standard during the early years of wireless as the transmitter. Nothing was simpler than the circuit used. About twenty volts was supplied to the primary of the coil and some eighty or a hundred thousand volts were produced between the electrodes the operator is adjusting. Ships and shore stations alike used the coils and sharp tuning was unknown. Those were the days when no one knew exactly what wavelength he was using and didn't care. The few wavemeters in existence were objects of curiosity in almost inaccessible laboratories



FIG. 1

A collection of modern tubes, nearly all of which are designed for the second audio stage where so much distortion due to overloading now occurs. The power tubes illustrated in this photograph are Western Electric 216-A, UX-112, UX-210, UX-120, UV-202, Cleartron, and Heliotron. The small "peanut" tube is the Western Electric "N" tube, and in the photograph are two tubes designed for resistance-coupled amplifiers, the Daven "MU-20" and the High Constron. Daven also makes a power tube known as the Daven "MU-6."

# Tubes: Their Uses and Abuses

How to Use the Standard and the Latest Tubes to Attain High Quality in the Radio Receiver—Some Little Known But Easily Applied Facts of Increasing Importance About Audio Amplification

By KEITH HENNEY

Director, "Radio Broadcast" Laboratory

THE development of the vacuum tube has placed in the hands of engineers and scientists—and radio listeners—one of the most versatile and useful devices that has resulted from man's ingenuity. The applications of the vacuum tube device are so diverse and so important that it is indeed the modern "Aladdin's lamp."

Vacuum tubes in the early days were not what they are to-day. Any one who remembers trying to hook up two of the old "tubular" tubes into a two-stage amplifier knows that. Amplifiers in those days were practically unknown. Tubes did nothing but oscillate, and quite often not much of that. All receiving was done by "beats," that is with the tube oscillating and the circuit tuned so that a slight difference of frequency existed between the incoming signals and those generated in the tube itself. Operators read the signals by these difference notes.

Tubes were not pumped (as highly evacuated) as hard as they are to-day. No two were alike. Some had grids on the outside of the glass bulb. Often amateurs used a complicated system of permanent magnets placed about the tube so that the electrons would be drawn from the filament at a faster pace. All in all, modern radio listeners have a lot to be thankful for.

Tubes to-day are fairly uniform.

If you buy a 5-volt tube you know that its characteristics will be such and such within fairly narrow limits. This means that you can interchange tubes with out "spilling the beans." Some manufacturers of tubes take particular precautions to have their tubes all alike and in RADIO BROADCAST Laboratory, a consignment of tubes from one manufacturer have been tested that were all alike—all twelve of them—and they were not specially picked, either.

Tubes in radio communication serve several special purposes, but to the listener there are two services which are of paramount importance, detection and amplification. And like all delicate apparatus, there are certain con-

ditions under which they must be operated to get best results. It is the purpose of this article to deal with those best operating conditions and to attempt to point out a few noteworthy ideas in the design of radio receiving equipment that utilizes vacuum tubes as the central piece of apparatus.

## HOW THE TUBE OPERATES

IT IS not necessary for the reader to know much of the theory of vacuum tube operation. It is sufficient if he knows that within the glass tube there are three metallic elements, a filament which lights up when you turn on the A battery, a grid which acts as a controlling valve for the plate current which flows from the third element, the plate, around through the B battery and back to the filament.

The filament emits electrons, according to the language of the physicist, but in ordinary terms, these building stones of all matter are actually boiled off the metallic filament when it is heated to a certain temperature.

These electrons are negatively charged and move toward the positively charged plate with a certain velocity depending on various controllable factors.

The grid is situated between the filament and the plate and is made of a mesh arrangement so that the electrons can go between its meshes

—SINCE the basic patents on the vacuum tube expired some months ago, there has been feverish activity among many manufacturers, and many new names have appeared on the market. The result is that a goodly number of experimenters are a bit at sea; tubes with capabilities quite beyond any of the previous well known types are available and many fans are groping for real information about them. The far sighted manufacturers who brought out the new tubes, the power type in especial, deserve much praise, for they have added infinitely to the acoustical refinement of radio. This article, we believe, contains some suggestions which will be highly valued by those experimenters who follow them. It is a plea, in short, for our audio amplifiers to be properly planned. By far the greatest number of radio experimenters use every tube they have in the conventional way: 90 volts on the plate and the rated filament voltage. The author, who by the way, knows a great deal about high quality in audio circuits, shows how the amplifier can be correctly planned—which appears almost to be a new idea.—THE EDITOR

on their way toward the plate. If the grid is negative it repels electrons and less plate current flows; if it is positive, it draws more electrons from the filament out into the space of the tube and the plate current increases. In this way the grid is essentially a controlling element.

DETECTOR THEORY AND PRACTICE

THE theory of detection is complicated and will not be described here. It is only necessary to say that 45 volts on the plate of the detector is about the correct value with modern highly pumped tubes; that the grid return should be connected to the positive side of the filament; that for grid condenser-leak detection, the proper values seem to be about .00025 mfd. capacity and two megohms, although other values may be used; that there is little use in using a C battery detector unless very powerful signals are to be

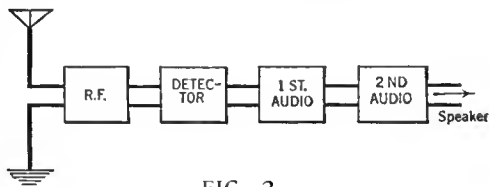

FIG. 2

Signals from an antenna go through several electrical devices before they finally emerge from a loud speaker. This illustration shows the path of these signals. At the input and output of each amplifier the voltages and power levels differ, increasing as the signal approaches the loud speaker

received, say in the second super-heterodyne detector.

Often a detector that will not work on 45 or even 22½ volts B battery will work very well indeed on 12 or thereabouts. If regeneration is not smooth, that is, if advancing the tickler, or the condenser in capacity feedback systems, is accompanied with growls and low frequency clicking noises, the trouble lies in too much tickler, wrong grid leaks, or too much B battery. The tube should slide into operation without fuss, and if it does not, something is wrong. With low loss receivers, not much tickler is needed. The higher the resistance of the coil into which regeneration is being introduced, the more tickler will have to be used and the more erratic will be the operation.

There is one point that may be mentioned here. It is a common statement that there is no necessity for low loss circuits in regenerative receivers since the addition of regeneration reduces the resistance of the circuit. Regeneration does reduce the effective resistance, making tuning sharper, and receiving more selective. If the receiver suddenly begins to oscillate after the regeneration has been set say when a crash of static comes along, or some loud signal, the

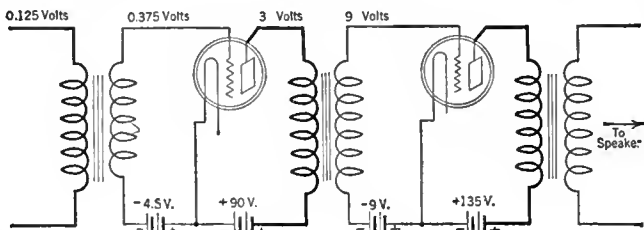

FIG. 3

A two-stage audio amplifier and the voltages that must appear at various points along the circuit if the full output of the last tube is to be delivered to the loud speaker. If lower voltages are delivered the volume will be "down." If more than nine volts peak are applied to the grid of the last tube, overloading will occur and a cone type loud speaker will, in popular parlance sound, "awful"

operator can look for a high resistance circuit in which the tuning is broad until much regeneration is added. Then it is time to read up on low loss circuits.

The use of low resistance grid leaks, say one half megohm, will improve the quality of music received but on the other hand, low valued grid leaks will cause some loss in volume—which may be made up in the audio amplifier.

Various methods of obtaining regeneration in a detector circuit have been described (see RADIO BROADCAST for October) and all produce the same results. Increased signal strength, increased selectivity, and, if it is pushed too far, decreased quality.

AMPLIFIERS: RADIO AND AUDIO

THERE is little that one can do to a detector tube or detector circuit beyond what has been mentioned above. When it comes to amplifiers, however, there is much to be said, and many false notions to be discussed.

There are two kinds of amplifiers in the usual radio receiver, those which are working at very high frequencies, and those which work at low audible frequencies, and there is a league and a half of distance between them.

In the first place there are two things to consider, voltage, and power amplification. These are two different things, and until quite recently little attention has been paid to the difference between them. Now that we have semi-power tubes appearing on the market from several tube manufacturers, we shall be able to plan our amplifiers with a little more engineering and a little less guess work.

Fig. 2 is a diagrammatic method of showing a receiver with its component parts. We shall begin at the loud speaker and work up toward the antenna circuit.

The speaker requires power—and there is a certain amount of power that is required by every good one to give a good, well-behaved sound. For example, the Western Electric 216-A tube, which until recently was the only semi-power tube available, has an output of .06 watts under the proper operating conditions, and if this is placed upon a good speaker, plenty of volume will result. Such volume will not be sufficient for a large auditorium, it will not be heard a mile or so up the street, nor will it drive any one out of the house—but who nowadays wants such volume?

Let us say, then, that a good signal requires .06 watts and since this figure represents power, the last tube in the receiver should supply power. Now there is an expression, due to Van Der Bijl, which amplifier designers seem to have overlooked, that says that the power output of any tube will be as follows.

$$\text{power} = \frac{(\mu \times \text{input voltage})^2}{8 \times \text{plate impedance}}$$

Now, using this formula, let us figure out the maximum power obtainable from several tubes under the usual operating conditions, namely, 90 volts B battery, minus 4.5 volts C battery, and assuming that the input voltage peak is just equal to the C battery voltage. In other words we are working

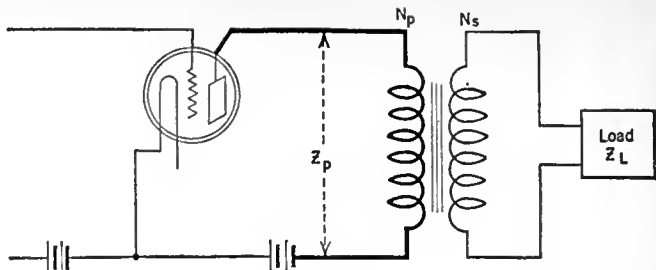

FIG. 5

Transformers are used to "match" impedances. In the case shown here, for maximum transfer of power from tube to load, the turns ratio of the transformer  $\frac{N_p}{N_s}$  must be  $\sqrt{\frac{Z_p}{Z_L}}$

the tube up to the limit of distortionless amplification.

Under these conditions the following table gives the power obtainable,

3-VOLT TUBE	5-VOLT TUBE	UX 112
.0066	.0135	.0184

Thus it is seen that none of the tubes ordinarily used will give sufficient output to operate a loud speaker at the desired level of .06 watts.

The following table gives the powers obtainable from tubes under conditions of greater input and plate voltages.

B-VOLTS	INPUT	5-VOLT	UX-112	216-A
90	4.5	.0135		
90	6.0		.0328	
135	9.	.058	.118	.059
157.5	10.5		.185	

From this table it may be seen that sufficient power is not obtainable for satisfactory reception with a 5-volt tube until 135 volts are used on the plate and until 9 volts are placed upon the input to the last tube. Under the same conditions, the newer 5-volt, one-half ampere filament tubes, such as the UX-112, and similar tubes for the same purpose, will deliver nearly twice as much power as is actually needed, and with 157.5 volts on the plate and 10.5 volts C bias will have an output that is still more favorable.

These figures mean that it will not be necessary to crank up a receiver to the top notch to hear the average level of an orchestra; and to endure distortion, or to turn down the set when a player bangs down on his kettle drums unexpectedly, or when the orchestra rises to a maximum output level.

In other words, a receiver properly operated with one of these semi-power tubes in the last

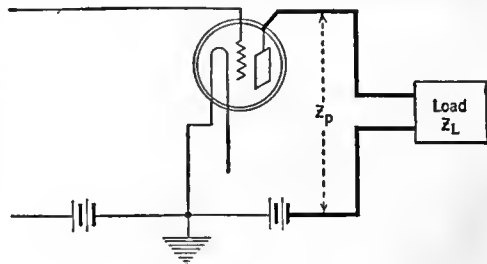

FIG. 4

The last tube in a receiver must deliver power to the load which is usually a loud speaker. If the impedances of the tube,  $Z_p$ , and the load,  $Z_L$  are alike, maximum power will be delivered

stage may always be somewhere short of the overloading point, and the range in volume, without the distortion due to overloading, will be much greater. For practically the first time in radio broadcasting reception it is possible to avoid overloading distortion without going to the bother of installing power tubes and high voltage



TABLE I

TUBE	USE	PLATE VOLTS	GRID VOLTS	PLATE RES.	POWER OUTPUT WATTS
WD-11	{ Amplifier Detector	90	4.5	14000	.0057
UV-199	{ Amplifier Detector	90	4.5	15000	.0066
UV-201-A	{ Amplifier Detector	90	4.5	12000	.0135
UX-112	{ Amplifier	135	9.0	11000	.058
		90	6.0	8800	.033
		112.5	7.5	8400	.054
		135	9.0	5500	.118
		157.5	10.5	4800	.185
UX-120	Amplifier	135	22.5	6600	.101
216-A	Amplifier	135	9	6000	.059
UX-210	Amplifier	90	4.5	9700	.015
		135	9	8000	.071
		157.5	10.5	7400	.105
		250	18	5600	.41
		350	27	5100	1.08
		425	35	5000	1.84
Daven MU-6	{ Amplifier	120	7.5	6100	.0625
Cleartron	{ Amplifier	120	7.5	6260	.0312
Goldentone	Amplifier	120	7.5	5570	.058

B batteries. Tube builders who have had the initiative to bring out these new tubes deserve a large vote of thanks from the part of the radio public that really enjoys high quality.

In Fig. 3 is the conventional two-stage audio amplifier with the voltages marked as they appear at various points, considering that 9 volts at least are to be used as a C bias on the last tube, and that transformers of 3 to 1 ratio are used, and that the amplification factor, "Mu", of each tube is 8. It is seen that .125 volts must appear across the primary of the first audio frequency transformer, this must be the output voltage of the detector.

At the present time, nearly everybody has his receiver too near the point where the C battery voltage on the last amplifier is exceeded by strong signals. On a cone speaker this is signalized by a peculiar rasping, scraping, or rattling, and the user of the speaker believes the fault lies there when the trouble really exists in his amplifier. No loud speaker can be operated at sufficient volume from a 3-volt tube without overloading. This fact cannot be avoided.

One method of avoiding the semi-power tube problem is to use two 5-volt tubes in parallel in the last audio amplifier, that is, with their grids and plates connected together. From the above formula, the resultant output power with negative 4.5 volts on the grid and 90 volts on the plate is .027 watts and with 135 volts B battery and 9 volts C battery, the result is .117 watts. In other words, a single UX-112 will equal two 5-volt tubes in parallel.

All of these figures assume that the detector is turning out .125 volts—and if it does not, of course the C volts assumed above will not be available, and the power output will drop.

IMPEDANCE CONSIDERATIONS

THERE are other considerations in the audio amplifier end of a receiver that are important. One is the impedances of the loud speakers used with respect to the plate impedances of the tubes used. The layman need not know what these terms mean, but it is not difficult for him to see their importance. Fig. 4 represents a tube working into a load of some sort, say a loud speaker. Now it is an axiom among electrical power workers that any device will put the maximum power into a load when the impedances of the two are alike. When these impedances differ, the power drops.

Now, the impedance of a tube varies with the B battery applied, dropping as the battery voltage increases. The impedance of a loud speaker is under control of the designer, he can make it have, at a given frequency, practically any desired impedance. Therefore, let him design it so that the impedance of the speaker and that of the tube are alike, or as an engineer would say, let them "match" the impedances. This sounds easy but it is not.

The difficulty lies in the fact that the impedance of the loud speaker differs with each frequency, so that the designer

must pick out some particular frequency and match his impedances there.

Suppose that a manufacturer desires to place on the market a very high grade loud speaking device. He makes a number of experimental models and finally finds one that seems to be worth producing. He measures its impedance at various frequencies, finding that at low frequencies it has a low impedance and at high frequencies it becomes very high in impedance.

Then he selects a number of people to listen to the device, people who know music and who have a feeling for tone value. He starts at the low frequencies, matches his speaker to the tube impedance at say 200 cycles by means of transformers, as in Fig. 5. Then he matches the impedances at higher frequencies, and asks his audience to say which of the many impedance matches seems the best.

Perhaps they decide upon a certain impedance, knowing that the answer must be a compromise, for if the device is matched at 100 cycles the tube will transmit to the speaker a maximum of power at 100 cycles but very little at 10,000 cycles, and vice versa.

For example, the nominal impedance of the 540-AW Western Electric speaker happens to be in the neighborhood of 4000 ohms, and for the best transfer of power from tube to cone, the output impedance of the tube should be about 4000 ohms. Thus the UX-112 tube with 157.5 volts on the plate has an impedance of 4800 ohms, a good impedance match, while a UV-199 tube with 90 volts on the plate has an impedance of 15,000 ohms, a terrible match—all of the low frequencies would be lost no matter how good the transformers are.

From the standpoint of quality then, tubes should be worked below the overloading point, that is below the place where the available C battery voltages are exceeded, the loud speaker should have the same nominal impedance as the power tube, and the output tube should have sufficient power output to actuate the speaker



FIG. 6

As shown in the table of tube characteristics in this article, one UX-112 will have approximately the same output as two UV-201-A tubes in parallel. In receiving sets such as the Freed-Eisemann illustrated here power tubes may be used in place of the two parallel tubes ordinarily used.

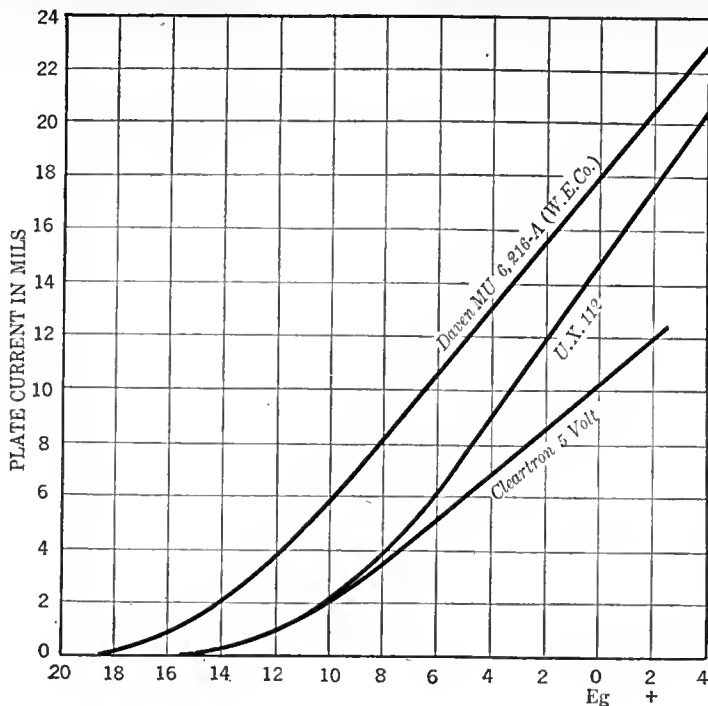

FIG. 7

Curves showing the relation between grid volts and plate current of three power tubes. These curves were made at a plate voltage of 120, and show that a C bias of about  $7\frac{1}{2}$  could be used on the Daven mu-6 and the 216-A while for the Cleartron, and the UX-112, a bias of about 6 would be required at 120 volts of B battery

without forcing. Goodness knows what the impedance of loud speakers now on the market may be. There is no standard, for there has been no standard in tubes. Many people try to work cone type speakers on 3-volt tubes, and it cannot successfully be done without some distortion. Manufacturers of speakers should set upon some value of nominal impedance, say 5000 ohms and stick to it. Otherwise some careful designer should bring out an output transformer which will connect a high impedance loud speaker with a low impedance tube, and a low impedance speaker with a high impedance tube.

At the present time, the best combination for a transformer-coupled amplifier seems to be a standard 3- or 5-volt tube for the first audio amplifier, and a semi-power tube in the last amplifier. Since the amplification of 5-volt tubes is considerably above that of dry cell tubes, those who wish the best in quality and volume should use the larger tubes. As a final tube, the UX-112, the 216-A, the Daven MU-6, the Cleartron semi-power tube, the Heliotron power tube—all are excellent choices for that last audio stage. And of course for good quality, good transformers must be used.

#### TRANSFORMER RATIOS

THERE are several strange ideas prevalent regarding the ratios of transformers. There is no reason why good transformers must be low ratio affairs. In fact one of the best transformers on the market has a comparatively high ratio and for several years before the present broadcasting era, the telephone industry had a high ratio transformer with an essentially flat characteristic.

The difficulty is expense, and until people will pay for high ratio, high quality transformers they will have to be content with low ratio high quality ones.

With regard to the overloading of tubes, there is no difference whether a high ratio transformer comes before a low ratio instrument or not. It is overall amplification that causes overloading, and it is seldom indeed that the first audio

of higher plate voltages, but at the same time it is more difficult to control such an amplifier. As a matter of fact, a five-tube set, with two stages of radio-frequency amplification which are working properly will have all the voltage amplification that can be handled. If a potentiometer controlled amplifier is used, and many of the tuned "r. f." sets use this means of stabilizing, a large B battery current will be drawn when the potentiometer is swung to the positive side. There is no remedy for this, since such sets cannot under existing patent arrangements use C batteries and cannot be neutralized.

#### RESISTANCE-COUPLED AMPLIFIERS

AS LONG as radio constructors were limited to the usual 3- and 5-volt tubes, resistance- and impedance-coupled amplifiers were not to be advised. Due to the high resistances used as coupling devices, the voltage actually on the plates of tubes is very low, and no amplifier tube will work satisfactorily unless a certain voltage is maintained on the plate. This meant that at least double the ordinary B voltages must be used.

High "Mu" tubes, however, are a distinct boon to resistance- and impedance-coupled amplifiers. Curves taken by Mr. G. H. Browning are illustrative of the effect of using these new tubes and may be seen in his article on the Browning-Drake receiver in this number of RADIO BROADCAST.

Owing to the very high plate impedance of these tubes, they will not act as power amplifiers at all, and in the third stage of a resistance- or impedance-coupled audio amplifier a semi-power tube should be used. To get the same amplification—and the same power into a speaker—from such an amplifier as is obtainable from a good two-stage transformer-coupled amplifier, at least three stages must be used, the last of which should be a semi-power tube as indicated before.

Unless large capacities are used as the coupling units, at least 0.1-mfd., the low frequencies will be dropped out and the user is no better off than if he had used transformers.

Two "high Mu" tubes have come to the

amplifier overloads. From the standpoint of quality, however, the prevailing system of having high ratio transformers first and low ratios second is wrong. High ratio transformers will probably have a lower primary impedance than will low ratio instruments. A detector has a high plate impedance while an amplifying tube has a much lower impedance. If these impedances are to be matched at all, the higher impedance transformer (low ratio) should come next to the detector.

#### RADIO-FREQUENCY AMPLIFIERS

IT IS probable that the standard practice of using 90 volts B battery and negative 4.5 volts C battery is about correct for radio frequency amplifiers. It is true that somewhat greater amplification will result from the use

Laboratory of RADIO BROADCAST which may be recommended. These are made by Daven and by Cleartron. The former are known as "MU-20" tubes and the latter as the "High Constron." Both have an amplification constant of 20, have proven to be very uniform, and have a plate impedance at 90 volts B of about 30,000 ohms. Daven tubes are designed to operate on 6 volts without the use of rheostats. Since storage batteries retain their voltage output until nearly discharged, the full 6 volts is obtainable.

These high impedance tubes cannot be used, with profit, in a radio frequency stage of present receivers. Their field is in the usage discussed above, and Mr. Browning's curves show conclusively that they are of great value in this connection.

#### OTHER POWER TUBES

THE UX-120, a dry cell tube to be used to feed into loud speakers, has an amplification factor of 3.3, a plate impedance of 6600 ohms, and should be used with a plate voltage of 135 and a negative C bias of  $22\frac{1}{2}$  volts. The power output under these conditions should be .1 watt which is sufficient for high quality high volume operation, but owing to the curved characteristic of this tube it is doubtful of this power output may be approached. This will be an excellent tube for use in super-heterodynes which at present use the ordinary 3-volt tube which has not the output required.

The UX-210 tube is essentially a power tube and should be operated from a source of alternating current by means of a step down transformer, as was described in November RADIO BROADCAST by James Millen. Only where considerable power is desired should this tube be necessary. In the Laboratory it has proved to be an excellent transmitting tube, and more than 30 watts have been applied to it without difficulty.

At the present time, the proper arrangement of tubes in a five-tube set seems to be as follows, 3- or 5-volt tubes for everything but the last where a UX-120, a UX-112, Daven MU-6, Cleartron 112, Heliotron power tube, WE 216-A, Seagull type P, or Goldentone, should be used. If more power is desired, two tubes may be used in parallel, two may be used in a push-pull arrangement, or the UX-210 type may be used.

In a future article the new Radio Corporation ballast and rectifying tubes will be described.

The data given in the table in this article must not be misunderstood. It gives the maximum undistorted power in watts that certain tubes will deliver under certain conditions, those conditions having to do with the plate voltage used and the variation in grid volts being applied to the tube. If these grid volts are not applied, less power will be delivered.

For instance, there is an idea prevalent, since the appearance of semi-power tubes, that the substitution of such tubes for standard 3- or 5-volt tubes will result in a marvelous increase in volume. Such is not the case although some increase will be noted due to the lower output impedance of these tubes over these in standard use. Under the same operating conditions, a standard tube and a semi-power tube will deliver about the same power. The great advantage of the newer type of tube is that it will handle more power, that is, a greater input voltage and corresponding greater output, than the 3- or 5-volt type. In other words, the substitution of a 112 type or 210 type tube will enable the user to use greater voltage amplification up to the last stage and by the proper use of C, and B batteries, distortion due to overloading will be less likely to result.

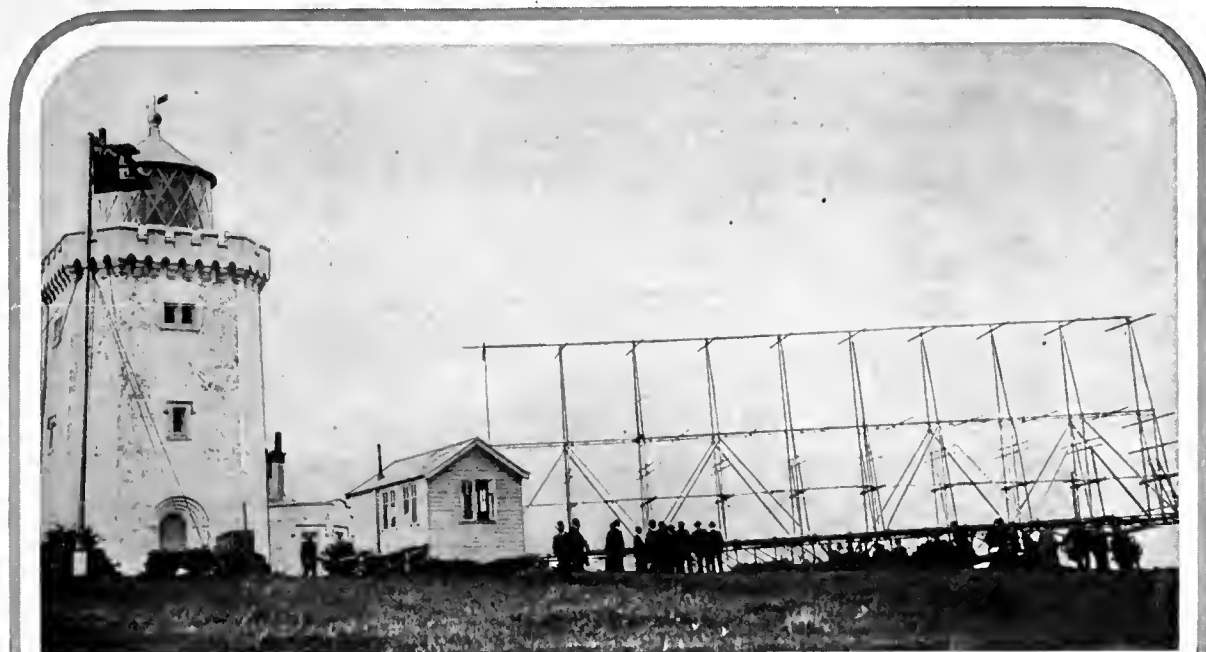

# THE MARCH OF RADIO

By *J. J. Morecroft*

Past President, Institute of Radio Engineers

## What Is the Matter With the Naval Radio Service?

ONLY a short time ago radio had one of the best opportunities in its history to prove its worth to the mariner in distress—and failed. It is not in a spirit of cynical criticism that we bring up this incident but rather with the purpose of inquiring whether something cannot be done to prevent similar occurrences in the future.

The whole country was enthusiastic several months ago over the idea of our naval aviators hopping from California to Hawaii. Three of the planes were to go, but due to mishaps only one made a serious attempt at the long flight. This trip had been planned very carefully and it seemed as if nothing could happen to prevent the goal being reached. Destroyers were used to mark the course and were ready to render assistance should the planes come to grief; every two hundred miles along the two-thousand mile course a destroyer or a supply ship was stationed to give the planes the proper direction and to record their progress.

The radio equipment of these planes was supposed to be of the very best. With a sending radius assumed to be in the hundreds of miles, and reliability of operation never before attained (as the description of the radio outfits specified), it was

confidently assumed that the operators of these seaplanes couldn't help knowing exactly where they were, and could keep in constant communication with the marking vessels. The radio signals were to be used for compass bearings as is the case every day with hundreds of ocean-going ships, and altogether the planes were considered as safe as though they were close to their own home port.

One of the planes had mishaps and had to give up the trip after covering a short distance, another never even started. The third flying boat however, *PN-9 No. 1*, in charge of Commander Rodgers, got well away and picked up the first of the marking ships almost on schedule. The wind was not quite as favorable as had been hoped, so that the speed was considerably less than that reckoned on. Thus the gasoline supply was not quite sufficient to cover the two thousand miles and Commander Rodgers decided to come down near the *Aroostook*, two hundred miles from the end of his trip, to renew his gasoline supply.

And now, probably the only time during his trip that the radio channel was really needed, it failed. The radio compass bearings should have enabled the *PN-9 No. 1* to proceed at once to her supply ship, but the plane missed her completely. The

compass bearings indicating that the *PN-9 No. 1* was south of the *Aroostook*, her commander flew north until his gasoline supply gave out and he had to drop to the ocean. The plane's position was then calculated by her commander as fifty miles north of the *Aroostook*.

Having thus failed in its important work of keeping the plane on her course, the Naval radio now scored an even worse failure. With no gasoline to run her engines, the only thing the Commander of *PN-9 No. 1* could logically do was to call for help and supplies. It is exactly in emergencies of this kind that radio is supposed to be the mariner's most useful agency, but this failure was nothing short of dismal. Only fifty miles from the waiting patrol ship, the *PN-9 No. 1* was for some inexplicable reason helpless as far as radio communication was concerned. And to add, to its ignominious failure, radio served to agonize the souls of the crew by letting them hear all of the radio messages with which the air was filled. Gradually, their receiving set told them, the searchers were giving up hope of finding them; each succeeding day their would-be rescuers were becoming more discouraged and evidently soon would give up the search. And all this time their rescuers were only a couple of hundred miles away!

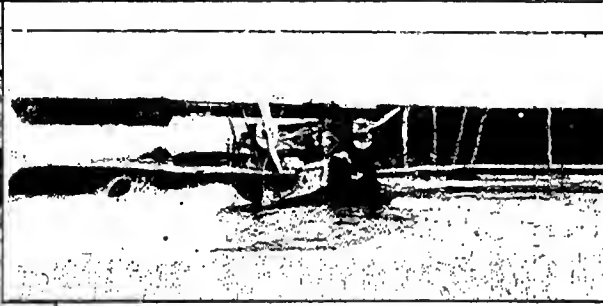

#### RADIO PICTURES OF THE CALIFORNIA-HONOLULU AIR FLIGHT

Sent from Honolulu to New York on Sunday, September 13, by the Ranger photoradiogram system. The distance is 5116 miles. Left: Commander John Rodgers of the *PN-9 No. 1* as he looked when he landed at Lihui, Kauai Island, after his rescue from the disabled plane shown in the view above. The ship was adrift for nine days, owing to failure of radio compass bearings when the ship was only about 200 miles from her goal. When she landed on the sea, there was no emergency transmitter to signal the rescue vessels. The operator of the plane was forced to hear all the conversations relating to the rescue work

There is no good reason why a single circuit regenerating receiver could not have been used as a transmitter for the short distance to be covered, if no other means were at hand. But why wasn't there a transmitter which would work if the plane was forced down? According to the plane's commander, a perfect landing on the ocean was made and nothing happened to interfere with the radio apparatus performing as it was intended to do. Why didn't it perform? Was there no emergency apparatus able to operate if the plane was forced down?

Favorable weather and fortunate winds enabled these trans-air travellers finally to reach land after nine days of hazardous drifting in their tiny craft. And with that loyalty to the service which the Navy officer feels to be his first duty, Commander Rodgers stated that "there was no failure of material at any time in the air or the water."

We are not under the restraint that

Commander Rodgers is, and we can say frankly that there was a failure, one of the worst that radio has scored. Some explanation should be forthcoming from those responsible in the Naval Radio Service for this blot on their reputation.

It transpired in the hearing which followed the disaster several years ago, when six Naval destroyers were wrecked off Point Arguello, that the compass bearings given to the leading destroyer by the Naval radio station were incorrect. The radio-weather intelligence furnished the *Shenandoah* on her recent disastrous trip was incomplete or entirely lacking—to which one might lay a large share of the blame for the failure of her navigating officers to avoid the storm which destroyed the ship. Listeners who have heard the way in which sos traffic has been handled recently around the New York territory have observed that the Naval stations have handled that traffic in a singularly inexpert fashion. Taken all in all, there are unmistakable signs that there is something radically wrong with the Naval Radio Service. Who is to blame?

#### National Association of Broadcasters

ALTHOUGH the average broadcast listener probably knows nothing about it, their purveyors of entertainment have been organized for some time. The National Association of Broad-



#### THE NEW MARCONI DIRECTIONAL BEAM STATION AT DORCHESTER

About 120 miles from London. This is a new and exclusive photograph published for the first time in the United States. The picture shows five of the masts which are 277 feet high, and 750 feet apart. The masts are at right angles to the direction in which communication is to be established. The cross arm at the top is 90 feet across. The antenna wires, which are not yet in place, will be attached to triatics at one end of the cross arm and the reflector wires to the other. The distance between the antenna wires, reflector wires, and the number and distance apart of the separate wires making the antenna and reflector will depend on the transmitting frequency used. The installation shown is expected to communicate with New York. Others now in process of construction and test will connect England with Australia and the Dominions. On a recent four-day test, Senator Marconi announced that he had been in uninterrupted communication with Australia, using the beam system

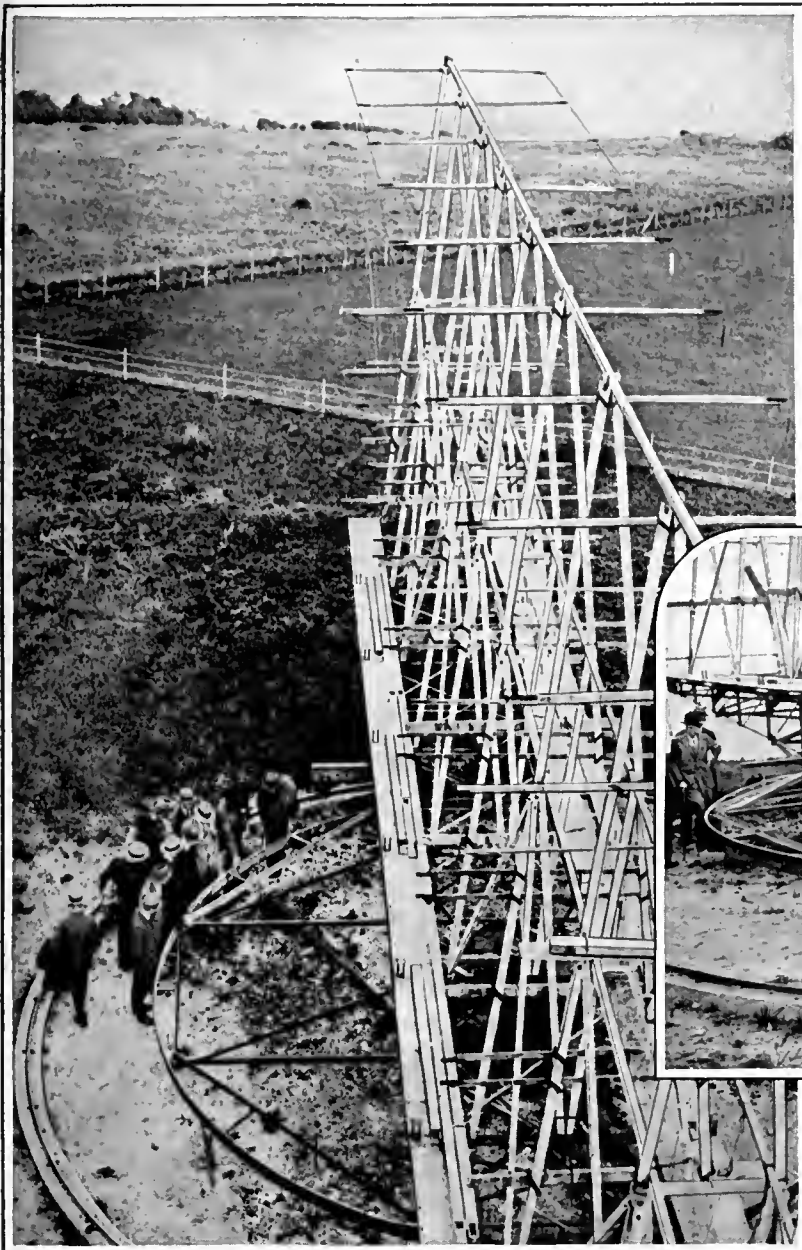

*Be It Resolved* that, it is the sense of this meeting that any agency of program censorship other than public opinion is not necessary and would be detrimental to the advancement of the art."

### More Information on Super Power

AS THE first experiments on higher broadcasting power continue, the public is beginning to see that those engineers who advised caution in drawing conclusions as to what effect this increased power would have were wise. Many were the broadcast listeners who said 50 kw. for one station would blanket all that part

#### DETAILS OF THE RADIO "BEAM" LIGHTHOUSE AT SOUTH FORELAND, ENGLAND

Senator Marconi recently conducted tests with this installation from his yacht *Elettra*. The beam flashes signals ac-

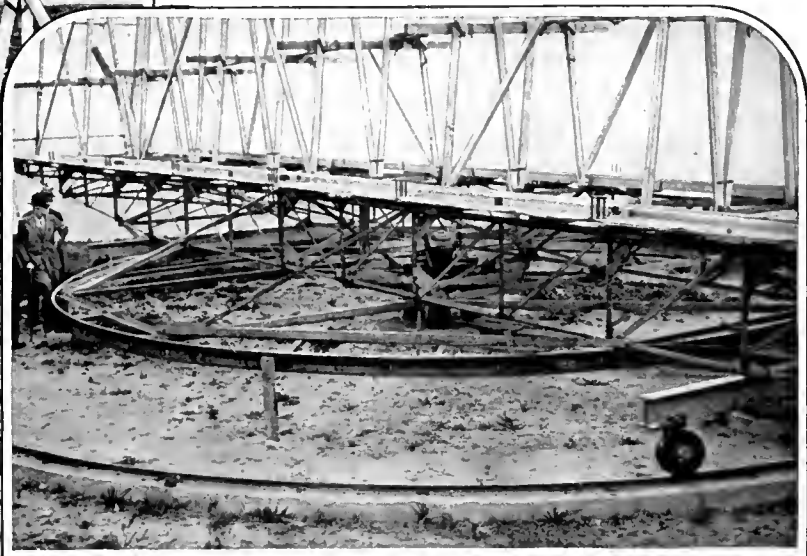

ording to a schedule from all points of the compass. The loud speaker announced a letter at intervals, and the position of the ship was determined according to the letter heard. By means of a chart, it was possible to tell just where the ship was. The frequency was 49,970 kc. (6 meters). The heading for this department this month shows the lighthouse and the revolving antenna and this view shows the details of the antenna

casters had its annual meeting this month and its transactions are indirectly of interest to us all. The object of the society is to promote generally the welfare of our broadcasting stations through various co-operative arrangements.

It was started by a small but active group in the Middle West, with the able Mr. Paul B. Klugh as Executive Chairman. Its activities proved so worth while that the membership rapidly increased and now it bids fair to justify its name.

Among the members elected at this meeting was WEA, representing the American Telephone and Telegraph Company. When this company goes into an association of this kind it is undoubtedly a sign of its promised or accomplished success.

The question of broadcasting copyrighted material has been more troublesome to the National Association of Broadcasters than any other problem in their operations. At first the organization was averse to paying royalties for the privilege of putting music and songs on the air (the copyright law, of course, contains no pro-

viso for such an exigency). Now this association has changed its point of view. Among other resolutions passed was one which would put the broadcasting of copyrighted material on the same basis as the mechanical reproduction of such pieces (by player piano and phonograph) in so far as royalties are concerned.

Another matter which received consideration was that of the method of introducing the paid features of the program. One of our congressmen has advocated the complete separation of paid channels from the others. That attitude seems unnecessary and inadvisable. The broadcasters took this view of the matter and decided that paid programs could be "gently" introduced.

On the question of censorship, the society declares that "Whereas it is universally agreed that the success of radio broadcasting is founded upon the maintenance of public good will and that no broadcasting station can operate successfully without an appreciative audience, and Whereas the public is quick to express its approval or disapproval of broadcast programs

of the broadcast range, that it would be impossible to receive other stations which sent signals of anywhere near the same frequency. Some months ago we got several petitions (with requests to sign) directed to Mr. Hoover, requesting that he prohibit broadcasting stations using a greater power than 5 kw. The petitions stated what troubles were to be encountered if the Department did not block this anticipated move by the "Trusts."

Schenectady has carried on many tests with a 50 kw. outfit, and at the time this is written, very few complaints have been received. Many replies have been received to questionnaires sent out, and they are still being classified and compiled. It is interesting to note that the public must be depended upon to answer the question as to how much power the broadcasting agencies should use. All questionnaires received should be carefully answered, for it is the facts in the compilation of these answers that Mr. Hoover will depend on to determine his future policy regarding high power stations.

Although many of the letters received by WGY are contradictory, the average listener seems to think that a 50 kw. signal is two or three times as loud as a  $2\frac{1}{2}$  kw. signal. In the recent tests, the two powers were alternated so that repeated comparisons could be made and but few of the reports say that one signal is more than ten times as strong as another. As a matter of fact, theory would indicate that the 50 kw. signal is twenty times as strong as a  $2\frac{1}{2}$  kw. signal, yet most of the listeners say it is about twice as strong. Probably the signal is actually twenty times as strong and the factor ten by which the average listener misses the truth is due to his lack of skill in comparing noises of different strengths.

The unexpected absence of complaint regarding interference by the high power channel has encouraged the General Electric engineers to continue their tests and the Department of Commerce has given WGY permission to use 50 kw. regularly on Saturday and Sunday evenings. If this much power is found to give to the broadcast listeners more trouble than benefit it will be discontinued, but it is almost sure that such will not be the case. A few listeners near the station who want to hear other stations thousands of miles away, whose frequency is nearly the same as Schenectady's, will of course report interference. This can be predicted without any further tests. But as radio broadcasting develops the complaints of the distance hound will fall upon less sympathetic ears. High

quality reception for the most listeners is what radio must eventually supply and increased power, properly controlled, will help in the solution of this problem.

### Canada as Our Instructor

**WE** MUST congratulate our Canadian friends on the way their governmental radio activities are conducted. It has been noted before in these columns that many radio questions were tackled in an intelligent and reasonable manner by our northern neighbors, even though some of their procedure (such as the licensing of receiving sets at one dollar a year) may not meet with our approval.

There has just come to hand a pamphlet put out by the Radio Branch, Department of Marine and Fisheries, Ottawa, which takes up the question of regenerative receivers. It is a circular letter addressed to all broadcast listeners and is written in a manner which will appeal to the average non-technical man. The letter starts with the paragraph "When using a receiver of the regenerative type for the reception of radio telephone programs, please avoid increasing regeneration to the point at which the receiver begins to oscillate, otherwise you will cause interference with neighboring receiving equipment." *Are you doing your best to observe this?*

The letter then proceeds to give an elementary, but clear and correct analysis of what regeneration is and why it causes interference, ending with easily followed instructions as to how to avoid spoiling neighbors' reception. With the government list of listeners available, as a result of the licensing feature of radio reception in Canada, this circular should reach the owners of nearly all the radio sets in that country and should do a deal of good.

### The Facts About the Farmer and Radio

**T**HE benefits which radio confers on the farmer have been represented to him repeatedly, but it is a fact that no one has really known whether the average farmer profited by broadcasting or not. A recent survey by the Department of Agriculture among the country's farms yields the information that there are 553,003 sets on farms, not as many as we had expected. This represents only  $8\frac{1}{2}$  per cent. of the country's farms, so there is still a large virgin market for the active radio manufacturer.

A questionnaire was sent out and the returns for the State of Pennsylvania have been sent us by Mr. George F. Johnson of the Department of Agriculture at Harrisburg. Of 343 answers received, two thirds used tube sets with loud speakers. To the question "Have market reports ever made or saved you money?" exactly half answered "Yes." and half "No." We hasten to encourage the promoter of "radio for farmers" after this answer, because while it looks at first as though radio was not functioning very well here; that is really not the significance of the return. That fifty per cent. of the farmers saved money from the information conveyed over the radio channel is incontrovertible evidence of its utility.

### The Month in Radio

**E**NGLISH employment agencies are finding that domestic help appreciates radio possibly even more than does the mistress of the house. Basting the roast beef in tune with the wedding marches, or washing dishes to the time of modern jazz proves to be so appealing that the agencies are said to be actually classifying the vacant positions as radio and non-radio, much to the detriment of the latter.

**T**HE first attempts experimentally to determine the proper allocation of frequencies to the various European stations resulted in ethereal pandemonium,

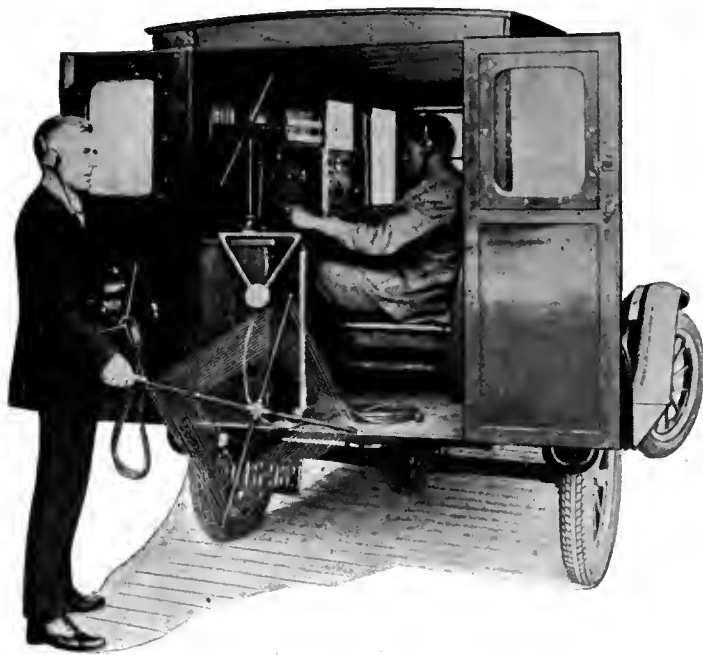

#### HOW THE CANADIAN RADIO SERVICE HELPS THE LISTENER

The "Inductive Interference" car maintained by the Radio Service of the Canadian Government. The annual license fee of one dollar, paid by every Canadian listener is used to maintain a corps of inspectors. A specially trained "induction squad" operates with this car to locate interference hard to detect by the ordinary methods. The car is especially made for this purpose, with a body of insulating material and carefully screened ignition system. Two special super-heterodynes, several portable receivers, a sledge hammer, condensers, and chokes form the equipment of the trouble car. The chokes and condensers are applied to cure trouble when found. The sledge hammer is often used to tap electric light poles in a suspected territory, and the trouble is quickly located by a listening inspector





© Harris &amp; Ewing

SENATOR C. C. DILL

Washington; United States Senator for Washington

*"The organization of a Government Commission on Communications to act for the telephone, telegraph, and radio, such as has been proposed, would probably end in disaster for broadcasting. It would be the beginning of the end of freedom of action in the radio business. I also wish to emphasize the necessity of immediate action on the part of the United States Supreme Court to arrive at a decision regarding the broadcasting of copyrighted musical numbers. If it is decided that such broadcasting is done for profit, and therefore a fee is due to the publishers of the music, I intend to introduce a bill to regulate the payments, so that radio broadcasting will not be at the mercy of any one group of men."*

according to a dispatch from London. About sixty stations going at once in an expanse of territory perhaps less than a quarter the area of our country proved too much. The interference was truly international. Newcastle, England, heterodyning with Gratz, Austria, and Norway stations beating with some in England, Germany and France, show us what a difficult question the Europeans have compared to ours. The radiophone center in Geneva was notified of all the interference and in the next test period changes will be made to keep the interfering stations farther apart in frequency.

THE research laboratory of the Westinghouse Company announces that the metal, thorium, is now available in such quantities that the filaments of vacuum tubes may be made of pure thorium instead of thoriated tungsten as is now the practise. The present tubes have a layer of thorium on the surface of tungsten filament, the layer being only about one atom deep. If the filament is improperly used, this thin layer of thorium disappears and the electron emission practically stops, the tube is useless. By considerably overheating the filament, without B batteries, a new layer of thorium will appear, this new

thorium diffusing to the surface from inside the filament.

Now, it is announced, solid thorium filaments will soon be available. This is a real advance because the possibility of the disappearance of the thorium atom-deep layer no longer threatens. The new tubes will very likely have much longer life than the present ones and not be so sensitive to improper adjustments.

A RECENT discussion in the semi-popular press, having to do with the use of super-power, ventured the statement that if a 5 kw. station was audible on a crystal set at twenty-five miles distance, the 50 kw. station would be audible on the same crystal set for a distance of "several hundred miles." It seems that if we interpret "several hundred" as five hundred miles, the power of the 5 kw. station would have to be increased to at least 250 kw. to increase the crystal set range as much as the writer suggested—and then it would probably fall short. Schenectady's tests should soon give us some reliable information on this point.

ACCORDING to the Department of Commerce, Japan's long distance radio telegraph stations are to pass from the control of the government into the hands of a private company which expects to erect two new stations in addition to the two now in operation and that when their four stations are in operation the company will communicate directly with the United States, Germany, and France. With the 50 kw. of power which the new stations are to have it seems very unlikely that signals can be sent directly to Europe except under most favorable conditions. Most of the time one or two relay stations will undoubtedly be required if any reliability is to be obtained.

### Interesting Things Said Interestingly

POWELL CROSLY, Jr. (Cincinnati; president Crosley Radio Corporation): "Very few broadcasting stations are operating with any direct profit. No broadcasting station in the country is making money to-day. Some handle indirect advertising with some source of revenue; so far, I believe, no stations have been able to meet expenses with this income. Our own revenue at WLW from this source would not pay for the direction of the studio. We have a large investment in broadcasting equipment—whether it is profitable for us to broadcast is a question; whether the good will created by a broadcasting station justifies its continued existence is merely a matter of opinion. No one can check the results. If all broadcasting stations face an additional expenditure of from \$5,000. to \$50,000. per year, due to the royalties imposed by the Society of Composers, Authors and Publishers, and perhaps more, because no limit has yet been set—how many of these stations will continue? Imagine the feelings of a man who appreciates the serious-



CARDINAL HAYES

New York; Speaking at the opening of station WLWL:

*"Among the most recent and wonderful gifts of science comes the radio. As Cardinal Archbishop of New York, I congratulate the Paulist Fathers upon the great work they have undertaken in opening up station WLWL. I congratulate also the people of this immense city and of this whole country of ours upon the inauguration of an enterprise so admirable. May I add that in the building of this station, the Paulists have shown themselves worthy sons of their founder, for nothing was more characteristic of the first Paulist, Isaac Hecker, than his readiness to utilize every new instrument of good. How his noble soul would rejoice to witness this scene, the dedication of the twin towers of steel that overlook the Paulist Church here at Fifty-ninth Street, as an agency for the spread of truth and wisdom. We who employ radio are responsible for our use of it. We must take care that we use it not for harm. But, further, we are strictly bound to use it for good, to make it fruitful. Whoever would be great, must serve. He who has power must turn it to the welfare of his fellows."*

ness of this situation, playing a gambling game in which no limits are set—where the more he pays the more he will have to pay—and you will appreciate how serious the situation is."

GOVERNOR ALFRED E. SMITH (Albany, New York): "Radio broadcasting has revolutionized political campaigning. It makes it possible for a candidate to reach the by-ways of politics. The stay-at-home gets your message as clearly and intelligently as the man who is able to come out to the meetings. A great event can be recorded at the fireside. The opening of the extraordinary session of the New York State Legislature this year is an example. It brought to the people young and old an important lesson in civics and gave them exactly the procedure which occurs when a session of the Legislature is opened. Radio gives you the widest possible audience and also the benefit of public opinion. I have had occasion to use the radio on many important occasions including my inauguration as Governor and in making an appeal for public support of important and vital policies. Just as it has served my needs and opened up a tremendous avenue for political education, I am glad to have the opportunity to say so to the radio public."

# A Five-Tube Receiver of Dual Efficiency

A Late Development of the Famous Browning-Drake Receiver Employing Impedance-Coupled Audio Amplification Producing the Highest Quality—Some Valuable New Data on Radio-Frequency Transformers and a New Method of Balancing Them

By GLENN H. BROWNING

**Q**UESTIONS are frequently being asked concerning the necessary requirements of the ideal radio receiver. The answer pictures a set which is sensitive enough to receive great distance, gives perfect reproduction of the program being broadcast, tunes sufficiently sharp to separate transmitting stations, does away with interference, and accomplishes all this without batteries, tubes, or other trouble making devices. At the present time, our ideal seems far from the realm of realization, but at least we may take a step in the right direction, by scientifically investigating radio and audio frequency amplification.

The receiver to be described, which consists of one stage of balanced, tuned radio frequency amplification, regenerative detector, and three stages of impedance-coupled audio amplification, is still far from perfect, but it is sensitive enough to do DX work, selective enough to cut through locals, is properly designed for good quality reception, and does not radiate.

Let us consider the component parts separately. The tuned radio-frequency transformer is probably the most important part of the receiver, for into its development went almost a year of theoretical

and laboratory work by Mr. F. H. Drake and the writer, with a result that a piece of apparatus was designed, which gave almost 90 per cent. of the amplification predicted by mathematical calculations.

Several interesting discoveries were made during this time, among which was the fact that the "turn ratio" of a tuned radio-frequency transformer was not so

regeneration is present in any radio-frequency amplifier to a greater or less extent, and the necessity of providing a method of controlling it arises sooner or later. A little experimenting showed that greater signal strength could be obtained by balancing the radio tube and regenerating on the secondary of the radio frequency transformer, rather than regenerating directly on the antenna tuning system. The former course, besides giving greater signal strength, has the added advantage that it does away with any radiation tendencies the receiver might otherwise have.

## SELECTING THE AUDIO AMPLIFIER

**I**N CHOOSING an audio amplifier for the circuit, some experimenting was necessary, as one can use

transformer, resistance-, or impedance-coupled systems with varying results. Two stages of, say, 4 to 1 transformers will undoubtedly give sufficient volume, but the quality or naturalness of the received program must, in some measure, be sacrificed.

Three stages of impedance-coupled amplification has as good quality as resistance, and, if properly built and operated, gives greater volume and does not require an abnormal B battery voltage. It was con-

**A**LTHOUGH Mr. Browning has made few fundamental changes in the original design of the justly famous Browning-Drake receiver which was originally described in RADIO BROADCAST for December, 1924, the reader will find that the receiver described here contains some distinct improvements which place this model in the vanguard of current receiver design. The improvements are in the audio circuit, and impedance-coupled amplification has been chosen. The four-tube model of the Browning-Drake receiver does frequently overload, but the set described below is almost free from that disadvantage. In this article, the author presents some interesting data on comparison between transformer-, resistance-, and impedance-coupled amplification, and suggests a new method of balancing the radio-frequency transformer. It should be read with much interest.—THE EDITOR.

important as the resistance of the secondary circuit, and the relation between primary and secondary. It was also found that any capacity between these two windings tended to decrease the efficiency, so that the final design consisted of a "bunched" primary winding coupled closely to a low resistance secondary coil. Having designed the radio frequency part of the circuit, the question of regeneration was then encountered. As most radio fans know,

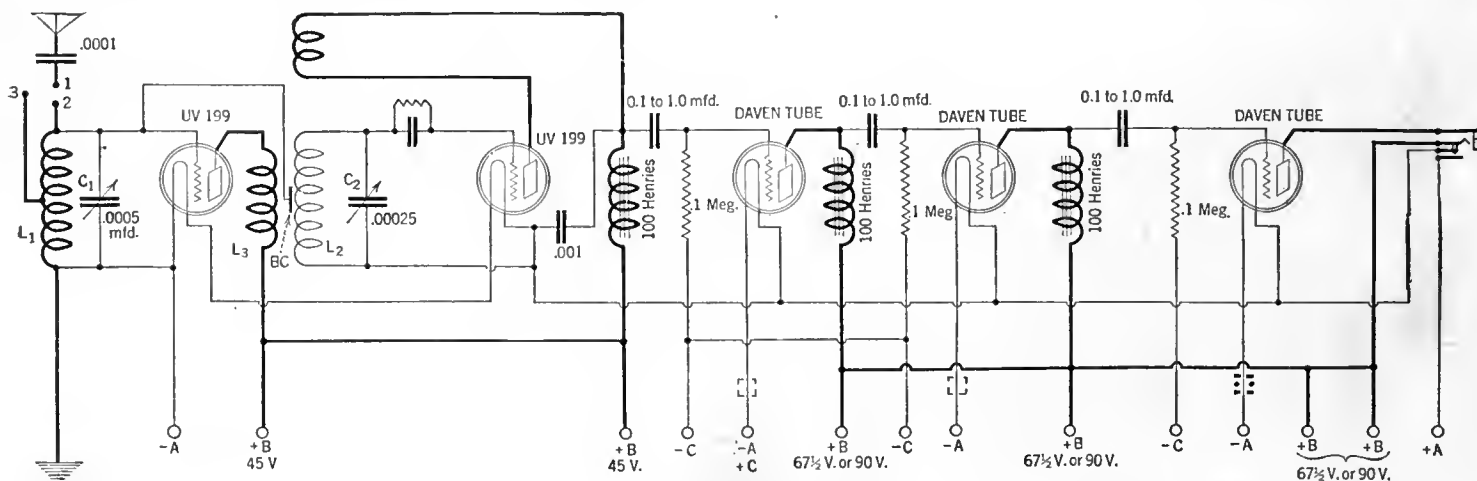

FIG 1

□ 1/4 Amp. Ballast for 5 Volt Tubes  
 ■ 1/2 Amp. Ballast for Power 5 Volt Tubes

The schematic diagram of the circuit employed in the receiver. The several battery terminals of similar markings are paralleled and connected to the terminal of the indicated polarity of the battery in question. For instance, there are four minus A posts. This group is connected together as one terminal, thence connecting to the proper battery. The same holds true of the two plus B 45-volt terminals, and the three plus B 67 1/2-volt or 90-volt terminals. However, in the case of the minus C battery terminals, the last audio stage will require more voltage than the first two



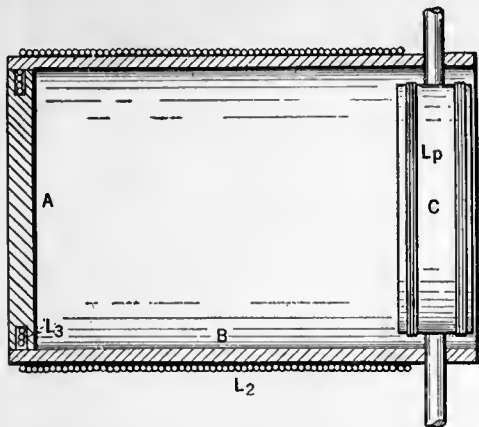

FIG. 2

Details of the winding of the radio frequency coupler. L<sub>3</sub> is the primary; L<sub>2</sub> the secondary, and L<sub>p</sub> the variable tickler coil. The actual winding specifications are contained in the accompanying article

sequently chosen for the receiver to be described.

For those who are interested in laboratory measurements, a comparison between the three systems is shown in the accompanying chart, where signal strength is plotted for frequencies ranging from 100 to 10,000 cycles per second. It will be seen that the more constant the amplification for the frequencies shown, the better is the quality of the received signals.

The conclusion to be drawn from this data has lead us to choose three-stage impedance-coupled amplification with high-Mu tubes.

The parts listed below were used in building the set. Whether or not the builder follows the exact list given, he will need the parts listed below or their equivalent.

One panel—21 x 7 inches.

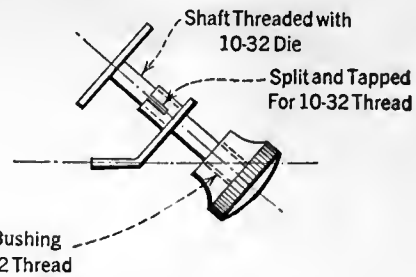

FIG. 3

Shows the mechanical arrangement of the balancing condenser plate and mount. It is to be mounted on the sub-panel in the rear of the radio frequency secondary coil

- One sub-panel (bakelite) 18 x 7 inches.
- One National Kit (containing the two variable condensers and Browning-Drake coils.)
- Five Na-ald sockets (2 UV-199 and 3 UV-201A).
- One Daven Leakandenser (the leak should have a resistance of 6 to 8 megohms.)

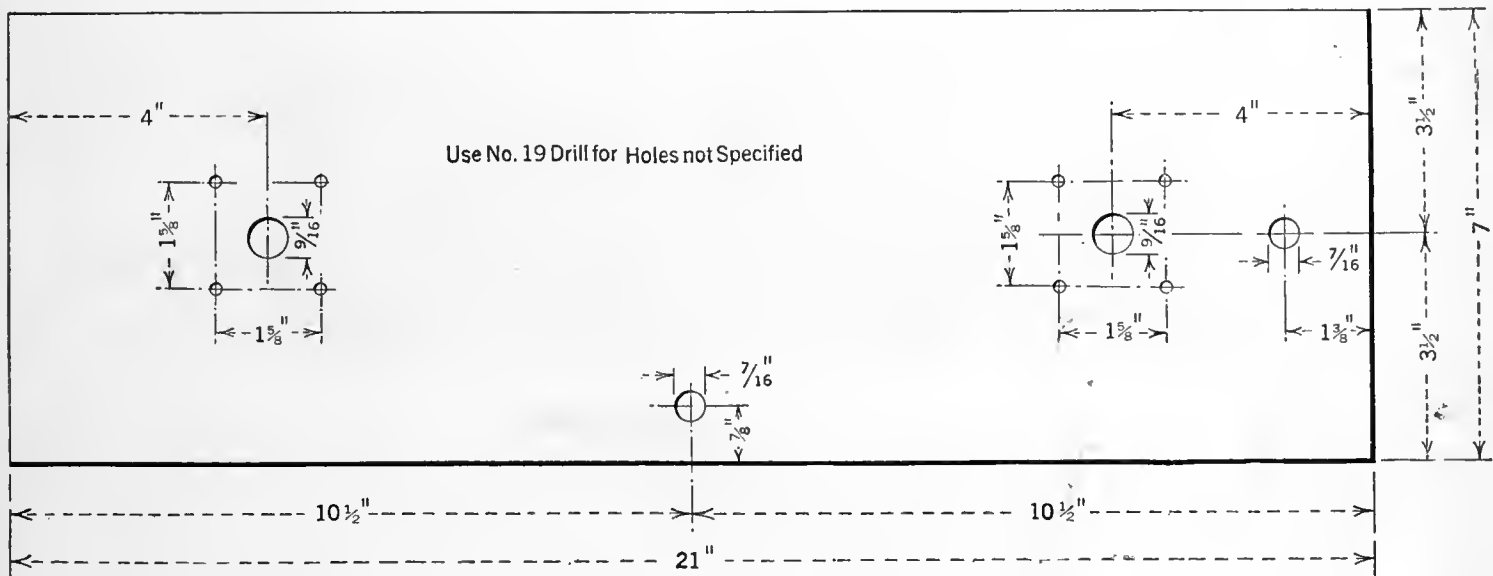

FIG. 4

The panel layout. There is room enough between the two tuning condensers to include a filament voltmeter which would not only add to the appearance of the receiver, but prove exceptionally advantageous in knowing the value of voltage delivered to the tubes



RADIO BROADCAST Photograph

FIG. 5

Looking down on the sub-panel, the position of the balancing condenser may be observed. Much of the wiring is below the sub-panel

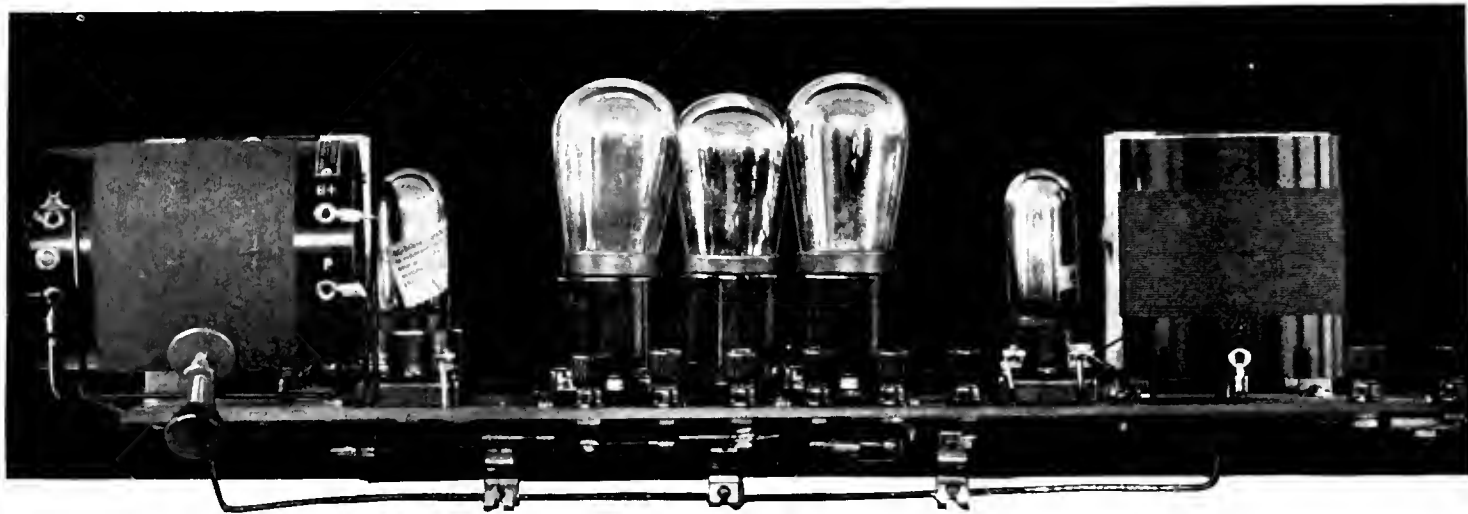

FIG. 6

RADIO BROADCAST Photograph

The simplicity of assembly is evident from this view. Note that the two coil units are at right angles to each other and on the same plane. This is necessary to prevent uncontrolled oscillation

Three Davent  
megohm grid leaks,  
and mounts.

Three 100-henry  
National chokes.

One Yaxley filament  
control jack.

One .001 mfd. fixed  
by-pass condenser.

One .0001 mfd. fixed  
condenser.

One balancing de-  
vice.

Nine binding posts.



FIG. 8

RADIO BROADCAST Photograph

The panel appearance of the completed receiver: simplicity itself

Fig. 1 shows the schematic diagram of the circuit used. The antenna tuning coil  $L_1$  consists of 46 turns of No. 20 d.s.c. wire on a three-inch bakelite form with a center tap taken off. The radio-frequency transformer, commercially familiar as the "regenerator," consists of three windings, a primary, a low resistance secondary, and a rotor coil. The details of its mechanical

construction are given in Fig. 2. The primary,  $L_3$ , consists of 24 turns of No. 28 or 30 d.c.c. wire, wound in a groove and placed at the low potential end of the secondary coil (under the first few turns of the secondary at the filament end). The secondary,  $L_2$ , is a single-layer solenoid made by winding 75 turns of No. 20 d.s.c.

rotor coil  $L_p$  is made up of 20 turns of No. 28 d.s.c. on a  $2\frac{1}{2}$ -inch form and so mounted that it may be rotated with respect to the secondary of the tuned radio-frequency transformer. The condensers chosen to tune the two circuits are of such construction as to separate the high frequency (short wavelength) stations considerably

wire on a three-inch bakelite tube. As has been mentioned before, the resistance in this circuit is important, and a great quantity of data has been collected which would indicate that the resistance of a single-layer solenoid is somewhat lower than those wound in a so-called "low loss" manner. The

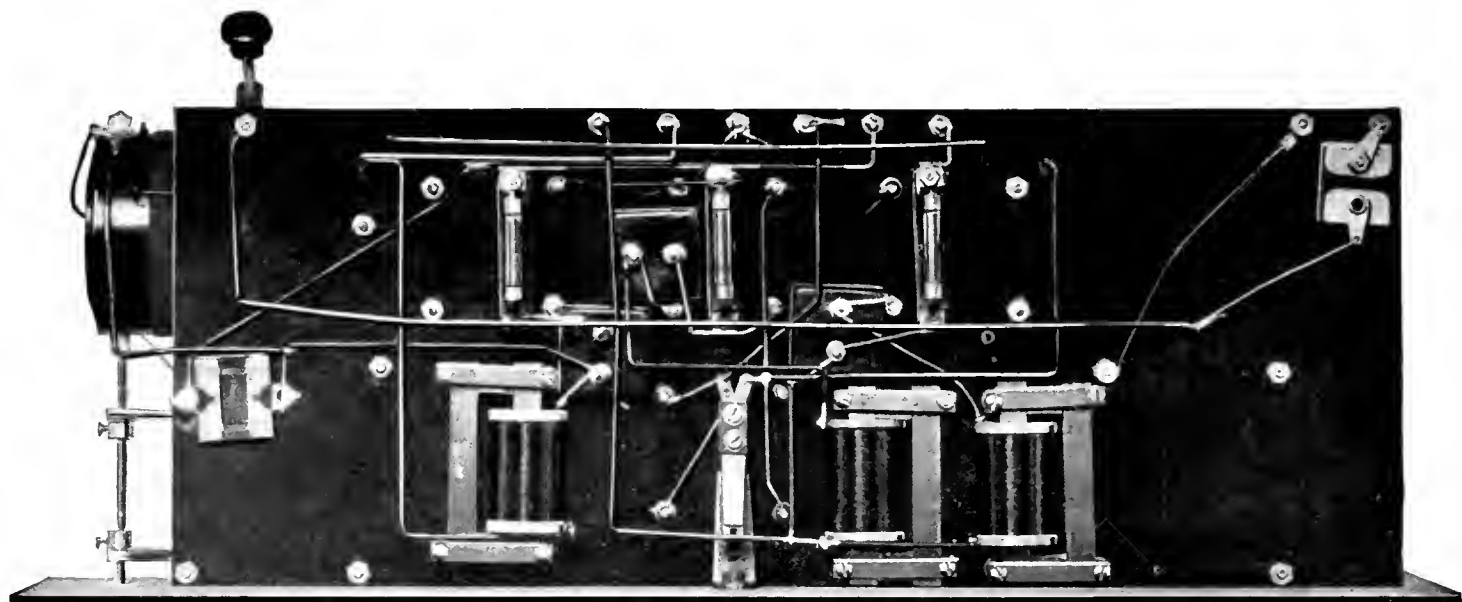

FIG. 7

RADIO BROADCAST Photograph

An under-view of the sub-panel where most of the wiring is placed. Convenient holes in the sub-panel allow the passage of wires connecting parts above the sub-panel with those below it

more than the ordinary condenser, and their sizes are such as to cover a frequency spectrum from 600 kilocycles to 545 kilocycles (200 to 550 meters).

The construction of the choke coils is not described because of the difficulty of making them at home. The National 100-henry choke was used in the model described. However, any standard choke coil for audio frequency work may be employed, such as those made by Acme, the General Radio Company, AmerTran, and Thordarson.

CHOICE OF TUBES

IN EXPERIMENTING with the receiver, it was found that a UV-199 was much easier to balance than the larger tubes, and was consequently used as the radio-frequency amplifier tube. As most fans know, a UV-199 is also a good detector, so at the suggestion of Mr. Arthur Lynch, the two UV-199 tubes were put in series and three Daven six-volt tubes employed so that the set operates directly from a six-volt storage battery without the use of rheostats. Two Daven MU-20 tubes may be used in the first two stages of impedance with a MU-6 in the last stage. The constructor may use other tubes by placing the correct filament ballast such as Amperite, Brach, or Daven type in the battery leads of the respective tubes. A five-volt, 1/4-ampere tube would take a 1/4-ampere ballast, and a five-volt, 1/2-ampere tube would take a 1/2-ampere ballast, etc. The new power tube, UX-112, may be used in the last audio stage with about 135 volts on the plate and 9 volts C battery. A separate C battery binding post is provided so the last audio tube may have an independent bias battery. When the MU-20 tubes are employed in the two intermediate stages of audio, little or no bias is needed with 90 volts plate battery, but when higher voltages are used a C battery of 1 1/2 to 3 volts should be employed

for good quality reception.

Forty-five volts is recommended on both the radio-frequency amplifier and detector, as this voltage has been found more efficient on the detector and sufficient for the radio frequency tube. With 45 volts on a radio-frequency amplifier, no C battery is needed and the grid return is run directly to the negative side of the filament.

In laying out the apparatus so that the set would be compact, the tuning condensers are placed symmetrically on the panel with the tube sockets arranged as shown in the photograph, the radio frequency tube being the one on the extreme left with the detector on the extreme right, and the audio tubes between the two.

CONSTRUCTION DETAILS

THE balancing of the first tube is accomplished by placing a 7/8-inch metal disc, connected to the grid of the first tube, in the rear of the radio frequency transformer (about in the middle of L2) and moving it toward or away from the secondary winding. This method of balancing, though not generally known, is simple and effective. The details for constructing this balancing device are shown in the accompanying diagram, Fig. 3.

The drilling template for both front and sub-panel are shown, together with

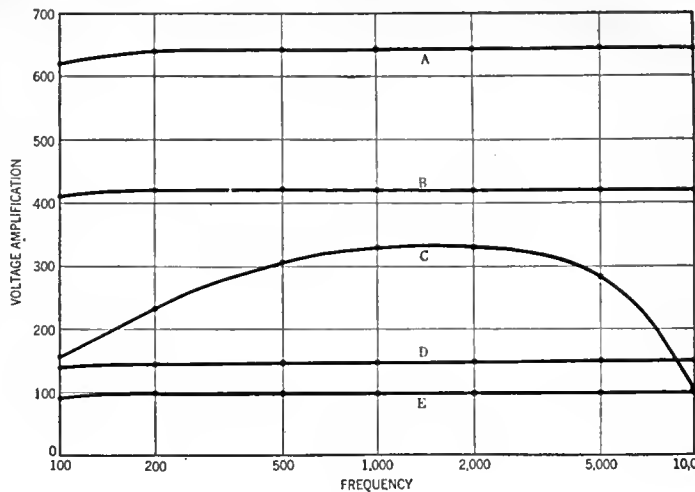

FIG. 10

Curves for various types of audio amplification compared in this article. Curve A. Three stages of impedance-coupled audio amplification, using two Daven MU-20 tubes and one Daven MU-6 in the last stage. One hundred-henry chokes, 1-mfd. condensers and 0.1 meg. grid leaks were used. Curve B. Three stages of resistance-coupled amplification, with two Daven MU-20 tubes and a Daven MU-6 in the last stage. In the plate circuit was 0.1 meg. resistance. The grid leaks were 0.1 meg. and 0.1 mfd. condensers were employed. Curve C. Two stages of transformer-coupled audio amplification were measured. The first transformer was a 6:1 and the second a 2:1 ratio. The tubes used had a voltage amplification of 8 which is standard for the 5-volt type of tube. Curve D. The curve of a three-stage impedance-coupled amplifier using tubes of a voltage amplification of 8; other constants the same as with curve A. Curve E. Three stages of resistance-coupled amplification, with similar constants. Curve B used with tubes whose amplification factor was 8

photographs of the complete set, so that there is little need for lengthy constructional details. However, the builder should be cautioned to keep his grid and plate leads as short as possible and well separated from each other. Most of the radio frequency leads are above the sub-panel, with the exception of the plate lead from the first tube to the primary of the radio-frequency transformer which is long and should be kept well away from all other wires. The lead from the grid of the first tube to the balancing device should

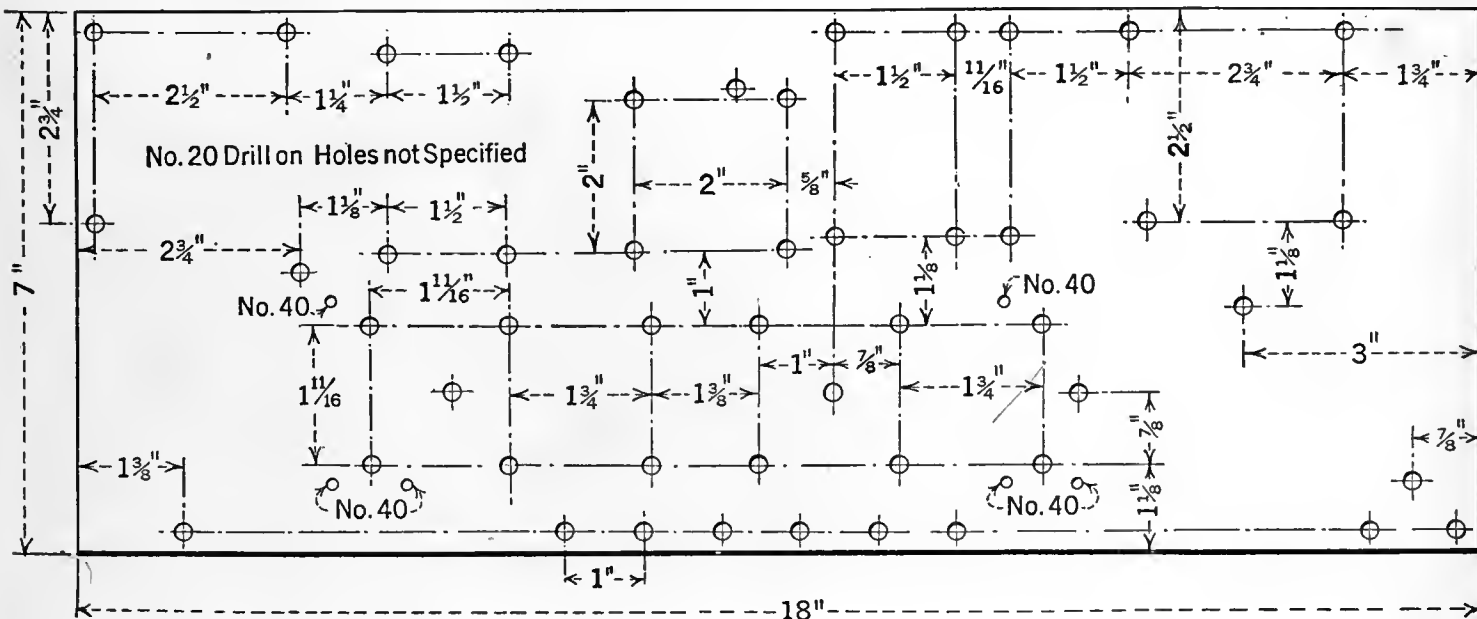

FIG. 9

The sub-panel drilling specifications which are self-explanatory. As you look at this layout the top is the front of the sub-base, and the bottom is the back which supports the binding posts, etc.

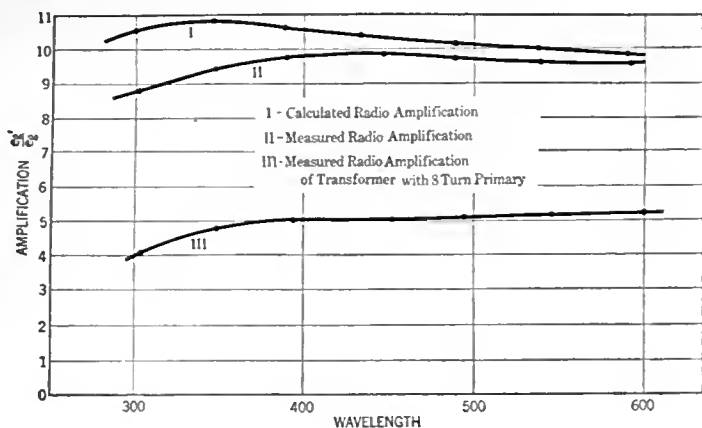

FIG. 11

Three curves which are both interesting and instructive. Note how approximately correct in comparison is the calculated and measured radio frequency amplification while manifestly the 8-turn primary is not as good

also be kept well away from other connections. A center tap is provided on the first coil,  $L_1$ , to be used with a long antenna of 100 feet or over, but as some antennas, which are even much shorter than this, have a large amount of capacity, it is well to make the connection from the .0001 mfd. condenser to the point of the coil which makes the two dial settings most nearly coincide at mid-scale. Only one jack is used, as most radio enthusiasts use a loud speaker except when tuning for extremely distant stations, and then it has been found that three stages of impedance-coupled amplification can be used conveniently with head phones. This is due to the fact that the noise which is apparent with transformer coupling, and which tends to draw comfortable reception of distant

in such a way that greatest signal strength will be obtained

Connect batteries, phones, and ground to the set, but do not connect the antenna. Turn the rotor or tickler coil to a point where placing a finger on the stator plates of the condenser,  $C_2$ , gives a loud "pluck" in the phone. This shows the secondary of the radio-frequency transformer is oscillating. Now rotate the coil until oscillations cease, as determined by the finger test. The first condenser should then be turned through its range, and if, at any setting of this condenser, the secondary of the radio-frequency transformer oscillates, the balancing device should be adjusted until this test is satisfactory, and the two tuning circuits are entirely independent of each other.

stations on the headphones, is absent with the impedance amplifier. Instead of using a filament switch, the jack is made to do double duty, so that placing the plug in the jack lights the tubes.

#### BALANCING AND OPERATING THE RECEIVER

THE first thing to do after the receiver has been constructed as shown, is to balance the first tube so that no radiation will occur, and

A few notes on tuning may be helpful, though actually operating the set is the only way one can acquire the knack of doing DX work. If the set is performing normally, the volume coil,  $L_p$ , can be turned to such a position that placing a finger on the stator plates of the .00025 mfd. condenser gives a "pluck" in the receivers. This means circuit  $L_2, C_2$ , is oscillating. With the volume coil in that position, turn the dial of the .00025 mfd. condenser until this whistle is loudest and adjust the volume coil until the whistle disappears, and by slightly retuning, the station should come in. If the detector tube has a tendency to "snap" into oscillation instead of going in gradually, the resistance of the grid leak should be increased.

The receiver described is capable of extraordinary results, for not only is it a fine distance getter, but quality of the received concerts is almost above reproach. Combined with this is its non-radiating property, and the fact that an extremely short antenna of only ten or twelve feet of wire may be used with satisfaction.

#### Questions Concerning the Receiver Which Are Commonly Asked

- Q. What is the trouble if the receiver tunes broadly?
- A. The .0001 mfd. condenser in series with the antenna may be of incorrect value or an excessive amount of loss would give this effect. The blame might also be laid to poorly soldered connections to the two coils,  $L_1$  and  $L_2$ .
- Q. What makes the detector tube go into oscillation with a "snap" instead of going in gradually?
- A. The grid leak is not the correct size. Try one whose resistance is higher. The grid condenser might be larger than .00025 mfd. (It is much better to use a condenser smaller than .00025 mfd. rather than one larger).
- Q. What length and type of antenna works best with the receiver?
- A. A 50 to 70-foot antenna is usually ample with as much of this vertical as possible. Very good results have been obtained with a piece of wire about 30 feet long extending from a pine tree down vertically to the receiver.
- Q. Will the set work with a loop?
- A. Yes; but even an antenna of fifteen feet located in the same room as the receiver has been found to give better results, and is easier to erect.

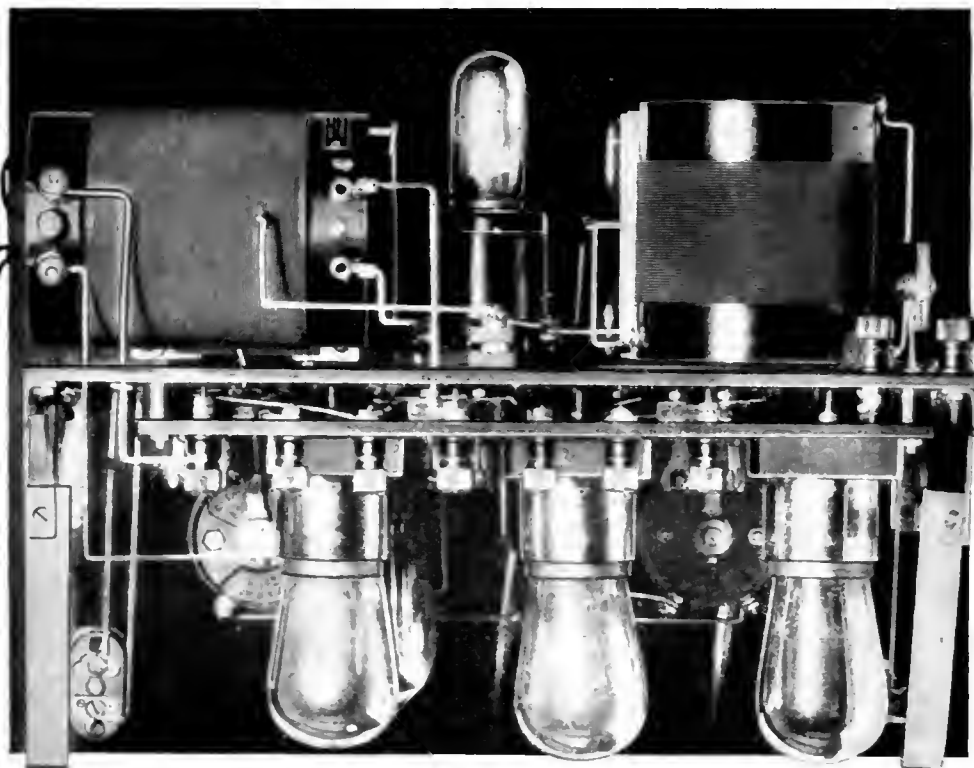

FIG. 12

RADIO BROADCAST Photograph

A compactly built modification of the Browning receiver, which could be made to fit in a phonograph cabinet as described in this magazine for June, July, and August 1925. This one employs resistance-coupled audio amplification. The amplifier units are situated below the sub-panel



# The Listeners' Point of View Conducted by Kingsley Welles

## Is the Popularity of Jazz Music Waning?

**W**HEN radio broadcasting was a novelty and one called in the neighbors to hear the voices coming in "right out of the air," little or no attention was paid to what the voices were saying. "Radio is a marvellous instrument, a tremendously potential medium, but what difference does it make if it is being used to give currency to worse than second-rate stuff," is about the gist of the very vocal objections made by these observers. George Jean Nathan, the rapier-worded dramatic critic of *The American Mercury* said in a recent issue of that green-jacketed organ of dissent:

Nightly the front parlors of the proletariat resound to the strains of alley jazz pounded out by bad hotel orchestras, to lectures on Swedenborgianism by ex-veterinary surgeons, to songs about red hot mammas, and Beale street melancholias by hard-up vaudeville performers.

Now all the criticism of radio programs made along these lines is true in that it is possible to hear the thing described from some radio station or other at one time or another. We should not judge broadcasting by that method any more than we should judge the thinking processes of the American citizenry by what we hear a chance street orator mouth. Broadcasting is not nearly as badly off as its hostile critics would have you think, and the aerial offerings of the radio season now upon us are daily justifying that belief.

"If it weren't for the constant stream of jazz flowing from nearly every broadcasting antenna," remarked a listener to us the other day, "I would enjoy radio a lot more. These jazz orchestras from every station in the country, all practically banging away at the same piece at practically the same time are much more than annoying." The trouble with a criticism such as this is that it groups all dance music as jazz, which is only true because we have no term which allows us to distinguish between the grades of jazz. We use the same term to describe the soft symphonic effects of Art Hickman, Ben Bernie, and Vincent Lopez as we use for the fifth rate Five Melody Kings of Four Corners, Oklahoma.

"I believe," writes D. M. Craig, of Lamar, Missouri, "that the universal condemnation of jazz is contrary to the true feeling of a majority of radio listeners, if all music is classified as jazz. Would these objectors want to stop the broadcasting of such organizations as those of Paul Whitman, Vincent Lopez, Jean Goldkette, and many others?" Decidedly not. While there are those who are utterly opposed to jazz whatever its origin, the more liberal among us recognize that jazz music has a very strong hold on a large percentage of the public of several continents, that it is not wholly as bad as it is pictured, and that, in moderation, jazz is excellent entertainment.

The trouble with broadcasting programs, and up to the past six months this has been true of almost every American station, is that they have been too heavily loaded with this orchestra and that, playing the currently popular tunes. Too much of the program has been devoted to

dance orchestras, or to soloists who had nothing on their repertoire but whatever numbers were being sold in the music shops as "the latest thing" or, worse, to song "pluggers" in the employ of the music publishers. This practise of the broadcasters, we firmly believe, has shortened the life of many moderately good popular numbers, which otherwise might have retained popularity for a considerably longer time.

Mr. Frank McEniry, of station KOA at Denver, in answering a recent inquiry of ours about this subject replied:

On the whole, I believe listeners tire of jazz much more quickly than they do of the classical or semi-classical presentations. This belief is of course, wholly a personal one, but it is based on a daily study of mail from our listeners. Here is an excerpt from the letter of a Western listener which seems typical of a great mass of mail we are receiving on the subject: "One cannot be unmindful of the lovely entertainment last evening; especially beautiful was the Floradora Sextet by the Municipal Band. Likewise, the same selection with the lullaby on the saxophone. I was such a relief from the slap-stick stuff one gets from many stations." That letter was from Charles G. Hickman of Forsyth, Montana.

And here is another from Mrs. Walter Burk of New Plymouth, Idaho: "Almost without exception, we like the better class of music. Jazz ceases to have any appeal after the first two or three selections—it is all alike."

They are doing some good things at KOA, and by the time this magazine is in the hands of the reader, the competitive program of classical music as opposed to jazz music will have been given from that station. All the listeners will have a chance to express their opinion and a complete record will be made of the results. We hope to announce the findings in an early number. There should be some interesting letters after this contest.

Mr. Freeman H. Talbot, that able musician responsible for the programs of KOA set down some of his thoughts about the subject of jazz especially for this department. "For many years," he says, "music critics have been periodically announcing the death of jazz. Probably the



FRANK W. ELLIOTT

The new president of the National Association of Broadcasters, who succeeds Eugene F. McDonald, of Chicago. Mr. Elliott is business manager of station woc at Davenport

so-called music of jazz is largely responsible for the belief that it is moribund. To those who would shed no tears over its demise, jazz displays a most disheartening vitality. Phoenixlike, it arises fresh after each reputed annihilation." Mr. Talbot continues:

Jazz has been called primitive, uncouth, banal. It has been charged with disrupting homes, weakening Church ties, and undermining the morals of the nation. Personally, I feel that jazz is not all bad—it is not clever enough for that. It may be banal, and at times it is discouragingly stupid, but it is not essentially bad. Lately, jazz has gathered to itself some notable defenders among the musically correct. Serious minded musicians have perceived under the battered and tattered appearance of jazz, evidence of a new vitality in music, a struggle after a new form of expression, crude as the hieroglyphics of Cubism, but genuine art, nevertheless.

The moans, shrieks, cat calls and sobs of jazz will eventually disappear, but the vibrancy of its stimulating rhythms will remain to be caught some time by a master composer on a new work or series of works as revolutionary as the cacophonies of Wagner.

How do all these remarks apply to present programs? Well, they are some of the signs—if indeed any are needed—which show that the old preponderance of jazz on programs is greatly lessening. For some time, one of the two outstanding stations in New York City has had a rule, somewhat flexible, it is true, that no dance music can be broadcast until after ten thirty in the evening. Mr. Carl Dreher discusses this matter more fully on another page of this number. The fact that the musical parts of programs are being more devoted to more serious efforts by stations in nearly every part of the country except Chicago, simply means that there is less time left for jazz.

To mention a specific type of program

which has brought improvement in its tone, consider some of the "indirect advertising" programs put on through the WEAf chain of stations. Here is what the director of broadcasting for that station, Mr. J. A. Holman, says about them: "Programs have been presented of a type that previously would have been considered impossible by radio—impossible in the sense that they assumed too high a degree of musical and general culture on the part of the radio audience. The public accepted them at their real value and enthusiastically availed itself of their educational activities. . . . No music was too "highbrow." For example, George Barrère's Little Symphony Orchestra presented a series of chamber music recitals, which while beautiful and perfect gems of instrumental music, are generally considered above the understanding and appreciation of the average music lover. The interesting fact is that the American public welcomed the innovation. . . ." The radio audience is not required to listen altogether to the sad stuff outlined by Mr. Nathan. The signs are unmistakable that

the taste of the radio public is changing, and for the better.

### A New Note in Broadcasting: Coöperation

TO MOST listeners in this country east of the Mississippi River who heard the broadcasting of the radio industries dinner from the Commodore Hotel not so long ago, it probably seemed as if very little was occurring except the presentation of an exceptionally fine purely entertainment program announced by the active Major J. Andrew White. A good program it was, too, with some of the Capitol radio family, the Happiness Boys, the shy Will Rogers, busy explaining why he was not there, Rudy Weidoeft, Vincent Lopez and his Orchestra, and several speakers, including Senator Dill. The radio lambs and lions, however, were lying down together and at executive sessions before and after the dinner, various associated organizations arrived at some decisions whose effect may be far reaching.

The National Association of Broadcasters, whose member-stations include a good proportion of the broadcasters of the country, elected Dr. Frank Elliott of station WOC at Davenport, president, succeeding E. F. McDonald, Jr., of station WJAZ.

And among other applicants, station WEAf, New York, was admitted to membership. This is somewhat important, because thus far, WEAf has played a lone hand in broadcasting. It probably means that broadcasters are going to coöperate to a greater degree than ever before, with inevitable benefit to the listener.

Ever since the first broadcaster was licensed, there has been a quarrel on between the owners of the radio stations and



REINALD WERREN RATH, MME. LOUISE HOMER, TOSCHA SEIDEL, AND A. ATWATER KENT

The Atwater-Kent Manufacturing Company has arranged a series of Sunday evening concerts given at 9:15, Eastern Standard time through WEAf, WCAP, WJAR, WEEI, WCAE, WSAI, WWJ, WOC, WCCO, WGR, WOO, KSD, and WTAG. The series presents some of the best-known artists familiar to concertgoers and is regarded by radio listeners as one of the real treats of the Fall and Winter radio season. There will be thirty concerts and the last will be given some time in May, 1926. Mr. Werrenrath, baritone, gave the first concert on October 4th, and was followed by Mr. Seidel, the well known Russian violinist. Mme Homer, the contralto of the Chicago Civic Opera Company, presented a popular program as the third concert of the series. Mr. Kent is shown in the photograph at the top



JEAN GOLDKETTE AND HIS LITTLE SYMPHONY ORCHESTRA—AT WJR

The photograph at the left shows one of the orchestras heard regularly from station WJR. Left to right: J. Schwatzman, cello; Gaston Brohan, bass; M. Shapiro, violin; Victor Poland, violin; Jean Goldkette, pianist and conductor; Joseph Gorner, violin. The Book-Cadillac Hotel is shown at the right and houses the Detroit studios of WJR-WCX. The transmitting apparatus of the two stations operating on 580 kc. (517 meters) is located at Pontiac, Michigan

the organization which claims to have control of most of the copyrighted musical numbers, both popular and more classical—the American Society of Authors, Composers, and Publishers. This Society to the outsider appears to have what amounts to a monopoly in the control of the performance of copyrighted music. And also to the outsider they seem to have exercised that control in a most arbitrary fashion. Whatever the merits of the disputes between the two opposed parties may be, the situation now seems to be that the broadcasters are unwilling to pay for a yearly license from the Society for the simple reason that they have no assurance that they will be fairly treated from year to year. The broadcasters have taken the sensible position (to use their own phraseology): “we desire to see that the writer of the songs as well as their assignees shall be paid a fair sum. . . . *Resolved*, that the principle involved in the reproduction of music by mechanical means now embodied in the present copyright law be extended to the reproduction of music by radio. . . .”

This means, simply put, that the listeners will benefit, for after the smoke of legal battle clears away, it will undoubtedly be possible for more stations to broadcast much good music which is barred to them now by the provisions of the copyright. It also means that radio is advancing toward a firmer and sounder basis, for there is no doubt that the dispute over payment and copyright has hampered the arrangement and presentation of programs.

### Radio Plums for the Present Season

WHILE the optimistic estimate of Mr. W. E. Harkness of the American Telephone and Telegraph Company that the largest of the WEAf wire tie-ups reached sixty-five per cent. of the listeners of the United States may be viewed with the raising of an slightly doubting eyebrow, it is certainly true that the new concerts of the Atwater Kent Company which began on October fourth have jumped into immediate popularity with a great number of listeners. When the Victor and Brunswick Companies broadcast their concerts last year, the radio audience sat up before its assorted loud speakers and wondered if something new hadn't happened in broadcasting. It had. The tone of all broadcasting was raised and it is our belief that it will never be lowered. The first concert of the Atwater Kent series with Reinald Werrenrath, one of the best of American baritones, set the pace for the rest of the series. Other artists who will be heard in the thirty concerts, which begin at 9:15 P. M. Eastern Standard time, on Sunday evenings, are among the foremost opera and music stars of the world: Louise Homer, Edward Johnson, Mabel Garrison, Maria Kurenko, Salvatore de Stefano, Alexander Brailowsky, Leo Luboshutz, Charles Hackett, Florence Austral, Albert Spalding, Benno Moiseiwitch, Toscha Seidel, Felix Salmond, Vincente Ballester, John Powell, Eva Gauthier, Anna Case, Freida Hempel,

Paul Althouse, Arthur Middleton, May Peterson, Paul Kochanski, Mischa Levitski, and Hulda Lashanska.

Then there are the concerts of the Victor and Brunswick Phonograph Companies which will be heard from the Radio Corporation group of stations, which will present other opera stars. It looks like an embarrassment of riches for the radio audience. Whatever the internal politics among the broadcasters and however strong the grimly competitive spirit, the listener is sure to benefit.

### Learning, Via the Loud Speaker

THOSE who have a burning desire to increase their store of knowledge can accomplish a good part of that end by radio if they are so minded during the radio season now upon us. During the last two years, many radio “extension courses” have been offered over the air, and the State University of Iowa was probably the first higher educational institution to offer a regular air course, which was begun last year. Station WSUI, 620 kc. (484 meters) is broadcasting a course of lectures on Monday and Wednesday from seven thirty to eight fifty P. M., Central Standard time. On Mondays lectures on “Early Iowa History,” “American Literature,” “Iowa Flora” and “Population Problems” On Wednesdays WSUI offers lectures on “The Teaching of English,” “Political Parties in the United States”, and “Elementary Psychology.” Actual university credit is offered to those radio listeners

who complete the requirements of the course. Full information can be secured from Edward H. Lauer, director, extension Division, State University of Iowa, Iowa City. In Pittsburgh, station KDKA will resume its extension courses in cooperation with the University of Pittsburgh and the Pennsylvania State College. In Springfield, WBZ is laying plans for another excellent series of extension lectures. In Oakland, KGO, is broadcasting regularly to the grade schools of the city according to a very well worked out and ambitious plan. Throughout the country, educational programs, most of them well planned out and presented can be regularly heard with little more trouble than a reference to the newspaper programs and the effort of revolving a dial.

### Why the Farmer Likes Radio

VERY early in its experience with radio in the broadcasting of economic information, the Department of Agriculture proceeded on the theory that radio broadcasting, when established as a regular part of the machinery of our present day living, would render a greater measure of service to the farmers than any other group or section of society," writes J. C. Gilbert, the Marketing Specialist of the Department of Agriculture. "The



THE AIR COLLEGE FACULTY AT WSUI

At the State University of Iowa, Iowa City. A series of lecture courses, of college standard are broadcast from WSUI throughout the winter, and college credit is given to those who comply with the requirements. Left to right: Edward B. Reuter, Frank Luther Mott, Bruce E. Mahan, Christian A. Rucknick, Helen Williams, M. F. Carpenter, Kirk H. Porter, Bohumil Shimek, and Edward H. Lauer

Department is firm in its belief that radio is a permanent fixture on the farm, as strongly entrenched, perhaps, as the Ford.

The experts of the Department estimate that there are 553,003 radio sets in use on the farms of this country, as against an estimated total of 364,800 receivers in use in 1924. While most of us depend on radio broadcasting for entertainment and perhaps a bit of news, the farmer is growing to think of his radio set as a source not only of pleasure but of genuine profit.

One of the most interesting letters among a large number written by the farmers to show just what radio is doing for this interested class of listener was written by Fred Buchanan of Granger, Iowa who said:

As early as 8:30 in the morning we get livestock market report and from 10 o'clock on, grain reports. The market reports will revolutionize the farming business. The farmer gets the news about markets right off the bat—he does not have to take the buyer's word for anything, and knows as much about them as the man at the principal market points. . . . If everything in broadcasting is cut out, save the market reports, for they are bread and butter to us out here.

The increasing number of radio sets on farms, suggests the Department of Agriculture, places a responsibility upon those who conduct broadcasting stations and those who have information to distribute. When half a million farmers turn a listening ear toward the broadcasting stations of the country, they expect to hear something worth while. They expect the weather reports, market reports, agricultural lectures, instruction



"WEAF AND TWELVE OTHER STATIONS. . . ."

The "speech input equipment" of the Bell System at 195 Broadway, New York where the program, originating at the WEAF studio is sent to the stations connected to it by wire. On some programs as many as thirteen stations—as far west as Davenport and St. Louis—are connected. At the control board shown, much of the wire "routing" is done. The second panel from the left contains the board on which the program comes from the microphones in the studio. The small hooded lamps are speech amplifier tubes, which increase the strength of the energy before it is sent out by wire to the distant broadcasting station. The three switchboards at the right take the programs for the various wire lines to the Middle West. Two complete "set-ups" are always maintained—one wire for broadcasting, called the red layout, and another, the "order wire," so that instructions can go out independently between the control office and the various stations. If the broadcasting line should go bad, it is possible to swing in the "order wire" and so the program continues without interruption. No other traffic goes out over the broadcasting wires—contrary to regular long distance telephone practise, some lines carrying many other telephone and telegraph messages





LOUIS WILEY

Business Manager of the *New York Times* who recently spoke over WMCA, New York. "The daily newspapers published in English on Manhattan Island," said Mr. Wiley, "exclusive of trade newspapers, have the astounding total daily circulation of 4,039,286 copies. The total is approximately twice the number of families in the entire metropolitan district. There is no other cohesive force, not even our schools, which is so important in the life of our community as the newspaper."

on various subjects from their agricultural colleges and experiment stations. The Kansas State Agricultural College at Manhattan, Kansas, station KSAC, ever since 1923 has taken the lead in broadcasting air courses for rural residents on agriculture, engineering, home economics, and general science. Those who have heard the lectures in these excellent courses will agree that they are well worth an hour's listening.

Broadcast Miscellany

IT IS sometimes fortunate that the radio artists do not hear all the remarks—well intentioned enough for the most part—made by the radio announcers. It was only the other night that a soloist failed to appear at a certain large station. "However," vocally beamed the announcer, "Mr. Edward Gumph, a very dependable artist, will entertain you." Memo for the desk pad: "Be sure to tune-in radio to-night to hear "dependable artist."

THE publicity man of WNYC was doing his best to drum up interest—on paper—about the broadcasting of recent municipal election returns from the station. Quoth he, "The first official election figures available will be heard from this station, since it will operate in conjunction with the Police Department. As votes are counted at the *poles*, each district reports to its Police precinct. . . ." Italics ours, or is it "our'n?" It is so hard to remember

these days when spelling books are out of print.

LEO FITZPATRICK, the "Merry Old Chief" of the Kansas City Star station WDAF has left Kansas City and will now be heard from WJR, Detroit. He was the organizer of the phenomenally popular "Nighthawks" whose membership is said to reach 200,000.

NEXT to WGY, now licensed to use 50,000 watts on Saturday and Sunday nights, KDKA with a license to use as much as 10,000 watts is the most powerful broadcaster in the country. There are ten 5000-watt stations, WSAI, WLW, WOC, WCCO, WCBF, WORD, KOA, WOK, WHO, and WFAF. Stations WGY, and WTAM follow with 3500 watts each, and KFI and KGO each, with 3000 watts are next in power rating. Station WTAS and WJR-WCX use 2500 watts. There are now three stations employing 1500 watts, 25 using 1000, and seven with 750 watts.

THE present conductor of this department is relinquishing his duties with this number of RADIO BROADCAST because of his heavy duties in other departments of the magazine. His successor, Mr. John Wallace, of Chicago, a writer and critic of more than ordinary ability, will continue "The Listeners' Point of View" in the January number.

THE new station, WLWL, 1040 kc. (288.3 meters) operated by the Paulist Fathers, in New York went on the air with its first program not so long ago. A frankly religious station, operated by a branch of the Catholic Church, its first programs have been all that one could ask for in the

matter of dignity and high quality. The work of WLWL is being watched with some interest by listeners in the Eastern part of the country. Those who can hear the station on its high frequency band are missing a rare treat if they do not hear the Paulist Choristers, frequently broadcast from this station, which is on the air between 8 and 10 p. m., Eastern Standard Time, on Sunday, Tuesday, and Friday nights.

A NEW broadcasting station is scheduled for St. Louis which will be sponsored by sixteen firms in that city, the St. Louis *Globe-Democrat*, the Colin B. Kennedy Corporation among them. It will be a 5000-watt installation, located, as is the growing practise, a number of miles outside the city. This is the second large station to be installed by a group of business interests and operated coöperatively by them. The first station of this kind was the excellent WCCO, Minneapolis-St. Paul.

Nashville, Tennessee, has a new station, WSM, which took the air early in October on a frequency of 1060 kc. (282.8 meters).

IT IS reported that *Liberty* has bought the erstwhile WTAS at Elgin, Illinois and will soon come on the air with its own programs. It is to be hoped that the publishers of *Liberty* will be enabled to present programs of a better type than WTAS. The mental level of WTAS is best indicated by their slogan, "Willie, Tommy, Annie, Sammy." The writer defies any one to distill sense out of that. *Liberty* is owned by the same group which publishes the *Chicago Tribune* and the new station, WL1B, will thus join WGN, making two stations in the Chicago area owned by the same interests.



THE COON-SANDERS "NIGHTHAWKS"

Frequently heard from station KYW, playing from the Congress Hotel in Chicago

U.2.G.Y. 76. Salisbury Street, Bedford, England.  
 Ur Sigs were HRD here Sept 19 1925 at 0630. CMT Sigs were DRNR.  
 URM... 3941... 0800... RAC... URN... Reddy... ORM... NG  
 Remarks: W... 111 in R... when Sigs... the... on... 0630...  
 O... 2.G.Y!... Amateur, whose CO I have heard, I beg of U to QSL...  
 OBI pic send me a card. For if U do not... call for U's... 111 call  
 the... of... in my... in... in 192... Up  
 then Guards and Ann... shall I say of... Stubs and Electronics... and by  
 the seven... May they... both QCN, fit for... own ears; May  
 the sky be... with... and the... with... And U Aerial  
 May be... by Guy... May U... and U  
 Amps... May U... and U...  
 May U... and U...  
 and U... And so... all turn out so  
 bad. When this... U...  
 However, if U... I wish U... I raise my hat to U!  
 DX HRD in 1925. Receivers: Remartz with 1 AF 5 Meters to 600  
 375 U.S.A. and Canada. Antennae: 5 Meters 15 vertical wire  
 10 N.Z. & Australia. 10-50 Meters. 12 vertical and 12 vertical U P  
 Chile, Mexico, Cuba. 60 upwires. 42 ft. 50 long  
 South Africa. 50 Countries. VT 730. F CHARAN Int B.C.

Radio 2.G.Y.  
 Ur... Here on... 9.14.1925  
 Audibility R... QSB...  
 Receiver Tubes...  
 1200 A Tubes  
 1200 volts  
 100 volts  
 B... 2.1 amp  
**5HE**  
 50 WATT COUPLED HARTLEY "S" TUBES  
 Just gave "BRUTE FORCE" FILTER  
 HOPE TO QRO OFTEN O.M  
 73  
 300 Kennedy Ave.  
 SAN ANTONIO, TEXAS, U.S.A.

37 SHAWMUT STREET  
 RADIO 2.G.Y. UR... HR.  
 AVD... QSB...  
 TRANSMITTER  
 1-5...  
 30...  
 ANT. AMP...  
 ANTENNA...  
 COUNTER POSE VERTICAL...  
 1135...  
 REMARKS...  
 QSL-OSR ALWAYS

ARRL 718 E. 2nd St. Cushing, Okla. ARRL  
 "Home Of The World's Largest Tank Farm"  
 Radio... SADO  
 Ur...  
 Audibility...  
 Receiver... Cannon Bulls  
 Trans... Amps  
 Antenna...  
 DX...  
 Remarks...  
 Pac QSL Tnx fr ord Cul vy 73Y J. M. Tubbs

# Short Waves—A New

When the Stations Come Rolling In Reception Is Renewed for the Broad paritively Inexpensive—Learning the

By EDGAR

THE twirling dial has captivated the imagination of the world and the prophecy of the Arabian Magic Carpet has been more than fulfilled, as we flit from city to city, by a mere turn of our tuning control. The thrill of dx reception is still with us, but its captivating novelty, strangely enough, is already wearing off.

That the popularity of dx broadcast reception should occupy the center of the stage for so short a period in the interest of the average broadcast listener is surprising, when we consider the marvel of that scientific conquest. But it cannot be denied that those who have tasted a season or two of dx are to-day concentrating in the search for better quality of tone reproduction so that they may receive the local stations with truthful fidelity of re-creation. The dx hound of yesterday is the stickler for high quality of to-day.

Not that we forget those proud moments "when the stations come rolling in," with the aid of a newly built receiver—when New York, Philadelphia, Pittsburg, Cleveland, Chicago, Minneapolis, Atlanta, Hastings, Denver, Los Angeles, Seattle, Oakland, Montreal and Mexico City were heard all in one evening! But even such accomplishments may become commonplace.

To him, who would again enjoy these thrills, we say, take heart, for short wave amateur transmission and reception has brought us new fields to conquer, more fascinating than the old. There is no exhausting the novelty of amateur communication until we have established personal friendships in every corner of the

globe! The construction of a simple but efficient short wave receiver brings the whole world within range of the dial.

When the stations come rolling in on 7500 kc (40 meters), our magic carpet is not delimited in its journeyings to the confines of a mere continent. We begin at the remotest border of our broadcast dx range as the appetizer for an international evening. First, it's England, France, Belgium, Holland, Switzerland, Spain, and Italy. Slowly, we move on as the radio night advances, picking our way through myriads of American amateurs for the foreign stations to which our short wave receiver makes us host. Next, it is Brazil, Argentina, Chile, Alaska, Hawaii, as the shades of radio night advance westward. In the early morning hours, New Zealand, Australia, the Philippine Islands and Japan reward our zealous dial twisting. A diet fit for a dx king!

WHO "BOILED OWLS" ARE

NOR is it unusual, as the first inkling of fleeting time, to have the bright rising sun break into our international reveries and remind us that once more we must resume our daily tasks. For such is the lure of the new dx that its first tastes have led many a new recruit to sit attentive before his receiver the long night through. Such ardent devotees of the dial are rewarded with the honored title of "boiled owl"—a fitting designation for one whose long distance work has been unexpectedly interrupted by the rising sun. Increasing numbers of broadcast listeners are being intrigued into this fascinating field of

radio reception, permitting, as it does, a much greater scope for their dx abilities. The requirements to admission are few. The receiver used is of a much less elaborate type than that needed for good broadcast reception. Two tubes at the most are usually employed. Tuning is so sharp on the high frequency (short wave) amateur bands, that but one tuning circuit is required. Another control adjusts regeneration, which plays an important part in short wave reception. There is nothing startling in the way of special equipment needed.

It is needless to describe in detail a suitable receiver, because extensive experiments are under way, leading to the development of short wave receivers for the needs of new recruits to this new field. Simple receivers and small battery powered transmitters will soon be described in RADIO BROADCAST, and these can be built at costs ranging from \$20 to \$50, including vacuum tubes. These experiments are being conducted at the RADIO BROADCAST

I WAS talking to a chap in Australia last night" is not an uncommon report from a well equipped amateur radio operator in these days of short wave, low power transmitting. The Navy, in 1902 were gleeful over a record of established communication from Annapolis, Maryland to a ship off the coast, 50 miles away. But to-day, even the lowliest amateur would consider a 50-mile transmission as nothing. Of course all this short wave communication is accomplished by radio telegraph and one has to have a working knowledge of the Continental code in order to share the thrills of this long distance work. But learning the code is not



HOW SHORT WAVE HIGH POWER—  
 A section of tape, part of a message received at the Broad Street offices of the Radio Corporation of America from station SAQ at Gothenburg, Sweden. The message reads: "Favor creditbank Oslo 2." The effects of static can be seen in several places appearing as a sharp pointed mark much narrower

S. PORTLAND, MAINE  
0358 6M 7/7 1925  
QRM 100 QRM 100

RECEIVER  
3V FLAME 309 F.H.M.  
30 FLAME 309 F.H.M.  
30 FLAME 309 F.H.M.

OPERATOR RD

ELLWOOD, CITY, PENN.  
416 Glen Avenue  
Radio 2GY U. ew  
WNO R. 255  
8:00 P.M. 86-2 EST  
QRM 100 QRM 100

TRANSMITTER  
at  
Watt Tube in Compled  
Hartley Circuit  
Ray CAC coils on plate  
Rad. J. 255 ICA  
The Old Bean wasn't  
This AM. got up in 2-3  
REMARKS: F.H.M. Haven't done much good since changed  
Aerial Used to get better results with 2-3 writers

8GI

RECEIVER  
1-BGF  
LO LOSS  
One Step AF

Always glad to QSR for QSL  
Every Body on 40 meters OR CRAZY Hard to make Traffic

H. M. ANDERSON, Op

55-1.7.R.U.  
via RESEAU BELGE BELGIUM

TO NARRL T. C. J.  
Muzic de Belgique 38 Ave Labaye 33. Jette Brussels  
YOUR call SIGS RECD. UNIT 04 150Meters 11 7 25  
QRM 100 QRM 100  
RECEIVER USLD 0. V. AERIAL 300 400 200  
TRANSMITTER USLD circuit  
VALVE 1T 1V AMP  
MILLI PLATE CURRENT METERS  
AERIAL CURRENT AMP. W/L  
BEST DX REC. BEST DX TRANS.  
REMARK 3. Have you  
OPERATING b K2  
WITH BEST DX AND CUL 75  
Jan 4th 22 Muzic de Belgique

# Paradise for the DX Fan

on Forty Meters the Thrill of Distance  
cast Listener—The Apparatus Is Com-  
Code Is Necessary But Not Difficult

H. FELIX

1720 UNIVERSITY AVE. SAN DIEGO, CALIF.  
RADIO 26Y UR 40 SIGS RECD. HR. APT. 2  
AUD. 6.00 7 QSB. R.A.C. QSS. 76L QRM

TRANSMITTER  
10 W 2 Tubes  
W. Input  
C. Healy CAL  
ANT AMP .2

6CEV

RECEIVER  
B.T. expanded  
30-150 Meters  
Det. 1 Step  
W.E. Fones

ANTENNA Type Cops Wire 4 FL Long 40 FL High 40  
COUNTER POBLS Fan Type Wire 4 FL Long 30 FL High 10  
D. 6000 Miles QSB States U. 90A C. Dist. N.Z.  
REMARKS: It sure got an awful punch, O.P. has  
so rec'd to gold on 6AWT 735 J. J. Schradler  
PSE QSL-QSR ALWAYS OPERATOR

laboratories with the coöperation of the  
National Carbon Company.

Amateur transmission is carried on  
largely on a frequency of 7496 kc. (40 me-  
ters). Some stations work on about 60,000  
kc. (5 meters) and a great many others on  
3750 kc. (80 meters). Another group,  
employing radio telephony and continuous  
wave telegraphy, work on 1666 kc. (180  
meters). A 7496 kc. (40 meter) receiver,  
however, gives ample opportunity for DX  
work because amateurs in all countries of  
the world where the contagion has spread  
are permitted entrance to the ether on or  
about this frequency.

### WHO'S WHO ON SHORT WAVES

THERE are also other ethereal attrac-  
tions available to the possessor of the  
short wave receiver. Considerable com-  
mercial transoceanic communication is  
carried on by new experimental short wave  
transmitters, which may some day sup-  
plant the immense high power, long wave  
equipments erected prior to the debut of

the short wave. Among these stations are  
Nauen, Germany, POZ, operating on 15,000  
kc. (20 meters); 2YT, Poldhu, England,  
12,000 kc. (25 meters); LPZ, Buenos Ayres,  
8333 kc. (36 meters); 1 XAO, Belfast, Ire-  
land, 4997 kc., (60 meters); SFR, Paris,  
France, 4614 kc. (65 meters); WCM, Rocky  
Point, Long Island, 4000 kc. (75 meters) and  
RDW, Moscow, Russia, 3614 kc., (83 meters.)

Another service, which lends enchant-  
ment to the short wave territory, are  
special rebroadcasting links used to inter-  
connect chains of stations or to furnish  
programs to permanent stations. The pro-  
grams of WGY are broadcast on 8570 kc.  
(35 meters); KFKX, Hastings, Nebraska,  
5357 kc. (56 meters) and KDKA, Pitts-  
burgh, 4838 kc. (62 meters.) Oftentimes  
these programs can be heard with great  
volume on the short wavelengths while  
the broadcast receiver is incapable of  
picking them up on their regular broad-  
casting channel.

The MacMillan expedition also used  
short wave transmission for code and radio  
telephone communication, during its  
recent exploration voyage. Short wave  
enthusiasts were privileged to hear the  
transmitters installed on the two prin-  
cipal ships of the expedition.

The Navy Department has taken cog-  
nizance of the possibilities of the short  
wave in its recent Pacific cruise by the  
installation of short wave station NRRL  
aboard the U. S. S. *Seattle*, flagship of the  
fleet. It selected Mr. F. H. Schnell, Traf-  
fic Manager of the American Radio Relay  
League, to take charge of the transmit-  
ter. The extraordinary success of his  
work is one of the most interesting chap-

ters of amateur short wave history, pro-  
ducing as it did convincing evidence to  
naval officials of the practicability of ex-  
tremely long range transmission on low  
power. The experimental station of this  
magazine, 2GY, communicated with NRRL  
while she was leaving Tahiti in the South  
Pacific Ocean. Forty meters and five  
watts of power were used at the Garden  
City end.

Two difficulties of broadcast dx are not  
encountered to a great degree in short  
wave reception. First, interference is min-  
imized because of the very much sharper  
tuning on the high frequencies (low wave-  
lengths.) Second, the difficulty of identi-  
fying stations is greatly reduced because  
amateurs sign their call letters frequently  
and freely.

### THE CODE: OPEN SESAME

ON THE other hand, the broadcast  
listener must spend some patient even-  
ings in learning the code, for amateur com-  
munication is carried out by the dot and  
dash method. Not that this is a tremen-  
dous undertaking, although the first few  
hours of code education are usually quite  
bewildering. It is something like learning  
to operate a typewriter. If you do not  
know the location of a single letter on the  
keyboard, your progress is very slow. But  
as soon as you are familiar with the position  
of a few letters, progress is quite rapid.

Amateur communication is carried on  
at a much slower rate of sending than that  
used in commercial traffic. By the use of  
abbreviations, representing an efficiency  
comparable only to that of short wave  
transmission itself, the amateur compresses

such a chore as it is commonly reported to be, and  
more than one broadcast listener, to whom DX re-  
ception is almost essential, is buckling down with  
key and buzzer to learn the code and take part in  
the fascinating short wave communication. We  
shall publish articles in later numbers, describing  
the construction of simple transmitters and re-  
ceivers which will operate on these bands. We  
believe with many of our readers who have written  
us since articles about short wave communication  
have appeared in this magazine, that this is a fas-  
cinating new field to which many broadcast listeners  
will gladly come.—THE EDITOR.

### —RADIO MESSAGES ARE RECEIVED

than the characters of the code. The Radio Corporation maintains several short wave stations, some operating on frequencies as high as 15,000 kc. (20 meters), mainly as an adjunct to their long wavelength stations. German and Argentine stations are also using short waves for telegraphic traffic

into a few letters messages of considerable import and significance. A few samples of this esoteric language will serve to indicate the principles upon which it is founded.

*First amateur:*

CQ CQ CQ CQ CQ CQ UIAQR UIAQR  
UIAQR UIAQR . . . . . CQ CQ  
CQ CQ UIAQR UIAQR UIAQR

*Second amateur:*

UIAQR UIAQR UIAQR G2BAO G2BAO  
G2BAO G2BAO QRA?

*First amateur:*

G2BAO G2BAO G2BAO UIAQR UIAQR  
UIAQR QRA WALTHAM MASS GE OM  
U VY QSA HR BUT QRM FM U6CIX  
WL WK U LATER HV 2 MSGS 4 CUL 73  
OM

*Second amateur:*

R R UR SIGS GD BUT QSS CUL

This seemingly cryptic communication is pregnant with information and good manners. CQ is a general invitation to communicate. CQD, the predecessor of the now universally adopted sos distress call, is derived from CQ, the D being added to signify "danger."

UIAQR is the first amateur's official call. The letter prefix designates him as a resident of the United States. The figure 1 indicates his location in the New England district. The United States is divided into nine districts, each headed by a radio inspector. AQR are the letters assigned to this particular amateur by the Department of Commerce.

The acknowledgement of the second amateur consists of the first amateur's call, followed by that of the second amateur's.

The letter G—called in amateur parlance, the intermediate—indicates him to be a resident of the British Isles. The prefix A indicates an Australian amateur; B, Belgian; BZ, Brazilian; C, Canadian; CH, Chilean; D, Danish; I, Italian; J, Japanese; M, Mexican; O, South African; PI, Philippine Islander; R, Argentinian; Y, Uruguayan; and Z, New Zealander. The QRA? means, "Where are you located?"

The answer of the first amateur consists of the usual acknowledgement followed by, "My location is (QRA without question mark) New Britain, Connecticut. Good evening, old man (GE OM). You are very loud here (U VY QSA HR) but I am having interference from U6CIX an American amateur on the Pacific Coast (BUT QRM FM U6CIX) I will work with you later (WL WK U LATER). I have two messages for you (HV 2 MSGS 4 U). I'll see you later (CUL) Best wishes, old man (73 OM)."

The reply means: "I received your message satisfactorily. (RR) Your signals are good (UR SIGS GD) but they fade in and out (QSS). I'll see you later (CUL)."

Eavesdropping on short wavelengths has its fascination but almost invariably, it serves only as an introduction to the creation of a "dyed-in-the-wool ham." The term "ham" is used to describe the owner of an amateur transmitting outfit. Possessed of a transmitter, amateur radio becomes a personal and living thing. It is no longer an external world which you visit as an onlooker. You too can press the key and become a part of the international dot-and-dash whirl.

Those of you who have seen giant trans-

oceanic radio stations, with their immense and stately towers, overshadowing power houses, and buildings filled with transmitting and receiving apparatus, may hesitate to believe that tiny miniatures of these imposing equipments have sent their message half way 'round the world. But the remarkable feature of short wave transmission is the fact that only very minute power is required to set up ether waves which radiate for thousands of miles. Recently an amateur in British Columbia maintained a regular schedule of transmission and reception for fourteen successive nights with a radio-found friend in Australia, using only a five-volt receiving tube, powered by heavy duty B batteries, designed for use with receiving sets! Think of it, you owners of five-tube sets—one receiving tube, efficiently used, is capable of transmitting half way round the world.

SIMPLE APPARATUS IS USED

THE circuits used in these diminutive transmitters are very simple. The all-important thing is the correct arrangement and placement of high grade components. In a characteristic way, RADIO BROADCAST is leading the way to the new field, by collecting data and designing transmitters and receivers for the special benefit of broadcast listeners. As rapidly as the engineers conducting the RADIO BROADCAST-Eveready short wave experiments progress with their work, descriptive articles will be printed in the magazine, giving full details of construction and operation.

Although primarily a sport and hobby, there are serious aspects to amateur transmission. Feelings of sectionalism and nationalism vanish when personal friendships are built up between amateurs in the four corners of the globe. As the boundaries of friendship have been extended through the ages by means of easy communication and transportation, from tribe to community, community to state, and state to nation, we have gradually acquired a unified national consciousness. Tribes no longer fight tribes; rivalries between cities, as that of Carthage and Rome of old, no longer result in bloody warfare, as the telegraph, telephone, railroad and steamship have cemented friendships and demonstrated powerful common interests.

Now we have short wave, low power radio, producing the citizen of the world, with friends whom he calls by name through the radio night, in Melbourne, Paris, Tokio, and Rome! If short wave radio spreads as rapidly as has broadcasting during its first five years, international peace will have a recruit and ally of significant influence. Predictions seem visionary, but we need contemplate only the influence of the telegraph and telephone, which has lifted us out of community interest to a true national consciousness, to lend the color of realism to the hope that the seeds are firmly planted for a new recognition of international bond, established through the agency of short wave radio!



TWO ESSENTIALS FOR AMATEUR TRANSMITTING

The regulations of the Department of Commerce, the Bureau in charge of radio in this country, are that for a transmitting station capable of sending signals outside of the state in which the set is located, a license is necessary. The operator of the station must have a license also. The amateur station license is the long one in the center and the operator's license is shown at the right of that. There is no fee for either license and the examination is not difficult. Licenses are granted to those who can send and receive ten words per minute in the Continental code and who can pass a simple theoretical examination, dealing with the theory and operation of amateur apparatus

# Plans for the Third of the International Radio Broadcast Tests

The First Announcement of the Tests Which This Year Will Take Place in January—Coöperation in All Branches of the Radio Industry Will Make the Third Yearly Test More Successful Than Ever

By ARTHUR H. LYNCH

*Director, International Radio Broadcast Tests*

FOR two years, now, we have, during the early part of the winter, had an opportunity to listen to foreign stations with American broadcasters off the air. Listeners in the far West have heard programs directly from France, England, Spain, and other countries. Our European neighbors have listened to our concerts, and many reports have reached us from South America, Australia and, in fact, almost every nook and corner of the globe.

But every effort which has been made in the past is to be outdone this year. Preparations are now being undertaken to assure some very worth while features on the programs themselves, as well as for the immediate check-up of the origin of certain numbers broadcast, which will make it a simple matter to recognize a station, even when the call letters cannot be understood.

The great difference between this year's tests and those we have formerly conducted, however, lies essentially in the period we have selected. The matter was put to a vote at the Associated Manufacturers of Electrical Supplies Convention at Hot Springs several months ago; at the Radio Manufacturers Association Convention at Atlantic City; the National Radio Trade Association Convention at New York in September; and a referendum was recently taken by mail. In every instance the majority was in favor of the latter part of January, when receiving conditions would be better than at any other time during the year.

Many of the trade associations have already signified their intention of coöperating, and during the annual meeting of the National Radio Trade Association, a fund of several thousand dollars was raised to assist in letting the public know about International Radio Week. Powel Crosley was re-elected Chairman of International Radio Week and L. A. Nixon was

put in charge of the publicity and other matters of a kindred nature.

Among those whose aid has been secured are Mr. F. N. Doubleday, President of Doubleday, Page & Co., who is now in England, where with the assistance of his friend, Rudyard Kipling, he hopes to arrange for the King to address a few words to President Coolidge while millions of us radio-eavesdrop.

Our Canadian friends, under the direction of Jacques Cartier, who is in charge of the week for Canada, are also attempting an exchange of greetings between the King and his Western Dominion representatives.

Radio organizations which for the last two years have been tolerant spectators, are now enthusiastic supporters of the International Test idea and many such groups are taking it upon themselves to see that the entertainment provided for our foreign friends will be of a superior nature.

Nor are we forgetting about the folks at home. Even though the programs are being specially designed for our foreign listeners, they will be of such high quality as to meet the demands of the most sophisticated dial twisters.

The success of the tests this year is made doubly secure, because in Europe and America there are more high-power broadcasters than heretofore, and there will be, by the time the tests are under way, a direct short wave tie-up between our headquarters at Garden City and most of the countries taking part.

From our experience during the last two years, we have learned much and hope to eliminate some of the difficulties by applying what we have learned. One of our greatest troubles was caused by lack of accurate knowledge of what was being broadcast by the foreigners. This year we hope to overcome this bothersome obstacle by having the foreign programs well in advance so as to be able to send them to the press. We are going to arrange to have to-night's program appear in tomorrow morning's paper and in this way make it possible for the listeners in any part of the country to make a check-up for themselves, instead of writing to us, or telephoning us from San Francisco or Houston, to verify a program, as has been the case heretofore.

In the past, many imaginative listeners heard all sorts of things, some of them based on fact. This year we are going to arrange to mislead the misleaders by inserting one or two false numbers in the programs. These numbers will appear in the newspapers, but will not actually be played. Thus, when we get a report from some listener who claims to have heard a number which we know was not broadcast, we will see that his membership in the Ananias Club be entered at once.

For the serious listener, however, who wants to enjoy the thrill of personal contact with many foreign nations within a single short hour, or the scientist who, by properly co-relating data from various

sections of the world, taken during the tests, a golden opportunity will be provided.

Months of preparation will result, this year, we feel certain, in European and other foreign stations being heard in every corner of our country and vice versa. Every listener in America is invited to take part in these tests and assist in making them the greatest we have had thus far.



THE COMMITTEE IN CHARGE OF THE TESTS

Powel Crosley Jr., is at the head of the table; at his left is Arthur H. Lynch; others in the group include L. A. Nixon, second from Mr. Crosley's right, R. W. Demott of *Radio News*, third from Mr. Crosley's left; H. S. Fraire, of RADIO BROADCAST next to Mr. Demott on his left. Mr. George Furness of the National Carbon Company is in the right foreground

# An Improved Plate Current Supply Unit

How to Build a Universal B Battery Substitute Which Is Highly Satisfactory in Operation and Low in Cost—The Parts Are Readily Obtainable—A Description of the New Raytheon Rectifier Tube Which is the Essential Feature of This Device

By ROLAND F. BEERS

SO MUCH has been published in the last six months with regard to B-battery substitutes that the average broadcast listener is in doubt as to what type will give him the most satisfaction. It is natural that certain prevailing types of eliminators will be suited for particular types of receivers, while they are entirely unsuitable for use on others. In order to make an intelligent choice between these various designs, the broadcast listener has had to try out one after another until he has obtained satisfaction. Even after a comparatively thorough test, he may find that the short life of the rectifier elements will cause an expense equal to that of maintaining B batteries.

It is the purpose of this article to describe the theory and construction of a universal B-battery substitute having excellent operating characteristics on all types of receivers, and an unusually long life. The cost of construction will not exceed twenty-

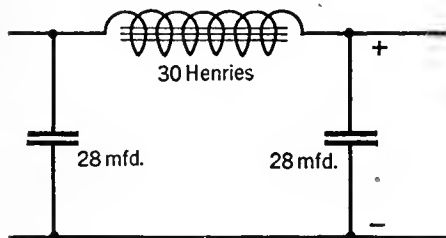

FIG. 1

Two types of filter circuits. That shown in Fig. 1A is the "smoothing" filter popular in 1924 while the circuit, shown directly above, is the "brute force" or reservoir type so highly efficient

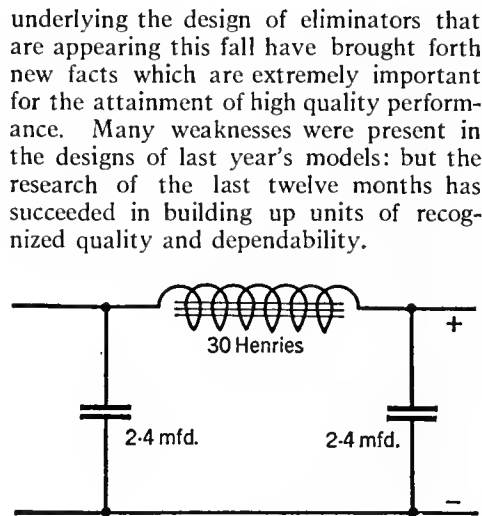

FIG. 1A

In the discussion given below, the reader will find complete instructions and drawings for making a B battery substitute. The general design is similar to that developed by several manufacturers of new B battery substitutes that will be marketed this fall. Complete dimensions, list of materials, size and turns of wire, etc., are given for those who want to make up a complete unit at home. This construction can be very easily accomplished, but for the convenience of those who prefer to use factory-made transformers and choke coils, units are described wherein use is made of these parts manufactured by the Acme Apparatus Company, General Radio Company, Dongan Electric Manufacturing Company, and Jefferson Electric Manufacturing Company. On 60-cycle supply, any of these manufactured parts may be employed with excellent results, and the appearance of the

unit using them will certainly surpass that of the home-made model. The photographs, Figs. 4 and 6, show the construction of models employing factory parts.

## THE RAYTHEON TUBE

THE very heart of this device is the new Raytheon rectifier tube, which has been developed for this specific purpose. The characteristics of this tube are quite revolutionary in their nature.

In the construction of this tube, two anodes are provided, so that the tube rectifies both halves of the alternating current wave. This feature is of first importance because it greatly simplifies the problem of filtering to obtain a pure d.c. supply. An additional feature made possible by the small anode area is that it permits but a minute fraction of the current to flow during the reversed voltage period of the current-flow cycle. Many rectifiers operating on the gaseous conduction principle give forth an extraordinarily high "back current", as it is called, which

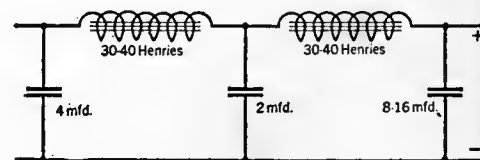

FILTER CIRCUIT COMMON IN NEW MODELS

FIG. 2

A filter circuit common in new models. The intelligent use of chokes and filter condensers here insures smooth output

frequently rises to such a value as to become of great danger to the life of the tube and unnecessarily complicates the filter circuit problem. In the Raytheon tube it is extremely difficult to detect the back current by even the most sensitive measuring instruments.

The Raytheon rectifier has been designed to meet the requirements of most of the standard B-battery substitutes. Its starting voltage is very low—approximately 155-160 volts—and its current carrying capacity is high. The Raytheon tube type B is rated at 60 milliamperes at 150 volts d.c. output. As there is no filament to burn out, the life of the rectifier is extremely long. Standard Raytheon tubes

five dollars, and, as all parts are readily available, the entire unit may be constructed at home. Several advanced features are present in the design described below.

Battery eliminators generally consist of three major elements: A Transformer to convert the 110 volt a.c. supply to the required voltages; a rectifier which converts the a.c. into pulsating d.c. and a filter circuit which smooths out the irregularities of the rectified voltage into a uniform d.c. Most of our readers are already familiar with these elements from previous articles in this magazine. However, the study and development

SINCE our September, 1924, number RADIO BROADCAST has printed the best and almost without exception the only material on chemical and tube-rectified plate supply units. The present article involves nothing startlingly new, but it does describe a new rectifier tube which should have a very wide application and popularity for this type of service. The Raytheon tube, whose use is described here, has no filament. This simplifies the step-up transformer winding, since no extra tap-off from that winding is necessary to supply current for a filament. This unit is also a full-wave rectifier which produces a much smoother potential supply than the other types and simplifies the problem of filtering the output. One of the features of construction of the transformer in this unit is a shield around the primary of the transformer which effectively prevents any stray noises present in the power line from reaching the secondary and being communicated to the rest of the radio circuit. Such a device has never been described before. The problems of construction and assembly are unusually few.

—THE EDITOR.

have been on test at maximum output for more than 4000 hours, and have not yet shown signs of deterioration. It is doubtful if the maximum life of these tubes can be determined at intermittent operating periods such as they would receive in the ordinary operation of a current tap. If they were not abused by overload or continued short-circuit, they should last for years.

The operation of the Raytheon tube in a B-substitute is unusually quiet. The reason for this is that the gaseous discharge is entirely enclosed. There cannot be any sputtering of the discharge which might occur if the elements were exposed to the glass tube or insulators. This act conserves the helium gas with which the tube is filled, and greatly prolongs the tube life.

The operation of a properly designed current tap employing the Raytheon rectifier tube has unusually good characteristics. Some of these will be pointed out in connection with points previously explained. First of all, we have exceptionally good "regulation." The impedance of the Raytheon tube increases with load, causing an upward curve in the load characteristic, in distinction to the usual straight line falling curve that gives low voltage at full load current. The fact that the output voltage does not fall off as rapidly as usual obviates the necessity of providing an excessively high transformer secondary voltage. The lowered a.c. voltage is an important contribution to the safety of operation of the device.

The current and power capacity of the Raytheon tube are sufficient to supply the greater majority of radio receivers. The current output is rated at 60 milliamperes at 150 volts and it has been found from measurements of the plate current consumption of large numbers of receivers that

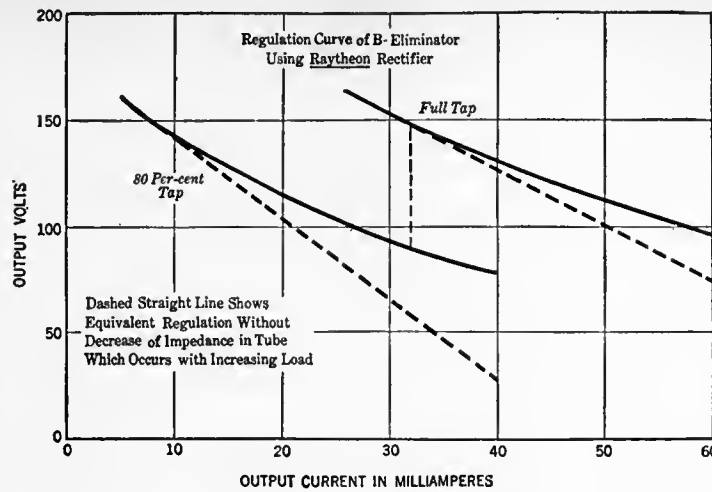

FIG. 3

this value is more than sufficient for the demands of most receivers.

The filtering problem in plate current supply units is usually one of high cost and considerable difficulty. When the Raytheon tube is employed, as it gives rectification of both halves of the a.c. wave, the filtering requirements are much simpler.

Another important feature presented by the Raytheon rectifier is that it requires no power for lighting a filament. This power very often demands a large transformer supply, the cost of which is an item of great importance. With the use of the Raytheon tube, a complete B-substitute can be made up in a space no larger than a heavy duty B-battery.

After a consideration of the foregoing remarks, we may write a set of specifications for the ideal B battery eliminator of to-day:

HOW TO BUILD THE APPARATUS

WE WILL now proceed with the building of the eliminator. Figs. 4 and 6 show the arrangements of the parts when the unit is assembled from factory models. The basis of these models lies in the circuit diagram, a schematic drawing of which is shown in Fig. 7. The values of capacity, inductance, and resistance shown in this diagram have been determined after considerable investigation, and the builder will do well to adhere to these quantities as strictly as possible. These instructions also apply to the construction of the home-made transformer and choke's described below.

Dimensions for the transformer used in this eliminator are shown in Fig. 8. The reader will do well to refer to pages 640-650 of the September RADIO BROADCAST for a general discussion on the proper method of winding and assembling transformers. For the benefit of those who cannot secure copies of this number, a brief discussion of the general procedure will be helpful.

The transformer is made up of three coils of insulated copper wire wound over a core composed of a large number of strips of No. 29 gauge Apollo special electrical steel. These strips are carefully cut by hand from an old power transformer or

LIST OF RAW MATERIALS REQUIRED

6 lbs. Silicon Steel . . . . .	\$ 1.20
28 ozs. No. 31 d.c.c. wire . . . . .	2.19
12 ozs. No. 32 d.c.c. wire . . . . .	.94
7-2-Mfd. Condensers . . . . .	12.25
1-0.5 Mfd. Condensers . . . . .	.90
2-0.1 Mfd. Condensers . . . . .	1.40
1 Bradleyohm No. 10 . . . . .	2.00
1 Raytheon tube . . . . .	6.00
1 Standard socket . . . . .	.25
1-10,000-ohm resistance . . . . .	1.00
	<u>\$28.13</u>

The prices quoted above are maximum retail prices. In some cases substantial reductions can be obtained from the costs given.

Here one tube does the work of two at a great saving in cost, and at a higher efficiency. As indicated previously, there is no back-current perceptible. Back-current is a bad feature from a filtering standpoint, as it complicates the filtering problem, and heats up the choke coil windings often to an injurious degree.

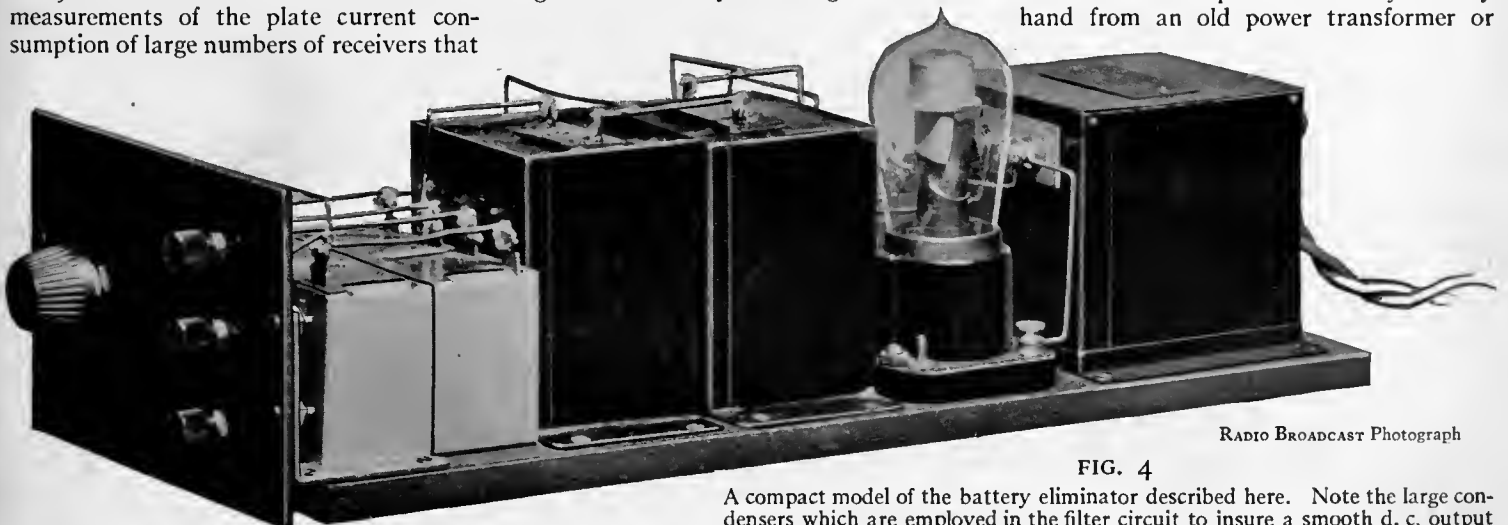

RADIO BROADCAST Photograph

FIG. 4

A compact model of the battery eliminator described here. Note the large condensers which are employed in the filter circuit to insure a smooth d. c. output

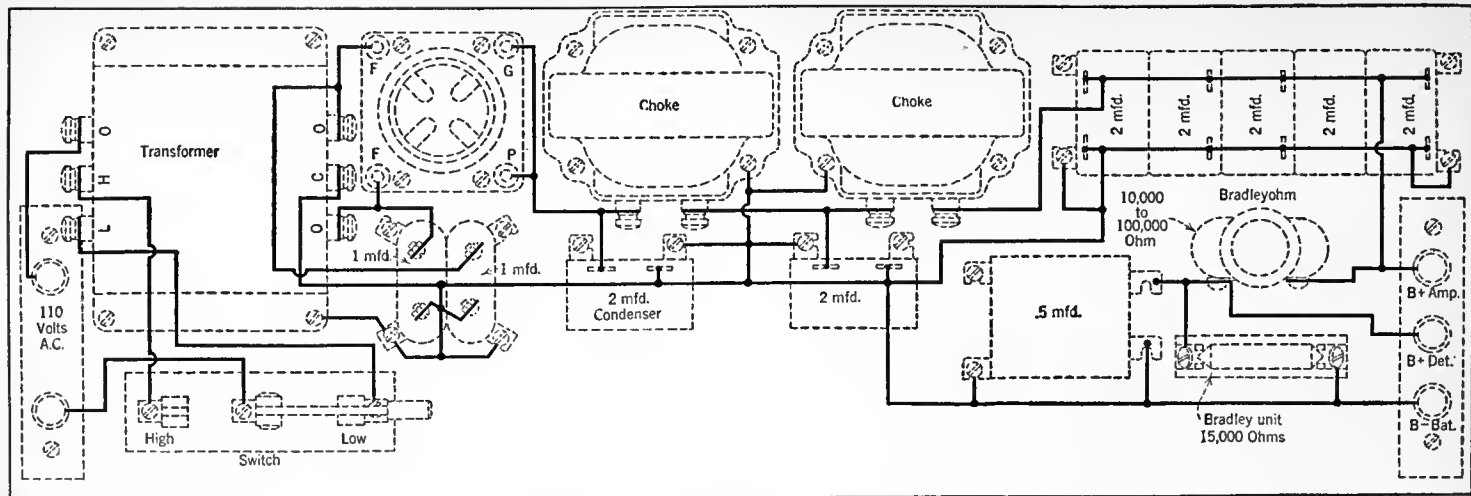

FIG. 5

A picture diagram and wiring layout of the eliminator whose circuit is embodied in the diagram Fig. 7

from sheets of the proper material, and shaped into the forms shown in Fig. 8. Enough pieces are cut out to make up a complete core of the dimensions given in Fig. 8, when they are assembled and clamped together in a vise to determine if the required amount of steel has been prepared. All rough edges must be removed, and the dimensions shown must be uniformly attained.

There are three windings on the transformer which are wound in place on the winding form illustrated in Fig. 9. The winding spool may be assembled on a long stove bolt with nut and clamped in a hand drill, carpenter's brace, or in the chuck of a lathe for convenience in winding the coils. Some means should be provided for counting the turns exactly as they are applied. If the ratio of turns of the hand drill is known for one turn of the handle, it is a very simple matter to use this factor in counting the turns as they are applied. Care should be used to obtain within one per cent. of the specified number of turns on each winding. The primary winding is

applied first over the entire length of the winding form, and consists of 1250 turns of No. 31 enameled copper wire, with a tap taken out and insulated at the 1000th turn. Two layers of Empire cloth are placed over the primary winding, then the two separate secondary windings are wound, each of which consists of 2900 turns of No. 32 enameled copper wire. These two secondary windings are insulated from each other at the middle of the winding form by means of a rectangular separator of .010-inch fiber. This separator is cut out after the primary insulation has been applied, and is put in place by means of a slot cut in one face of the separator. See Fig. 9.

While the first secondary is being wound, the remaining winding space is tightly filled up with a number of strips of cotton muslin or cotton tape, in order to prevent the wire from crowding the winding separator out of place. In all cases, insulated leads 8 inches long, of flexible stranded wire (six No. 30 d.c.c. wires twisted together are satisfactory) are soldered to the

ends of the windings for terminals, before the ends are brought out from the winding. Each terminal is tied in place in order to prevent its being ripped from the coil by accident. If it is necessary, thin strips of paper may be laid over each layer of wire as it is completed, in order to insure smooth layers in the winding. When the coils are completed, the outside is wrapped with two layers of Empire cloth or heavy manila paper as a protection and an insulator.

The steel laminations are now inserted one by one in the completed winding, as shown in Fig. 8 and the transformer is bolted together. If it is not convenient to drill holes in the laminations for the clamping bolts, the builder may cut out clamping plates from hard wood or angle iron. In such case, the bolts will pass through the ends of the core, instead of through the holes therein. Fig. 12 shows the method of clamping adopted by the author in preference to drilling holes in the core. If the builder desires, he may put mounting

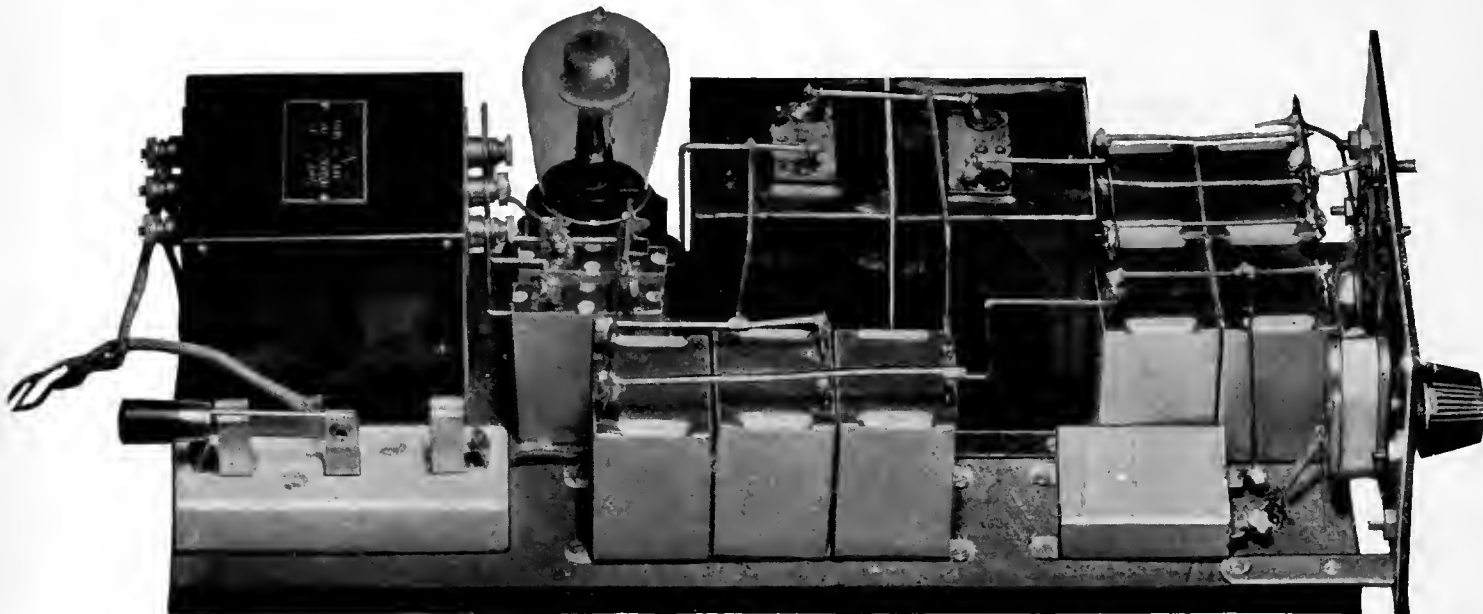

FIG. 6

A different view of the eliminator employing manufactured parts



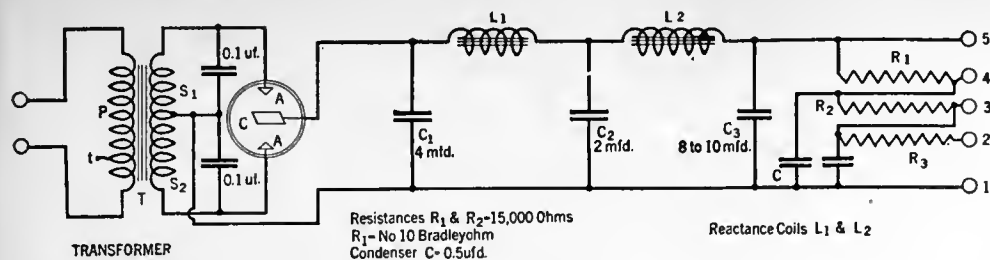

FIG. 7

The circuit diagram of the entire eliminator unit. The transformer at the left steps up the line voltage, passes it to the double-wave tube which rectifies both halves of the cycle. Thence it is passes to the filter where it is smoothed out into pure d. c. The resistances permit the tap-off of the desired voltages necessary to the operation of the receiver

brackets on the base of the transformer to aid in securing the instrument to the base board.

NEXT, THE CHOKE COILS

THE choke coils, shown at  $L_1$  and  $L_2$ , Fig. 7 are constructed in a manner similar to that employed in the making of the transformer. Each of these coils will have an inductance of approximately 20 henries if care is taken in constructing and assembling the cores. All rough edges should be removed and the cores should be assembled in an orderly manner.

The winding on each choke coil consists of 5000 turns of No. 31 enameled copper wire, wound in smooth layers with the necessary interleaving papers. The outside of the completed coil is wrapped with one layer of heavy manila paper as a protection. The laminations shown in Fig. 10 are inserted in the completed windings, and the entire coil is assembled in accordance with the description of the power transformer above. A piece of .005-inch paper is inserted in the air gaps of the choke coil cores, to insure the magnetic stability neces-

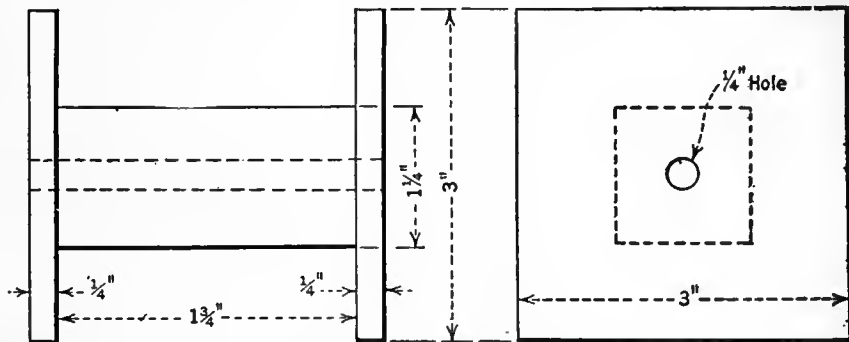

WINDING FORM FOR TRANSFORMER COILS

FIG. 9

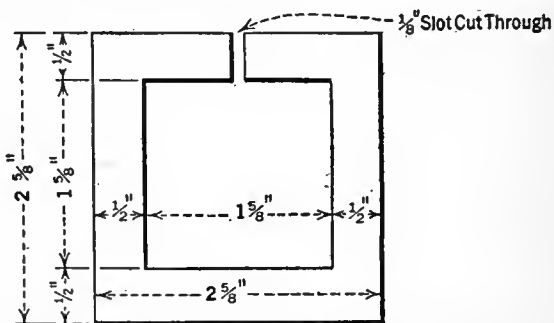

WINDING SEPARATOR FOR SECONDARY WINDINGS-1/8" FIBRE

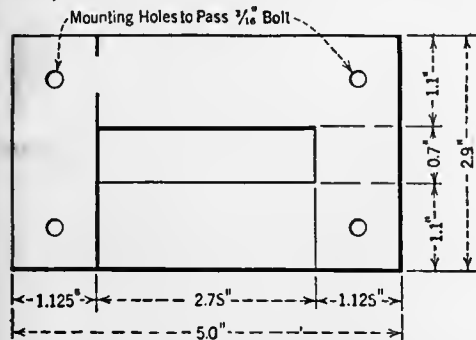

ASSEMBLED TRANSFORMER CORE

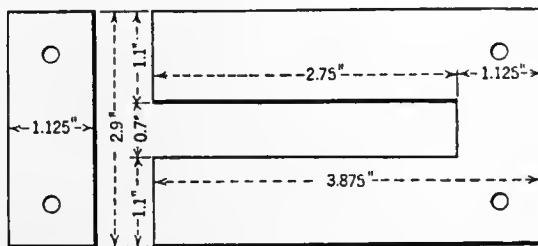

LAMINATIONS FOR TRANSFORMER CORE

Material: No.29 Gauge Apollo Special Electrical Steel.  
Required: Approx. 80- Pieces of each Type  
Total Core Weight: Approx. 3 Lbs.

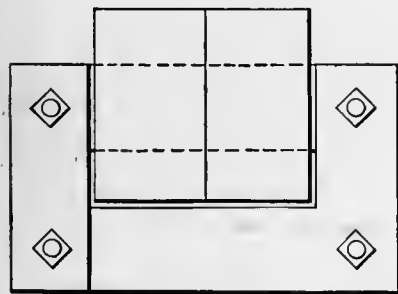

ASSEMBLED TRANSFORMER WITH WINDINGS IN PLACE

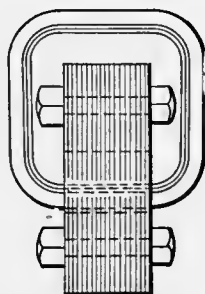

Transformer Coil  
Primary Winding 1250 Turns No.31 Enamel  
2-Secondary Windings each 2,750 Turns No.32 Enamel  
.005" Copper Shield between Primary and Secondary

FIG. 8

Transformer core details

sary under the operating conditions. When this has been accomplished, the clamping plates are secured as described above.

The filter condensers, shown in Figs. 4 and 6 were procured from Tobe Deutschmann, Cornhill, Boston, Massachusetts, and have passed the most severe operating conditions. They were subjected to repeated charging and discharging at 700 volts d.c., and

withstood the strain upon the dielectric successfully. None of the samples examined in this way were found to break down. The equivalent series resistance was found to be low enough to give excellent results in connection with the B battery filter circuit. The particular arrangement of the filter circuit shown in Fig. 7 requires a total capacity of 14 mfd. and the distribution of this quantity is more important than the absolute value. If this circuit does not meet with the requirements of the attached receiver and loud speaker, a slight improvement will be effected by increasing the value of  $C_3$  to 12 or 16 mfd. Increasing this capacity beyond 20 mfd. does not add greatly to the standard of quality already established and, for average conditions, this capacity need not exceed 8 mfd.

The arrangement of the detector voltage control shown in Fig. 7 is unique in some respects, and is an improvement over the usual series resistance method. A 0.5 mfd. condenser is used to by-pass any disturbance that might reach the detector through other paths. The amplifier volt-

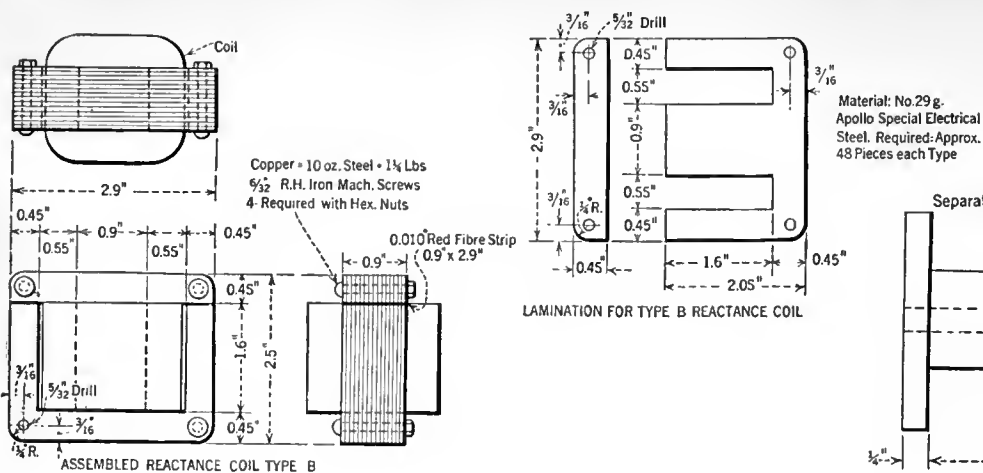

**FIG. 10**  
Here are given all the specifications necessary for the construction and assembly of the choke coil cores

Material: No 29 g. Apollo Special Electrical Steel. Required: Approx. 48 Pieces each Type

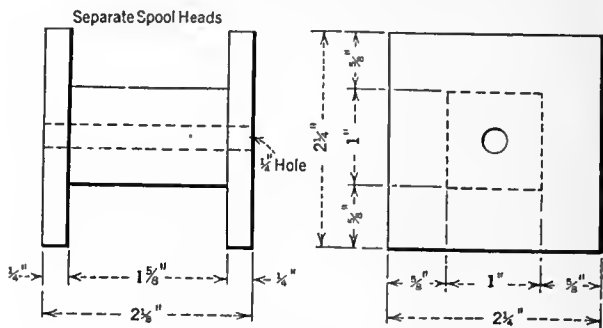

Material: Wood Winding: 5,000 Turns No.31 Enamel Copper Wire

**FIG. 11**

age is controlled by means of the switch shown at S, Fig. 7. The blade of this single pole, double throw switch is connected to one side of the 110 volt a.c. line; one lug goes to the 1000th turn tap on the primary, the other lug goes to the full secondary terminal at 1250 turns. When the switch is thrown to the 1000-turn tap, the output voltage will be from 30 to 50 volts higher than on the 1250 tap, depending upon the connected load.

The Raytheon rectifier tube will ordinarily run at a temperature in the neighborhood of 200 degrees F. In case the cup should become red hot, there is evidence that the circuit is being overloaded. Although no permanent damage will be done, it is not advisable to continue this load for more than a few minutes. Continued overloading will soon saturate the cores of the choke coils and render them useless as filter chokes.

In order to prevent the transmission of power line noises through the eliminator circuit, a copper shield has been placed between the primary and secondary windings, and thoroughly insulated therefrom. This consists of a strip of .005-inch copper carefully wrapped over the Empire cloth insulation, and extending within 1/4 inch of the entire periphery of the primary winding. A flexible lead is soldered to the shield, brought out from the winding, and later connected to the ground terminal of the eliminator. All cores of the instrument should be connected together and to the ground terminal. The homemade unit should be placed in an iron or steel case which completely encloses the unit. In the case of the factory units, each part has been placed in an iron magnetic shield, and this is connected to ground to prevent induction of hum in the receiver. Another means for preventing the transmission of line noises through the eliminator is the use of the buffer condensers, shown shunted across the mid-tap and outer leads of the secondary of the transformer, Fig. 7. These

*Specifications for the Design of Ideal B Battery Substitute*

**I. TRANSFORMER**

1. Power loss should not exceed 10 watts.
2. Should operate on 25 to 75 cycles a.c.
3. Secondary voltage should not exceed 300 volts for safety.
4. Should be shielded in magnetic shield.
5. Should have electrostatic shield between primary and secondary windings to prevent transmission of line noises to radio receiver. Secondary winding should be balanced for inductance and capacity.

**II. RECTIFIER**

1. Should have life of at least 5000 hours.
2. " deliver sufficient current at all times.
3. " have low impedance, preferably rising characteristic. (See Fig. 3).
4. Should rectify completely with no reverse current, and with quiet performance at all times.
5. Should rectify both waves of cycle.
6. Should have low starting voltage—i.e. not greater than 160 volts.

**III. FILTER CIRCUIT**

1. Should filter perfectly, leaving no hum in headphones.
2. D.c. resistance should not exceed 750 ohms.
3. Should consist of two or more sections instead of one section.

**IV. MISCELLANEOUS**

1. Should give complete control of amplifier and detector voltages.
2. Should be small and light in weight.
3. Should be capable of being installed in receivers without producing interference.
4. Cost of construction and maintenance should be low.

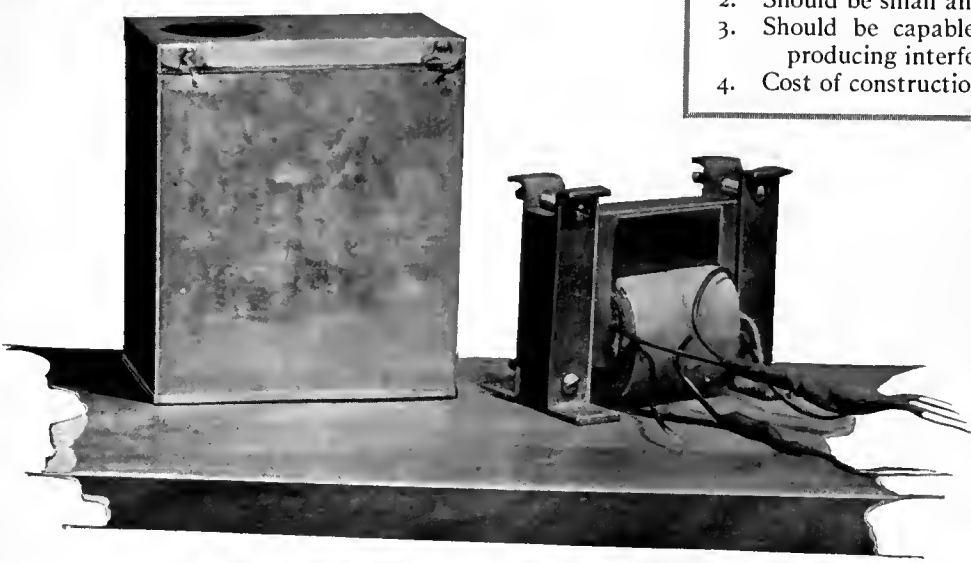

each have a capacity of 0.1 mfd. and serve the purpose of balancing the admittance of each secondary to the neutral or ground side of the line. There is in this way an easy path to ground provided for any disturbing unbalance that might arise in any part of the circuit. The inclusion of these condensers is an important feature, and one that will more than repay their cost.

**FIG. 12**  
A made-up transformer with its tin-can shield

# AS THE BROADCASTER SEES IT

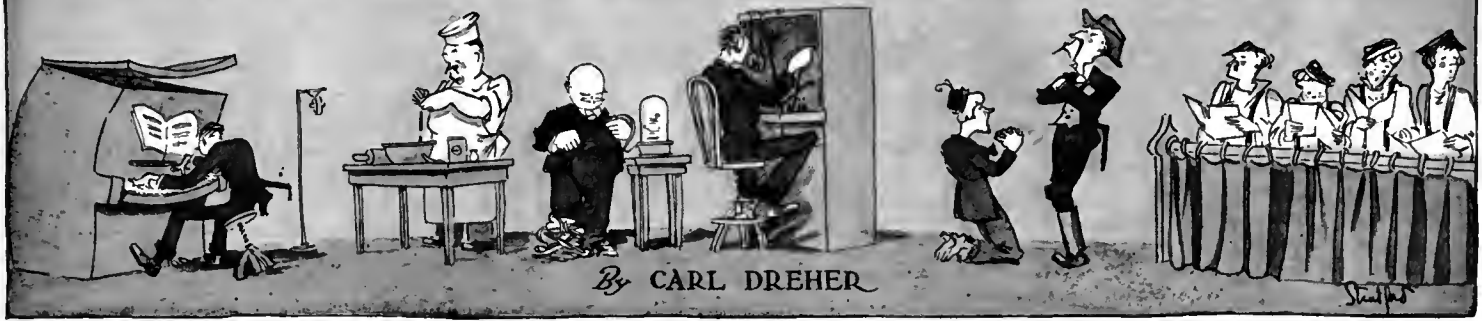

Drawings by Franklyn F. Stratford

## In Defense of Broadcasting

**I**N THE September issue of the *American Mercury*, under the rubric of his monthly department, "The Theatre," Mr. George Jean Nathan pays his respects to broadcasting in terms which will descend harshly on the ears of radio impresarios who were beginning to believe what their own publicity representatives write about them.

Supporting the cheap magazines and moving pictures in their campaign to moronize the country, writes Mr. Nathan, we now have the radio. The roofs of houses from the Atlantic to the Pacific presently take on the aspect of so many sailless schooners. And nightly the front parlors of the proletariat resound to the strains of alley jazz pounded out by bad hotel orchestras, to lectures on Swedenborgianism by ex-veterinary surgeons, to songs about red hot mammas and Beale Street melancholias by hard-up vaudeville performers and to the names of the notables who have just come into Reuben's delicatessen restaurant. Where a few years ago, a family living in the hinterland occasionally after dinner read a book or at least looked through an album of "Famous Masterpieces of Painting," it presently glues receivers to its ears and is thrown into wild aesthetic transports by some Harlem coon's *recitativo* on his *Heimweh* for Alabama or some two-a-day De Pachmann's interpretation of Mozart on a saw. There are two radio broadcasting stations, one in New York and one in Philadelphia, that have made an effort periodically to give their customers something better in the way of music than that which, for its finest effect, must be played on kitchen utensils and cowbells and something better in the way of educational talks than lectures on hygiene by press agents for new mouth-washes, but I understand that they have found the going rough and, in self-preservation, have been forced to fall back more and more on the gibberish and caterwauling that the aerial connoisseurs admire.

Readers who have never before encountered Mr. Nathan's mode of expression will observe that he does not deal in weasel words. He makes it plain that no high-pressure salesman is going to sell him a \$575. radio set. Not that Mr. Nathan has anything against broadcasting in particular. In the article from which I have quoted he rends and tramples on the twenty cent magazines, the movies, tabloid newspapers, and other such agencies of popular

enlightenment. If you were the editor of a tabloid newspaper, how would you like this projectile: "A tabloid newspaper, you need not be told, is a newspaper reduced in size, sense, taste, and decency." Mr. Nathan lets radio off easy, comparatively speaking.

Many broadcasters, unused to criticism along old fashioned football lines, will roar indignantly and let it go at that. That attitude possesses neither maturity nor good sense. If the critic has no case, what he says will in time dissipate itself, like gasoline vapor on a boulevard, and there is no need to get het up about it. If what he says is true, wholly or partially, we might as well let him rub our noses in it and then see what we can do about it. And then, criticism is advertising, and no one can tell me that broadcasters don't like advertising. In this they are

like George Moore, who used to say, according to Frank Harris: "Attack me as you please; slang me, but write about me. I'd rather have a libelous article than silence; indeed, I think slander more effective than eulogy. If you hate my books, say so, please, at length; that will get me readers."

As for me, I can discuss this subject in a serene and unprejudiced spirit. While I am a professional broadcaster and derive most of my income from radio, my responsibilities are purely technical. I am an engineer and I put out on the air what is given to me, just as a telephone installation man wires up equipment indiscriminately for crooks, philanthropists, theatrical ladies who drive Minerva cars on an apparent income of \$35. per week, and gentlemen of the cloth. The gentle rain falls alike on the just and the unjust, and I don't care what I broadcast. It's no skin off my back if the programs are rotten. As long as the transmission is good, I get my check and the V.P. & G. M. smiles on me. So much for the benefit of those spectators who might imagine that I am moved in my defense of broadcasting—to the extent that I feel called on to defend it—by my need for Hungarian goulash and French pastry.

Mr. Nathan's indictment is true enough, alas, but it should be added that he has selected the holes in the cheese for his discussion. There is considerable nourishment in the solid portions. Among some 600 broadcasting stations in operation in the United States, at any given time, some will be radiating respectable stuff, others will be carrying a load of aspiring sopranos and so-so material, still others will be engaged in purveying aerial garbage for the listeners who like that sort of thing. A cross-sectional view of the burden of the ether waves would show as great a variety in quality as the same process applied to periodical publishing, say. If one walked blindfolded up to the newsstand at the corner of Sixth Avenue and Forty-Second Street in New York, picked out a magazine, opened it at random, and analyzed the pages exposed for ideas, the percentage revealed would probably run even with the birth rate among mules. And that newsstand, be it noted, carries all the respectable magazines



WHEN IN DOUBT, THEY WIELD THE BLUE PENCIL

as well as the cash girl trade; at most magazine stores the chances of lighting on something in the cultural Class A would be even less. If you are after intellect and good taste, you must pick it out from amid the rubbish. Likewise in radio. If you want jazz issuing from your loud speaker, there are certain wavelengths in every radio locality where you can get it at any time. If you want something better, you may be able to get it if you have learned to discriminate between stations. You may not be able to get it just when you want it. But there is just as wide a range between the best and the worst broadcasters as that between the most estimable and the most trashy books or magazines. And, owing to the vast and, perhaps, excessive amount of broadcasting, there is also a great variation with respect to time in the case of any given station. In order to arrive at a fair judgment, one would have to assess a lot of broadcast material and to do far more listening than Mr. Nathan has either the time or the inclination for, in all probability. As one of his customers in his present vocation, I should lament his engaging in any such Augean task. But I, perforce, have done something of the sort. In the last two and one half years, equipped, gratis, with a very fine receiving set, I have put in some 3000 hours listening to my own stations and others. Some of the stuff was not fit to inflict on an ursine howler. Most of it, culturally, was neither here nor there, like the columns of a newspaper or the counters of a five-and-ten-cent store, it had nothing to do with learning the arts, or civilized taste. It neither assisted nor came into conflict with these things. Some of it, the cream, required no apologies to any one. For three summers, now, any one who cared to tune to 600 kc. (455 meters) could hear the New York Philharmonic on the air two or three nights a week, absolutely "without concessions", as the management puts it, to the popular taste for operatic selections, easy overtures, and the like. Having thus thoroughly sampled the ethereal waves, and emerged sound and articulate, I depose and say that the average metropolitan broadcasting performance is no more offensive to

good taste than the average printed book or magazine, not half as disturbing to the same as the average city newspaper, and not one quarter as flagrant as the average big time vaudeville show or moving picture. As for the tabloid newspapers and other such dung-hill enterprises, broadcasting, with all its glaring faults, is positively a civilizing influence; by contrast, its entrepreneurs and managers become so many Schopenhauers, and Sidney Laniers.

It is true that a great many silly and obvious talks get a hearing *via* radio, and that not a few of the lectures have an unpleasantly sanctimonious and oily tone. The second fault is caused partly by the influx of people quite without qualifications for radio lecturing, who try to compensate for their deficiencies by slobbering over the listeners. On the other hand, one hears more than a few people on the air whose natural frankness and sincerity manages to get through to the orifices of the loudspeakers. Dr. John H. Finley is one such engaging speaker; even if one does not agree with what he says it is pleasant to listen to him. As for the content of the talks, it varies all over the map. I have heard everything from an inspirational speaker (he broadcast in a frock coat, incidentally) declaring, "All the evils of the world are due to incorrect thinking," to a lecture on Whitman by such a recognized authority as Prof. Emory Holloway, the reading of a story by Sherwood Anderson, and performances of one act Provincetown plays.

The trouble with radio talks is mainly that the owners and program managers of the stations feel it incumbent on them not to offend *anyone*. They are in a constant stew about "adverse publicity." A few letters from irate listeners give them the horrors. They run their stations for advertising or good will, and as soon as any one looks at them cross-eyed their knees shake. When in doubt, they wield the blue pencil, and any one who tries to please the whole world is in doubt most of the time. In such large audiences as those they figure they are catering to, there are thousands of inferiority complexes ready to be triggered off. Eddie Cantor once delivered a first-rate humorous talk

over the radio, and at one point he remarked extemporaneously, "For all I know a lot of Polacks are listening to me." The comedian, of course, had no offensive intention, but during the next few days he received twenty protests from Polish listeners, including a formal denunciation from a society. If I wrote a story containing some reference to an elderly Jew in a green sport suit, and there was nothing else the matter with it, there would be no difficulty in getting it published and receiving payment for it. But broadcasting that phrase, at the present stage, would be out of the question. No program manager would touch it. In his audience of several hundred thousand there must be several elderly Jewish gentlemen who wear green sport suits, and he wouldn't make them sore for the world. No one must be offended, no one's morals must be impaired, a thousand dignities must be tenderly preserved, the lecture must be fit for everyone between the ages of eight and eighty. If, under these conditions, the content of the talk is also to be mature and significant, you have a large order.

Even controversy is often frowned upon. Admiral William Ledyard Rodgers and General Tasker Howard Bliss recently broadcast a debate on "Shall America Arm for War?" under the auspices of the *Forum*. The debators did not come to blows, no riots were reported, and the more thoughtful among the listeners spent a profitable half-hour. The magazine next wanted to put on the air a debate between Professor Osborn and Mr. Bryan on the subject of Evolution. But this was declared to be "too controversial" by all the station managers interviewed. So it was not broadcast.

Mr. Nathan's conclusion that jazz is the staple radio musical diet does not jibe with my observations. There is a great deal of jazz on the air, and a few stations emit almost nothing else, but they are decidedly atypical. The average musical radio offering is rather something on the order of the Silvestri-Toselli "Rimpianto" serenade—pretty and obvious. In short, the sort of thing all dining room orchestras in big hotels turn out. Some of the hotel "ensembles" are very good, incidentally. They broadcast popular classics. If I have heard "Mon cœur s'ouvre a ta voix" once, I have heard it a hundred times. There is a lot of Old Black Joe-ing and Silver Threads Among the Gold on the air, but, after all, these are decent folk songs, objectionable only when overdone. Down another peg are college things like "Rolling Down to Rio," and the bombastic "Invictus." Not over a third of the total is jazz, and on top you have beautiful *Lieder*, the best symphonies, including all the Brahms, the tone poems (I have heard *Don Juan* on the air in its entirety seven times) and the Strauss waltzes. At one station in New York, for example, absolutely no dance music is allowed on the air until after 10.30 in the evening. All in all, not so bad.

Such inventions as the motion picture and the radio telephone have cultural and artistic possibilities, which are rarely realized because, with a large initial investment and heavy operating expenses, the only way to get a return on the money is to produce something attractive to the masses. The result is what we know. Only two copies of Thomas Hardy were sold in Boston in the six months from January 1 to July 1, Mr. Nathan points out. Still, the movies could do something even for Hardy's art. Needless to say, I don't mean any such shameful burlesque as the movie version of *Tess of the d'Urbervilles* which appeared a while ago. But if I had a few million-dollars, I'd make a moving picture of Hardy's *The Dynasts* and perform it, serial fashion, a competent actor, to be



RADIO IS TRYING TO PLEASE ALL BETWEEN EIGHT AND EIGHTY

selected by Mr. Nathan, intoning the lines, to the accompaniment of a first class symphony orchestra. I should do this, not to improve the movies, which can go straight into the sewer for all I care, but purely for the benefit of the few who care for that sort of thing. The Napoleonic wars forming the background of Hardy's great epic, the transparent tentacles of the Immanent Will, moving irresistibly those great columns of soldiers wearing the expression of men in a dream, could only be portrayed in the medium of the cinema.

Similarly, some day, somewhere, a millionaire with *American Mercury* tastes may endow a radio broadcasting station to disseminate material which is agreeable to him. If so, I shall be pleased to oil the generators for same, and to be counted among its listeners. Mr. Nathan might buy an eight-tube "super" on that remote to-morrow. In the meantime, radio is neither as good as the publicity artists would have us believe, nor as bad as Mr. Nathan has painted it.

### Technical Routine in Broadcasting Stations

#### 1. Wire Lines

LAST month, in our discussion of "Personnel and Organization in Broadcasting," we took up in some detail the responsibilities and functions of the various employees, program and technical. However, the bulk of the discussion was on the problem of securing programs, rather than broadcasting them. In this issue we shall get down to the actual business of putting the program material out on the air, with all the technical preliminaries involved.

The technical staff, as we have seen, is divided into transmitter, control, and field divisions, all reporting to an engineer-in-charge or chief technician of some sort. These men work with the announcers and the studio manager during the actual broadcasting. First, however, we shall take up the technical routine which precedes it.

This technical routine, in many respects, is not radio at all. For example, the testing of wire lines is no more characteristic of broadcasting than of wire telephony, but it is equally important in both. Practically every large broadcasting station finds it necessary to go after its programs by means of telephone lines. These lines are in a few cases owned outright by the broadcasting company, but as a rule they are leased from some pre-existing telephone or telegraph company. Lines are costly and one does not generally buy them outright, any more than one buys a railroad in order to commute. When the lines are leased from some public service corporation, they are usually maintained by the owners. Such a system will consist of certain trunks running through the principal part of the town, possibly in the form of a ten-pair cable devoted exclusively to radio, for it is important that these wires should not be subject to inductive disturbances and that they should not interfere, in turn, with other public services.

A week or more before the time scheduled for broadcasting, the program department sends a list of projected field events to the line company. On a certain day, for example, a musical comedy is to be broadcast from a theatre. The

wire company then runs a twisted pair from a convenient terminal box on the nearest trunk, over housetops and streets, to the theatre in question. This lead is called a "lateral." If the broadcasting company is leasing an adequate wire system these laterals are normally only a few blocks long. The expense of work and material is charged to the broadcasting company, so it is wise for the latter to balance trunk costs against additional construction in order to get a minimum total for the two. When the wire is placed in the theatre, with a long lead left in a coil so that the broadcasting operators can set up at a convenient point in the house, the telephone or wire company's lineman calls up the station, using an ordinary portable telephone, and tests through. He rings the station with a magneto, causing a telephone relay to release a drop on the station switch board, and says to the control operator who answers, "This is—at the Criterion Theatre. Will you test this loop?" The operator then puts 110 volts on each side of the line through a voltmeter to ground. If the loop is properly insulated the meter will read only a few volts, the resistance in series with it being of the order of many megohms. The ends of the pair are then short-circuited at the theatre and a continuity test is made to locate high resistance joints and the like. If the line is in good shape, the meter will read practically full voltage, the line resistance being negligible compared to the resistance of the voltmeter. So far we have merely the standard procedure which thousands of wire chiefs go through every day on telephone and telegraph lines. However, a further test is now made in which radio standards are rather more critical than those of the older services. The men on the line listen for noise. If they can hear any noise at all with an ordinary pair of telephones bridged across the line, they are apt to run into trouble during quiet intervals in the broadcasting.

Noise comes in from various sources, such as stock-tickers, parallel Morse circuits, elevator motors, etc. Each of these machines has a characteristic sound, and men who work on lines become familiar with the various types. Usually noise interference is due to some unbalance of the line. It is necessary to have the circuit accurately symmetrical, electrically, about an imaginary reference line in the middle. Fig. 1 shows this condition, the line terminating at either end in repeating coils, or 1:1 transformers, with grounded midpoints. Each side is assumed to measure 60 megohms to ground. If, now, one side of the line should be opened

or grounded, a roar of noise would probably come in, although in the balanced condition the circuit might be perfectly quiet. But it is not sufficient to have the two sides of the line equal in insulation resistance. It is also necessary to transpose or interchange the two wires frequently, so that induction picked up in one stretch is neutralized in the next stretch of equal length. On an open wire line running on cross-arms fastened to poles, each pair of wires will be transposed at, say, every tenth pole. Likewise, in a cable, the various wires must be "paired." "Twisted pair" is used, never simply a pair of wires lying side by side. In a properly paired cable several miles long, a few hundred feet of "straight-laid" conductor will ruin the entire circuit for broadcasting purposes, because of the excessive noise picked up. The telephone engineers put it this way: "A telephone circuit balanced in all respects, including balance to other circuits, is immune to inductive interference."

When trouble is encountered on wire circuits, it is hunted down by the process of "localizing." On long lines it is necessary to use special tests which show the distance of the fault from the testing point, but on short local circuits the lineman simply cuts out a section and by proceeding in this way sooner or later reduces the trouble to one section. He usually knows the weak spots in each section—here the wire runs through a damp cellar, and there it rubs against a roof coping, and so on; and sooner or later he finds the particular spot which is causing the trouble.

Of course no circuit of any length is ever exactly balanced, in practice, and in the presence of very powerful inductive fields noise will inevitably be picked up. For example, nearby lightning will register on the best lines; high tension leaks, power plant troubles, certain types of automatic and multiplex telegraph circuits, will interfere on almost any loop near them. Even if a man has armor on, you can probably kill him with a sledge-hammer or an elephant rifle. The only answer is to keep away from trouble-making types of service as much as possible. However, various devices, such as shielded, paired cables; anti-noise sets, which slow down electrical impulses to a point where they no longer interfere, have been used with considerable success. Again, some types of interference clear themselves through the cessation of business activity in the early evening. Ticker noise encountered on a morning test of a certain circuit, which is to be used in the evening for broadcasting, may be ignored if it

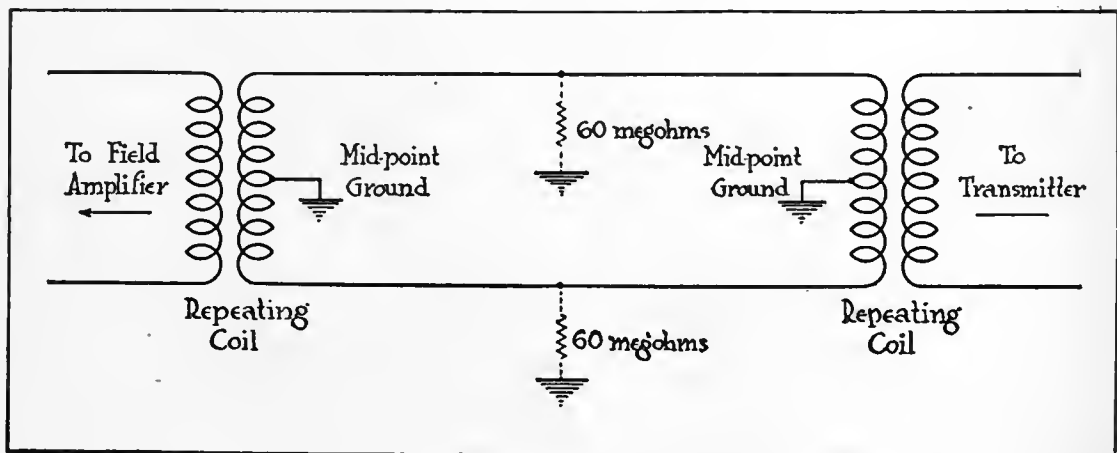

FIG. 1

Electrically symmetrical lines are necessary in outside "pick-ups." The diagram shows the circuit used. The field amplifier is controlled by an operator at the actual point of broadcasting

is known to come from certain financial houses which close down at 4 p. m. In case of emergency, it is sometimes possible to shut down parallel, interfering circuits during the period of broadcasting.

Broadcast operators and the linemen who work with them know all these kinks and utilize them in their work. The organization chart shown last month did not include a lineman among the technical employees, but as a matter of fact, although this man is usually not on the broadcasting station's payroll, he works in the closest cooperation with the station staff and is to all intents and purposes a member of it, and, if he knows his business, no mean asset.

Regardless of previous tests, it is important that every wire circuit which is to be used on a certain day for broadcasting, should be tested on that day some hours before the event is scheduled. Accidents often happen at the last minute. If the event is a very important one, such as a presidential broadcast, or a major prizefight, it may even pay to have the lineman around till the job is done on the air. For these occasions, also, it is quite necessary to have two or three pairs, one for broadcasting, one as a breakdown pair, and one for an "order wire." For ordinary jobs a single pair is generally sufficient. The operators talk over it until it is time to take the air, and use it for post-mortems afterward. Sometimes the wire is simplex or used for telegraph conversation during the broadcasting without interference between the two functions. This is not very common in local work, but it is the usual thing on long out-of-town circuits, where the cost of the line is so great that all its potentialities must be utilized.

Wire tests must not be left to any one's memory, but a log book, as shown in Fig. 2, is kept, showing the condition of the circuit at the time tested, and who is responsible for the observations.

It is possible to have one control operator in the station who is exclusively detailed for wire line work, but the usual procedure is to have the men rotate, so that everyone takes a turn at it. Often the station is on the air in the morning and the operator who runs the control room at that time also takes care of the wire line tests for the day, since as a rule the observations are quickly made, and there are long intervals between tests while the lineman goes from one remote point to another. In a large station one operator may be "on the channel," as the saying is—watching what goes out on the air and making necessary adjustments—while another man handles the wire tests and does maintenance work in the intervals.

One point that should not be neglected is the removal of all laterals not in use on any given trunk. Otherwise the laterals pile up, increasing the capacity of the line to the point where the higher frequencies are lost and quality of transmission is adversely affected. These sections hanging on uselessly may also bring in noise. In a properly maintained wire system the trunks are stripped of laterals at frequent intervals—and that does not mean every few weeks.

If the lines pass through telephone exchanges

or telegraph offices the utmost care must be taken to avoid interference by employees who don't know what is going on. The broadcasting lines should be red-tagged and a special notice sent around cautioning all unauthorized people to keep away. Most telegraph and telephone men have little notion of what broadcasting quality is and they will sometimes innocently break up a circuit in order to get a little amusement during idle periods. At one station it was noticed that music coming over a long line (some five miles) was curiously tinny—lacking in the lower frequencies. This was just the opposite of what one would expect—the suppression of the higher frequencies by the line capacity. The engineers were somewhat puzzled until one day one of them happened to be at the main telegraph office in the city in question and saw an idle operator plug a 60-ohm telephone into the jack panel of the broadcasting station, in order to listen to the music. The circuit was one terminating in 500-ohm impedances, so this low inductance was effectively by-passing all the lower frequencies. The engineer sent a 2000-ohm headset down to the telegraph office with a polite note to the wire chief suggesting that if the operators wanted to listen in they could use the high impedance telephones without ruining quality on the air. But the wire chief, receiving this epistle, flew high up in the air, returned the 2000-ohm phones with thanks and apologies, and posted a notice informing his staff that any one who plugged anything into those circuits without authority would be summarily fired. Then there was peace.

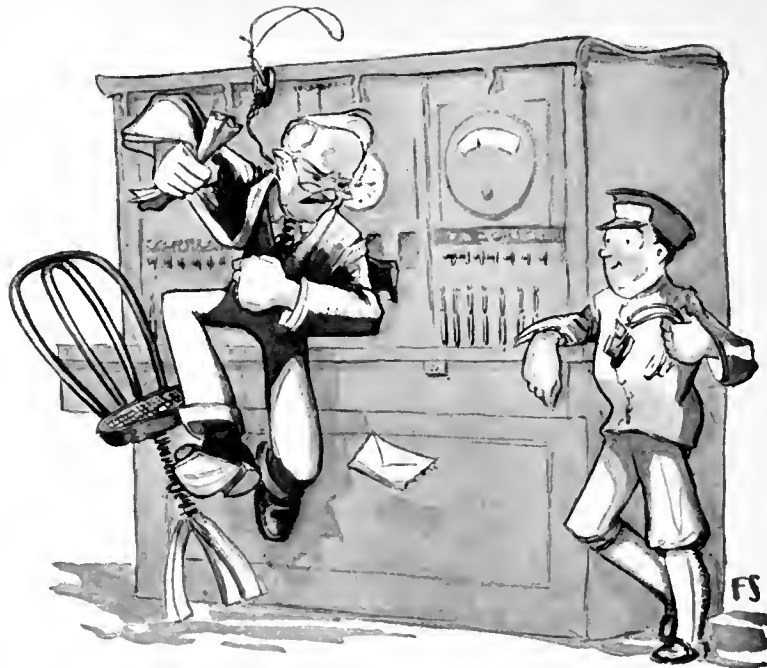

"THE WIRE CHIEF WENT UP IN THE AIR"

body, and the way in which people talk about them, all change with time. Not only do they change, but they show a tendency toward poetic figures of speech, and many terms which we use daily in the most matter of fact way, if we stop to examine them, show an interesting technical and literary history. This is particularly the case with radio terms, and I purpose to classify and discuss some of these, now popular expressions in the light of their origin and history.

Radio, contrary to the notion of many of its devotees, did not start in 1920. It had its period of development in the minds of men like Maxwell, Henry, Heaviside, and Hertz, it was born three decades ago, and it is now past its infancy. It has borrowed from all the older engineering arts both words and ideas. If, as someone has asserted, one can understand a thing only by understanding how it became what it is, an examination of the technical jargon of radio should be as instructive as an article on hook-ups and super-circuits—and a little more out of the ordinary.

*Physical Characteristics*

As in every field, the obvious physical characteristics of objects suggest suitable names. We speak of cat-whisker detectors, bulbs, tubes, condenser plates, plugs, knobs, etc. Position in space acts in the same way; *aerial* is the most prominent instance. The types of aerials are all named in the same way: umbrella, harp, fan, V, inverted-V, flat-top, inverted-L, and T. In these cases the name, or the figure of speech, was suggested by the physical appearance. Somewhat the same process occurs with inductance coils. We refer to inductance spirals and helices, and to honeycomb, latticework, basket-wound or cellular coils where the criss-

Radio Lingo, Past and Present

SOMEWHERE in his writings or conversations Anatole France compares a synthetic language to a doll, while a natural language, with its centuries of use, growth, and development, he likens to a living woman. On a more modest scale, the technical terminology of an art or science, as it reflects the achievements and changes of years of effort on the part of many men, takes on an almost organic meaning and color. We usually think of objects like antennas and microphones as purely inanimate and lifeless, forgetting that they are the tools of human aspirations and carry with them an emanation of human emotions. The names of these tools, and of the scientific ideas which they em-

FIG. 2

A typical test report made by broadcast operators on the condition of an outside wire used for picking up programs

LOOP NUMBER	TO	LEAKS TO GROUND		CONTINUITY	DATE	OPERATOR
		Tip	Sleeve			
465	Criterion Theatre	8	8	118	9/15/25	GN
...	.....	.	.	...	....	....
...	.....	.	.	...	....	....

crossing of the turns results in a cellular structure. This is the simplest and least imaginative portion of radio philology.

#### Figurative Expressions

If to call an aerial by that name is an obvious procedure—as well as a trifle out of date in those instances where the aerial has been taken in out of the wet to share the rarified atmosphere with the vases and porcelain dogs on the Dutch shelf of the living room—the term *antenna* is a step higher in the literary if not in the physical sense. This was originally a zoological name, applied to the organs of feeling with which lobsters, cockroaches, and other noble animals poke their way. No one who has seen an insect waving his antennae around when in an uncertain situation, confronted, for example, by an angry housewife with a mop, could have overlooked the analogy with a crystal set owner striving to receive Los Angeles from the Eastern coast. A radio antenna is, in fact, an artificial feeler or organ of sensation.

We speak of a "phantom" or "dummy" antenna, as used for testing purposes where radiation must be suppressed. Another figurative expression in connection with antennas is "counterpoise"—literally a counterweight—applied to a network of wires beneath an antenna, the purpose being to keep the electric field away from poor conducting materials, such as dry earth, and thereby to reduce the losses of the transmitting system. It might really be called a "counter-capacity."

### The Memoirs of a Radio Engineer VII

NOWADAYS radio gets the bulk of its publicity through broadcasting. Some famous opera singer performs for the radio, or the President delivers a speech, and the headline writers get busy. In the pre-broadcasting era, maritime disasters in which radio played a part were the principal source of publicity for the art. Of course, at that time there was a novelty about the whole business which has largely disappeared since, so that incidents like two stations exchanging messages over a distance of a few thousand miles, would get into the newspapers, while now no one pays any attention to them. But anything that saves human lives interests everybody, and it was in connection with accidents at sea that many people first heard of radio or had it called strikingly, often unforgettably, to their attention. It must be remembered that at this time, around 1910, communication with a vessel at sea was still a novelty. The act requiring passenger-carrying vessels making sea voyages more than 100 miles in length to be equipped with "wireless" was passed by the United States Congress in that year. It was not much more than ten years before that the first radio set had been installed on a ship. Along in the early part of the first decade of the Twentieth Century, it was still the usual thing for vessels carrying hundreds of passengers to leave land and not be heard from again till they reached their destination, or, in some instances, not to be heard from again at all. The sea swallowed them up, and that was all. After radio was introduced, such episodes became rare. Radio cannot prevent shipwrecks altogether, but a great percentage of them may be avoided by its use, and practically always help can be summoned when needed. That help may be only partially effective, or it may arrive too late, for, unfortunately, men and ships cannot be transported with the speed of the ether waves, and there are storms and situations

in which every ship has all it can do to take care of itself, but at least one has the consolation of knowing that what man can do was done. Before radio got into the picture, a vessel could burn up or founder with hundreds of people on board, and another ship near by might go on its way oblivious of what was happening. There is no tragedy like an avoidable tragedy.

It was in 1909 that through the intervention of radio such a tragedy was averted. The White Star passenger steamship *Republic* collided near Nantucket Light with the freighter *Florida* and sank some hours later. But before she went down she called for help on her wireless set, operated by Jack Binns. That call, picked up at Siasconsett, Massachusetts and by various other coast and ship stations, resulted in all the passengers and crew being taken off the *Republic* before she sank, and what would probably have amounted to a loss of hundreds of lives was limited to the six casualties which had occurred during the actual collision. The world sat up and took notice. Many people who had thought of the wireless telegraph as merely an interesting scientific toy, changed their minds overnight. Some of them bought stock in radio companies, not all of it good.

Three years passed, with the number of wireless stations and activities in general increasing rapidly. Then, once more, the aerial telegraph played its part, effectively enough, and yet it was not sufficient to obviate a great loss of life when the *S. S. Titanic*, then the largest ship in the world, sank 800 miles off the Grand Banks of Newfoundland, at 2 a. m., April 15, 1912, after striking an iceberg. The *Titanic* was driving through the night on her maiden trip, trying to make a record for the crossing (Those were the days of rivalry between British and German shipping interests) when her nose crashed into a "growler" of moderate size, but large enough to open the liner's compartments, so that she sank only a few hours later. Although the accident occurred in midocean, many vessels were near, and if the *Titanic* could have managed

to stay afloat six or eight hours almost everyone might have been saved. The nearest ship was the *Carpathia* and it was she who sped 58 miles, under forced draught, in three and one half hours, arriving at the scene of the disaster at 4.10 in the morning, to find lifeboats filled with survivors dotting the icy sea. The dead numbered 1635, among them Jack Phillips, the senior wireless operator, to whom the surviving 700 owed their lives, for it was his *CQD* and *SOS* calls that summoned the *Carpathia* to the rescue. Other vessels, the *Olympic*, the *Birma*, the *Virginian*, and the *Baltic*, were on their way, but turned around on hearing that the *Carpathia* had already done all that human sailors in iron ships could do.

Great as the service of radio proved on this occasion, luck and uncertainty played too great a part in what followed the collision of the ship and the iceberg. The *Titanic* carried an adequate transmitting set, with a day range of more than 400 miles and a night range which carried her cry of distress far over the sea, and yet she might easily have missed altogether the *Carpathia*, the one ship near enough to give quick assistance. It was also rumored at the time that one freighter, unequipped with radio, was even closer and might have taken off passengers who could not find a place in the lifeboats and whose lives ended shortly in the cold water. The fact was that the *Carpathia's* one operator, H. T. Cottam, was going to bed before the *Titanic* smashed her nose on the iceberg, and it was only by chance, or, if you please, the intervention of Providence, that he stayed up a little longer to get off some messages, and heard the *Titanic's* *CQD* buzzing into his headphones, at 12:35 in the morning. Cottam already had his coat off. Had he taken off the phones and grounded his antenna a few minutes earlier, the *Carpathia* would have continued tranquilly on her course while 2000 people were perishing 60 miles away. The necessity of a *continuous* watch by two or more operators was impressed on everyone

(To be continued)



MARINE RADIO GAVE THE ART ITS FIRST PUBLICITY

# The "ARISTOCRAT"

A Gallery of Interesting Models of the RADIO BROADCAST "Aristocrat" Receiver, Especially Adapted for the Phonograph Cabinet—the High Quality Audio Channel is Assured by Resistance-Coupled Amplification

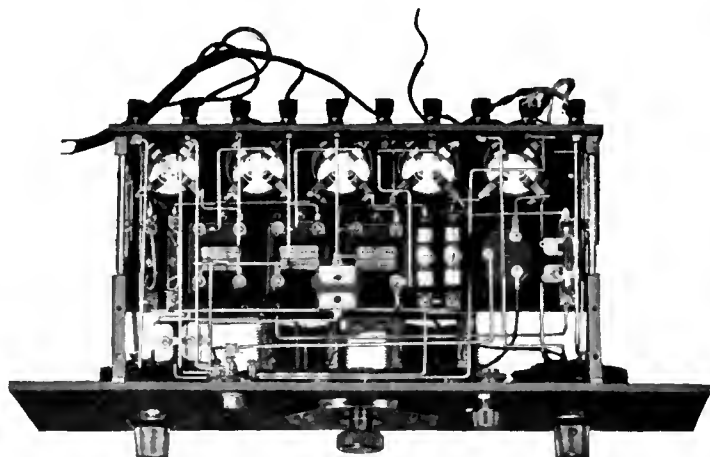

FIG. 2

This is a bottom view of the receiver shown in Figs. 5 and 8. The filament circuit in this receiver has been somewhat altered in that  $\frac{1}{4}$ -ampere ballasts, one each, have been used in the detector and radio-frequency amplifier filament circuits. A half-ampere ballast is used in the first two audio tube circuits and another is used in the output tube circuit. Where six-volt tubes are used instead of the five-volt type, short pieces of bus wire may be employed in place of the ballast resistors as indicated at the left hand side of the illustration, where two such base connections have been made. It will be noted that in this receiver Brach resistance coupling units and Brach ballast resistors have been used

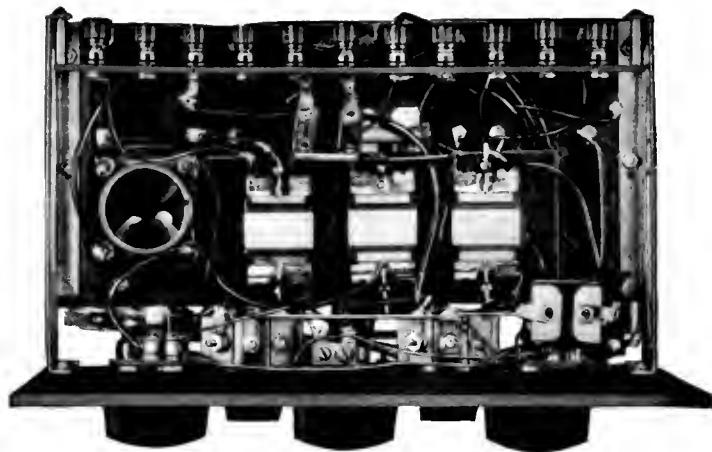

FIG. 1

One of the Phonograph Receivers described in RADIO BROADCAST for June, July, and August, converted into a RADIO BROADCAST "Aristocrat" by the addition of one tube and by replacing the transformers with Dubilier condenser and resistance units for making a resistance-coupled amplifier

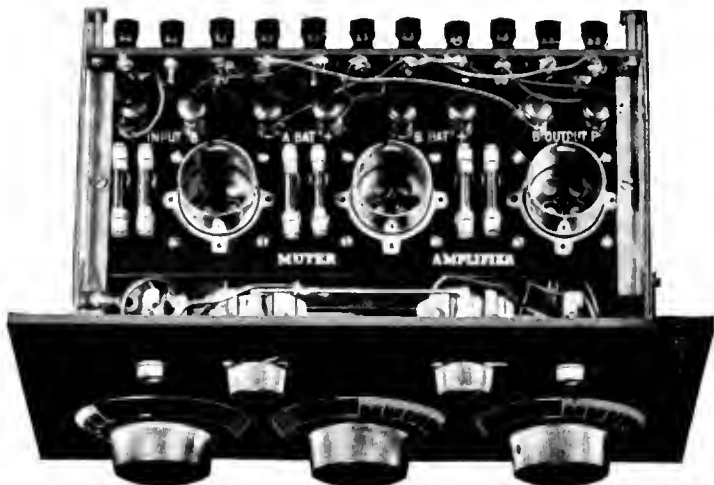

FIG. 3

Another RADIO BROADCAST Phonograph Receiver converted into an "Aristocrat" by the use of a three-stage Muter resistance-coupled amplifier

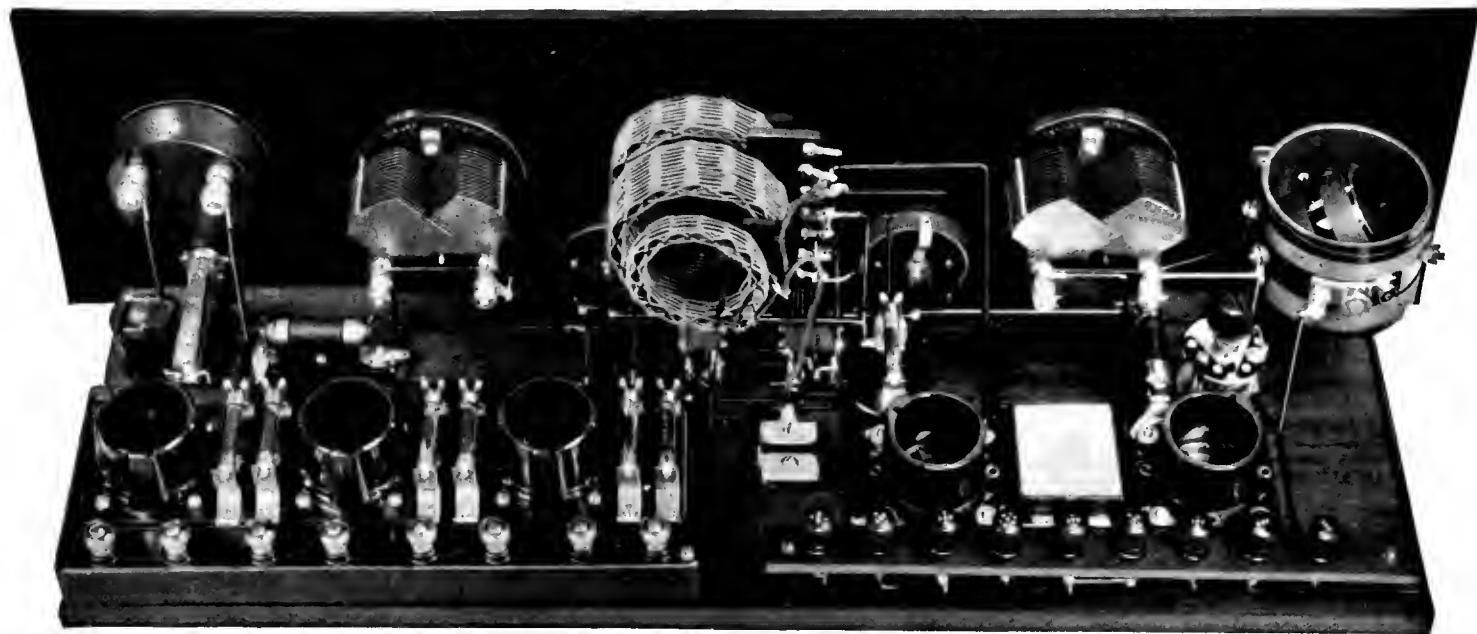

FIG. 4

This RADIO BROADCAST "Aristocrat" was made by Radio Research Laboratories, New York, and they have incorporated some slight modifications of their own, which are to be commended. For instance, the General Radio variocoupler used in the antenna circuit makes it possible to compensate for various antennas without tap switch. The voltmeter has a multiplier in series as it is one of the double scale type. Victor coils have been used in the radio frequency unit, and they have been found very satisfactory. Two Pacent 10-ohm rheostats are employed, one in the detector circuit and one in the radio-frequency amplifier circuit. The latter makes a particularly good volume control. The entire assembly is an example of the kind of workmanship that any home constructor may accomplish if he will devote himself sincerely to the job



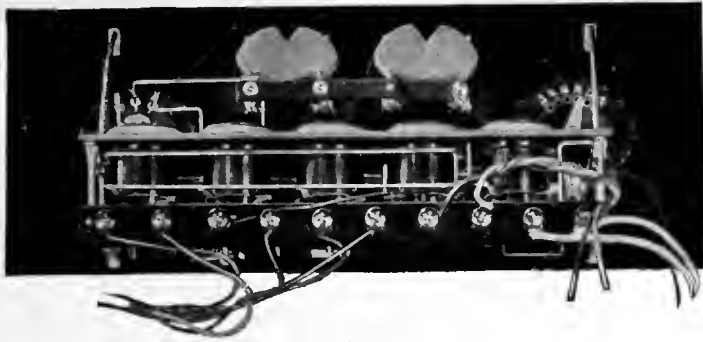

FIG. 5

This is a rear view of the receiver shown in Fig. 8. The simplicity of the layout is brought out thoroughly from this viewpoint. It will be noted that the sockets extend far enough beneath the sub-base to allow wiring to be made at approximately the level of the socket prongs. The manner of fastening the sub-base and binding post strip to the Bruno bracket is very satisfactory and very substantial

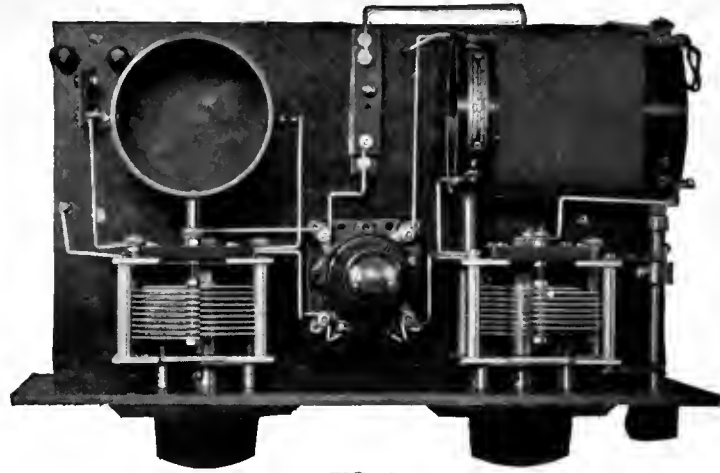

FIG. 6

A Phonograph Receiver using the National Regenformer Kit and the Browning-Drake circuit with a Heath resistance coupled amplifier unit. A 199 tube used in the radio frequency part of the circuit to save current and facilitate neutralization



FIG. 7

This is the under side of Fig. 6. The small resistance in series with the right hand rheostat is used to reduce the current from the storage battery to a point where operation of the 199 tube is possible without overloading. The use of a three-stage resistance-coupled unit in receivers of this kind makes the entire wiring job a simple one. The arrangement illustrated in Figs. 6 and 7 is very neat and the performance of the receiver is such that we do not hesitate to recommend it for those who desire a really good receiver for installation in their phonographs

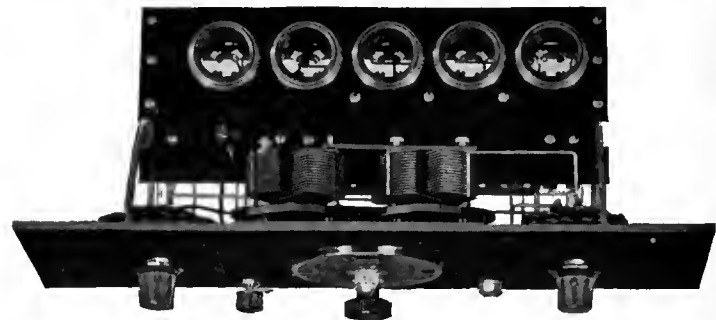

FIG. 8

Another RADIO BROADCAST "Aristocrat" receiver. The panel itself is but 18 inches in length and there is plenty of room left at either end. Specially designed coils for the "Aristocrat" receiver, made by the American Mechanical Laboratories, have been incorporated in this model and the movable tickler is replaced by a variable resistance. This unit with the primary and secondary radio frequency coils is called a Clarotuner. Bruno brackets have been used and the sub-base has been made to our design by the Osborne Company of Boston, Massachusetts.

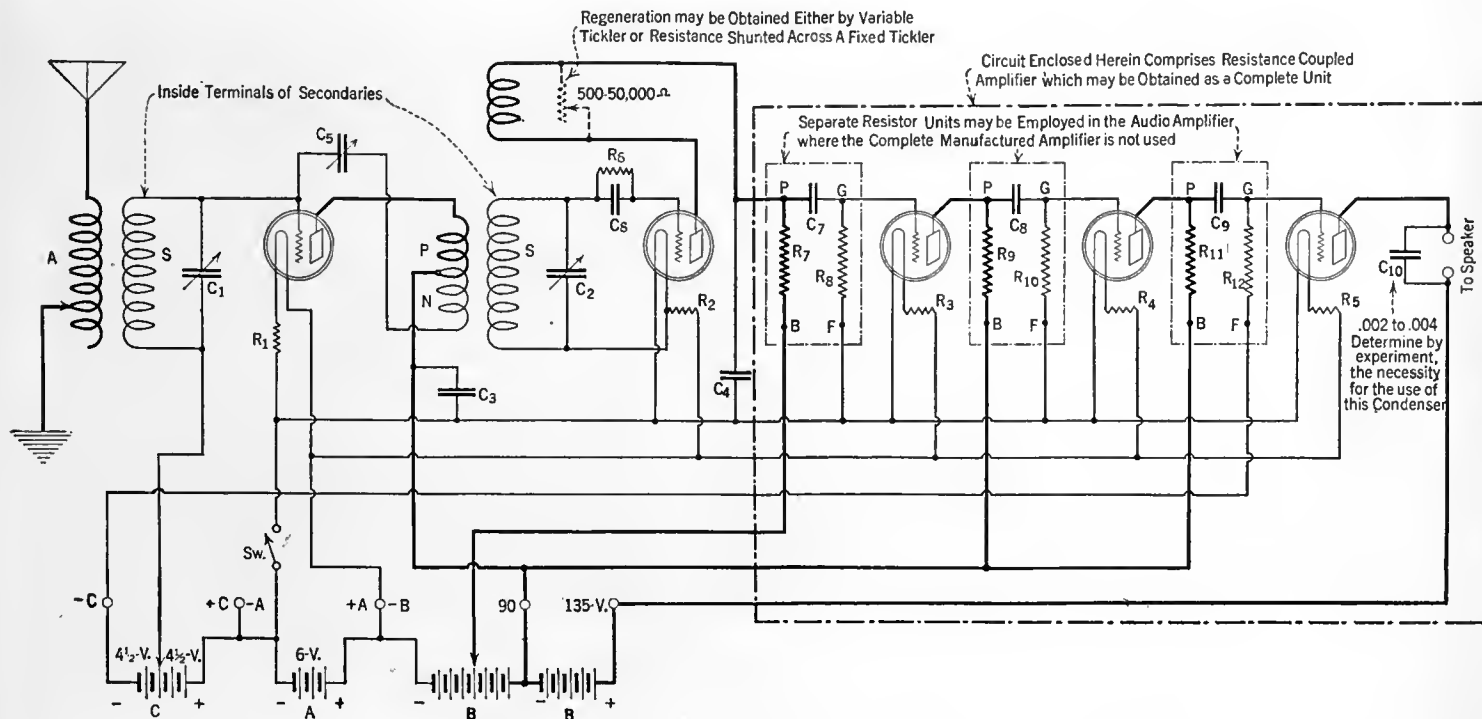

FIG. 9

This is the circuit diagram of the RADIO BROADCAST "Aristocrat". Note that the connections of C3 have been altered. They were incorrectly shown in the diagram accompanying the constructional article on this circuit on page 30 of RADIO BROADCAST for November. A .5 mfd. condenser should be tried across the B battery, which may improve the tone. Amperite ballasts may be used for filament control in each of the tubes

# How to Use Meters in Your Receiver

*The Meter is a Comparatively Inexpensive and Valuable Refinement—How Meters Work and How to Use Them for Best Results*

By JAMES MILLEN

**N**OT a few broadcast listeners have the idea that meters in a radio receiver, if they are built in at all, are there for appearance and not for any good they may do in enabling the operator of the set to use his receiver more effectively. Of course, everybody knows that a set will work without a meter, but few know how much the proper meters will help in obtaining economy and quality performance.

A small voltmeter, connected in the filament circuit enables one quickly to turn the control rheostats to the proper point so that enough current is flowing

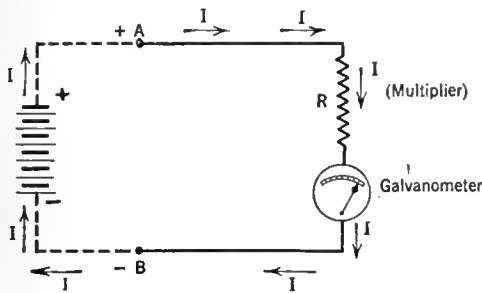

FIG. 1

This diagram shows how a resistance and a current measuring device are employed to determine voltage

through the circuit to heat the filament wire to insure emission of electrons in the proper quantity. This is one of the conditions for the production of good quality. At the same time, the filament is not operated above its rated voltage. This prolongs the life of the tube. When a tube is used with a very slight increase over its rated voltage, its life is greatly reduced.

Depleted B batteries are frequently a source of noise and distortion in radio

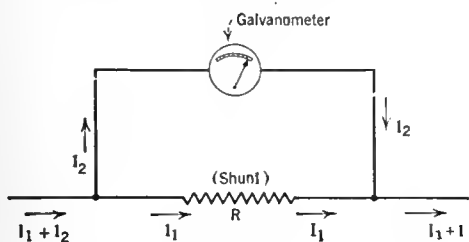

FIG. 2

A shunt resistance is employed in order that only a small percentage of the total current in the circuit passes through the meter

**T**HIS article might have an alternative title, "How to Get More Out of Your Receiver," for that is exactly what will happen if Mr. Millen's suggestions are followed. It is easy enough for anyone to tell how a radio receiver is operating acoustically, but electrically, meters are required to tell the operator how the circuits are functioning. The addition of the proper meters to any set is neither an inordinately expensive matter nor a very difficult one. The mere assurance that one is using his tubes at the proper filament voltage is enough reason for installing the meters. In addition, the use of a plate current milliammeter will register instantly the slightest distortion occurring in the audio circuit, after the fashion described by Mr. Crom in his article in RADIO BROADCAST for October. Mr. Millen's excellent suggestions can aid every home constructor and not a few of those who have manufactured sets which they would like to improve.

—THE EDITOR.

receivers. And when, as is frequently the case, the B batteries are located in the cellar or some out-of-the-way place, it is inconvenient to test them frequently with a pocket voltmeter. So they are often neglected and as a result the quality of reception becomes poorer, all unnoticed by the owner, because the process is gradual. But some evening, when the receiver is put into operation it refuses to work. Had the set been provided with a conveniently arranged panel voltmeter, the operator could have made a frequent and easy check on the condition of the batteries.

The third meter which helps toward good quality and economical operation is a plate-current milliammeter. A plate milliammeter primarily indicates the rate at which energy is being drawn from the B batteries. If this plate current is excessive, the life of the batteries and the tubes will be seriously impaired. By means of proper C voltages it is possible to vary the plate current and thus secure the value specified by the manufacturers of the tube for any given plate voltage.

A second, but not a lesser important function of the plate milliammeter, is to indicate how an amplifier tube is "modulating." For quality reception it is absolutely essential that the d. c. component of the space current of a tube, as indicated by a d. c. milliammeter does not vary. If the needle on the milliammeter drops down on a strong signal, the tube is said to be "modulating down" and the C voltage must be increased. If, on the other hand, the needle advances on a strong signal, the amplifier is said to be "modulating up," which indicates that the C voltage is too high for the plate voltage being

used. Should the needle fluctuate violently in both directions, the tube is very much overloaded and both B and C voltages must be materially increased.

## MANY USES FOR METERS

**T**HERE are also a number of other uses for meters in connection with radio receiving sets, but with the equipment as available at present, their use is of value mainly in the laboratory. Such a meter is an ammeter for indicating the rate at which a storage battery is being charged. As the charging rate on the majority of home battery chargers is not variable, there is little to be gained by the use of a meter in such cases.

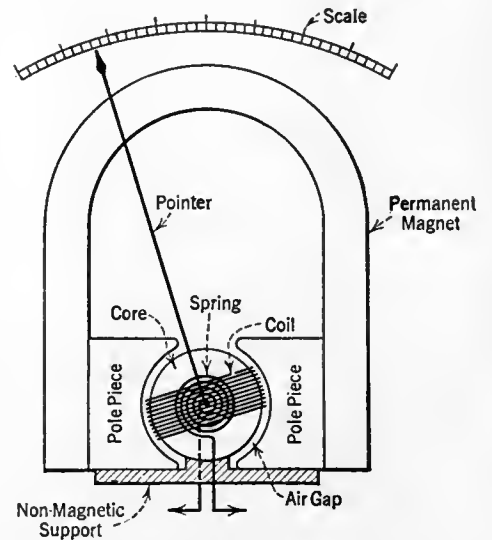
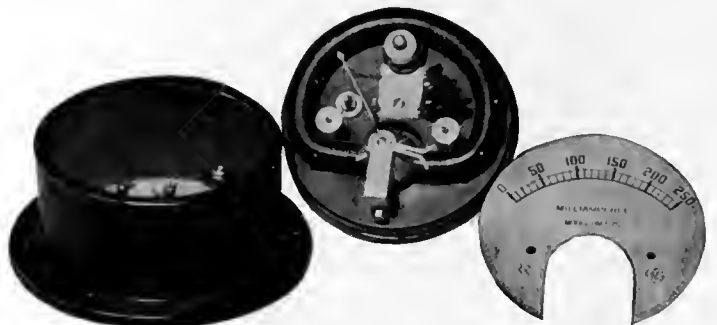

FIG. 3

The most accurate meters are of the moving-coil type, such as shown in this diagram. The photograph below shows a meter of the moving coil type, apart. The D-shaped piece on the base of the meter, center, is the permanent magnet



RADIO BROADCAST Photograph

FIG. 3A

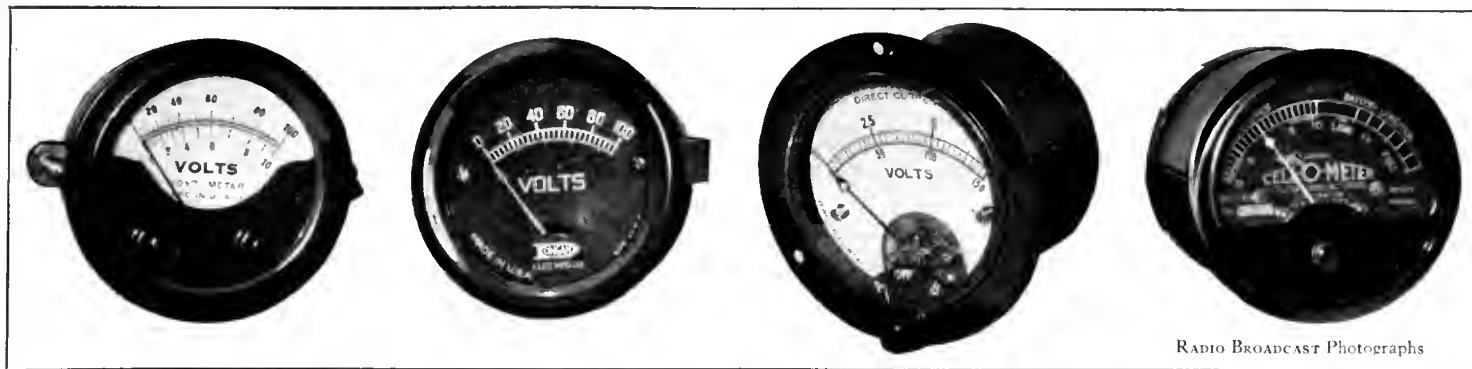

RADIO BROADCAST Photographs

FIG. 4

There are a number of different concerns making meters for radio use. The products of Hoyt (Burton and Rogers), Dongan, Jewell, and Cellokay are shown

Another such meter is a wavelength or frequency meter, but this too may be dispensed with in the modern radio broadcast receiver by the simple expedient of calibrating the dials on the receiving set.

All of the meters referred to above with the exception of the wavemeter are fundamentally the same—that is, they are essentially galvanometers, or devices for indicating current flow. If a voltage is to be measured, then a high resistance unit, called a multiplier, is connected in series with a galvanometer and the combination connected to the source whose voltage is to be measured. This arrangement is shown in Fig. 1. A small current will flow through the resistance and galvanometer. The galvanometer will indicate the value of this current. Now, by means of one of the fundamental laws of electricity, it is possible to compute the voltage readily across the terminals A, B, Fig. 1, as the value of the resistance, R, and the current I, are known. This, known as "Ohm's Law," says that the voltage across a resistance due to current flowing through the

resistance is equal to the product of resistance in ohms and the current in amperes, which, in symbols is  $E = IR$ .

Of course, it is not convenient to make even this simple calculation every time one wants to know the voltage of his batteries, so the manufacturers put a special scale on the galvanometer which reads directly in volts. Then they go still another step farther and build meters having an inherent resistance of such a magnitude that, for voltages under say 50 volts, the use of an external resistance or multiplier is dispensed with. For higher voltages, such as B battery voltages, it is generally customary for the meter manufacturers to take a lower voltage meter, such as one having a range of 10 volts and making a multiplier which will give a range of 100 volts. The scale on the meter is then frequently a double one, so

that either the 0-10, or 0-100-volt scale may be referred to depending upon whether or not the multiplier is being used.

Ammeters are also fundamentally galvanometers, which would be burned out if a heavy current were to be passed through them. In order that they may be used to measure heavy currents, resistances are connected across them so as to "bypass" most of the current and thus let only a small fraction of the total current pass through the meter. This "by-pass" resistance is known as a shunt and in the case of the small panel mounting type of milliammeters used for radio work, the shunt generally consists of a small piece of resistance wire contained within the meter case.

FIG. 5

External cased meters may be placed as shown on a previously built set. The voltmeter at the left shows filament volts, and the milliammeter at the right indicates B battery consumption. Both are Weston meters

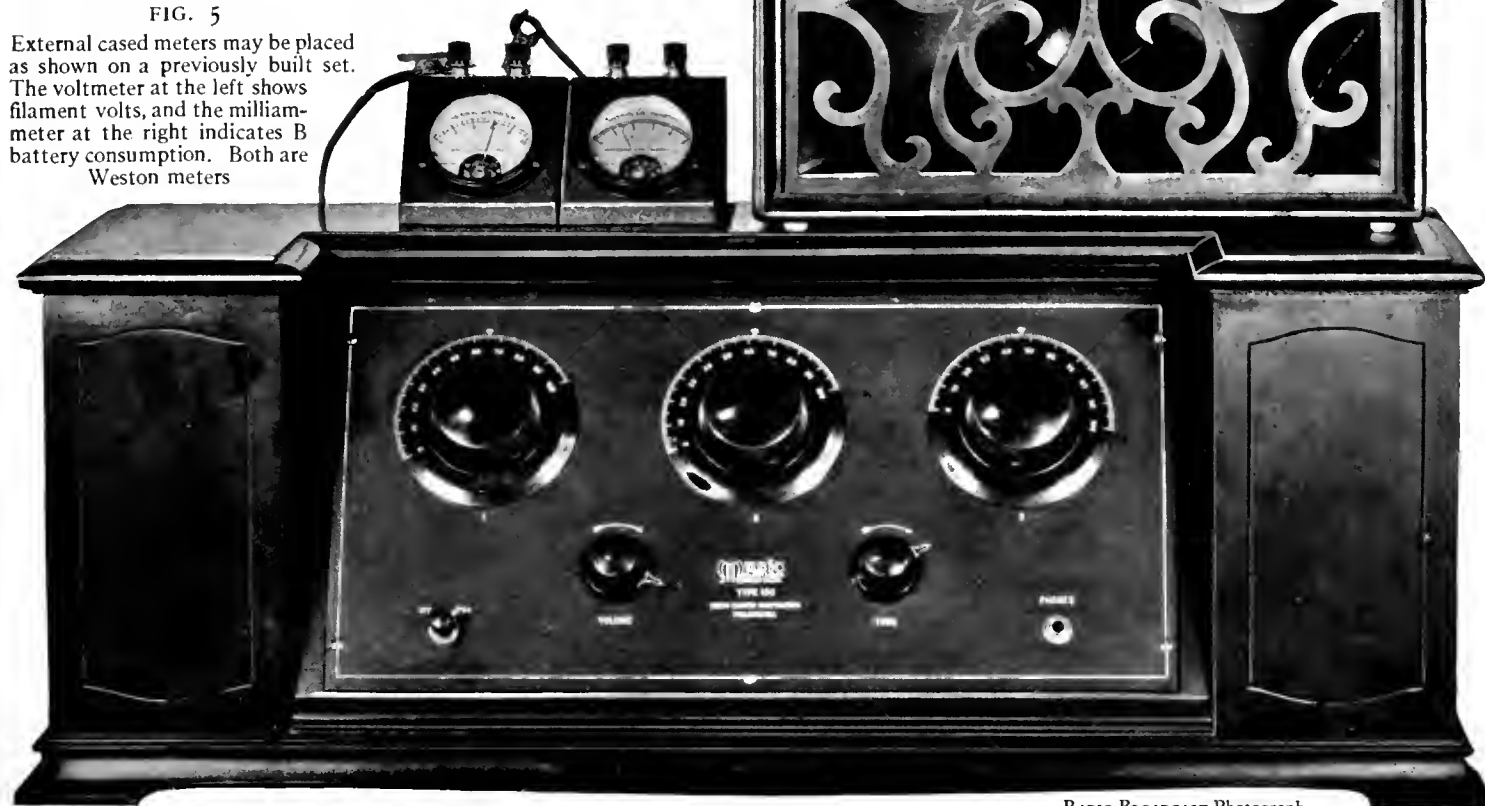

RADIO BROADCAST Photograph

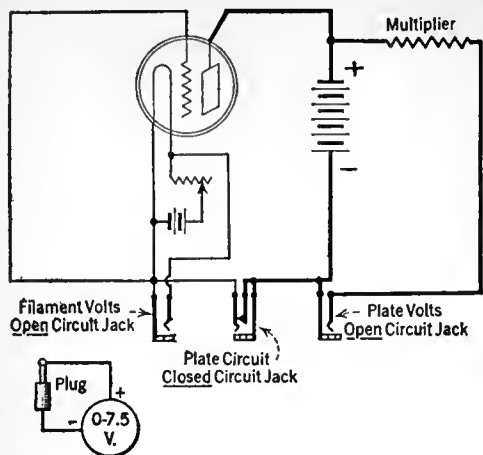

FIG. 7

By connecting three jacks in each tube circuit, it is possible to use one meter for many different purposes. In order that several different multipliers will not be required, one multiplier may be arranged with a short-circuiting switch in the plug circuit

HOW THE METER WORKS

THE galvanometer units generally, in the higher grade instruments, consists of a movable coil, to which is affixed a pointer, pivoted in a strong magnetic field set up by a permanent magnet of the "horseshoe" type. This arrangement is illustrated in Fig. 3. When a current passes through the coil, an electro-magnetic field is set up which reacts with that set up by the permanent magnet and the coil tends to rotate. It is held back by a small hair spring. The force (or as it is technically called, torque) tending to rotate the coil is directly proportional to the current flowing through the coil. Furthermore, the deflection of the coil is governed by the spring, whose deflection with certain limits, is directly proportional



FIG. 9

This is the panel view of the "Aristocrat" receiver shown in Fig. 4 on page 196 of this issue. The switch below the meter at the right side of the panel allows the meter to read either filament or plate voltages

to the torque. Thus the deflection of the galvanometer is directly proportional to current.

Instruments, such as the Weston and the Jewel employ the movable coil type of movement illustrated in Fig. 3. The less expensive meters, especially the small pocket volt and ammeter used for testing dry cells are of what are known as either the plunger, and iron vane type.\* The iron vane type consists of a small electro-magnet with a soft iron core. When a current is passed through the winding of the electro-magnet a small iron "vane," which is mounted on a shaft, is attracted. The vane is held back by the permanent magnet, and a pointer is affixed to the shaft so as to indicate the deflection.

The electro-magnet in an ammeter of this type consists of a half dozen turns of very heavy wire, whereas the voltmeter electro-magnet is wound with many turns of very fine wire.

In the past, instruments of the iron vane type have not been considered very accurate for high grade work. Furthermore, they consumed considerable power, and

thus could not be left in a circuit for any length of time, as they would run the batteries down. This is especially true of voltmeters since they are shunted across the supply and if left in circuit would deplete the batteries very rapidly.

At present, however, there are at least two well-known concerns manufacturing improved instruments of this type which are well suited for radio use, particularly for measuring B battery voltages. Such a meter mounted on the panel of a tuned radio frequency receiver is shown in Fig. 8. Two push buttons are provided so that either the detector or the amplifier B voltages may be instantly read with the same meter. When push-buttons are used for this purpose there is no danger of the meter remaining connected to the B batteries for long periods and thus unnecessarily running them down.

Fig. 4 shows a group of different meters for mounting on the panel of a radio receiving set. The meters may be mounted in small cases, and connected to the set with flexible lamp cord. Such an arrangement is shown in Fig. 5.

Fig. 6 shows how these meters are connected in a RADIO BROADCAST Four-Tube Knockout receiver. By carefully examining the way in which the meters are connected in this circuit, the manner in which they should be connected in any circuit will be evident.

If a meter is equipped with an ordinary phone plug and flexible cord, jacks may be arranged on the panel of the receiver so that it may be plugged into any part of the circuit. Fig. 7 indicates how to connect the jacks in a circuit.

Instead of having three separate meters —A voltage, B voltage, and plate current— for use with the set in Fig. 7, one meter may be made to serve the purpose most excellently. If a 0 to 7.5 voltmeter is available it may be used directly to read filament volts, with a resistance in series (8825 ohms for Weston 0-7.5-volt No. 301) to read up to 150 volts (multiply scale readings by 20) and without any attachments, as a milliammeter. For the model 301 Weston meters, a full scale deflection requires 16.1 milliamperes or for the 0 to 7.5 volt Weston meter, each division is equal to 2.146 milliamperes or approximately 2 milliamperes.

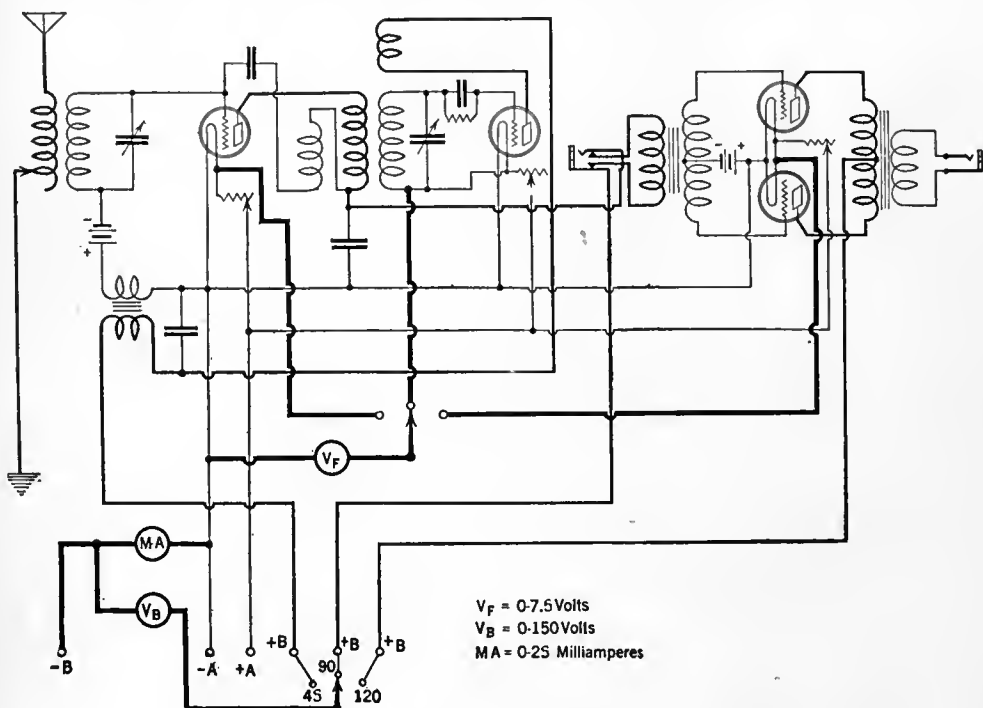

FIG. 6

This circuit diagram shows how to connect a filament voltmeter, a plate voltmeter, and a plate milliammeter in a RADIO BROADCAST Four-tube Knockout receiver

# New Fields for the Home Constructor

The Second of a Series of Articles—Each Complete in Itself—Showing the Jaded Home Builder How He Can Use His Present Equipment to Make Valuable and Useful Measurements and Experiments in His Own Home

By KEITH HENNEY

Director, "Radio Broadcast" Laboratory

**T**HERE can be little doubt that radio is one of the most attractive fields for home experiment that has ever offered itself to the average layman. The ramifications of this specialized part of electrical engineering are so many and so varied that "that tired feeling" of having solved all is always far in the distance, and the home experimenter, with inexpensive and not too complicated apparatus, can approach so closely to actual scientific research that he cannot help attaining a distinct feeling of having accomplished something of value at the end of each day's experiment.

For a long time the Editors have been sure that there were many who felt they had built enough receivers, but who still had a craving to construct something with their own hands that would work in some useful way. Tools accumulated through days of receiver building cannot lay idle; radio junk collected during those same days, is always too good to throw away; experience in radio matters causes a yearning for more experience—and yet, to build one more receiver might be the breaking of the proverbial camel's back. What is the home constructor to do?

This series of articles, of which this is the second, has been planned with but one object in view, to lead these jaded souls into a field where there is endless variety, and where each thing accomplished leads to something else. And for those who really want to know more about radio, who want to find out for themselves what is going on behind laboratory doors, these articles will be written so that they will be in some degree helpful. The home constructor naturally fits into the field of radio experiment since he has already tasted the joys of building successful apparatus, and in this way he has learned the "feeling" of electrical equipment

The first article, in the September number, described a simple piece of laboratory equipment that is efficient enough to grace the best laboratory, useful enough to make it worth while for any one to build, and at the same time inexpensive and not compli-

cated. It is a two-tube oscillator, one of the tubes working at broadcasting radio frequencies, and the other at a fixed audio frequency. Either tube may be used alone, or the two may be operated together as a source of modulated high frequency energy.

## USES OF AN AUDIO OSCILLATOR

**F**OR example, the audio part of the oscillator referred to above is used in the Laboratory of RADIO BROADCAST for the following purposes:

1. Source of tone for testing open circuits.
2. Tone for measuring capacity, inductance, or resistance.
3. Measuring the characteristics of audio instruments, such as audio-frequency transformers, loud speakers, etc.

It is common practice among radio workers to use a battery and a pair of headphones to test open circuits, and at times a dry-cell operated buzzer is used. For example in a receiver which is inoperative due to a broken connection, the wiring may be traced until the break is found.

In testing audio frequency circuits in which transformers are used, it is extremely bad practice to use direct current for testing. After such a test it may be found that the iron cores are magnetized with the result that distortion occurs when the amplifier is again placed in operation. In the laboratories of the telephone companies, where hundreds of telephone transformers are used, it is strictly against the rules for laboratory assistants to "buzz" out circuits either with the phones and dry cell or with a buzzer.

The 1000-cycle tone emitted by the

audio oscillator described in the September article, is an alternating current of small amplitude which cannot magnetize the cores of any transformers. Fig. 1 shows the usual method of testing open circuits with battery and headphones, as well as the correct method of using the audio oscillator as a tone tester. The jack in the oscillator provides an outlet for the 1000-cycle tone and a plug in this jack will have the alternating voltage across its terminals. One terminal should go to the receivers, and the remaining wires, one from the oscillator and the other from the phones, should go across the suspected broken connection.

Capacity and inductance, as well as alternating current resistance, are measured by what is known as an "impedance bridge" which operates from a source of alternating current. The audio part of this oscillator is again useful here, and Fig. 2 shows how it is used in the Laboratory. It is not necessary to have much power for work of this kind, and if extraneous noises make it difficult to get proper balance on the bridge, a one- or two-stage audio amplifier is connected to the bridge and thence to the receivers. For example, in the Laboratory, the noise and vibration from presses, in action several floors below, makes it difficult to obtain correct measurements, without the aid of the amplifier shown in Fig. 2.

A simplified form of bridge will be described soon in this series and, with the aid of the audio oscillator, will enable the experimenter to measure his own inductances and capacities just as is done in any large and well equipped laboratory.

This will eliminate much of the cut-and-try method that is now in order when the radio builder decides to make new coils, or to try different sizes of condensers to tune to certain frequencies. The bridge shown in Fig. 2 is made by the General Radio Company.

By varying the tuning condenser across the secondary of the oscillator, notes may be secured varying from about 200 cycles to the natural frequency of the transformer itself, which is usually around 5000 cycles. These tones may be amplified if necessary,

---

**T**O SHOW how the home constructor can go on in radio after he has built the radio sets that to him are satisfactory, is the purpose of these articles. The first "What Is to Become of the Home Constructor?" appeared in this magazine for September and has created a phenomenal amount of interest. Each of these articles really gives a complete set of experiments and useful tests which may be made by any experimenter who is properly equipped. The apparatus, most of it at least, in the form of parts, is in the radio "junk pile" of almost every constructor. Each article is complete in itself, the experiments are related and they have a very definite use in any one of a number of ways. Using the audio oscillator to test receivers and the radio oscillator to calibrate them, is, for example, of great use to radio dealers who take pride in their repair and service departments. The uses of the radio oscillator suggested here are novel and ingenious and bound to be helpful. Those who are interested in laying out a modest little "lab." of their own will be interested in the suggestions given at the end of this article.—THE EDITOR.

---

and used to determine the characteristics of audio-frequency transformers as well as the resonance peaks which exist in many loud speakers. Methods of testing these low frequency instruments will be described later. Calibrating the oscillator is not difficult provided access is had to a musical instrument that is accurately tuned.

Middle C on a properly tuned piano corresponds to a frequency of 256 cycles per second, and is a good starting point for the calibration of an audio oscillator. The tuning condenser should be varied until the sounds emitted by the piano string and the oscillator are the same. Other frequencies may be obtained in the same

manner. The relation between frequency and the piano scale will be shown graphically in the January RADIO BROADCAST.

Tuning forks may be purchased from musical supply houses and a small set, say, those of 256, 512, 1024, and 4196 cycles, will enable any one to calibrate an oscillator.

USING THE RADIO OSCILLATOR

In the Laboratory, the radio



FIG. 1  
A source of pure alternating current is useful in testing audio-frequency transformers. There is no danger of magnetizing the cores when such a tone source is used. The battery "click" method is dangerous. An Erla cruciform audio transformer is being tested in this view

RADIO BROADCAST Photograph

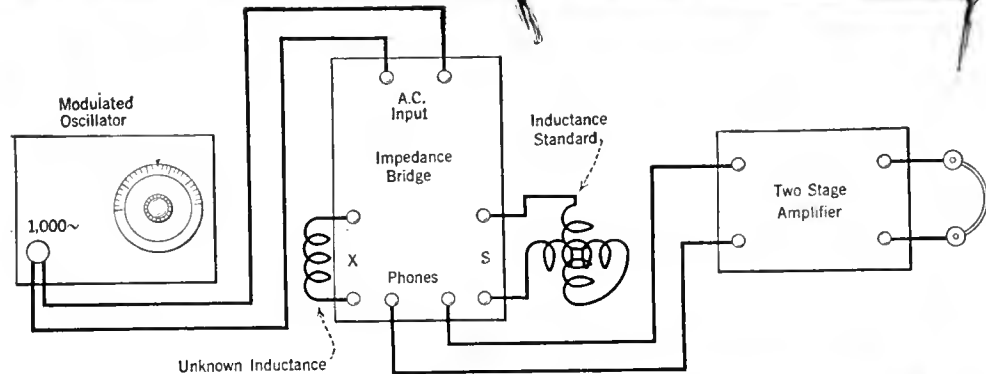

FIG. 2

An impedance bridge for measuring inductance or capacity requires a source of alternating current. In this laboratory arrangement, the modulated oscillator furnishes the tone, and a General Radio Inductometer is used as a standard of inductance by which the toroid is being measured. The other apparatus is a two-stage audio amplifier and telephone receivers for obtaining an audible balance. The picture diagram above shows how the apparatus is connected

part of this simple device is used for the following purposes:

1. Calibrate receiving sets.
2. Set receiver for a given frequency.
3. Measure the frequency of incoming signals.
4. As a separate oscillator for superheterodynes.
5. Source of radio frequency energy for measuring losses in coils, etc.
6. Wavemeter.
7. Energy for neutralizing receivers.

As an example, let us suppose that a new receiver is constructed and we are desirous of finding out what frequency band it will cover. We crank up the oscillator and tune the receiver to it. Noting the dial numbers of the receiver, we change the frequency of the oscillator and again tune the receiver. In this manner we

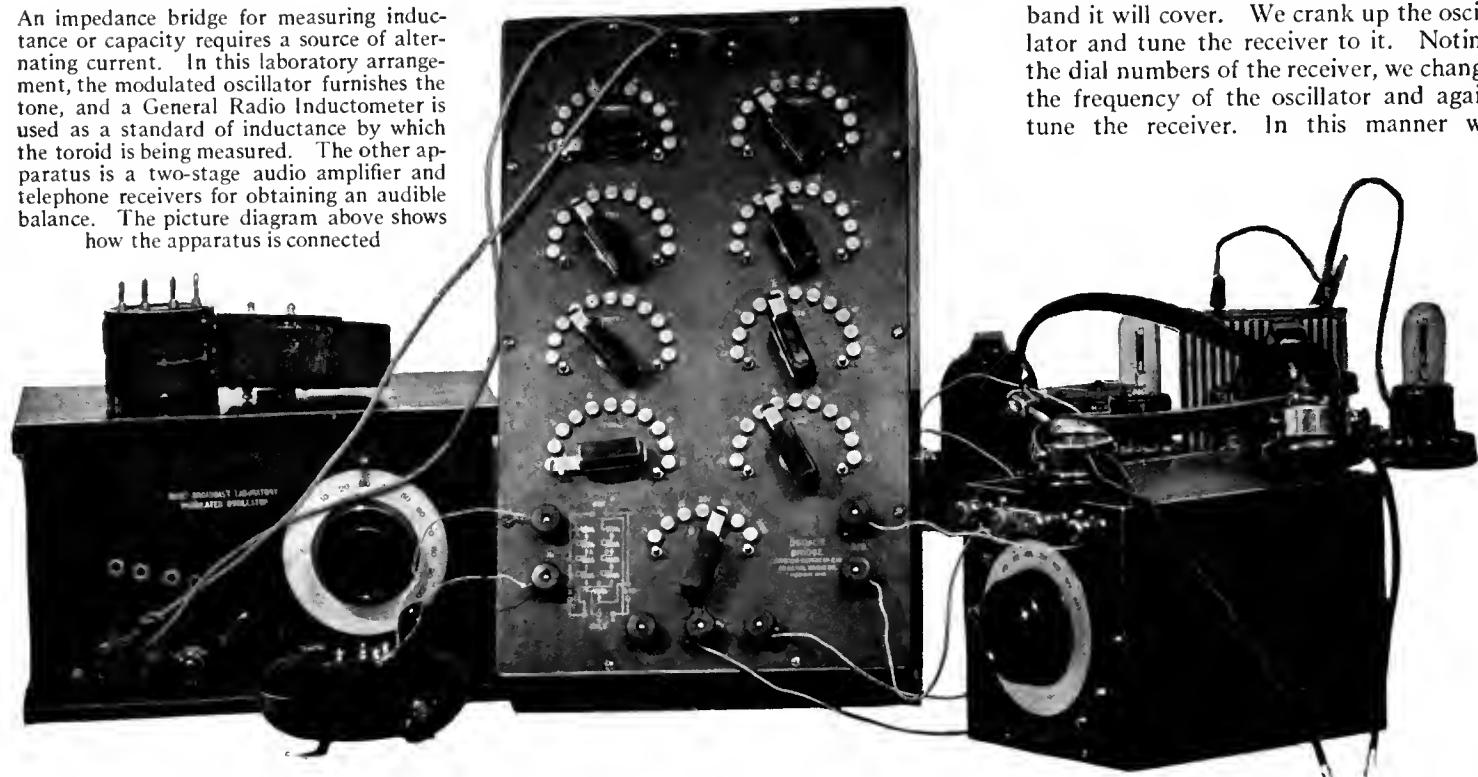

RADIO BROADCAST Photograph

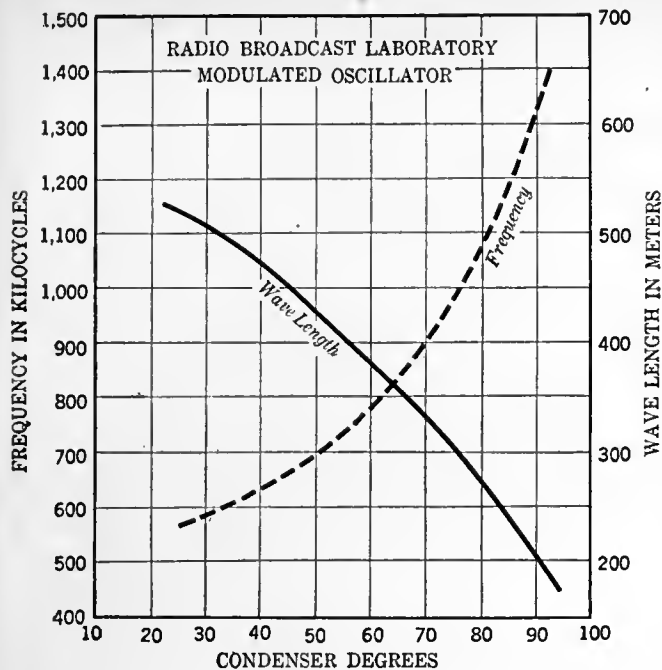

FIG. 3

A calibration of the Laboratory's oscillator. Both frequencies and wavelengths are plotted against condenser settings. This calibration will be true only of the coil and condenser used in this particular case. All other combinations must be calibrated against standard frequency signals either from a known broadcast station or from the standard frequency signals sent out by the Bureau of Standards

may have an exact tuning curve of the receiver before a single station is heard. Fig. 3 shows a calibration of the radio part of the Laboratory's oscillator. This of course will differ for each coil and condenser used and the effect of connections will not be negligible.

This means that each constructor will have to calibrate his own oscillator, but at night this is not a difficult task. With both tubes functioning it is only necessary to tune a receiver to a known station. Then the oscillator is varied until the tone is heard in the receiver. Now that radio stations stay closely to their required frequencies, it is possible to own a very accurate wavemeter using this simple means of calibrating it.

Incoming signals on any receiver may be measured for their frequency by tuning the oscillator until it is heard together with the stations signals. A glance at the calibration will show what station is being received.

The receiver may be set at a required frequency by setting the oscillator for this frequency by means of its calibration curve, and then tuning the receiver until the sound is heard. In other words, the modulated oscillator will make a good wavemeter, and due to the fact that both audio and radio waves are tube-generated they will be very sharp. The old time buzzer with sparking contacts is notoriously broad in the frequency spectrum it turns out.

USE IN NEUTRALIZING RECEIVERS

THERE is another use of the radio part of the apparatus that is very important, and in the Laboratory it has

been used many times for this purpose and may easily find the same use in many home laboratories. This is the neutralization of radio-frequency amplifiers. Tuning-in a signal and then, with the radio frequency tubes turned out, to adjust the neutralizing condenser until no sound is heard is one method, and the modulated oscillator, with both tubes burning, provides a good source of energy for this purpose.

There is another method that may be used, especially where a regenerative detector is in the circuit, and it is somewhat more accurate. This is particularly true if high gain amplifiers are used, characterized by many plate turns in the amplifier coils, and correspondingly large fields.

The detector is made to oscillate, and with the radio frequency tube of the oscillator set at some frequency in the middle of the broadcast band, the detector tuning

condenser is varied until a beat note between the detector current and that emitted by the oscillator is heard. Then the radio-frequency amplifier condenser is varied. If the amplifier is not properly neutralized, the beat note will change pitch rapidly as the amplifier is tuned. If far from the neutralizing point, the amplifier may oscillate, or reaction between the amplifier and detector may be so great that the detector will refuse to oscillate.

The neutralizing condenser is then varied until changing the amplifier tuning has little or no effect upon the detector circuit. This balanced condition will be noted when the beat note between detector and oscillator does not change appreciably when the radio-frequency amplifier is tuned.

Since it is not always possible to pick up broadcasting stations, especially where

constructors are out of the daytime range, the oscillator provides an excellent source of both pure radio and modulated radio frequency energy for neutralizing purposes.

TO GET GREATER ENERGY FROM THE OSCILLATOR

FOR some purposes it is necessary to have greater power than is turned out by the wd-12 tubes used in the Laboratory oscillator. In this case it is only necessary to use standard 5-volt tubes, or better yet, the new one-half ampere, 5-volt tubes, such as the UX-112, the Daven MU-6, Cleartron 112, etc., and to push up the B battery voltage until the required power is obtained. It will be necessary to recalibrate the set owing to the changed grid-filament capacity, but the differences will be small and unless very accurate work is to be done, recalibration will not really be necessary. The audio output may be sent through an audio-frequency amplifier such as is illustrated in Fig. 2 if greater tone volume is needed.

Another method of getting greater voltages out of the radio part of the device is shown in Fig. 4, which gives the entire circuit. Currents in tuned resonant circuits are usually high, and this is particularly true when those circuits are of low resistance. Thus the output of the oscillator may be coupled to a tuned circuit and part of the voltage of that circuit used for whatever purpose is necessary, such as for measuring the resistance of coils and other radio frequency apparatus.

The oscillator is first tuned to the required frequency. Then the output circuit is tuned, and finally the circuit to be driven. Unless considerable power is required, it is not necessary to tune the output circuit which is then acting as an untuned "transmission line," and serves simply to transfer energy from one circuit to another.

Little current will flow through the transmission line, if it is untuned, but in the tuned circuit at the end there will be heavy currents.

Fig. 5 shows the apparatus required for measuring the high frequency resistance of coils. With the addition of a vacuum tube voltmeter, such as was described in RADIO

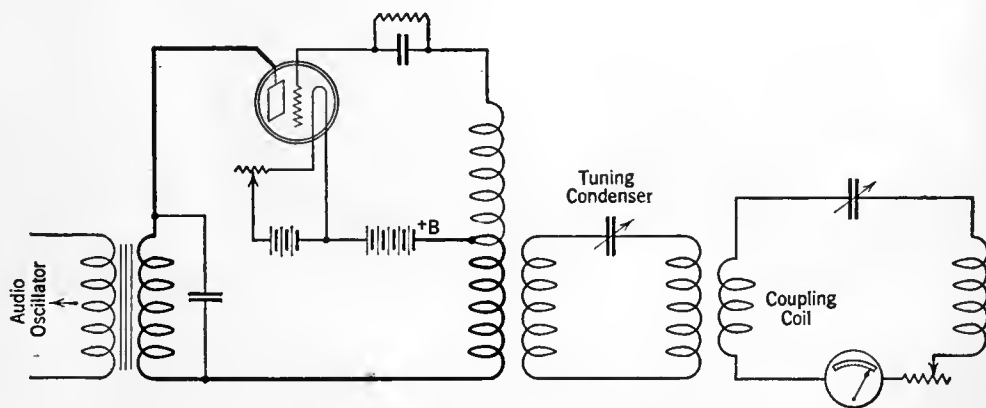

FIG. 4

A use for the radio frequency part of the oscillator. By use of a coupling coil, energy may be transferred from the oscillator to some other circuit. If this intermediate circuit is tuned by means of the condenser, much more current will flow in it and correspondingly greater voltages may be transferred to the circuit under test

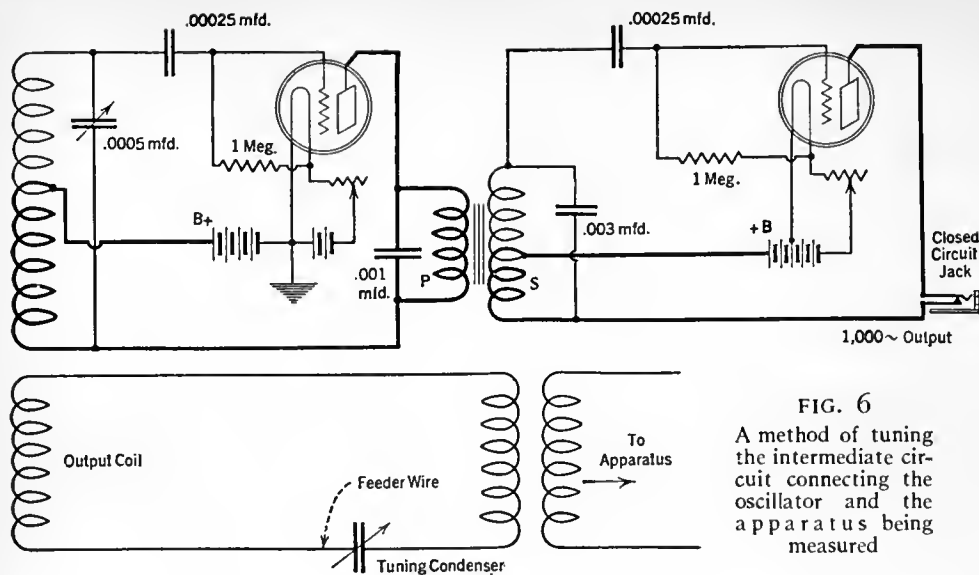

FIG. 6  
A method of tuning the intermediate circuit connecting the oscillator and the apparatus being measured

an experiment is completed. Added to the nuisance of such movement there is the likelihood that readings taken on successive days will not check—for radio frequency circuits are tricky affairs.

The tools that are needed are no more than are required for constructing receivers, but, like the electrical equipment, they should be of the best make possible. A good drill, a pair of long nose pliers, a pair of cutters, and a long, narrow screw driver are vitally necessary. Added to these may be the usual wood working tools, such as a hammer, a saw, and a plane.

Electrically speaking, the home experimenter should begin his collection of apparatus by purchasing a good voltmeter and a good milliammeter. The meters may be of the Weston 301 type installed in student bases, or corresponding meters made by Jewell, Roller-Smith, General Radio, etc. The voltmeter should have a range of 0 to 10 volts and an ammeter which will be found to have many convenient uses should read from 0 to 10 milliamperes. This will read the plate currents of 5-volt tubes under ordinary conditions, and with some simple accessory apparatus will enable the experimenter to measure the constants of tubes as well as to check up on the other experiments that go on.

Such meters can be purchased for about \$10 each with base, and are the first equipment that the experimenter should possess. Additional equipment will be cited in future articles.

RADIO BROADCAST Laboratory wishes success to prospective home laboratory owners, and will be glad to hear from readers who are interested in the experiments described here.

BROADCAST for February, 1925, page 1101, the gain of radio-frequency amplifiers may be measured.

Many experiments are now being simplified in RADIO BROADCAST Laboratory for inclusion in this series. A simple and fairly accurate impedance bridge will be described, methods of measuring the amplification of both audio- and radio-frequency transformers and the losses in coils will be explained, and among other apparatus described there will be a vacuum tube voltmeter with which many important experiments can be performed. Wherever possible references to current literature will be cited as well as to standard texts. Readers are invited to write of their experiences or difficulties or to state what particular problems they would like to see treated in this series.

WHAT SHOULD THE HOME "LAB" BE?

IT SEEMS to the writer that there are two methods by which the experimenter may carry out his work. He may have a regular place for his apparatus and for his work, or he may not. Naturally, the laboratory should be a fixed place, where apparatus may be set up and not disturbed until the experiments in progress are finished.

In this place there should be a work bench and a laboratory bench, and the latter should be kept free for the actual work at hand. It often happens that a certain set-up of apparatus will be used for some time, for instance where one is measuring the gain of radio-frequency amplifiers, and it is a waste of time and energy to tear down and set up the equipment each time

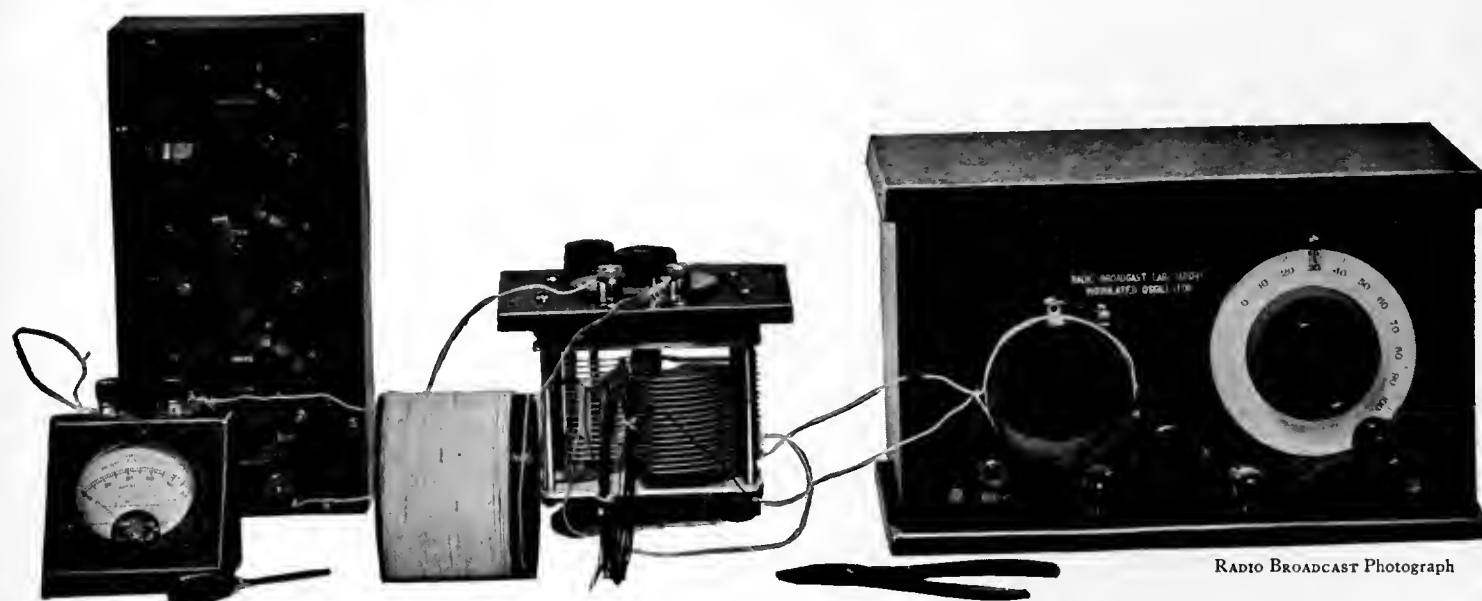

FIG. 5

A photograph of apparatus actually being used to measure the high frequency resistance of coils. The oscillator supplies the energy, a Weston galvanometer, Model 425, measures the current flowing, and a General Radio Laboratory condenser and resistance box aid in the actual measurement. In this case the intermediate coupling circuit is not tuned, consisting merely of two very small coils, one coupled to the oscillator, one to the coil under test.

Later articles will contain descriptions of simple apparatus which is capable of performing similar experiments to those described in this article

RADIO BROADCAST Photograph



**Ozarka Senior Console \$197.50** East of Rockies

*Complete with Tubes, Batteries and Speaker*



*The Sweetest Story Ever Told*



G.W. FRENCH

**If Your Radio is Bought Right  
It will be a Life-Long Pal**

**A** LITTLE more time, a little more care in making the selection in the first place generally tends to more lasting satisfaction.

Out of every 100 Ozarka's sold in 1922 only eight are not today in the hands of the original owners—this does not include 17 out of each 100 who have purchased later Ozarka models in newer type cabinets. If there is a single Ozarka that is not in active service today, we have never heard of it.

Without the Ozarka Service in charge of direct factory trained representatives, such a record would not be possible. Ozarka service can be had today in almost every country. Purchasers in South Africa, Alaska, Sweden, Newfoundland, New Zealand, and Japan all receive the same practical service as those in Canada, United States, Mexico and Cuba. Whenever you find the sign of the Ozarka long distance goose, you'll find a man who knows Ozarka instruments perfectly.

If such service added more to your cost price it might be a matter to consider, but it doesn't. Quality for quality you'll find Ozarka prices lower—four tube Ozarka's with built-in loud

speakers retail for \$58.00—five tube with built-in speaker \$64.00, up to solid walnut console design, \$160.50.

Our nearest representative will gladly set up an Ozarka in your home, without any obligation whatever. He won't tell you what it will do—he will let you do all the tuning. With the Ozarka you must satisfy yourself, as to distance, tone, volume, ease of tuning and selectivity.

More than this you will be very agreeably surprised at Ozarka prices—selling as we do, thru our own direct factory representatives, our selling expense is very low—we give Ozarka purchasers the benefit of it.

Where is there a value to compare with the one shown above—solid walnut cabinet (no walnut finish or veneer), imported English loud speaker of a marvelous tone, five tube instrument with 75 ampere Exide storage battery, 90 volts of Eveready "B" battery, 5 tubes, aerial equipment all erected and the price is only \$197.50.

**A Few More Men  
are Needed to  
Sell Ozarka**

In a great many counties we have the man we want. He is rapidly building up a permanent and profitable business of his own because he has an instrument that will more than meet all competition. More than this, he is trained to back up his sales with the kind of service that counts.

Many well established Ozarka representatives started by giving us only their spare time—their evenings. If your county is open you can do the same.

The investment in cash is very small. The investment in time necessary for study is considerable. It requires patience, but the results have enabled many men to get out of the salary and time clock class.

Any previous sales experience is helpful but not necessary. We can and will teach you how to sell.

**Send for 84 Page Book—  
"The Ozarka Plan"**



This book is entirely too expensive to be sent out on postal card requests. It will be sent FREE to any man who mails the coupon below and who is really anxious to improve his condition. Tell us about yourself—ask for Ozarka Plan No. 100 and don't fail to give the name of your county.

**OZARKA**

122 Austin Avenue B  
Chicago, Illinois



Ask the Man Who  
Wears this Button

**INCORPORATED**

122 Austin Avenue B  
Chicago, Illinois

Gentlemen: Without obligation send book "Ozarka Instruments No. 200" and name of Ozarka representative.

Name.....  
Address..... City.....  
County..... State.....

Gentlemen: I am greatly interested in the FREE book "The Ozarka Plan No. 100," whereby I can sell your radio instruments.

Name.....  
Address..... City.....  
County..... State.....

# There's Economy and Satisfaction in these Valley units

You will find both economy and satisfaction in the use of the Valley B-Eliminator and the Valley Battery Charger.

Economy in the B-Eliminator because it stops forever the expense of buying new B batteries. . .

Economy in the charger because it recharges your own storage battery at home overnight at one-tenth the cost of service station charging. . .

And satisfaction in both because, by using them, you need never miss a program on account of low or worn-out batteries.



THE VALLEY B-ELIMINATOR operates from ordinary light socket; provides a steady, noiseless flow of B current at a constant voltage all the time. With it, there can never be any decrease of signals or frying noises due to low B batteries. Volume is maintained. Reception is uniformly good. For receiving sets of from one to eight tubes. Costs less at the start than wet B batteries. Costs less in the long run than dry cells. Much more satisfactory than both.



THE VALLEY BATTERY CHARGER is the only charger needed for all radio storage batteries. Its correct 6-ampere charging rate makes overnight charging a possibility.

The Valley Charger also functions on any lamp socket. It takes about a dime's worth of current for an average charge. Quiet in operation. Most radio dealers handle the Valley B-Eliminator and Valley Charger. Any one of them will be glad to show you these units and explain their advantages.

Radio Division  
VALLEY ELECTRIC CO. St. LOUIS, U. S. A.  
Branches in Principal Cities

# Valley Electric

# "NOW, I HAVE FOUND"

A Department for the Exchange of Ideas and Suggestions of Value to the Radio Constructor and Operator

CONTRIBUTIONS to this department are welcome and those used will be paid for at the usual rates, that is from two to ten dollars each. A prize of twenty-five dollars is given for the best idea used during each three-month period. The prizewinner for the last period was announced in the November RADIO BROADCAST. All manuscripts intended for this department should not exceed about three hundred words and should be typewritten. Little consideration can be given to manuscripts not typewritten. Envelopes should be addressed to this department, RADIO BROADCAST, Garden City, New York.

## TRACING RADIO NOISES

MANY radio listeners have been led to believe that certain objectionable noises accompanying reception were caused by power-line interference, or other neighborhood operated devices, from the advice, "if the noise ceases when the antenna is disconnected, it is an indication of outdoor interference," and as such, was largely beyond the individual efforts of the set owner to control. This is not always true.

A particularly bad case of interference, which had the characteristics of outdoor interference, was discovered to be coming from the residence main switch and branch terminal cabinet, which was located fourteen feet from the receiver, in the same room.

The switch cabinet and receiver were installed on opposite sides of this room, and the lead-in wire paralleled the house wiring through the adjoining rear room at a distance of five feet, for fifteen feet, and did not enter nearer to the switch than the width of the room.

The receiver, a five-tube neutrodyne, with loud speaker, was adjusted until noises were loudest. The time selected for test was 2 a. m. when no interference was encountered from street cars, regenerative sets, or neighborhood electrical devices.

Disconnecting the antenna produced silence. Replacing the antenna and operating the room switches, the noise was still present in full volume.

Next, the residence main switch was opened, and the mystery was solved, for the noises could be produced and made to disappear by closing and opening this switch.

The continuous "crackling" or "frying" noises, similar to that produced by bad tubes, were caused by loose connection screws of the main switch, branch terminal fuse blocks, and bad contact of plug fuses.

An occasionally loud "zip," or "buzz," similar to nearby code interference, or arcing of defective receiver jacks, was caused by loose rivets fastening the main

switch blades to the switch block and was traced through applying test loads using heater coils, although arcing was not visible to the eye. Thus, all noises present at this time of day were eliminated. The remainder heard during usual broadcasting hours, such as code, sparking trolley wheels, and during heavy rain or snowfall were satisfactorily reduced to a minimum by various methods which have often been described and which will not be gone into here.

A. H. KLINGBEIL,  
Ashtabula, Ohio

## A RATCHET COIL WINDER PREVENTS UNWINDING

OFTEN in the middle of the winding of a coil, the hold will be released momentarily to straighten out the wire, and as a result the carefully arranged turns of wire may loosen, and the work has to be done over again.

A method of improving the usual winder, is shown in the sketch, Fig. 1, involving an ordinary ratchet type screw driver, which many radio experimenters have in their tool equipment. As shown, the handle of the tool is gripped in a vise, or held stationary by other means. The spindle of the winder is fixed to the barrel, and the ratchet is set so as to prevent unwinding. A ratchet type of brace bit obviously has the same advantages for this use, and the spindle is gripped in the jaws in the same manner as is the screw driver method.

The best method of restraining the wire while winding, may not be available to radio workers, for which reason the restraining reel, shown in the lower section of the sketch, will solve their problem.

Make this up of four ordinary spools, used for thread. Mount these spools on nails or screws, so that the wire will feed through with enough tension to make it tight when wound on the coil. This reel will not only restrain the wire, but will also take out kinks and make it uniform and even throughout the length of the wound coil.

G. A. LUERS,  
Washington, District of Columbia.

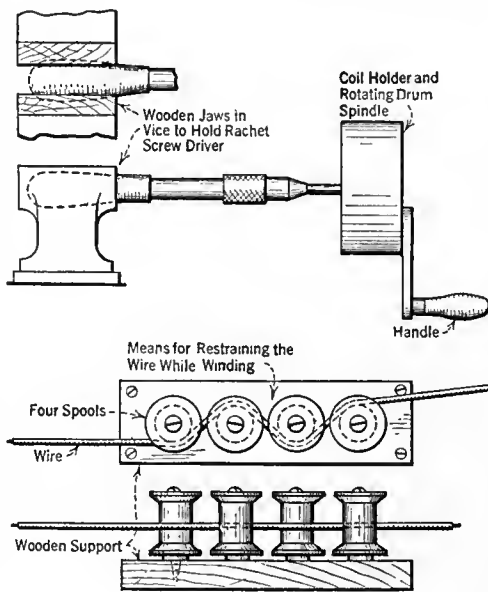

FIG. 1

*No Dials, No Panel, Built-in Loudspeaker*



Designed by R. E. Lacault, E.E., Chief Engineer of this Company, and formerly Radio Research Engineer with the French Signal Corps, Radio Research Laboratories.

To protect the public, Mr. Lacault's personal monogram seal (R.E.L.) is placed on the assembly lock bolts of all genuine ULTRADYNE Model L-3 Receivers. All Ultradyne Receivers are guaranteed as long as these seals remain unbroken.

**\$135.00**



## *The Quiet Manner and The Eloquent Tone*

UNOBTRUSIVENESS with sufficiency—the rule of good taste—is the distinguishing grace of the ULTRADYNE Model L-3 Radio Receiver. Ushers in a new era of radio reception—a new, easier command of the air's treasures.

A new artistic form of a radio receiver that blends happily with every scheme of interior decoration. Pleases the eye with its charming lines, its beautiful two-tone mahogany cabinet, its fine proportions. Has the appearance of a decorative tablepiece. Utter simplicity with superb receptive and reproductive qualities. Your local radio dealer will gladly give you a demonstration of this new modern receiver.

The Ultradyne Model L-3 is a six-tube receiver employing the fundamental principles of the best circuits greatly refined and marvelously simplified. No dials—no panel; just two inconspicuous levers, which constitute a station-selector. Volume adjustment the only other control.

*Write for descriptive folder*

# ULTRADYNE

MODEL L-3



PHENIX RADIO CORPORATION, 116-C E 25th St., N. Y.



# Carol

Far out over hill and valley —into the homes of rich and poor alike—come the waves that carry the glad tidings of the Savior's birth. Little does it matter whether the set is of new mahogany and gold or of humble cardboard coils. Tonal beauty in the amplifier is the one indispensable need for the real joy of radio. Happy indeed is the owner of Rauland-Lyric!

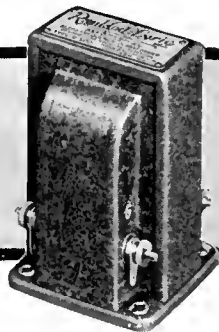

## A New Gift for Every Radio Listener

Two Rauland-Lyrics in this beautiful holiday box (fully sufficient for any radio set). See it at your dealer's!



ALL-AMERICAN RADIO CORPORATION  
4201 W. Belmont Ave., Chicago

**Rauland-Lyric**  
AN ALL-AMERICAN TRANSFORMER  
The Choice of Noted Music Critics

## A COUPLING DEVICE FOR THE ROBERTS CIRCUIT

A SIMPLE device for varying the coupling between the tickler and secondary coils is presented here for the benefit of builders of receiving sets using the Roberts circuit. This device provides a 90-degree coupling, or less, with a 180-degree turn of the dial. The rotation may be in either direction to provide the same effect, and the dial may be turned more than one revolution without altering conditions.

From Fig. 2 B, it may be seen that the

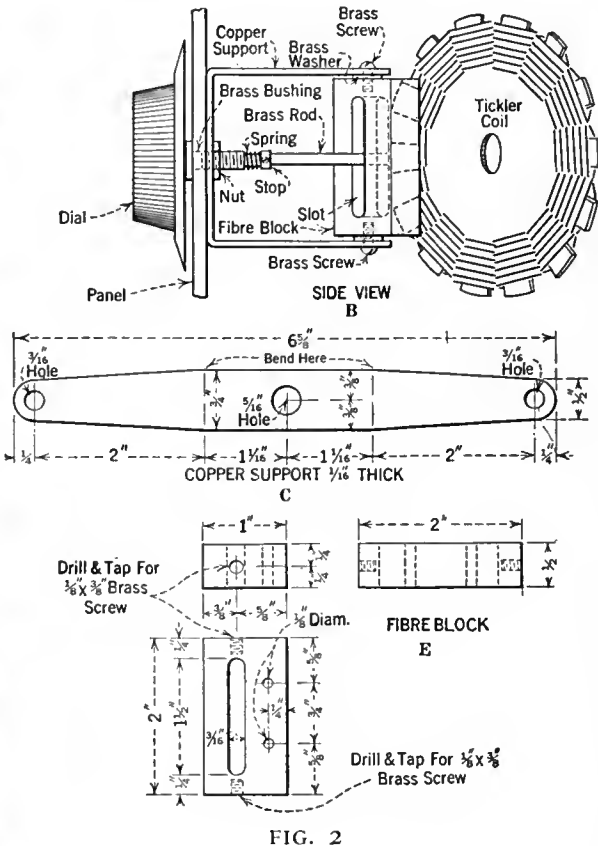

FIG. 2

whole idea of the device rests in the use of a brass rod bent as shown in Fig. 3D, and a slotted fibre block as shown in Fig. 2 E. The slot takes up all the up-and-down motion of the bent rod and makes use of the side motion as the rod is rotated. Bending the rod at an angle of less than 45 degrees will produce a coupling of less than 90 degrees. The angle of coupling will be twice the angle to which the rod is bent.

The materials used are shown in the sketches, which are self-explanatory. The same materials and dimensions need not necessarily be used however. The fibre block is shown with square corners but these may be bevelled off so that other positions of the tickler may be obtained. The center lines of the rod and block must coincide to produce smooth operation.

CLARENCE J. FRENCH,  
Wauwatosa, Wisconsin.

## A FILE FOR IDEAS

IDEAS are elusive. They come and go. Some means should be found for catching and using them. Memory is short-lived, not always

dependable, and ideas that are worth remembering are also worthy of preservation.

By having a well-organized plan for systematically preserving and storing away the best ideas constantly appearing in the pages of magazines one does not have to depend upon memory, since an idea-file will always keep them on tap, available at a moment's notice when you want them. The necessity of having to remember where you last saw such and such an idea, and having to spend a lot of unnecessary time trying to dig it up is obviated by the use of a good file.

The idea-finder saves you this annoyance and bother. It also saves time and labor, for if you have filed away your material for safe keeping, it is always going to be on hand, right at your finger tips, ready for instant use.

Good ideas are always finding their way into print. Plans are being constantly evolved by others and heralded in the pages of magazines. There is always a wealth of various kinds of information at hand, simply awaiting collection, coordination, and preservation in organized form.

By starting such an idea-storehouse you can have within elbow reach the most useful data that can be obtained from literature of all kinds—data which might otherwise, for want of assimilation and organization, go to seed, be forgotten or neglected.

As you read a magazine you can mark articles of particular interest which suggest fruitful ideas for future application, and index them in synopsis form on a 3 x 5 inch card, which is filed in a card tray, with alphabetic guide cards. These are arranged according to subjects in which you are vitally interested.

Then again, you can clip these articles and file them away, either in filing folders, or in a desk-book file, with pocket pages, an old time bill file, or a work-organizer. Any of these simple accessories may be obtained from a local stationery store at small cost.

If you want to put your own ideas to work immediately, you scrimp-age through your file and find data already in your idea-storehouse which enables you to carry out your own plans effectively, and with greater assurance of success. Or, your own ideas may start you on a scouting expedition for similar plans in the magazines to which you regularly subscribe, and so open up a new subject for further investigation and data-gathering.

F. E. KUNKEL,  
Washington, D. C.

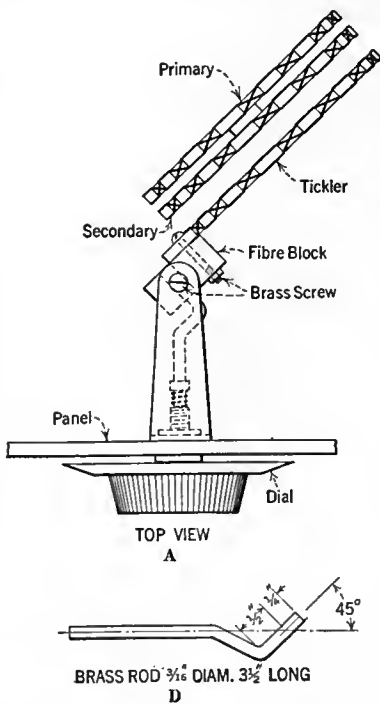

FIG. 3

# The World Expected a Supreme Radio Set from **KELLOGG** *and here it is!*



## A Separate Circuit for Each 40 Meter Wavelength Band!

*Kellogg* — for 28 years makers of precision telephone instruments and equipment — producers of quality parts since radio began — Kellogg has perfected a radio receiver worthy to bear the Kellogg name.

In the illustration we visualize this wonderful engineering achievement.

In the new WAVE-MASTER there are nine separate circuits — one for each 40 meter wavelength band. Each circuit gives that maximum efficiency heretofore found only in one short section of the dials of ordinary radio frequency sets. Each circuit brings within the range of the tuning dial a different group of stations.

How wonderfully simple tuning becomes! Merely set the pointer to the wave zone in which you are interested and bring in the desired station with the single Selector dial.

This remarkable tuning dial actually has a tuning range of 540 de-

grees — equal to 1½ times around a complete circle — over three times the station finding range of any other set.

All other radio frequency sets have variable capacity which must be tuned, usually with three different dials, to balance with their inductance coils.

The WAVE-MASTER'S inductance is not fixed but variable and is easily and quickly tuned, with the one Station Selector dial, to balance the fixed capacities.

Write us for the name of your nearest dealer. We will also send on request, a complete explanation of the WAVE-MASTER circuit. Ask for Folder No. 5-L.

Kellogg Switchboard & Supply Company  
1042 W. Adams St., Chicago, Ill.

**KELLOGG**  
**WAVE MASTER**  
SWITCHBOARD & SUPPLY CO.

**WAVE-MASTER**  
Standard Model  
\$125.00



**WAVE-MASTER**  
Brown Walnut Console  
with inbuilt horn  
\$275.00

### Radio Dealers and Jobbers

The WAVE-MASTER franchise, backed by Kellogg resources and our powerful advertising campaign, is most valuable. Open territory is being closed rapidly. Wire us, or get into Chicago, quick, and see us.



Radion Panels in black and Mahogany come cut in standard sizes for all sets.

## Be Sure of Lowest Losses

**R**ADION Panels are most effective in reducing surface leakage and leakage noises because they are moulded from the insulating material *made to order for radio purposes exclusively.*

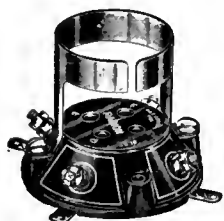

No. 2 Socket for new UX tubes with collar adapter for old type tubes. No. 4 same as No. 2, without collars, for new UX tubes exclusively.

Tests after tests have proved that Radion insures lowest losses and highest efficiency. Radion Sockets, Dials, Insulators and Tubing have the same high-resistant characteristics as Radion Panels. They embody the latest developments in radio. Ask your dealer to show you the complete line of Radion low-loss parts.

Send 10 cents for booklet, "Building Your Own Set"

AMERICAN HARD RUBBER COMPANY  
Dept. C-12 11 Mercer Street New York City  
Chicago Office: Conway Building  
Pacific Coast Agent: Goodyear Rubber Co.  
San Francisco Portland



New No. 10 4-inch Radion Dial. Nine other styles in several sizes to meet all requirements.

# RADION

The Supreme Insulation

Made to order for radio purposes exclusively

AMERICAN HARD RUBBER CO.  
Dept. C12, 11 Mercer St.  
New York City

Please send me your booklet for which I enclose 10 cents in stamps.

Name .....

Address .....

.....

### SUPER-HETERODYNE NOISES

I HAVE been troubled at times with a peculiar sort of throbbing, spluttering noise which was sometimes accompanied by a low whine which sounded as if it was under a strain, on my super-heterodyne.

I tried almost everything to obviate this trouble and inquired of several radio men as to the cause—without result, and was almost baffled. I finally discovered that it was due to corroded A and B battery terminals.

I used battery clips to connect to the battery and when the clips all happened to bite through the corrosion I did not get the noise. "How simple!" the reader will probably say, but I will confess that it bothered me at times for two months before I finally ran it down.

I hope that this may be of benefit to some other fan.

I. T. SUGGS,  
St. Paul, Minnesota.

### CHECKING UP ON B BATTERY LEAKAGE

**M**ANY magazines are advising the use of incandescent lamps in series with the B battery to protect tube filaments, and to lengthen the life of such batteries, by lighting up to indicate shorts.

When such a lamp is used with a multi-

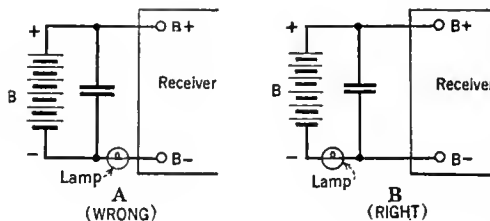

FIG. 4

tube set having no by-pass condenser, or else a very small one, oscillations and howling often result. The effect is the same as using a B battery partly run down—it adds resistance to the circuit. Therefore put a large condenser directly across the B battery as shown in Fig. 4 B.

If the lamp lights dimly when the set is turned on, of course a short circuit exists in the set and can usually be easily located. But the fact that the lamp does not light is no indication there is no B battery leakage in the set—a small leak wouldn't pass sufficient current to light the lamp. So it is advisable, before any home-made set is put in use, and after making tests for shorts and remedying any found (a short would ruin the meter in the next test), to connect a high resistance voltmeter in place of the lamp in B. Turn up the rheostats, when a small deflection on the meter should result. Then turn the rheostats completely off and the meter should read zero. If it reads even slightly past zero, there is a leak in the set which will run the B batteries down even when the set is not in use.

For example, one set checked this way showed a very small deflection, which, measured with a milliammeter, amounted to only 1/2 milliamperes. The set required seven milliamperes in operation, but because such a leak goes on whether the set is in use or not, this one would cut the B battery life in half where average use of the set was one

and a half hours per day. The trouble in this particular set was traced to a by-pass condenser of .002 mfd. size (of reliable make, probably damaged by soldering), and replacing it stopped the leakage. Another leak of this sort was located between the windings of one long-wave transformer in a super-heterodyne outfit.

The measurement by a milliammeter was not necessary to locate the leakage, it was made merely to show by calculations how serious such troubles might be. Where the B battery life is short in any set, the above test is certainly advisable.

CLAUDE SCHUDER,  
Sumner, Illinois

### A VARIOMETER TO TUNE ANTENNA CIRCUIT OF THE ROBERTS SET

**A**VARIOMETER can be used to replace the two antenna coils, variable condenser, and switch, in the Roberts circuit. It is much simpler to construct than the standard arrangement, is easier to tune, just as selective, takes up less space, and makes a neat panel appearance, and there are fewer possibilities of losses. If you are mechanically inclined, you can easily make a variometer.

The sketch, Fig. 5, shows the part of the set that is changed. From the grid of the amplifying tube and the plus terminal of the C battery, the hookup is the same as in the original circuit diagram. Connect the stator terminal to the antenna binding post. The rotor goes to the ground post. Some variometers may work better with the rotor terminal connected to the antenna post and stator to the ground. Connect the terminal of the variometer that is connected to the antenna, to the grid terminal of the amplifier tube as shown. Connect the ground terminal of variometer to the negative post on the C battery. A small fixed condenser of about .00025 mfd. will probably be needed in series with the antenna as shown, otherwise the average variometer will not reach below 999 kilocycles (300 meters) when used this way, especially if you have a long antenna. It is interesting to experiment with a variable condenser in series with the antenna.

There have been many interesting suggestions on improving the Roberts set and

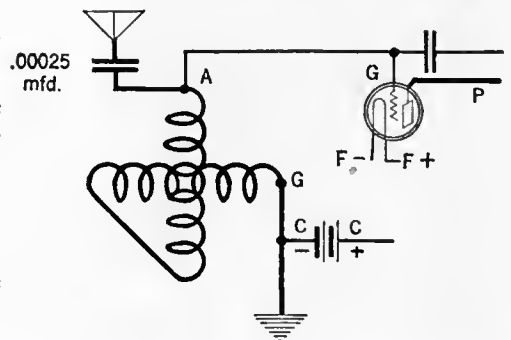

FIG. 5

the variometer will work equally well with two or four tubes. A set in Washington, District of Columbia, using four dry cell tubes, gave good loud speaker volume on KHJ. With two tubes, KHJ was easily heard on head phones. I logged seventy-five stations on a loud speaker in one month.

JOHN L. LEE,  
Washington, District of Columbia.

**EVEREADY HOUR**  
**EVERY TUESDAY AT 9 P. M.**  
*Eastern Standard Time*

For real radio enjoyment, tune in the "Eveready Group," broadcast through stations —

<b>WEAF</b> New York	<b>WCAE</b> Pittsburgh
<b>WJAR</b> Providence	<b>WSAI</b> Cincinnati
<b>WEEI</b> Boston	<b>WWJ</b> Detroit
<b>WTAG</b> Worcester	<b>WCCO</b> Minneapolis
<b>WFI</b> Philadelphia	<b>WOC</b> St. Paul
<b>WGR</b> Buffalo	<b>WOC</b> Davenport

**KSO** St. Louis

## For radio economy

EVEREADY Radio Batteries are noted for their long service and economical operation. They are made in different sizes and types so that every radio user can enjoy the economy and convenience to be had by fitting exactly the right Eveready to his receiver. The five dry cell types of Eveready Radio Batteries are here illustrated and described to make it easy for you to decide just which will give the longest and most economical service on your set. A dealer near you sells Evereadys.

*Eveready Heavy-duty "B" Battery for four or more tubes*

No. 486. *Extra-large Layerbilt*. 45 volts. Vertical. Eveready's latest contribution to radio. The new Layerbilt construction which gives much greater service. Same size as No. 770. Price \$5.50.

*Eveready "B" Battery for one to three tube sets*

No. 779. *Large*. 22½ volts. Vertical. Especially adapted for Radiola 25, DeForest D-17 and Operadio receivers. Same capacity as No. 766, and suitable wherever variable taps are not required. Price \$2.00.

*Eveready "B" Battery for portable sets*

No. 764. *Portable*. 22½ volts. Vertical. For portable sets where medium weight and size are permissible. Price \$1.75.

*Eveready "A" Battery*

Eveready Columbia Ignitor Dry Cell Radio "A" Battery for all dry-cell tubes. 1½ volts. The dry battery used by vacuum-tube engineers in developing the dry-cell tube.

*Eveready "C" Battery*

No. 771. 4½ volts. Saves "B" Batteries, improves tone. Price 60 cents.

*Manufactured and guaranteed by*

**NATIONAL CARBON COMPANY, Inc.**

New York

San Francisco

Canadian National Carbon Co., Limited, Toronto, Ontario

# EVEREADY

## Radio Batteries

*—they last longer*

No. 764  
 Portable  
 22½-volt  
 Vertical  
 Price  
 \$1.75



Eveready  
 Columbia  
 Ignitor  
 "A"  
 Battery,  
 the proven  
 dry cell  
 for all  
 radio  
 dry cell  
 tubes  
 1½ volts

No. 779  
 Large  
 22½-volt  
 Vertical  
 Price  
 \$2.00

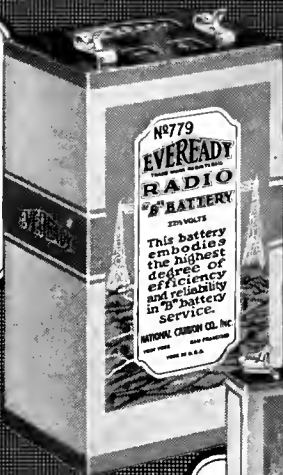

No. 771  
 4½-volt  
 "C"  
 Battery  
 Price  
 60 cents



No. 486  
 45-volt  
 Layerbilt  
 Extra-  
 large  
 Vertical  
 Price  
 \$5.50



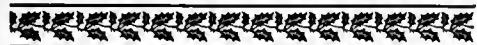

*for Christmas*  
**A set of NA-ALD**  
*Colored Dials*  
*to dress up your radio*

*Give 'em to your wife and  
 get the benefit yourself!*



**WHEN** fans first built radio sets, the womenfolk registered silent objection to their ugly appearance but they endured the clutter because radio was such a novelty and because they thought maybe you'd soon get over the craze.

But soon as they saw your craze was a permanent obsession, they began asking for better-looking sets.

The latest, up-to-the-minute advancement in making a set harmonize with its surroundings is represented by the New Alden Colored Dials. They will make your old set most attractive. To the new set they will add the pleasing qualities of color and beauty.

The colors are Garnet; Malachite Green, like mottled green and white marble; Brilliant Tortoise, that blends with every color combination; or in beautiful Grained Mahogany. \$5.00 a set, any color, in hardware, electrical, radio or department stores and in gift shops.

Give a set to someone in your family and then—all of you can enjoy their beauty! Or here's a stunt. Leave this magazine open on the living room table at this page, with a big pencil check mark beside this ad, and see if the family doesn't take the hint and buy a set for you. If the wife of one of your radio fan friends asks you what to give her husband for Christmas, you might mention Alden Colored Dials.

Mail the coupon below if you'd like some free but worthwhile information on the New Colored Dials.

**ALDEN MFG. CO.**  
 Dept. B13. Springfield, Mass.

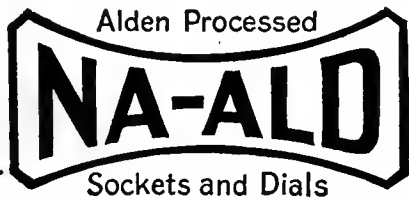

**ALDEN MFG. CO.**  
 Springfield, Mass. Dept. B13.

*Please send me "What to Build" information together with information on Na-Ald Colored Dials.*

Name .....  
 Street .....  
 City ..... State .....

# HOW TO ELIMINATE LOCAL INTERFERENCE

## Part 2

### Some Practical Information Based on the Results of an Investigation on Radio Inductive Interference

*L*AST month's RADIO BROADCAST presented the first of two articles to be printed herein on the above subject. The information has been taken from a very excellent little pamphlet which has been specially prepared by the Radio Branch of the Department of Marine and Fisheries of the Dominion of Canada Government, and which is entitled "Radio Inductive Interference, Bulletin Number One." The previous article was devoted chiefly to determining the source of various forms of interference while this concluding part gives much practical information for the elimination of the trouble once it has been found.



#### MEANS OF SUPPRESSING RADIO INDUCTIVE INTERFERENCE

**I**N CASES where electrical apparatus suspected of causing interference appears to be in good mechanical and electrical condition, it is very often possible to supply some means of preventing electrical surges, originating in the apparatus, from getting out to the power line where they would radiate and cause radio interference.

These electrical surges have the property of passing through condensers more readily than through inductances. The method employed, therefore, in preventing electrical surges from traveling along the power lines and thus causing radio interference, is to provide a path to ground

sufficient insulation to withstand the voltage of the line. These installations should be approved by the local electrical inspector to ensure that there are no fire or accident hazards introduced by the installation.

It is important in the design of these choke coils that they should have low distributed capacity in order to prevent the electrical surge passing through the choke coil by means of this capacity.

#### CHOKO COIL

**A**TYPE of choke coil recommended for cases where the current is less than three amperes, is constructed according to Fig. 1. It consists of a hundred turns of No. 18 double cotton-covered copper wire in a single layer, wound on a fiber tube 3 inches in diameter, 1/8 inch thick. Leads are soldered to each end and made from No. 14 flexible rubber-insulated braid-covered copper wire, making one turn around the tube then through a hole in the tube and extending through the inside of the tube. The burrs are carefully removed from the hole in the fiber tube so as not to cut the insulation. End rings or fillers are mounted at the end of the winding to build up the same diameter as the outside diameter

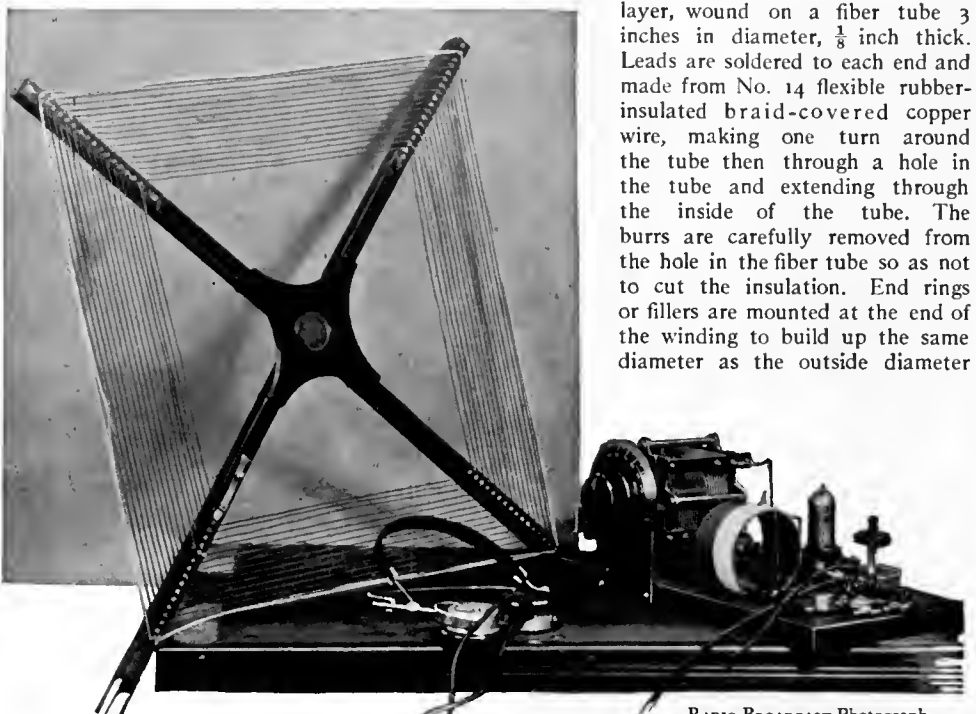

RADIO BROADCAST Photograph

#### AN INTERFERENCE FINDER

Of typical form. This was made in the RADIO BROADCAST Laboratory. One Duplex variable condenser tunes both loop and the R. F. secondary, which feeds into a crystal detector

in the form of a condenser to filter or drain off this surge. In order to make this filter more effective, it is often advisable to introduce between the line and the source of the disturbance a trap, which will make the passage of the surge more difficult. This trap preferably takes the form of a choke coil which consists of a number of turns of wire of sufficient size to carry the required current without overheating, and

of the winding. These may be made of tape or a suitable size of fiber tube. The whole coil is then covered with five layers of Empire cloth and then taped with black friction tape and painted with insulating varnish. Mounting lugs made of fiber are then attached to each end of the coil.

This coil should be mounted on a board covered with asbestos 1/8 inch thick and the leads



# ATWATER KENT RADIO

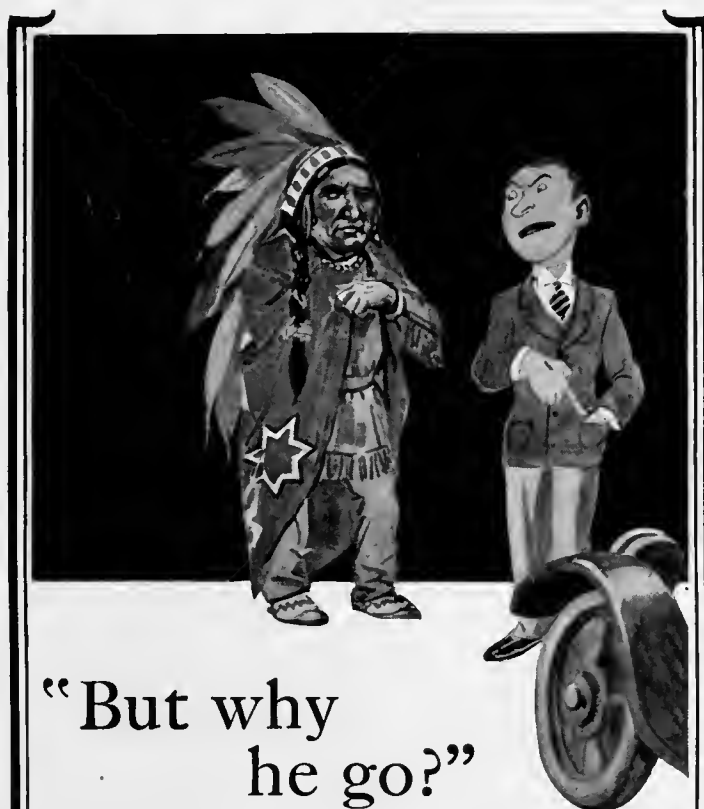

“But why  
he go?”

WHEN they struck oil on the Indian lands in Oklahoma many of the Indians became suddenly rich. One of them, anxious to begin his life of luxury, went to buy an automobile.

The salesman launched into a description of the car in detail. Technical term followed technical term in a bewildering stream. Finally the salesman thought his work was done. He produced an order blank and paused.

“Now,” he asked, “is there anything else I can tell you?” The Indian scratched his head.

“Um,” he said. “You tell me: He no have horse. Why he go?”

We could give you a description of the Atwater Kent Radio Receiving Sets and Speakers that would fill hundreds of pages.

But what would be the use? You would still judge an Atwater Kent, as you should, by its performance. We want you to judge it that way, to compare it with any other radio you are considering.

By looking at it and listening to it, you will get some of its technical perfection. When you have owned it and lived with it, you will know how good it is.

Hear the Atwater Kent Radio Artists every Sunday evening at 9.15 o'clock (Eastern Standard Time) through stations:

WEAF . . . New York	WEEI . . . Boston	WCAE . . . Pittsburgh
WFI } Philadelphia	WGR . . . Buffalo	WOC . . . Davenport
WOO } alternating	WWJ . . . Detroit	WSAI . . . Cincinnati
WJAR . . . Providence	KSD . . . St. Louis	WTAG . . . Worcester
WCAP . . . Washington	WCCO . . . Minneapolis-St. Paul	

Write for illustrated booklet of Atwater Kent Radio

ATWATER KENT MANUFACTURING COMPANY  
A. Atwater Kent, President  
4726 WISSAHICKON AVENUE PHILADELPHIA, PA.



Model R, \$12



Model L, \$17



Model H, \$22



Model M, \$28



Model 12 (without tubes), \$100



Model 10 (without tubes), \$80

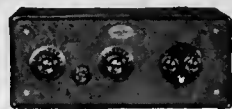

Model 19, \$60

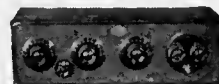

Model 20 Compact, \$80

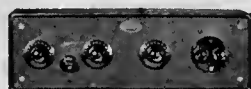

Model 20, \$80



Model 24, \$100

Prices slightly higher from the Rockies west, and in Canada

Prices slightly higher from the Rockies west, and in Canada



Patented Nov. 18, 1924

Windsor Loudspeaker Console

## For EVERY Radio Set

A stunning piece of furniture that restores order in the room where you have your Radio! No more cluttered table-tops, nor litter of equipment under-foot.



Non-Vibrant Ceramic Horn

No unsightly horn in evidence, either! This console has its own loudspeaker, in-built. It's out of sight, but with very apparent tonal superiorities. For it has the highest-developed type of unit. With horn built of special non-vibrating, extra-hard, ceramic material. Produces clear non-vibrant tone.

The clearest tone producer on the market. Made of special composition which defeats vibration.

There's ample room for everything; space for largest A and B wet batteries—or battery eliminator—required for any home set; and for a big charging outfit, too.

Finished in mahogany, or walnut color. Dainty design of parqueterie on two front panels. Top, 38 in. x 18 in. Substantially built; the product of a 40-year-old furniture maker.

The price, forty dollars, is for the complete console and includes the loudspeaker horn and unit. Thousands of dealers are showing this artistic addition to home radio equipment.

★ Rear View—Set Hooked Up



Price, \$40  
West of Rocky Mts., \$42.50

Windsor Furniture Co.  
1420 Carroll Ave.  
Chicago, Ill.

soldered and thoroughly taped according to standard wiring practice. Another type of choke coil which will be found eminently satisfactory for use in motor lines, telephone bell-ringing lines, etc., is that described on page 438



RADIO BROADCAST Photograph

### A PORTABLE INTERFERENCE FINDER

Consisting of a stage of radio frequency amplification followed by a crystal detector. A collapsible loop will greatly improve the portability possibilities

### INSTRUCTIONS FOR MOUNTING CONDENSERS

CONDENSERS which will stand a test voltage of 1000 volts d. c. may be connected across an alternating current or direct current circuit of 250 volts or less. On circuits which are protected by fuses of not more than 15 amperes capacity, no additional fuse is required for the condenser. On circuits protected by fuses of greater than 15 amperes capacity, a separated cutout base and small fuse (of approved type) not exceeding 15 amperes, must be installed between the condenser and each ungrounded power wire. Where condensers are not installed in metal boxes and are to be placed on wooden surfaces, they should be mounted on pads of asbestos at least  $\frac{1}{8}$  inch thick, and these pads should be sufficiently large to extend beyond the clamps used for holding the condenser in place.

Where condensers are to be used on 550 volt circuits, two condensers of the approved type must be connected in series between the lines and the common point may be grounded. In such installations, the condensers are to be protected by 600-volt fuses not greater than 10 amperes in each live line, and both the condensers and fuses are to be enclosed in a grounded metal case. Where the condensers are to be connected to two-phase or three-phase circuits not greater than 600 volts, one condenser may be connected from each live line to ground and installed with fuses in boxes as stated above.

As these condensers contain wax, they should not be placed where they may be subjected to excessive heat.

Condensers when connected to a circuit as stated above have no objectionable effect on the circuit or the operation of any electrical apparatus and they do not consume any power.

### APPROVED TYPES OF CONDENSERS

THERE are now many condensers on the market suitable for the purposes detailed in this article. Those chosen must be capable of standing a test voltage of 1000 volts d. c. At

the time of the publication of this bulletin by the Department of Marine and Fisheries of the Dominion of Canada Government, special condensers having No. 14 rubber-insulated leads suitable for installing without metal boxes, were obtainable from the Radio Branch of the above Department, at cost.

### TREATMENT OF TYPICAL CASES

IN MANY cases it is possible to make slight changes in the connections of the electrical apparatus causing the surge in order to use some existing apparatus as a choke coil and thus prevent the necessity of adding additional choke coils to the system.

A series commutator motor causing a surge by sparking at the brushes may have its leads reversed to reduce the radio interference. Where one wire is grounded, radio interference from such a motor is sometimes reduced by reversing the leads supplying the motor, so that one of the brushes is connected to the ground side of the line and the field coil is connected to the live side of the line. In this case, the field coil is used as a choke. It may also be necessary to place a

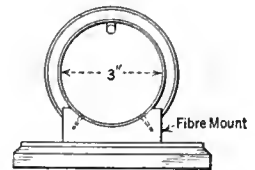
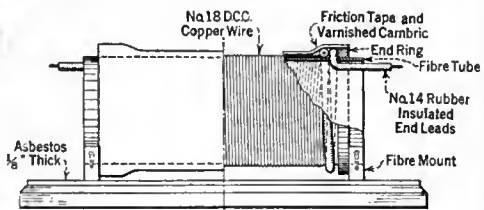

FIG. 1

Details for the choke construction. It consists of one hundred turns of No. 18 d. c. c. copper wire on a three-inch tube

condenser of one or two microfarads capacity across the brushes. This is shown in Fig. 3.

In cases where neither side of the line is grounded, a choke may be inserted on the line connected directly to one of the brushes, while the field coil may act as a choke in the other line. In this case it is recommended to use two 2-microfarad condensers in series and ground the middle point according to the diagram.

In cases where it is not convenient to make connections with the brushes of a motor, the condenser may be placed across the line as near the motor as possible, and a choke coil may be

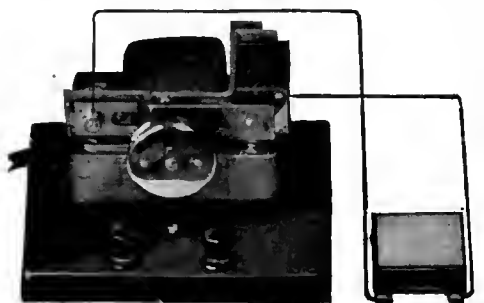

RADIO BROADCAST Photograph

FIG. 2

Showing condenser connection across vibrating contacts of a battery charger

inserted in the live line when necessary. See the instructions above regarding approved condensers and the use of fuses.

# The S. L. F. that doesn't "hog" panel space

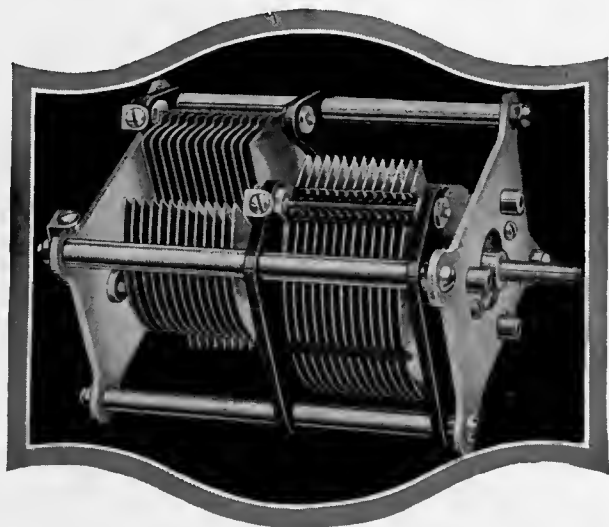

The principal objection to many Straight line Frequency condensers now on the market is that they "hog" too much panel space; thus making it necessary to re-arrange other instruments on the panel or rebuild the set entirely to allow enough room for the scythe-like sweep of the S. L. F. rotor.

The new General Radio type 374 S. L. F. condensers eliminate entirely all such difficulties. They occupy the same panel space as the well known types 247 and 334 condensers—and no more. In fact they may be used interchangeably with those condensers since the mounting holes are the same.

By using smaller rotor plates of correct shape and double the number of plates General Radio condensers have a straightline frequency calibration curve without the mechanical disadvantages encountered in the average S. L. F. with fewer plates of larger area. The assembly of the type 374 condensers with respect to bearings, soldered-plates, and correct spacings are the same as the types 247 and 334.

For further description and prices ask to see them at your local dealer's or write for our latest Bulletin 923-R.

## GENERAL RADIO COMPANY

30 State St.

Cambridge, Mass.

For over a decade General Radio parts have been the universal standards of quality.

They have been developed by the same engineers who designed the precision apparatus now used as standard equipment in nearly all the leading commercial and technical school laboratories throughout the entire world.

Since 1915 the General Radio Company has supplied scientific instruments in ever increasing quantities to such prominent institutions as the General Electric Company, Westinghouse, Bell Telephone System, and the Bureau of Standards for use in electrical and radio research.

No one company in the history of radio has contributed more in laboratory equipment than the General Radio Company.

The same outstanding skill, materials, and workmanship are embodied in General Radio parts for use in the construction of broadcast receivers.

Through the merits of design, performance, and price General Radio instruments for the scientist or set-builder are universally recognized as the Standards of Excellence.

Every instrument made by the General Radio Company is thoroughly guaranteed.



# GENERAL RADIO

*"Behind the panels of Better Built Sets"*

# Christmas On the Air!

## Are Your Tubes in Shape?

At Christmas Tides! Listen to sweeter "Christmas Carols"—clearer chimes and more celestial music broadcast by the great cathedral choirs throughout the land.

### A Rhamstine★ TUBE BOOSTER

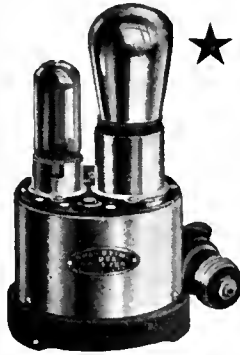

★ will renew your old tubes with all the pep and freshness of new ones. Just put them in the socket and turn on the current—do it once a month—it will treble the life of your tubes and give you better distance, volume, and a tone as clear as a bell at all times. It will pay for itself in a few days.

Works on any alternating current 110-120 volts, 50-133 cycles. It matters not, whether you use 201-A or 199 Type Tubes.

Send no money—check the coupon below—pay on delivery.

Rhamstine★  
Tube Booster

Only \$6

### "B" Rectifier Eliminates "B" Battery



Rhamstine★ "B" Rectifier

Only \$25

(Tube not included)

Eliminates all your "B" Battery troubles such as recharging, dead cells, and chemical action. A Rhamstine "B" Rectifier will more than take the place of a "B" Battery—it will give a continuous and uniform current year in and year out with absolutely no trouble at all. Small, compact, good looking, endorsed by the leading radio manufacturers, and reasonably priced. You should have one.

Send no money—just check the coupon.

Tube Boosters are Trade Boosters.

DEALERS write for our attractive proposition.

#### Mail the Coupon To-day

J. THOS. RHAMSTINE★ (12)  
506 E. Woodbridge, Detroit, Mich.

Please send me

Rhamstine★ Tube Booster at \$6  
 Rhamstine★ "B" Rectifier at \$25  
by express C. O. D. subject to inspection. If I am not entirely satisfied with the "B" Rectifier I will return it to you in five days and receive a refund of the full purchase price.

Name.....

Address.....

J. THOS. RHAMSTINE★

Radio and Electrical Products

506 E. Woodbridge St., Detroit, Mich.

The live side of a low voltage lighting circuit may be determined by means of a test lamp connected from ground first to one wire and then to the other. The lamp will light when connected from the live line to ground.

Battery charger of the vibrator type may be prevented from causing radio interference by connecting a condenser of 1/2 microfarad capacity across the vibrating contacts. This is illustrated in Fig. 2 on the previous page. In the case of battery chargers it is useless to put condensers

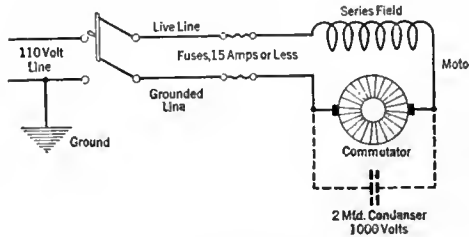

FIG. 3

Method of connecting a large capacity condenser across the brushes of a small motor

across the mains, as it is necessary to make use of the choke consisting of the wire and coil within the battery charger, to prevent this surge from getting out on the line.

Flashing electric signs may usually be prevented from causing radio interference by connecting condensers of from 1/2 to 2 microfarads capacity across the contacts of the circuit breaker. It is sometimes necessary, however, to add a choke coil at the line side of the circuit breaker and also connect the condenser across the contacts of the circuit breaker. As the radio interference from such sources depends upon the conditions of the installation it is necessary to make these few experiments, as suggested above, in each case in order to reduce the radio interference most effectively.

Sometimes the radio interference from a flashing sign installation is caused by sparking at the commutator of the motor which drives the flasher. This may readily be determined by the nature of the sound in the radio receiver and may be remedied by the method described for dealing with interference from commutator motors.

Internal combustion engine ignition systems may cause radio interference, but this is usually of a very local nature. Such interference may be considerably reduced by making the leads from the magneto or spark coil to the engine as short as possible and running them in a grounded shield, such as metal conduit or lead-covered cable. The frame of the engine, magneto, and all shields, should be thoroughly grounded.

Rotary converters sometimes cause radio inductive interference by producing a surge which travels out both on the alternating and direct current lines. In some such cases it may be necessary to introduce choke coils into the alternating current lines and put condensers across the lines between the choke coils and the converter. Before putting these choke coils in the alternating current lines, it is recommended to try the effect of condensers across the brushes as described previously for the case of commutator motors.

Electric ozonators which are used for purifying the air in large buildings and for bleaching purposes in flour mills, sometimes cause radio inductive interference by producing a surge which travels along the primary lines supplying the ozonator.

This interference may easily be eliminated by connecting two choke coils of the cylindrical type previously described, one in each of the low voltage lines placed as near as possible to the ozonator.

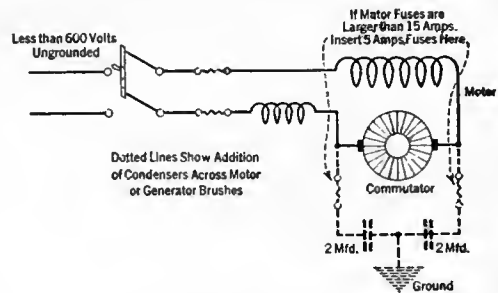

FIG. 4

Connection for two condensers in series across the brushes of a motor generator. The position for extra fuses, if the motor fuses are larger than 15 amps., is clearly shown

## A List of Australian Broadcasting Stations

Here is a complete list of Australian broadcasting stations now active in that country. It is not generally known that one of these stations, that at Brisbane, Queensland, can vie with some of the important American stations as far as power is concerned, for they use 5000 watts. As will be seen by the list, three of the seven other stations use as much as 3000 watts. American stations are often heard in Australia, especially those situated on the Pacific Coast. We are indebted to Mr. A. W. Watt, editor of Australian Wireless Weekly, for the appended list.

LOCATION	OWNER	CALL SIGNAL	FREQUENCY IN KC.	WAVELENGTH IN METERS	POWER IN WATTS
Sydney, New South Wales	Farmer and Company Ltd.	2FC	261	1150	3000
Sydney, New South Wales	Broadcasters, Ltd.	2BL	857	350	500
Melbourne, Victoria	Australian Broadcasting Co. Ltd.	3LO	809	371	3000
Melbourne, Victoria	Associated Radio Co., Ltd.	3AR	789	380	500
Adelaide, South Australia	Central Broadcasters Ltd.	5CL	937	320	500
Perth, West Australia	West Australian Farmers Ltd.	6WF	240	1250	3000
Hobart, Tasmania	Associated Radio Co., Ltd.	7ZL	769	390	500
Brisbane, Queensland	Government Radio Service	4QG	779	385	5000

The broadcasting from the above stations is usually divided into four sessions, morning, afternoon, early evening, and evening. The exact times of these sessions, taking 30 as an example, are as follows: Morning, from 11 a. m. to 2 p. m.; afternoon, from 3 p. m. to 5.15 p. m.; early evening, from 6 to 7.15 p. m.; evening, from 7.15 to 11 p. m., the program always concluding with "God Save the King." The difference between New York and Melbourne time is fifteen hours, thus, when it is midday in New York on a Monday, it is 3 a. m. Tuesday in Melbourne. Appropriate allowances must be made when comparison is being made between Melbourne time and United States time in points west of New York, and also for Australian points west of Melbourne.

THE · PERFECT · UNION · OF · ART · AND · SCIENCE

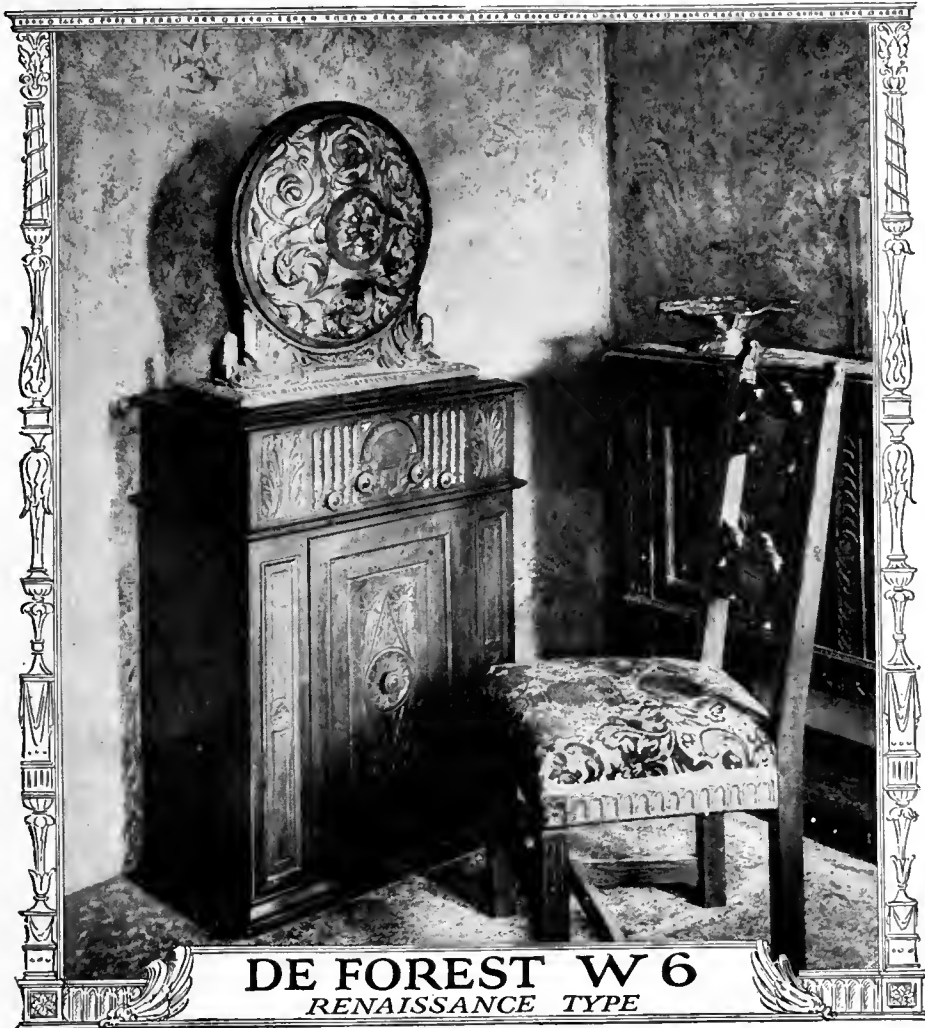

**DE FOREST W 6**  
RENAISSANCE TYPE



**DE FOREST AUDION**

is the world standard in tubes. De Forest created the first successful radio tube, and his invention made broadcasting possible. The De Forest policy of a specific type tube for each socket insures finer reception and greater distance. Price, \$3.



**DE FOREST F-5 AW**

A compact, powerful set in polished walnut that will bring joy to many a household. Gives rich volume, and has the capacity to separate stations positively so that you can pick the broadcast gems without interference. Extremely easy to operate. Price (minus tubes, loud speaker and batteries) \$90.

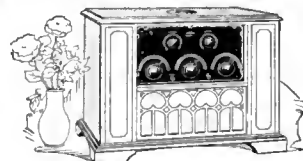

**DE FOREST F-5 M**

A superfine 5-tube set in two color mahogany cabinet with built-in loud speaker and concealed compartments for "A" and "B" batteries. A great distance-getter, with uncanny power to tune in and out stations at will, and gifted with splendid tonal qualities. Extremely simple to operate. No howling or hissing in tuning in. An unsurpassed value at \$110.

De Forest Radio Sets can be bought at prices ranging from \$85 to \$450.

# De Forest Genius now Humanizes Radio!

MARVELOUS new circuit, just perfected, reproduces flawlessly the mellow, soft modulations of the human voice and captures the hitherto elusive overtones of the musical register . . . tuning simplified . . . a new ease in operation . . . all embodied in the new and beautiful De Forest W5 or W6 Radiophones.

The voice of radio is no longer flinty and metallic, but mellow, human and musical—thanks to the development by Roy A. Weagant, Vice-President and Chief Engineer of the De Forest Radio Company, of a new and marvelous circuit.

This ingenious circuit, and all the joy it means to radio lovers, makes its first public appearance in the De Forest W5 and W6 Radiophones, masterpieces of cabinet art worthy only of a scientific development so outstanding.

So wonderful is the reproduction of tone in the De Forest W5 or W6 that only the presence of the lovely instrument dispels the illusion that the living artist is in the rooms.

Piano chords come to you with their full rich resonance—true piano tone. High notes

dance, ripple and sparkle . . . clearly, distinctly . . . musically! Those brooding low notes, never caught in average reception, are heard distinctly—as though from the next room.

In the reproduction of orchestral music the full importance of the De Forest achievement stands out. For the first time you get the overtones as well as the middle tones . . . the majestic roll of the kettle drums, the crooning of the bass viols, the strident crash of the brasses and the piping heraldry of the cornets and trombones. A symphony orchestra heard over the De Forest W5 or W6 stirs the soul. No incoherence, no oscillating jumble of noise—every instrument, every octave, in its true value. *A magic achievement!*

To the lover of dance music the De Forest W5 or W6 brings more sprightliness, more beauties of syncopation . . . you should hear Vincent Lopez, Joseph Knecht, The Night Hawks, or any others over either of these instruments!

All the tenderness of song, every shading of the soprano's voice, all the pathos of the folk song—exquisite but elusive elements so much desired but lost in practically all present-day reception, are captured by these De Forest masterpieces.

To everything that is broadcast, the De Forest Radiophone gives animation, life and humanness.

**But Tonal Supremacy is Not All—**

Elbert McGran Jackson, renowned sculptor, architect and painter, put into this hand-wrought, hand-carved cabinet the spirit of radio, in design, in motif—it is not an adaptation of a phonograph. An image of charming individuality, it harmonizes with the setting of any home.

One unit, everything self-contained—not a wire in sight, nothing to connect . . . and portable; move it any place! Only charm and beauty for the eye.

The artistic conical reproducer is an inseparable part of the cabinet and its tonal mechanism peerlessly attuned to that of the Weagant circuit. There are just two controls for tuning, and these operate on one dial, which makes the normally perplexing task of "tuning in" extremely simple. There are special power tubes in the fifth and sixth sockets which can give you volume to flood an auditorium, if you desire it. And, at your fingers' tips, the means to tune in a far-distant station you want no matter how powerful nearby stations may be.

See the incomparable De Forest W5 and W6 at your De Forest dealer's or write for an interesting booklet describing these masterpieces in detail.

DE FOREST RADIO CO., Jersey City, N. J.

# DE FOREST

The Greatest Name in Radio



DEALERS IN ALL CITIES AND RADIO COMMUNITIES  
THE EPOCH-MAKING ACHIEVEMENT WHICH MAKES ORDINARY RADIO RECEPTION A THING OF YESTERDAY

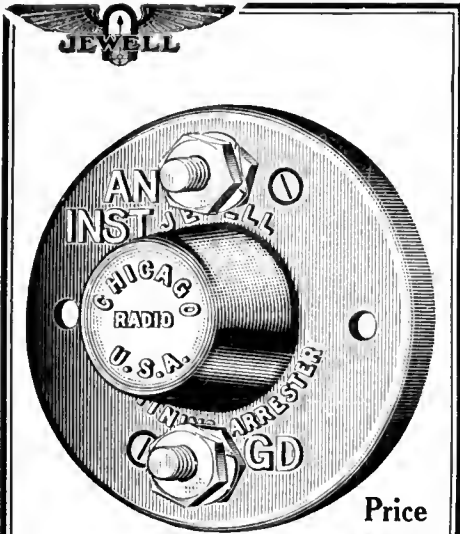

# BE SAFE—

—the Fire Underwriters Radio Code calls for the installation of a lightning arrester wherever an outside antenna is used.

## The Jewell Arrester—

—has been approved by the Underwriters (see their Certificate No. E-5403) for both indoor and outdoor installations. It is mounted in an attractive brown porcelain case and is easily installed.

## Radio Instruments—

ask your dealer for a Jewell 15-B Radio Catalog—or write to us.



**Jewell Electrical Instrument Company**

1650 Walnut St., Chicago, Ill.

*Making Good Instruments for 26 Years*

# THE GRID

A Department Devoted to Solving the Problems of our Readers

## QUERIES ANSWERED

1. WHAT IS THE PROPER METHOD FOR PLACEMENT OF COILS IN A TUNED RADIO-FREQUENCY AMPLIFIER?—F. H. J.—Houston, Texas.
2. WHAT ARE THE PRECAUTIONS THAT SHOULD BE OBSERVED IN ERECTING AN ANTENNA NEAR POWER LINES?  
C. A. C.—Buffalo, New York.

### COIL PLACEMENT IN AN R. F. AMPLIFIER

IN A receiver employing one or more stages of radio-frequency amplification, satisfactory results depend largely upon whether or not these amplifiers are properly neutralized. Now, neutralization depends upon several things. The internal capacity of the amplifier tube must be balanced; the wiring to the tube must be such that no coupling effects are obtained; and the

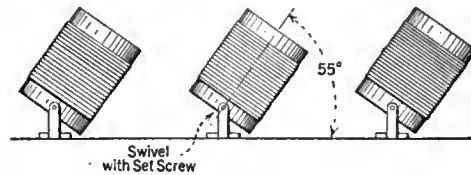

FIG. 1

several radio-frequency transformers should be so placed and located that there is no electromagnetic coupling between them. It is this last point which we will discuss here.

Most of us have had an opportunity to view the inside of a neutrodyne and to observe the peculiar angle at which the coil units are turned. At such a setting there is a minimum of coup-

3. WILL YOU DESCRIBE A METHOD OF MEASURING THE RESISTANCE OF COIL UNITS TUNED TO PREARRANGED FREQUENCIES?—B. H. R.—Utica, New York.
4. WHEN I REPLACE THE 3-VOLT TUBES IN MY SET WITH 5-VOLT TUBES, THE SET OSCILLATES. WHY?  
T. M. B.—Boston, Massachusetts.

right angle coupling between the coil units be employed. See Fig. 2.

It is most important that, in the construction of a radio-frequency amplifier, or a receiver containing one or more stages of radio frequency amplification, the tube sockets be so placed that the grid leads are as short as possible.

### PRECAUTIONS IN ANTENNA ERECTION

THE other day a serious accident occurred in Waltham, Massachusetts, caused by a young man drawing an antenna wire across an electric power line. The fact that the line was insulated did not matter as his antenna wire soon cut through the insulation, and thus the current was communicated to his body. The problem of antenna installation has caused carelessness on the part of a great many fans throughout the country, and it has been the cause of many fatalities. The following general "Don'ts" relating to antenna erection are given in a paper by Mr. Clarence V. Purcell, of the Boston Edison Company, for the benefit of those who would profit by the example of others who have been unfortunate enough to become involved in some needless mishap:

Don't run an antenna over or under any other wires carrying an electric current of any sort,

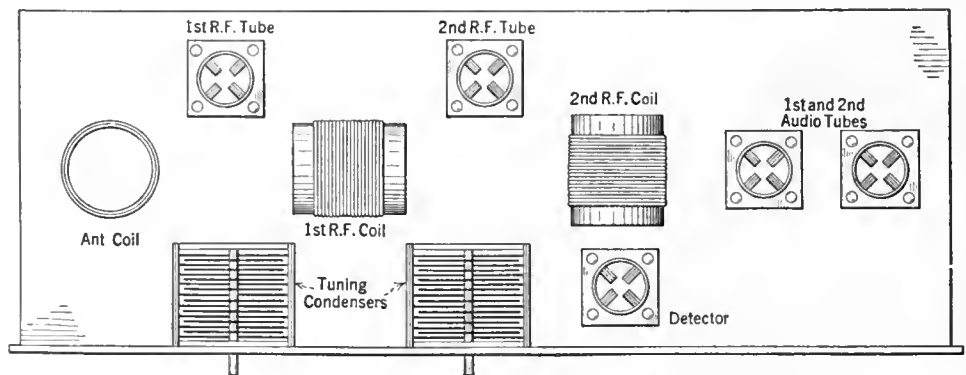

FIG. 2

ling between the coils. This placement can be approximated by the home experimenter in his own construction. Individual test must be made to determine the point at which satisfactory neutralization is obtained in the regular manner.

As an aid in obtaining the desired results, it is suggested that in the construction of a receiver the coil units be only temporarily fastened to permit ready change and variation in the angle at which they are to be set. See Fig. 1. If it is not possible to approximate this angle, which is about 55 degrees from the horizontal, or if there is plenty of space in which to construct the amplifier, then it is suggested that a

whether these wires be high tension wires, service wires, or telephone lines.

Don't attach an antenna to any pole or tower to which other wires are attached, or climb or attempt to climb such poles or towers for any purpose.

Don't run an antenna over or across any public highway.

Don't attach an antenna to any electric light, telephone or telegraph pole, even though no other wires are attached thereto. If using an outside antenna, always comply with the regulations governing the installation of an approved lightning arrester. Such a device is inexpensive and easily installed.



Radio Receiver



# This new principle of radio is exclusive in the Valleytone

### Appearance

The Valleytone is mounted in a solid walnut cabinet, finished in two tones with inlaid gold stripes. It may also be procured in beautiful console models. Special Valley tables with built-in loud speaker may be obtained for the cabinet model.

Valleytone Console Model

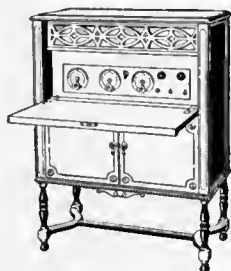

Valley table with built-in loudspeaker

Set the dials of a Valleytone for any station you choose. Bring in the signals strong and clear.

Then turn the dials one point beyond or back from the correct tuning. You merely diminish volume. The quality of the signals remains the same. There is no incoherent babble of noises.

Turn the dials two or three points either way from the correct tuning. Your program is gone.

Such tuning is possible only in the Valleytone. It is due to the *potential balance* method of preventing distortion and oscillation. . . a new principle for radio which is exclusive in the Valleytone 5-Tube Radio Receiving Set.

The *potential balance* gives a balanced tone to the Valleytone. The results are an amazing clearness and naturalness of reproduction. If you have never heard the Valleytone, a new experience in radio reception awaits you.

The *Valley Toroidal Coils* make possible a selectivity not previously achieved. Stations four or five meters apart can be brought in clearly and distinctly one after the other whether they are distant or local stations.

Before you buy a radio, hear the Valleytone. Judge it by results. Avoid regrets later by listening to the Valleytone now. Any authorized dealer will be glad to demonstrate the Valleytone for you.

VALLEYELECTRIC COMPANY, Radio Division, ST. LOUIS, U.S.A.

Branches in Principal Cities



Valleytone Receiving Sets

Valley Battery Chargers

Valley B-Eliminators

# Valley Electric

# Refine Your Receiver

WITH ONE OF THESE 3 DIALS

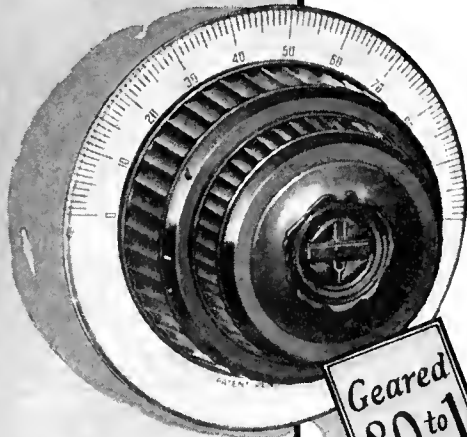

PAT. APR. 21-1925

## ACCURATUNE

REGISTERED GEARED 80 to 1 U.S. PAT. OFF.  
MICROMETER CONTROLS

**A**CCURATUNE dials not only enhance immeasurably the attractive appearance of your set but they insure clear and precise reception of programs, and with even those stations now so closely grouped on the lower wave lengths easily and readily segregated. This type recommended for Neutrodyne and Radio Frequency sets.

Priced at \$3.50



PATS. PEND.

## A. J. VERNIER

**F**OR use on Super-Heterodyne and Regenerative receiving sets, the A. J. offers a degree of tuning efficiency not usually associated with dials that sell at this price. Beautifully constructed of genuine Bakelite, the A. J. possesses a dignity of appearance that lends an air of richness to your receiver.

Priced at \$2.25

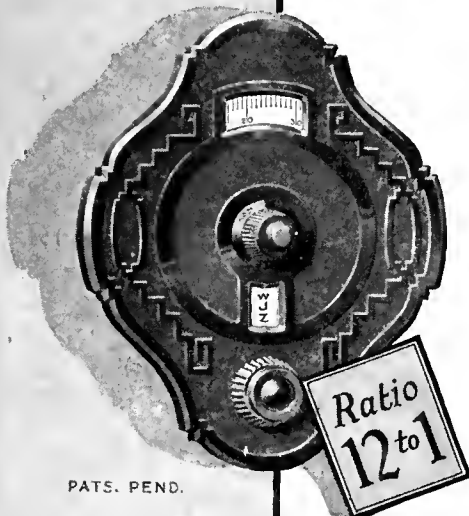

PATS. PEND.

## Recording Dial

**O**n this new style recording dial, ample space has been provided to jot down call letters, thus insuring a permanent record of dial settings. The dial itself is beautifully proportioned, made of genuine Bakelite with handsome embellishments on a matted background. Truly a product of master craftsmen who specialize in the manufacture of dials.

Priced at \$1.75

MYDAR RADIO CO. ★  
3 CAMPBELL ST.  
NEWARK, ~ N. J.

Don't borrow your neighbor's antenna by attaching your lead-in to the far end of his wire. You don't know what he is doing and besides, antenna wire is cheap and serves the purpose far better.

Don't attach your antenna to a kite. Don't use your telephone line for an antenna. Connection to an electric light socket is not encouraged or recommended; light socket attachments are approved.

### MEASURING THE RESISTANCE OF COIL UNITS

**H**ERE is described a method whereby those having the proper facilities may measure the resistance of coils tuned successively to several prearranged frequencies.

With the aid of a radio oscillator, a thermogalvanometer and a resistance box, a curve, plotting resistance against frequency, may be

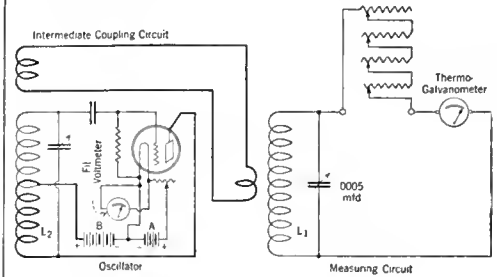

FIG. 3

made from the several readings obtained. The circuit diagram for the layout is shown in Fig. 3. To measure the resistance of a coil, the procedure is as follows, assuming that readings are to be taken at 1500 kc. (200 meters) 1200 kc. (250 meters) 1000 kc. (300 meters) and so on, for every 50 meters up the scale to 545 kc. (550 meters.)

Put the oscillator into operation setting its frequency control at 1500 kc. (200 meters). Couple the coil to be measured, L1, to the oscillator output coil L2. This will cause a deflection of the needle of the thermo-galvanometer. Now by varying the coupling between L1 and L2, the galvanometer reading may be varied to one of the numbered markings of the meter scale such as 20-40-60-70-80, etc.

Since the next step requires the addition of resistance to the measured circuit, until the reading of the meter drops to one-quarter of its original value, it is well to vary the coupling to a point where this division will be simple. At an original reading of 60 or 80, it is quite easy to add resistance to the circuit until the reading falls to 15 or 20. Resistance is added to the circuit by means of the controls on the resistance box which, until this time, had been set at zero. When the one quarter reading is obtained, reference is made to the resistance box and the resistance noted. This constitutes the resistance of the coil and the meter at that particular frequency. Usually the resistance of the meter is known and its value may be deducted from the reading obtained.

This whole system is repeated for each frequency point to be measured.

### TUBES AND R.F. COILS: HOW THEY SHOULD BE MATCHED IN A RECEIVER

**T**O OBTAIN maximum efficiency in a receiver using radio frequency amplification, it is necessary to have transformers designed for the type of tube used in the set. This statement has been amply justified as the result of exhaustive tests made by independent engineers who were interested in the problem.

If a receiver is using the c-299 or UV-199 type of dry cell tubes, with proper transformers, and is changed over to the c-301-A or UV-201-A



# DISTANCE

## THE OBEDIENT SLAVE TO YOUR DESIRES



★  
Upon request, we  
will gladly mail  
descriptive folder

APEX mastery over the most advanced radio engineering principles makes distance the obedient slave of your desires and places at your instant command the whole continent of radio enjoyment.

The infinite care and skill employed in perfecting the mechanical construction of APEX Radio Apparatus is radiantly reflected in the rich beauty of design, harmony of proportion and elegance of finish that stamp all APEX sets with an unmistakable mark of master craftsmanship.

You are cordially invited to inspect this complete showing of Quality Radio Apparatus. Only a dependable merchant is given the APEX dealer franchise. Your APEX dealer will gladly make a personal demonstration of APEX Quality Radio Apparatus.

**APEX ELECTRIC MFG. CO.**  
1410 W. 59th St., Dept. 1204 CHICAGO, ILL.

Also makers of the famous APEX Vernier Dials  
and APEX Rheostat Dials which are sold  
by every good dealer in Radio.



Apex  
Entertainer  
Price \$22.50

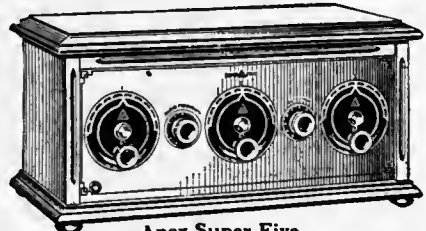

Apex Super Five  
Price \$95—without accessories



Apex Baby  
Grand Console  
Price \$225

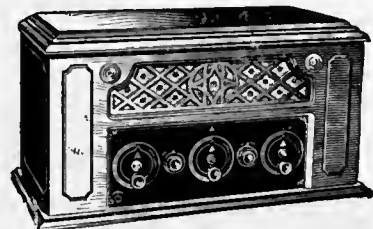

Apex De Luxe—Price \$135

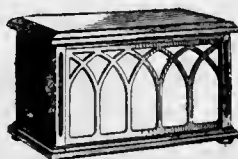

Apex  
Console  
Entertainer  
Price \$27.50



Apex Utility  
Radio Table  
Price \$75

Prices West of Rockies Slightly Higher

Canadian Prices Approximately 40% Higher

# Helps to Land Everything You Catch

The "Electrad" Lead-in meets that high quality standard set by all "Electrad's" products. There is a difference.

The convenient lead-in. Now you need not scar or mar your walls or sash with unsightly holes or ugly porcelain tubes. This flat, highly insulated and water-proofed lead-in fits under locked windows and doors. The windows may be closed tightly—there need be no loss of heat in the room. Pliable, it bends into any shape—meeting your every need. Price 40c.

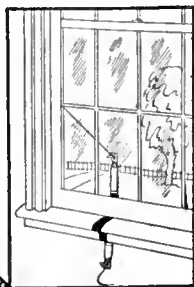

## Other Guaranteed Electrad Radio Products

which simplify construction, facilitate installation and improve reception of radio sets—Vari-ohms, Lamp Socket Antenna, Certified Grid Leaks, Resistance Coupled Amplifier Kits and many others. At your dealer's, if he can't supply, write us.

### ELECTRAD, Inc.

428 Broadway New York City

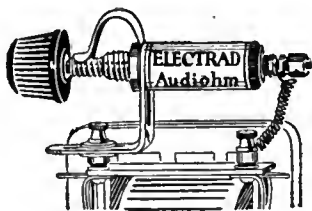

"ELECTRAD" AUDIOHM

A necessary tone and quality controlling device. Placed across secondary of first audio transformer it eliminates distortion and transformer noises. Requires no drilling, soldering or tools to attach. Fits any transformer. \$1.50 each.



"ELECTRAD" LIGHTNING ARRESTER  
Price 50c. Indoor type. Approved by Underwriters. Should fire occur from lightning you will have insurance difficulties unless you have an approved arrester.



# ELECTRAD

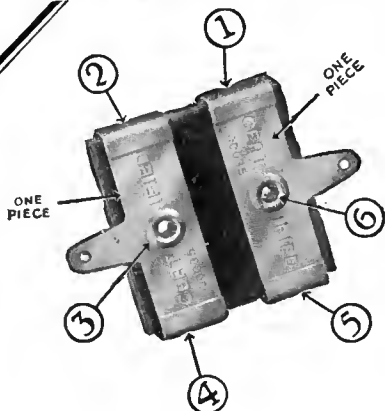

## The Six Point Pressure Condenser

The "Electrad" Certified Fixed Mica Condenser is a revelation in accuracy and design. Ingenious, rigid binding and firm riveting fastens parts securely at Six different points insuring positive electrical contact. Impervious to temperature and climatic variations. Exerts even pressure upon the largest possible surface—can't work loose. Binding strap and soldering lug in one piece. Accuracy and quietness assured always. Value guaranteed to remain within 10% of calibration. Standard capacities, 3 types. Licensed under Pat. No. 1,181,623 May 2, 1916 and applications pending. Price 30c to 75c in sealed dust and moisture proof packages.

type of tubes, it will be necessary to change the radio-frequency transformers also, if equally efficient results are to be obtained.

This is made necessary by the fact that the characteristics of the tubes vary according to their internal construction. In the UV-199 tube, the elements are very close together, making it possible and advantageous to use more wire on the primary of the transformer. The tendency for a vacuum tube having a tuned input circuit to oscillate, is proportional to the inductive load or the number of turns on the primary of the transformer in the plate circuit.

If the tubes were replaced with the C-301-A or UV-201-A type, the circuit would become unstable and oscillate readily, due to the difference in construction of the elements of the latter type of tube. Fewer turns of wire should be used on the primary of the transformers. The curve of the transformer will fall off at one end of the scale and result in poor amplification of either the high or low waves, if the proper type of tube is not used. This is due to the capacity of the input circuit of the tube, which varies in different tubes. As this is shunted across the secondary winding, it has sufficient tuning effect on that winding to shift the area of maximum amplification from the desired band.

When the tube characteristics are matched up with the correct amount of wire on the primary of the transformer, then the circuit will cover the whole wave band evenly, with good amplification. In some types the core of the transformer is filled with finely powdered iron or iron laminations. The use of iron in the core broadens tuning so that the transformer may be used over the entire wave band, without the need of a variable condenser for tuning.

### When Writing to the Grid—

A TYPEWRITTEN letter, written on one side of the paper only, is to be preferred, as it aids in the quick formation of a satisfactory reply.

Don't fail to send a stamped addressed envelope with your inquiry.

Don't send a second inquiry about the first.

Don't include questions on subscription orders or inquiries for other departments of Doubleday, Page & Company.

In asking questions give us all the information that will aid in advising you. If the question relates to apparatus described in RADIO BROADCAST, give the issue, page number, and figure number of the circuit diagram, etc.

Be explicit yet brief.

### GRID INQUIRY BLANK

Editor, The Grid  
RADIO BROADCAST  
Garden City, New York

DEAR SIR,

Please give me the fullest information on the attached questions. I enclose a stamped envelope.

I am a subscriber to RADIO BROADCAST and therefore will receive this information free of charge.

I am not a subscriber and enclose \$1 to cover cost of answers.

NAME .....

ADDRESS .....

G. D.

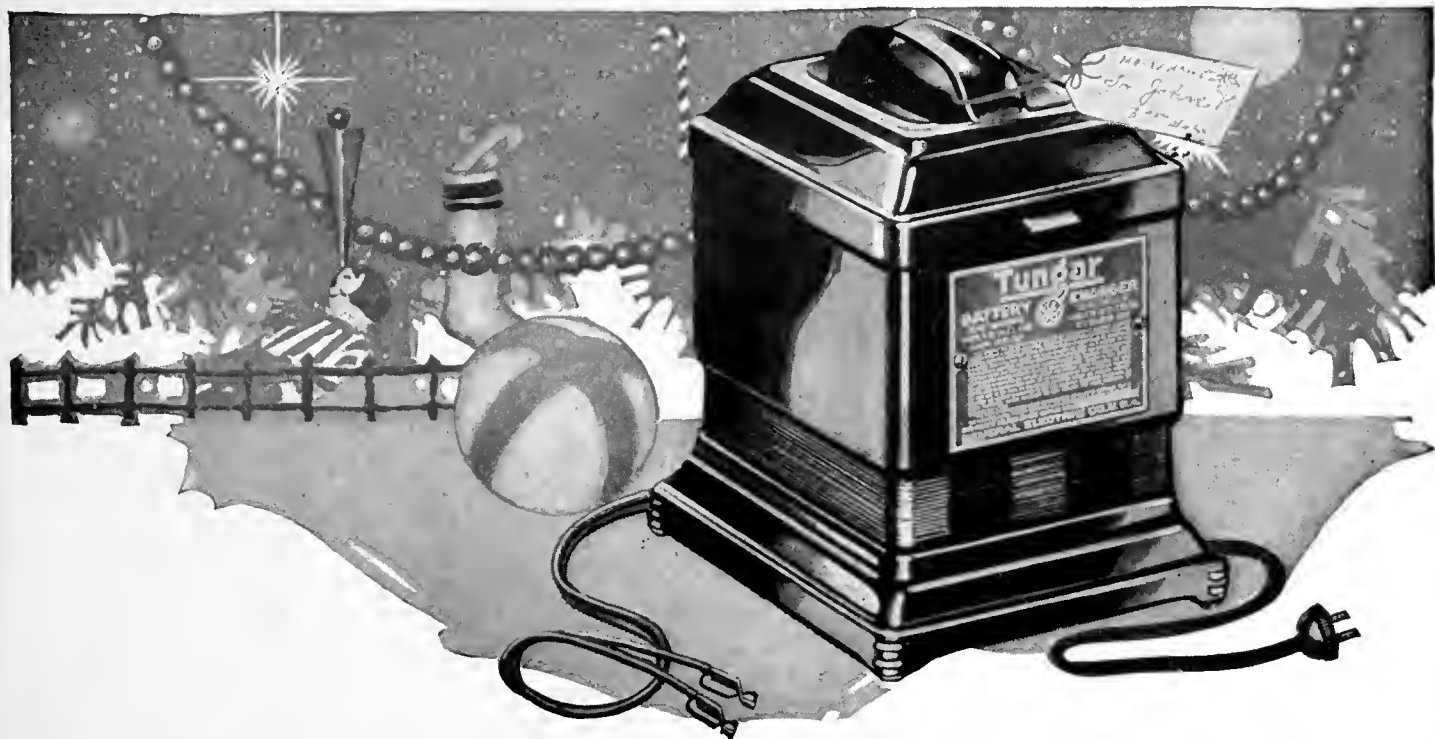

# What to give the radio fan

Give him a two-ampere Tungar if he has a storage battery of *any kind*. It will charge all his radio batteries and his auto battery, too.

Or, for bigger jobs, give him a five-ampere Tungar—built to do the same work but to do it more than twice as fast.

*Every* man who has a storage battery wants a charger. And every man who wants a charger wants the original General Electric bulb charger—the Tungar.



The Tungar is a G-E product, developed in the Research Laboratories of General Electric.

The new Tungar charges any make and size of storage battery: radio "A" and auto batteries, and "B" batteries as high as 96 volts in series.

#### Prices

Two ampere size . \$18.00  
 Five ampere size . \$28.00  
 60 cycles . . . 110 volts

# Tungar

REG. U.S. PAT. OFF.

**BATTERY CHARGER**

*Tungar—a registered trademark—is found only on the genuine. Look for it on the name plate.*

Merchandise Division  
 General Electric Company, Bridgeport, Connecticut

# GENERAL ELECTRIC

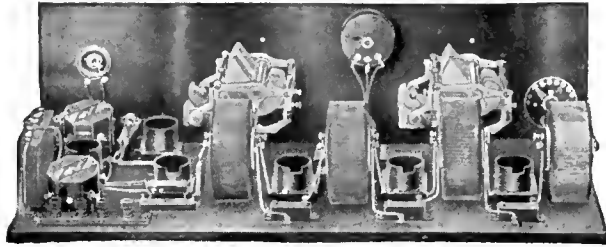

B-T "COUNTERPHASE-SIX" (Built from Kit)

## New System of Instructions Simplify Building the "COUNTERPHASE"

THE B-T "Counterphase" is a combination of the best apparatus ever put in a receiver and the exclusive patented B-T method of oscillation control which gives maximum efficiency on all wave lengths.

You can build the "Counterphase" with one, two or three stages of R. F. or buy a complete factory built 6-tube receiver. Two tuning controls give the most simple as well as sensible tuning.

"Counterphase" kits for the home builder include a complete set of instructions with progressive circuit charts in nine colors (the same colors as wires furnished.) There's no excuse for error.

Ask your dealer, he'll tell you about B-T performance.

### "The Best We Ever Tested—"

says a leading laboratory of the B-T "Euphonic" Audio Transformers.

Listen to a set equipped with "Euphonics" and you'll appreciate the improvement on both high and low notes.

The B-T "Euphonic" is the only transformer designed to permit mounting in such manner that terminals may always be brought where they are needed to prevent crossed wiring, a frequent cause of howling and distortion.

Compare the tone and you'll use only "Euphonics."

Because It's Different  
You Should Read  
Better Tuning

before you buy a set or parts. 80 pages of facts, hook-ups, tuning hints, discussions of latest radio topics. Postpaid, 10 cents. Literature describing B-T products free on request.

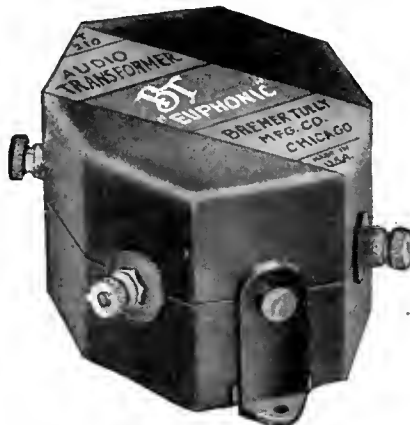

RADIO: 2.2 to 1 Price \$5.00  
4.7 to 1 Price \$5.75

BREMER-TULLY MFG. CO.

532 S Canal Street

Chicago, Ill.

## A KEY TO RECENT RADIO ARTICLES

By E. G. SHAULKHAUSER

THIS is the second instalment of references to articles which have appeared recently in various radio periodicals. Each separate reference should be cut out and pasted on cards for filing, or they may be pasted in a scrap book either alphabetically or numerically. A brief outline of the Dewey Decimal System (employed here) appeared in the November RADIO BROADCAST.



R113. TRANSMISSION PHENOMENA. TRANSMISSION PHENOMENA.  
*Popular Radio*, Sept. 1925, pp. 199-206.  
"How the Air Affects Radio," E. E. Free.

In a simple non-technical way the author tells us how the two theories of wave propagation, the Heaviside Layer theory and the Gliding Wave theory, may affect radio transmission. Probably both theories are correct. Apparently the ions and free electrons in the air account for fading, bending, and absorption. Sir Joseph Larmor, on October 27, 1924, stated that he believes most of the phenomena pertaining to wave reflection occurs about fifty miles above the earth's surface. How free electrons may affect radio energy distribution is explained in greater detail.

R113. TRANSMISSION PHENOMENA. ABSORPTION.  
*Popular Radio*, Sept. 1925, pp. 207-211.  
"How Radio Dead-Spots are Found by a Wandering Broadcasting Station," J. O. Perrine.

The distribution of radio wave energy about a broadcasting station located in a city, has been determined with the aid of a mobile receiving set. Energy received is compared with that given out by a local oscillator, and field strength is recorded in microvolts per meter. The area about the Washington, District of Columbia station, WCAP, within a radius of 50 miles, is shown in diagram with contour lines. These tests have given very valuable and interesting results, showing effect of ground condition, buildings, hills, and various conducting materials found in the earth, on the direction and intensity of the wave.

Ro80. COLLECTIONS, TABLES, MISCELLANEOUS. TABLES  
*Popular Radio*, Sept. 1925, pp. 221-226.

"Useful Charts for Amateurs," Lieut. C. C. Todd, jr. Simple and valuable information to guide the constructor in designing coils and determining proper size condensers to cover certain wavebands, is contained in this article. Eight charts show the relation between capacity, inductance, wavelength, and coil turns, to cover both short and long wavelengths. The information is very well presented and the diagrams are clear.

R800 (530) PHYSICS. ATOMS  
*Popular Radio*, Sept. 1925, pp. 232-236.

"The Atom," Sir William Bragg. Article No. 2 deals with the nature of gases. The arrangement of the electrons in various atoms, their number, and how the various combinations account for the different elements, is described. Models illustrate the facts outlined in a very simple way. The author relates the theory of the electrons and atoms and the part they play in our present day research, in simple language.

R360. RECEIVING SETS. FREED-EISEMANN.  
*Popular Radio*, Sept. 1925, pp. 244-254.  
"How to Get the Most out of Your Ready-Made Receiver," S. G. Taylor.

The new Freed-Eisemann five tube receiver, NR20, is discussed, illustrated, and described in great detail. A description of the theory, operation, and equipment, with plenty of photographs and diagrams, give the set owner all the desired information. The B battery life for this set, using various sizes of B batteries, is shown in a table.

R304.1 WAVEMETERS. WAVEMETERS.  
*Popular Radio*, Sept. 1925, pp. 267-271.  
"An Oscillating Wavemeter," S. G. Taylor.

A description of an oscillating wavemeter, using a vacuum tube in a simple oscillating circuit, is given. Parts required, and size of coils to use in order to cover frequencies from 9091 kc. (33 meters) to 498 kc. (602 meters), are listed. The instrument is valuable in measuring capacities and inductances. The circuit diagram shown is the modified Hartley.

R343. ELECTRON TUBE RECEIVING SETS. RECEIVER,  
*Radio Engineering*, Sept. 1925, pp. 433-441. RX-1.  
"How to Build the RX-1."

This receiver is one especially developed in the Darien Laboratory. It is a non-regenerative four-tube set known as the RX-1 receiver. The receiver was designed to give easy control, good quality, and precise tuning, together with plenty of volume. Diagrams and data are ample to permit the constructor to build this receiver. The best parts available are listed, the cost of these being only about \$32.

R720. PROCESSES. MOULDING.  
*Radio Engineering*, Sept. 1925, pp. 455-458. BAKELITE.  
"Why Not Do Your Own Moulding."

The article describes the equipment necessary for moulding bakelite parts on a rather small scale. The process is not difficult and the equipment can be installed in small establishments without excessive cost. The method used in making molded parts is described in detail. Photographs of the machinery are shown.

R384.1. WAVEMETERS. LECHER WIRES.  
QST, Sept. 1925, pp. 11-12.  
"Practical Lecher Wires," E. C. Woodruff.

Description and arrangement of Lecher wires with constants of construction are given in detail, showing diagram. In making measurements of waves the wires are connected to a vacuum tube circuit as shown in Fig. 1, and a milliammeter in the plate circuit indicates resonance. A calibration chart and graph show the method of using these parallel wires.

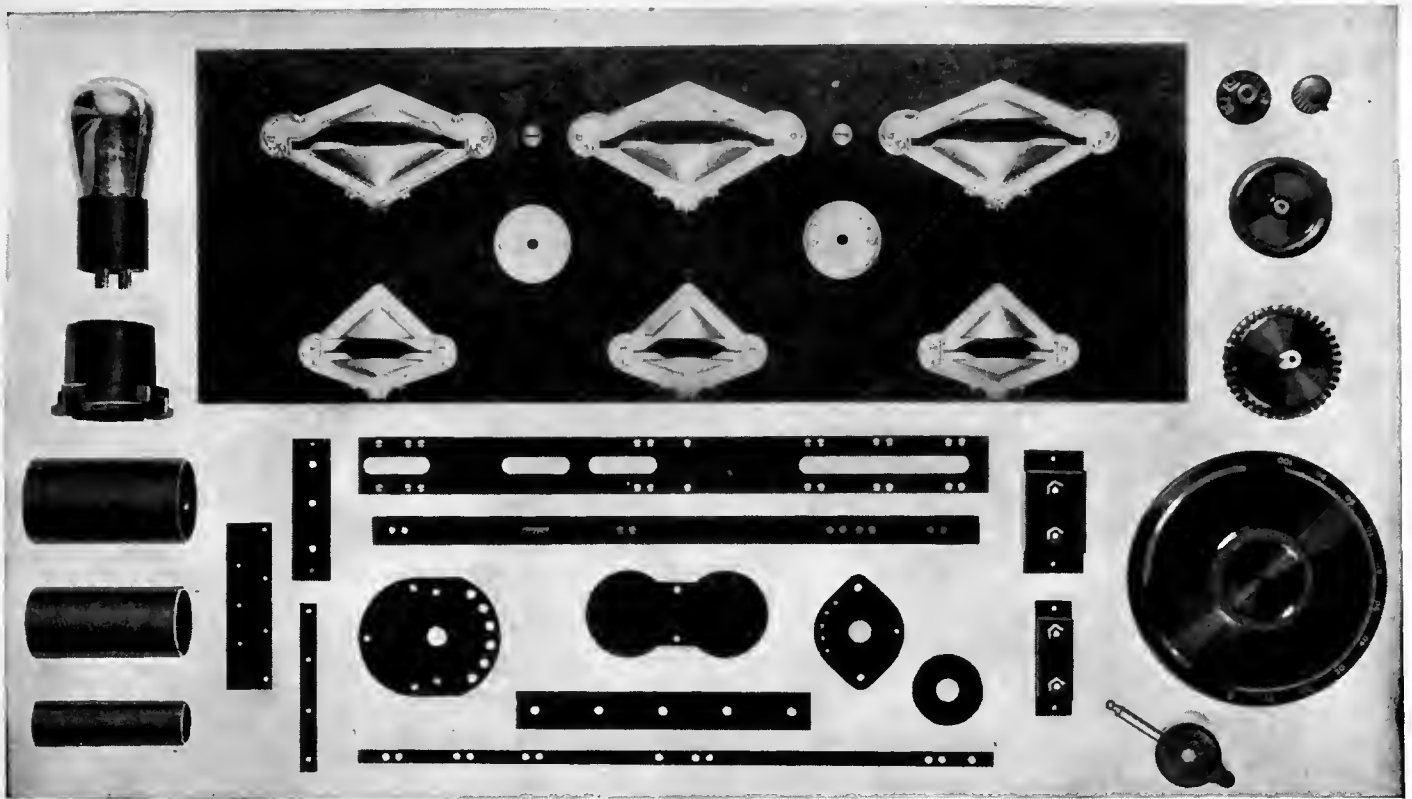

## Imagine a Radio Set stripped of these parts

What a useless collection of wood, wire and metal it would be. Realizing that the parts and accessories shown here are wholly or partly of Bakelite, gives you a vivid picture of its importance to Radio.

To-day Bakelite is used in a greater variety of radio parts than ever before—and the number grows constantly. This dominance of Bakelite in radio

reflects the experience and the opinions of radio manufacturers, great and small.

Radio set and parts manufacturers have every facility for testing all insulation materials and over 95% have standardized on Bakelite. This indicates how really important it is for you to make sure that the set or parts that you buy are Bakelite insulated.

*Write for Booklet 29*

### BAKELITE CORPORATION

247 Park Avenue, New York, N. Y.  
Chicago Office: 636 West 22d Street



Bakelite is an exclusive trade mark and can be used only on products made from materials manufactured by the Bakelite Corporation. It is the only material which may bear this famous mark of excellence.

# BAKELITE

REG. U.S. PAT. OFF.

  
**BAKELITE**  
is the registered trade mark for the phenol resin product manufactured under patents owned by the Bakelite Corporation.

## THE MATERIAL OF A THOUSAND USES

★ Tested and approved by RADIO BROADCAST ★



Merry Christmas  
for Everybody

**A** BRISTOL Loud Speaker will bring everlasting Christmas joy to the whole family.

It has all the volume you will ever wish, but its fine point,—its outstanding claim for distinction, is its tone, a true, clear, natural reception of voice or instrumental music. This is because it is a true musical instrument not merely a phone unit in a horn.

Bristol Loud Speakers have highly developed electromagnetic tone mechanisms, and non-metallic horns with long, freely vibrating sound chambers.

The super S and super C models are equipped with the Super-Unit which contains a specially designed diaphragm of broad pitch range. It reproduces not only the low pitched notes but the high as well.

There are four Bristol Speakers, horn or cabinet type, priced at \$15.00 to \$30.00. If not at your dealer's, send for our new booklet. "How to select your loud speaker."

THE BRISTOL COMPANY, Radio Div. WATERBURY, CONN.  
AH.

For 36 Years Makers of highly accurate and sensitive Bristol Recording Instruments.

**BRISTOL** AUDIOPHONE Loud Speaker

Ro84. TABLES. CHARTS.  
QST. Sept. 1925, pp. 16-17. *Ind. & w. l.*  
"Designing the Secondary Coil," G. H. Burchill.  
Using double cotton covered wire, the inductance and wavelength of cylindrical coils, closely wound, can readily be determined with the aid of the chart in the form of a graph. A simple description of coil design and method of procedure is given.

R800 (535.3). PHOTOELECTRIC SELENIUM CELLS. PHENOMENA  
*Radio Engineering.* Sept. 1925, pp. 442-443.  
"Selenium and Photoelectric Cells," S. Wein.

The third chapter on selenium cells gives the construction of different types of cells by various scientists: Tainter, Bell, Mercadier, Townsend, and Cherry. References are listed.

R356. TRANSFORMERS. TRANSFORMERS.  
QST. Sept. 1925, pp. 21-24.  
"Transformers and Reactors in Radio Sets," R. H. Chadwick.

In the first article on transformers and reactors, the author takes up the general theory, regulation, and efficiency, and describes the construction and operating principles of various types of commercial transformers. The leakage reactance is a governing factor in proper transformer design. Useful information for users of these instruments.

R342.15. AMPLIFIER TRANSFORMER. AMPLIFYING  
QST. Sept. 1925, pp. 27-29. TRANSFORMERS.  
"High Ratio and High Amplification," R. S. Kruse.

Some misunderstood principles about audio and radio-frequency transformers are cleared up by the author. Stage to stage amplification depends on the regeneration as well as the transformation ratio and the tube constants. When the transformer is largest, both regeneration and amplification are strongest. A 2:1 transformer may give much better amplification than a 6:1, depending upon design. Diagrams illustrate the points under consideration.

R402. SHORT WAVE TRANSMITTERS. SHORT WAVE  
QST. Sept. 1925, pp. 30-32. TRANSMITTER.  
"A Power-Amplifier Transmitter for the Low Waves," W. H. Hoffman.

The circuit arrangement in a Colpitts oscillator, using an added power amplifier, is described. The transmitter operates well on very short wavelengths. It transmits a very steady frequency and with the apparatus recommended, has a tuning range from 14990-3804 kc. (20-77 meters). Since the set uses UV-202 tubes it can be operated on storage or dry batteries, and used as an emergency layout. Operating adjustments and list of parts required, including circuit diagram, give complete construction data.

R113.4. IONIZATION; HEAVISIDE LAYER. HEAVISIDE  
QST. Sept. 1925, pp. 33-34. LAYER THEORY.  
"Is There a Heaviside Layer?" G. W. Pickard.

A brief discussion concerning some of the transmission phenomena, with particular reference to various theories on reflection and refraction, is contained in a letter to QST by the writer.

R512. RADIO BEACONS. LIGHTHOUSE,  
RADIO BROADCAST. Oct. 1925, pp. 719-724. RADIO.  
"And Now—The Radio Lighthouse," J. C. Young.

Radio service to ships at sea has become absolutely necessary. Radio signals help guide ships when near the coast and give bearings when needed. What advances have been made in guarding against danger, what pleasure and enjoyment has been derived through the use of radio to those sailing the waters, is well pictured in this article.

R140. RADIO CIRCUITS. ROBERTS  
RADIO BROADCAST. Oct. 1925, pp. 725-731. CIRCUIT.  
"New Developments and Experiments with Receiving Circuits," K. Henney.

The Roberts Knockout receiver offers possibilities for development along many lines. In this article some of the experiments carried on at the RADIO BROADCAST Laboratory with this circuit, are discussed. How a fifth tube may be added, how the reflex stage may be eliminated, how the circuit is neutralized, how regeneration may be employed in either detector or amplifier, are changes that may be tried with success.

Ro07. 2. U. S. RADIO INSPECTION SERVICE. RADIO  
RADIO BROADCAST. Oct. 1925, pp. 743-744. CONDITIONS.  
"Guiding the Good Ship Radio," D. K. Tripp.

An interview with W. D. Terrell, Chief Supervisor of Radio, concerning radio conditions in the U. S. at present, reveals his views about the department's attitude toward the amateur, the broadcaster, and the service both can render toward bettering conditions in radio.

R132. AMPLIFYING ACTION. AMPLIFYING  
RADIO BROADCAST. Oct. 1925, pp. 745-750. PRINCIPLES.  
"Some Remarks on Audio Amplification," G. C. Crom, Jr.

Good radio reception depends upon proper amplifier design. The functions of each part in the amplifier circuit are discussed in detail. Good parts must be used for best reproduction. Distortion may be produced by any one of four things as stated. High plate voltages are recommended and are of advantage when proper C battery voltages and by-pass condensers are inserted, as shown in Fig. 2.

R373. 2. MICROPHONES. MICROPHONE  
RADIO BROADCAST. Oct. 1925, pp. 769-770. PLACING.  
"More About How to Place the Microphone."

Methods of placing microphones for picking up band and orchestra music in and out of the station studio, are shown. In particular, the placing of several microphones at the Lewisohn Stadium in New York City and on the campus of New York University, in order to broadcast music from large organizations, is of interest.

R375.3 ELECTROLYTIC RECTIFIERS. RECTIFIERS,  
RADIO BROADCAST. Oct. 1925, pp. 774-780. CHEMICAL.  
"Notes On Chemical Plate Supply Units," J. Millen.

The chemical rectifier here described, employs two or more jars in order to handle output voltages up to 150 volts and enough current for the receiver, at the same time giving absolutely no line hum in the output circuit. The discussion covers all phases of construction and operation in a very thorough manner. List of parts and diagrams of circuits and complete unit are added.

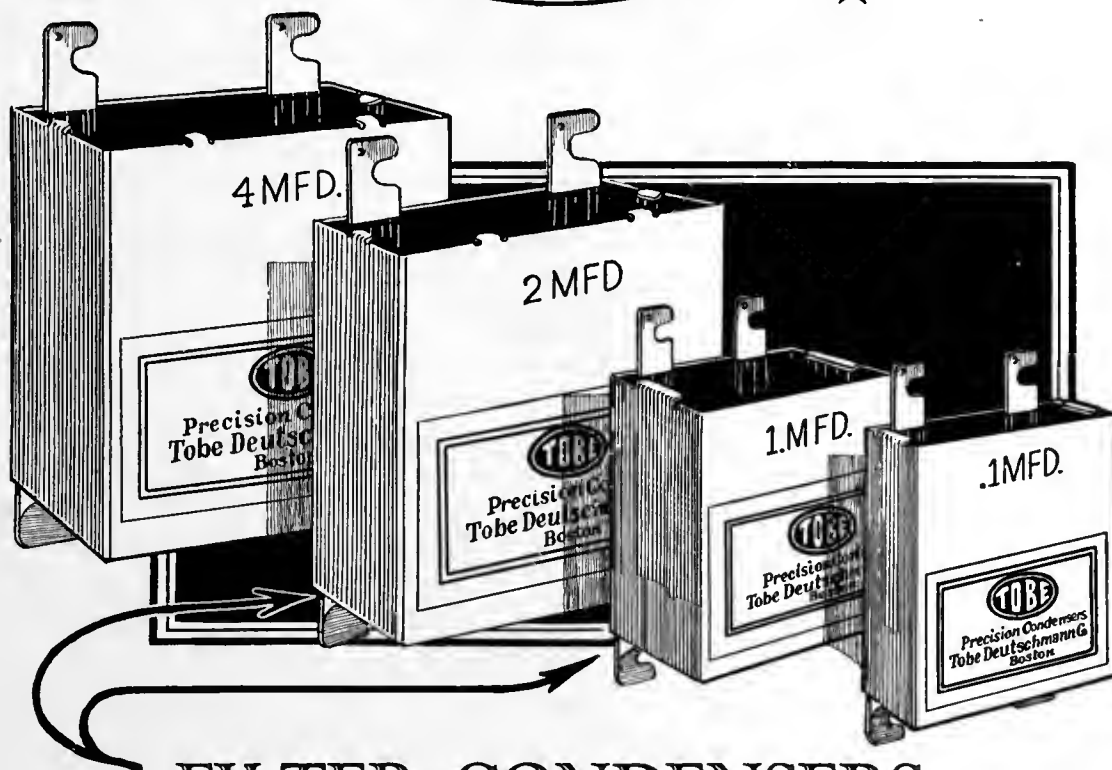

## FILTER CONDENSERS

*recommended for Raytheon Plate  
current circuits*

**R**ADIO BROADCAST'S article in this issue on "An Improved Plate Current Supply Unit" shows that the following TOBE condensers can be used in building the set: 5 type 708 and 7 type 709.

Any 'B' battery eliminator circuit depends very largely for its operating efficiency upon the filter condensers used. TOBE condensers alone possess all of the following favorable characteristics:

Will operate at voltages up to 700 D. C. without breakdown or overheating.

High megohm resistance—indicating perfect insulation. Capacities guaranteed to be within 5% of accuracy.

Extreme heat or cold has no effect on TOBE condensers. Compact and handsome in appearance.

Tobe condensers are better condensers—distinguishable by their silvered finished case. Ask your dealer for them by name "TOBE."

.1 M.F.D.	Type 705	Price \$ .70
1. M.F.D.	Type 708	Price 1.25
2. M.F.D.	Type 709	Price 1.75
4. M.F.D.	Type 711	Price 3.75

**Tobe Deutschmann Company**  
CORNHILL BOSTON, MASS.

# NOW you can buy Matched Tubes

and be certain your reception will be  
clear, smooth, loud and uniform



Sylfan

## Blue Specials

cost a trifle more and are worth it. Try them, and you'll never again bother to try to match tubes yourself. 501-A is for storage batteries, and is packed singly and in kits of three and five matched tubes. 499 is for dry cells, with peanut base and is packed singly and in kits of four and six matched tubes.

Price \$2.75 each

Buy them by the box  
for best reception.



# Sylfan

## Matched Blue Tubes

(Peanut or Standard Types)

mark a new step in Radio. They are what every radio "bug" has been looking for and wondering when and where they could get them.

It is most important to good radio reception that your tubes are matched—and pull in harmony. Equal pull in the tubes means smoothness of reception—sweetness of sound—full throated volume—resonant clarity.

**Sylfan** BLUE SPECIALS are matched tubes. After careful selection by actual test the individual characteristics are plainly indicated and they are packed in kits of three and five matched tubes—ready for immediate use. Made for storage batteries only.

This process of selection enables us also to discard all inferior tubes and retain only the first grade.

**Sylfan** BLUE SPECIALS give wonderful results. Try them. Find out for yourself what a big advantage it is to have matched tubes. Remember they are unconditionally guaranteed.

See the Sylfan line Booth No. 34  
Chicago Radio Exposition

Manufactured and Marketed Exclusively Thru Jobbers by

### BAKER-SMITH CO., Inc.

New Call Building, San Francisco

Branch Office Addresses

Portland, Ore., Henry Bldg.	New York City, 1270 Broadway
Salt Lake City, Atlas Bldg.	Chicago, 30 N. Dearborn St.
Seattle, L. C. Smith Bldg.	Denver, McClintock Bldg.
Los Angeles, 443 South San Pedro Street	
Vancouver, B. C., 179 Pender Street, West	

R550. BROADCASTING. SUPER-POWER  
RADIO BROADCAST. Oct. 1925, pp. 761-768. STATIONS.  
"A Debate: Resolved, That 500-watt Stations Are Not  
Sufficient for Program Service." Affirmative: Mr.  
Dreher. Negative: Prof. Williams.  
The pros and cons of so-called super-power stations, is  
given in two articles. Much information is contained in  
both, especially in regard to power and noise level.

R113-1. FADING. FADING  
"Radio News." Sept. 1925, pp. 278ff. SIGNALS.  
"Concerning the Nature of Fading," J. H. Dellinger.  
The problem of fading has become more serious than  
the problem of static, primarily because so much fading  
occurs on the high frequencies (1500 kc. and up) where  
much research is being done at present. The Bureau of  
Standards has undertaken a series of tests to determine  
the cause of fading. It is probably due to the shifting  
of the upper atmospheric conducting surface.

R582. TRANSMISSION OF PHOTOGRAPHS. PHOTOGRAPH  
"Radio News." Sept. 1925, pp. 278ff. TRANSMISSION.  
"See With Your Radio," W. B. Arvin.  
The Jenkins-Moore system of television is described.  
A photoelectric cell converts the black and white of a  
picture into electric currents while a lighting device, the Moore  
lamp, picks up these currents and changes them back to  
light and shadow on the screen. The breaking up of the  
picture for transmission is done with the prismatic disc,  
a very simple method. Synchronization is accomplished with  
synchronous motors at both ends. This system is said to  
be the best one developed to-day, and was demonstrated  
at Washington last June.

R323. GROUND AND UNDERGROUND UNDERGROUND  
ANTENNAE ANTENNAE  
"Radio News." Sept. 1925, pp. 301ff.  
"Underground Radio," W. H. M. Watson.  
Experiments with underground antennas with frequencies  
of from 5996 kc. (50 meters) to 1666 kc. (180 meters) are  
described in detail, with varying results. Good transmission  
distance is possible with low power input after proper ad-  
justments are made and antenna placed properly. The  
antenna is very directional.—An article on underground and  
under-water antennas, is reprinted from Dec. 1919, *Radio  
News* showing what was accomplished along this line  
several years ago.

R381. CONDENSERS. CONDENSERS,  
"Radio News." Sept. 1925, pp. 308ff. S. L. F.  
"More About Straight Line Frequency Condensers," S.  
Harris.  
A general discussion concerning condensers, in particular  
the straight line frequency condensers, is presented to clear  
up certain points. The question of low minimum capacity  
for definite sized condensers, of condenser resistance when  
plates are nearly all the way out, and of tuning with  
straight line frequency condensers, is considered.

R140. RADIO CIRCUITS. REGENERATIVE  
"Radio News." Sept. 1925, pp. 310ff. CIRCUITS.  
"Single-Tube Circuits," L. W. Hatry.  
The author reviews regenerative circuits, inductive and  
capacitive, using one tube. All other circuits are merely  
combinations of these simple circuits. A good understand-  
ing of these, makes the "dynes" and "plexes" comparatively  
simple. The Reinartz, the ultra-audio, the Cockaday,  
and others, receive considerable attention in this discussion.

R430. INTERFERENCE ELIMINATION. INTERFERENCE  
"Radio News." Sept. 1925, pp. 290ff. REDUCTION.  
"Directional Reception Reduces Interference," P. C.  
Hoernel.  
A method of reducing interference is here described,  
utilizing loops for directional reception. The system is  
developed by Mr. Friis of the Bell Telephone Company. In  
order to neutralize or reinforce the voltages obtained from  
the two loops, the latter are mounted on a long turntable  
at some distance apart (depending on wavelength). Fig. 3  
shows the general form of the directional characteristics,  
and Fig. 1 the circuit used. Several photographs give an  
idea of the general layout. The tuning is simple and the  
results obtained were very good. Amateurs and experi-  
menters can amplify along these lines.

R375. DETECTORS AND RECTIFIERS. RECTIFIER  
"Radio News." Sept. 1925, pp. 293ff. TUBE.  
"A New Neon-Filled Rectifier Tube," J. Riley.  
The tube used as rectifier for B battery eliminators has  
two electrodes of aluminum, a rod and a cylinder, and con-  
tains neon gas at a pressure of six millimeters of mercury.  
Its action in d. c. and a. c. circuits is discussed in detail  
and illustrated by diagrams. Other possibilities of the  
neon lamp are enumerated and offer a field of research.

R351. SIMPLE OSCILLATORS. OSCILLATOR.  
"Radio Journal." Sept. 1925, pp. 12-15.  
"A Laboratory Oscillator," H. W. Leighton.  
The author describes the construction of a laboratory  
oscillator and gives some of its uses. The circuit is shown  
in Fig. 1. Calibration of the oscillator is simple when a  
standard wavemeter is available. Measurements of trans-  
formers and filter for use in super-heterodynes are made  
according to Fig. 2, and curves plotted showing how one  
can determine just how to select the proper apparatus to  
match. Small fixed condensers can also be measured with  
this oscillator.

R343. ELECTRON TUBE RECEIVING SETS. RECEIVER,  
"Radio Journal." Sept. 1925, pp. 14. BROWNING-  
DRAKE.  
"New Type Browning-Drake," Bill Massaggee.  
The constructional details of the Browning-Drake re-  
ceiver are described, particular attention being called to  
several minor details which nevertheless are essential if the  
set is to operate well. A proper design of the coils used is  
essential. Extreme selectivity and sensitivity is claimed  
for the 4-tube set in comparison to other sets of similar  
size. (Further details in Oct. issue)

R360. RECEIVING SETS. GREBE CR. 17  
"Radio Journal." Sept. 1925, pp. 15.  
"The New Grebe CR-17," M. Best.  
Photographs and wiring diagram of the Grebe short wave  
receiver, including a short description of the operating  
principles, is given.



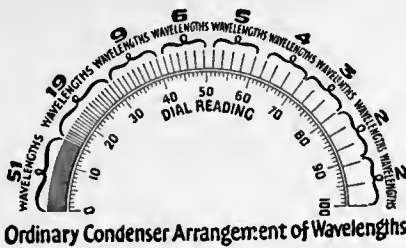

Ordinary straight capacity condensers crowd 70 of the 100 wavelengths into the first 30 points of the dial.

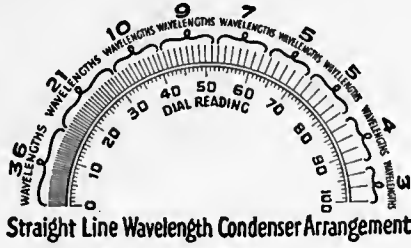

With straight-line-wavelength condensers 57 of the 100 wavelengths are crowded into the first 30 points of the dial.

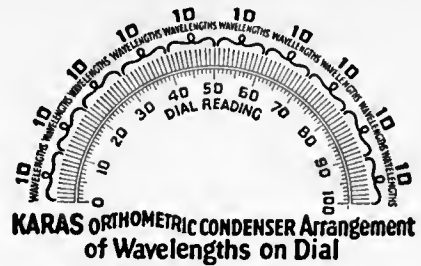

The New, Scientific Karas Orthometric Condensers insure absolutely equal separation on the dial of all wavelengths throughout the entire broadcasting range.

# Tuning Marvelously Simplified with Karas Orthometric Condensers

The condenser that brings in KDKA where it belongs—at 53 on the dial. Remember, 52 of the 100 allotted wavelengths must come in below KDKA.

Note the Long Eccentric Plates

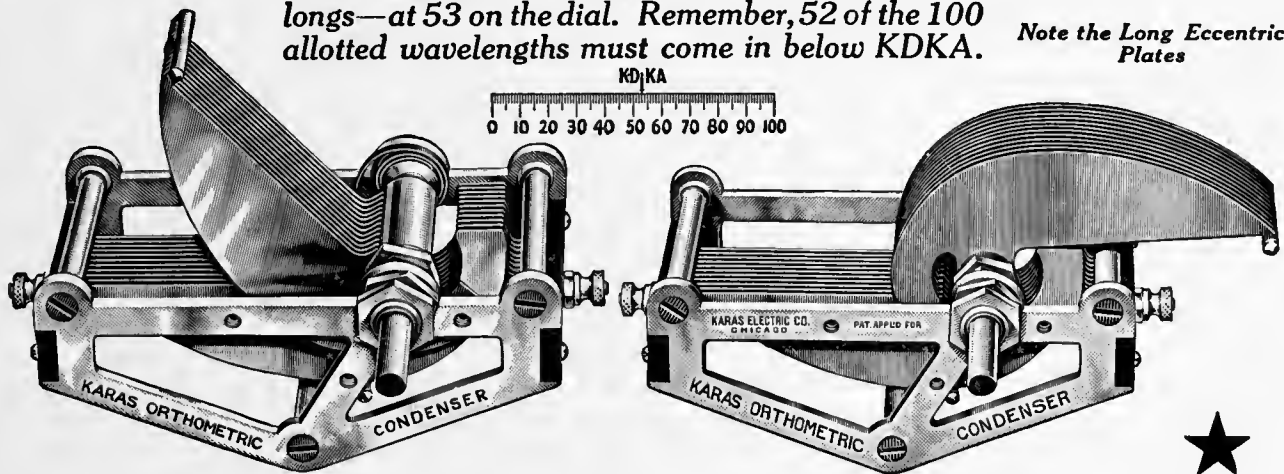

## Spreads Stations Evenly Over the Dial — No Crowding Whatever

THE Karas Orthometric Condenser positively separates all adjoining wavelengths by EQUAL distances on the dial, giving you the full benefit of the 10 Kilocycle frequency separation fixed by the Government.

Ordinary condensers jam 70 of the 100 Government allotted wavelengths into the first 30 points of the dial—even straight-line-wavelength condensers crowd 57 of them below 30.

With Karas Orthometrics, each point on the dial corresponds exactly to one of the 100 allotted wavelengths. The result is marvelous simplicity in tuning—better, clearer reception—you get all the side bands without interference.

The Karas Orthometric stands absolutely alone!—an eccentric condenser, scientifically designed for present

day broadcast receiving sets—the Last Word in making REAL SELECTIVITY POSSIBLE.

The Karas Orthometric is a “job” that will delight the eye of the mechanical critic. It is made entirely of brass—frame and plates all die stamped—plates, patent leveled and solidly bridged to insure permanent rigidity and alignment. Every joint throughout is soldered. Grounded frame and rotor, with stator plates supported on hard rubber insulation. Tapered adjustable cone bearings, spring copper pigtail connection, automatic stops—in short, a condenser that is both theoretically and mechanically perfect.

## If Your Dealer is Not Yet Supplied, Order on this Coupon

We are supplying Jobbers and Dealers as fast as the output of our factory permits. If your dealer is not yet supplied, order direct on the coupon. You need send no money with your order. Condensers will be delivered C.O.D., and you receive them subject to our unconditional guarantee of satisfaction. Why run the risk of delay? Order NOW!

### Money Back Guarantee

Karas Orthometric Condensers are unconditionally guaranteed to give you absolute satisfaction. They may be returned for full refund any time within 30 days.

**SIZES AND PRICES**  
 23 plate, .0005 Mfd., \$7.00  
 17 plate, .00037 Mfd., 6.75  
 11 plate, .00025 Mfd., 6.50

**Karas Electric Co., 4042 Rockwell St., Chicago**  
 For Over 30 Years Makers of PRECISION Electrical Apparatus

### Send No Money With this Coupon—

Karas Electric Co., 4042 N. Rockwell St., Chicago

Please send me ----- Karas Orthometric Condensers, size ----- at \$----- each. I will pay the postman the list price, plus postage, on delivery. It is understood that I have the privilege of returning these condensers any time within 30 days if they do not prove entirely satisfactory, and you will refund my money at once.

Name -----

Address -----

Dealer's Name -----

If you send cash with order, we'll send condensers postpaid.



The ORIGINAL HI-MU TUBE

for Resistance-Coupled Amplifiers \$3.00

# CLEARTRON

**GUARANTEED**



**RADIO TUBES**

To increase the efficiency of a receiver employing Resistance-Coupled Amplification, and to get the full measure of tone purity and faithfulness of reproduction, for which this method of amplification is noted, use Cleartron Hi-Constron Tubes—Type 101A.

The Cleartron Hi-Constron is a Hi-Mu Tube with an amplification constant of 20, especially designed for Resistance-Coupled and Reactance-Coupled Amplifiers. It is the result of years of research work and is the original and genuine Hi-Mu Tube.

**IRON-CLAD GUARANTEE**

All Cleartron Tubes are guaranteed to deliver positively perfect service and we authorize our distributors to make replacement of any Cleartron Tube which proves unsatisfactory to the user. The only requirement is that the tube must not have been burned out.

Cleartron Vacuum Tube Co.  
28 West 44th St.  
New York City

The Following Types \$2.50

- |                       |  |
|-----------------------|--|
| C-T 201 A             | CTX 120  |
| C-T 199 Standard Base | C-T 400 Rectron Tube for "B" Battery Eliminators |
| C-T 199 Small Base    |  |

CTX 112 Power Tube \$6.50

All Types Equipped With Genuine Bakelite Bases

At All Reliable Dealers ★

Write for FREE six-page folder giving valuable information regarding radio tubes

## Cleartron Vacuum Tube Company

Executive Offices  
28 West 44th Street  
New York City

Factories  
West New York, N. J., U. S. A.  
Birmingham, England

# FOR BETTER RECEPTION

## Is Your Set A Blooper?

How to Prevent Your Receiver Causing Interference and Thus Spoiling Your Neighbor's Reception

There are still many single-circuit bloomers in use, although the general trend in design, as far as commercially made receivers are concerned, seems to be toward receivers which are almost incapable of causing interference, however carelessly handled. The excellent instructions appearing below have been specially prepared by the Radio Branch of the Department of Marine and Fisheries of the Dominion of Canada, for circularization among all Canadian broadcast listeners. On the back of all Canadian receiving licenses is the following note. "When using a receiver of the regenerative type for the reception of radio telephone programs, please avoid increasing regeneration to the point at which the receiver begins to oscillate, otherwise you will cause interference with neighboring receiving equipments. Are you doing your best to observe this?" The point is that many owners of receiving sets capable of radiating squeals, cause such interference purely from inadequate knowledge of the handling of their sets, and it was for their benefit that this circular was printed. These instructions should help many readers of RADIO BROADCAST who are looking for clear directions on how properly to use their regenerative sets.—THE EDITOR.

### HOW MUCH INTERFERENCE A RECEIVER CAN CAUSE

A RECENT survey of radio broadcast reception conditions in the more populated centers of the Dominion of Canada indicates that approximately fifty per cent. of the "preventable interference" which prevails, is caused through the incorrect operation of regenerative receiving sets by the broadcast listeners themselves.

The survey further indicates that most of the interference is due to a lack of knowledge of correct methods of adjusting a regenerative receiving set, and it is accordingly hoped that a material reduction in the same way may be effected if the broadcast listeners can be persuaded to cooperate in an endeavor to clear the air of regenerative whistles, and, with this end in view, the following instructions for operating this class of receiving set have been drafted.

### WHAT IS REGENERATION?

THE principle of regeneration, as used in radio receiving sets, is that a part of the output of the detector vacuum tube feeds back into its own input and thus greatly increases the volume of the signal.

The electric waves reaching the receiving set from the transmitting station travel down the antenna wire through the primary coil in the set and so to earth down the ground wire. The weak electric current resulting from this influences the vacuum tube in such a way as to set it functioning.

The resulting output from the plate circuit of this tube is fed back in such a manner as to set up a "field," or "influence," in the part of the circuit connected to the input (the grid) of the tube. This "field" induces in the input circuit a current of electricity of the same frequency as that of the received electric waves. The energy, therefore, which comes down the antenna wire is automatically strengthened by an impulse from the output of the detector tube.

# NATIONAL Velvet Vernier DIAL

## Type B, Variable

(Patents Pending)

Positive Control  
Easily Mounted  
Gearless



Variable Ratio  
Velvety Smooth  
Graceful Design



With This NEW National Type B, Velvet Vernier Dial,  
*YOU* Control the Reduction Ratio!

**W**HAT a difference in the tuning of your set when you replace your plain dial with a new NATIONAL Type B Variable (patents pending). You'll be astonished.

Any ratio you desire, from a minimum of 6 to 1 to a maximum of 20 to 1 is instantly obtained by shifting a small lever. Note how it separates the stations operating on the lower wave lengths.

Easily mounted on the  $\frac{1}{4}$ " shaft of any standard type of variable condenser. The only tool you need is a screw driver.

The same velvety smoothness, the same freedom from backlash, the same mechanical drive as the famous Type A Velvet Vernier Dial, (patents pending). Price \$2.50.

### The NATIONAL KIT

for the popular circuits and hook-ups gives amazing results to amateur set-builders.

Comprises the NATIONAL CONDENSER and the wonderful BROWNING-DRAKE TRANSFORMER. Complete in one package, Price \$22. Makes a most welcome Christmas Gift.

Write for Bulletin 106 R. B.

**NATIONAL CO., INC.**

W. A. READY, *President*

110 Brookline St. CAMBRIDGE, MASS.



NATIONAL Tuning Unit  
Type B D-2

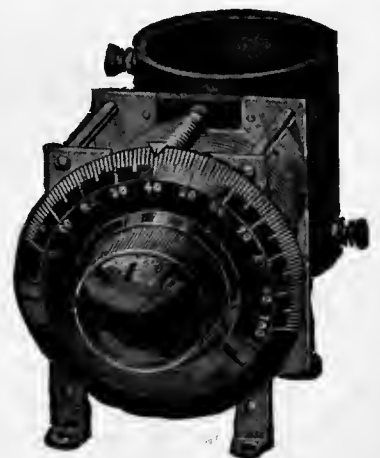

NATIONAL Tuning Unit  
Type B D-1



# ACME WIRE RADIO PRODUCTS

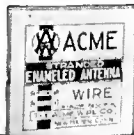

## Stranded Enameled Antenna

The best outdoor antenna you can put up. 7 strands of enameled copper wire; maximum surface for reception. Enameling prevents corrosion and consequent weak signals. 100, 150 or 200 ft. coils, boxed.



## Loop Antenna Wire

You can make a good loop with Acme wire made of 65 strands of fine copper wire, green silk covered. Flexible; non-stretching, neat.



## The Original Celatsite Wire

Celatsite is a tinned copper bus bar wire with a non-inflammable "spaghetti" insulation in five colors. Supplied in 30 inch lengths.

## Flexible Varnished "Spaghetti"

A perfect insulation tube for all danger points in set wiring. Costs little more and is worth a lot more than the cheaper substitutes offered. Black, yellow, red, green, brown; for wires No. 10 to No. 18. 30 inch lengths.

## Flexible Celatsite

Flexible stranded wire for "point to point" and sub-panel wiring—latest method of wiring sets. 5 colors, black, yellow, green, red and brown, one for each circuit. 25 foot coils.



## Celatsite Battery Cable

For connecting A and B Batteries (or current supply) to radio set. Silk braid covering 5 flexible Celatsite wires—5 feet long—a different color for each terminal. Prevents messy wiring and "blown" tubes. Adds greatly to the appearance of your set.

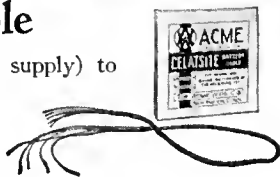

Send for Folder

THE ACME WIRE CO., Dept. B  
New Haven, Conn. ★

### WHAT IS OSCILLATION?

UNLESS controlled, this action will continue until the saturation point or climax is reached, the tube then being said to be in a state of oscillation. When a receiving set is in oscillation, it causes howling and squealing in your own and your neighbor's receiving sets. Regeneration should therefore never be allowed to proceed to this point as it then constitutes a public nuisance. On commercial receivers, regeneration is not always described by this name, and the dial which controls this feature of the equipment may be designated by any of the following terms: Regeneration; Reaction; Tickler; Feedback; Amplification; Varind; Sensitivity, etc.

When a radio receiving set in a state of oscillation is being tuned to a broadcast station:

- (1) It causes whistles in radio receiving sets, of all types, which are tuned to the same station. This interference may be heard up to a distance of several miles.
- (2) It distorts the quality of your own music.
- (3) It uses more B battery power and therefore the life of the B battery is reduced.
- (4) It tends to reduce the life of the detector tube.

When a radio receiving set, in a state of oscillation, is exactly tuned to a broadcast station, it is said to be in the state of zero beat. This distorts the broadcast reception and also interferes with neighboring receiving sets which are tuned to the same station.

In a word, regeneration carried to oscillation causes great annoyance to your neighbors, poor reception and expense to yourself, and has no advantages whatever.

### DOES YOUR RADIO RECEIVING SET CAUSE INTERFERENCE?

THE interfering whistle which you hear in your receiving set may originate in your own set or it may be interference caused by your neighbor. In order to determine this point you may make the following test:

Leave the regeneration control in a fixed position, slowly rotate the tuning dial, and note particularly the change in sound of the whistle. If the whistle rises and lowers in pitch sympathetically with the movement of your tuning dial it indicates that your receiving set is in a state of oscillation and probably causing interference to other sets. On the other hand, if the whistle does not change in pitch corresponding to each movement of your tuning dial, but simply varies in volume, the whistle is not caused by your receiving set, but is interference produced by some other oscillating receiving set in the neighborhood.

Many so-called non-radiating receivers will, under certain conditions, radiate and thus cause interference. Make it your business to see that your set is not causing trouble.

If you are in doubt as to whether your set can cause interference you can check the same by making the following test, but be careful to do so at a time when only a few people are listening in, so as not to cause annoyance:

Call a neighbor on the telephone and ask him to listen in on a particular station at a pre-arranged time and then tune your own set to the same station. Turn up your detector tube filament to normal and put the regeneration control to its maximum; move your tuning dial five times slowly across the point corresponding to the tuning of that station, then telephone your neighbor and ask him if he heard the interference corresponding to these five movements of the dial on your receiving set. If he heard your interference, the probability is that hundreds of others have also been annoyed at times by radiation from your receiving set. You should

## FROST-RADIO



TUBE ★  
CONTROL  
UNIT

\$1.75

(6, 25 or 35 ohms)

COMBINES Vernier Rheostat and Potentiometer. Single hole mounting. 6, 25 or 35 ohm rheostat, 400 Potentiometer. Genuine Moulded Bakelite.

List; \$1.75. Pacific Coast price slightly higher.



HERBERT H. FROST, Inc.  
314-324 WEST SUPERIOR STREET, CHICAGO  
New York City Cleveland Kansas City Los Angeles

22½ Volt  
un-acid  
everlasting  
rechargeable  
"B"

Storage Battery

\$2.95

includes  
chemical

45 volts \$5.25, 90 volts \$10.00, 112½ volts \$12.50, 135 volts \$14.75, 157½ volts \$16.80. Truly the biggest buy today. Easily charged on any current including 32 volt systems. Any special detector plate voltage had. Tested and approved by leading authorities such as Popular Radio laboratories. Over 3 years sold on a non-red tape 30 day trial offer with complete refund if not thoroughly satisfied. Further guaranteed 2 years. Knock-down kits at greater savings. Complete "Hawley" "B" Battery Charger \$2.75. Sample cell 35c. Order direct—send no money—simply pay the expressman cost on delivery. Or write for my free literature, testimonials and guarantee. Same day shipments.



B. Hawley Smith, 312 Washington Ave., Danbury, Conn.

# DIS-TON



Employs no fluids of any kind. Uses only one rectifying tube. Separate adjustment for detector and amplifier tubes. Handsomely finished in rich velvet-green Duco with solid walnut, satin finish top and bottom. Ample continuous "B" current for one to ten-tube sets.

## Remarkable Tone Quality — — Amazing Volume and Selectivity — *without "B" Batteries*

DIS-TON, in place of "B" Batteries, is guaranteed to improve the overall efficiency of your set. It provides constant "B" current at proper potential for your particular receiver circuit, tubes and loud speaker.\* DIS-TON is noiseless in operation—no crackles and popping such as you get with run down "B" Batteries—no hum of any kind to distort the finest aria or drown out the faint signals from distant stations.

### A self-contained electrical instrument using A C

DIS-TON is trouble free—the special Trans-Filter Unit is sealed in, protected against tampering and deterioration. It can't wear out. Consumes only eight watts from the nearest lamp socket and puts your "B" load on the big, powerful, carefully watched generators of your central station. You can rely upon DIS-TON to give you the best from your receiver.

Without attention of any kind after simple initial adjustment to your set—DIS-TON insures you the equivalent in performance of new "B" Batteries every time you listen in.

DIS-TON requires no change in the internal wiring of your set to secure either utmost efficiency or entire safety. Accidental improper connections can't result in tube "burn outs."

DIS-TON  
complete  
ready for  
operation  
110 volt, 60 cycle  
\$40.00  
Other voltages and  
cycles on application

### Know how much DIS-TON adds to radio

The advantages that DIS-TON will give you are outstanding and unusual. You have the opportunity to verify them all on your present receiver. A DIS-TON demonstration is yours for the asking. Send for Leaflet B and full details as the first step to greater radio enjoyment this season.

DIS-TON KITS  
Essential Parts  
for  
Home Builders  
110 volt, 60 cycle  
\$28.50  
Other voltages and  
cycles on application

## RADIO PRODUCTS, Inc.

Dept. RB

Richmond, Ind.

\*DIS-TON will not make a "single tube" into a "super-het," but it will modernize the performance of any of the good, older receivers in an amazing fashion.

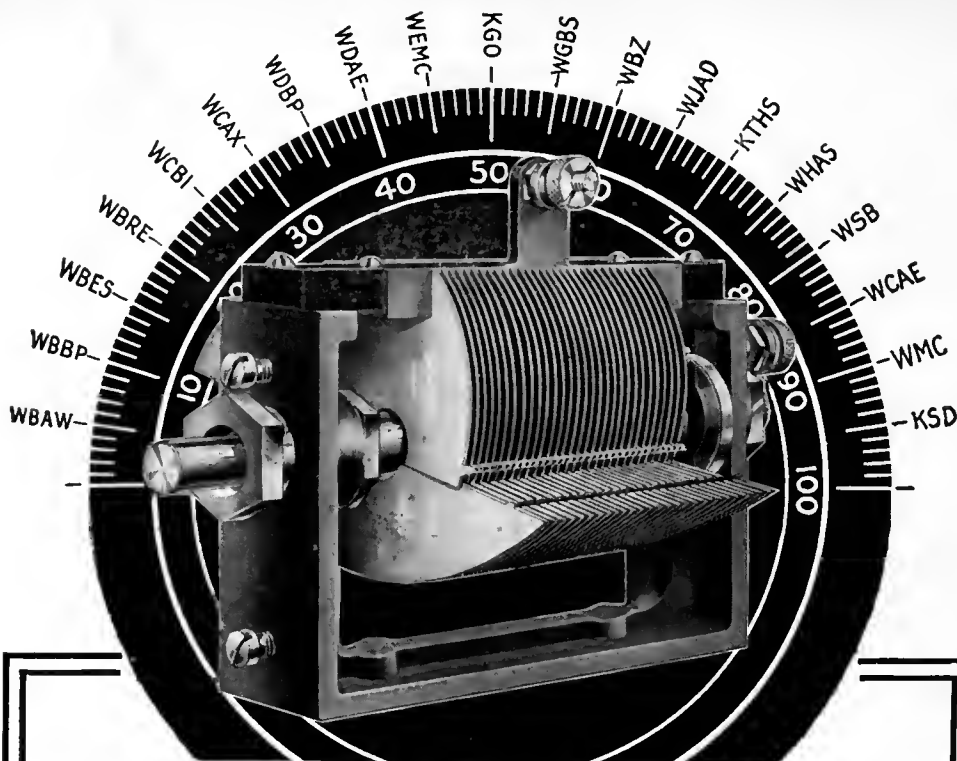

## Smallest Uniform Frequency Condenser Easily Fits Into Present Sets

**FULL** size illustration above shows Samson Condensers are but  $2\frac{1}{4}$ " diameter with plates fully extended—half to a third the size of others.

You can easily increase the selectivity of your present receiving set having ordinary condensers, and do away with the crowding of station readings—where 85 out of 100 come in below 50 on dial—by using

### Samson Uniform Frequency Condensers

Samson Uniform Frequency Condensers are built to a tolerance of  $1/1,000$  inch, silver plated all over for high surface conductivity, and—in addition—have gold plated rotor and stator plates to prevent oxidization.

These grounded rotor type instruments have losses lower than the average laboratory standards. This condenser, due to its design does not have the defects caused by either solid metal or dielectric end plates. 500 mmf., \$7.00; 350 mmf., \$6.75; 250 mmf., \$6.50.

#### SAMSON ELECTRIC COMPANY

Manufacturers Since 1882

Canton, Mass.

Sales Representatives in Thirty Leading American Cities



Why not subscribe to *Radio Broadcast*? By the year only \$4.00; or two years, \$6.00, saving \$2.40. Send direct to Doubleday, Page & Company, Garden City, New York.

## ACME CHARGERS

Best by Test ★

\$ 8.50 minus bulb

Your dealer can get it for you

THE ACME ELECTRIC & MFG. CO.

1410 Hamilton Avenue

Cleveland, O.

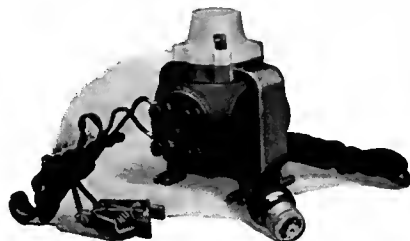

therefore learn how to operate without causing this interference.

#### ADJUSTING A REGENERATIVE SET

**I**F YOU will take the trouble to observe the rules which follow, you will obtain greater satisfaction and enjoyment from your radio receiving set, and at the same time cause minimum annoyance to your neighbors.

(1) Practise on tuning *powerful stations first* and do not try to pick up weak distant stations until you become expert.

(2) Use *both hands*, one hand for the regeneration control and the other hand for the tuning control.

(3) Keep the regeneration control always just *below* the point of oscillation, your set is then in the most sensitive condition. This is the reason for using your two hands for tuning.

(4) If your set then accidentally breaks into oscillation, turn *back* the regeneration control at once.

(5) Do not try to *find* a station by the *whistle*. If your set is tuned just below the whistling point, the signals will come in *clear* and your regeneration control can then be tuned a *little* further to increase the volume.

(6) Do not *force* regeneration in an attempt to obtain loud speaker volume from a set not designed for the purpose.

(7) Do not *force* regeneration in an attempt to hear stations beyond the range of your set; be content with those you can really hear.

The fact that you once heard a distant station on your receiving set is no indication that you can hear this station regularly, for occasionally a radio broadcast from a distant station is received with extra strength due to some freak condition. When you have tried to *tune-in* to a station in the correct manner for a *minute* or two and are not able to hear it, do not unduly increase your regeneration and persistently wiggle your dials, for in so doing you may be causing annoyance to some other broadcast listener who would otherwise be able to hear this distant station on his multi-tube set.

If you are not satisfied with the range your present receiver is giving you and providing local conditions are satisfactory, the only remedy is a more sensitive receiver or the addition of more tubes to your existing set. Don't at your neighbors' expense, try to force your receiver. Besides being unfair to your neighbors, you are also spoiling your own quality.

You can accordingly assist in eliminating these whistles by:

(a) Learning to operate correctly yourself.

(b) Not allowing children, who are not old enough to understand the correct method of operation, to cause interference from your set. (A crystal set causes no interference).

#### THE LICENSE

**A**LL radio receiving sets in Canada are required, by law, to be licensed. Licenses are issued yearly and are required to be renewed on the first of April each year. They may be obtained for one dollar from local Radio Inspectors, many Post Offices, many Radio Dealers, or from the Radio Branch, Department of Marine and Fisheries, Ottawa, Canada.

The proceeds of the license fees are used to maintain an inspection staff for the administration of radio and for the improvement of radio conditions in the Dominion.



For the benefit of listeners who are desirous of obtaining this article in circular form, it should be stated that copies may be had, on request, from the nearest Canadian Radio Inspector, or direct from the Radio Branch, Department of Marine and Fisheries, Ottawa, Ontario, Canada.



# AMPERITE

REG. U.S. PAT. OFF.

The "SELF-ADJUSTING" Rheostat

## A BASIC Need in Every Circuit

BECAUSE—AMPERITE not only modernizes any set—it keeps it modern.

- 1—Eliminates Hand Rheostats, thereby simplifying control.
- 2—Permits use of the latest types of tubes or any combination of tubes.
- 3—Simplifies and reduces set-wiring, thereby making for greater compactness and avoids losses.
- 4—No moving parts, hence no grinding noises; clear and full tones.
- 5—Prolongs tube-life by keeping filaments at a constant temperature.
- 6—No filament meters needed.
- 7—Brings the most out of each individual tube—automatically—no guessing.
- 8—Makes every set-owner a master operator, no knobs to turn.

Write today for  
**FREE**  
Hook-Ups

Sold Everywhere  
**\$1.10 complete with mounting**

AMPERITE is used in every popular present-day construction set. Why? Because of its many outstanding exclusive features, and because it solves the perplexing problem of tube-control—**COMPLETELY** and **AUTOMATICALLY**.

*For the new tubes:*

Amperite No. 112—for the UX-112 and CX-112  
Amperite No. 120—for the UX-120 and CX-120

*Radiall Company*

Dept. R.B.-13

50 Franklin Street

New York City

Mf's of "TUNE-RITE" Straight-Line-Frequency Dial

**Be sure that the set you buy or build is equipped with AMPERITE.**

# The Amplion Pedigree

Thirty-eight years ago—

**In 1887** Mr. Alfred Graham invented and demonstrated the first practical loud speaker which the world had ever heard (illustrated above).

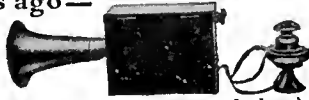

**In 1893** Graham Loud Speakers placed upon market. Illustration shows the "1893 model."



**In 1894** Graham Loud Speakers first used in British Navy. Graham transmitters applied to phonographs for loud speaker reproduction.

**In 1896** Graham Loud Speaking Naval Telephones developed and adopted by British Admiralty.

**In 1898** Graham Watertight Loud Speakers patented. Placed on many warships and mercantile vessels, throughout world.

**In 1902** Complete Graham Loud Speaker installations, on central battery plan, erected on warships as sole means of communication.

**In 1906** The most extensive loud speaking naval installation to date was made by Grahams. Included a Graham exchange system fitted to H. M. S. Dreadnought.



**Onwards** Graham Loud Speakers applied to all sorts and conditions of service at home and abroad, ashore and afloat.

**By 1919** No less than 12,000 Graham loud speaking installations in operation on ships alone.

**In 1920** (before radio loud speakers were in common use) "AMPLION" Loud Speakers produced for radio by Alfred Graham & Co. "AMPLION" trademark registered.



**In 1922** Amplions adopted as standard equipment by leading makers of radio sets abroad.



**In 1923** Amplions introduced into United States, Canada and other countries. Quickly attained largest throughout-the-world sale of any loud speakers.

**In 1924** To supply demand The Amplion Corporation of America was formed to market and manufacture Amplions here.

**In 1925** More Amplion companies formed and agents appointed throughout world to keep pace with international demand. The Amplion Corporation of Canada, Limited, organized.

Created by the actual originators and world's oldest makers of loud speakers, it is only logical that the Amplion should be unrivaled for clarity of tone. Some of the countries in which Amplions rule as favorites:

UNITED STATES  
CANADA  
ENGLAND  
SCOTLAND WALES  
IRELAND  
NORWAY SWEDEN  
DENMARK  
HOLLAND BELGIUM  
FRANCE SPAIN  
SWITZERLAND  
ITALY JAPAN  
SOUTH AFRICA  
NEW ZEALAND  
AUSTRALIA

The Amplion  
of 1926

# AMPLION



Alfred Graham & Co.,  
London, England  
Patentees

The World's Standard Loud Speaker

THE AMPLION CORPORATION OF AMERICA

Executive Offices: Suite L, 280 Madison Ave., New York City

Canadian Distributors: Burndept of Canada, Ltd., Toronto

To hear this new Amplion Dragon AR-19 is to appreciate why Amplions, year after year, internationally lead in sales. Six models, including phonograph units, \$12 to \$42.50. Write for interesting literature and dealer's address.

Associated Companies and Agents: Alfred Graham & Co., London, England; The Amplion Corporation of Canada, Limited, Toronto; Compagnie Francaise Amplion, Paris, France; Compagnie Continentale Amplion, Brussels, Belgium; Amalgamated Wireless (Australasia), Ltd., Sydney and Melbourne; British General Electric Company, Ltd., Johannesburg and Branches; Indian States and Eastern Agency, Bombay and Calcutta; C. J. Christie E. Hijo, Buenos Ayres; David Wallace & Co., Valparaiso; Mestre & Blatge, Rio de Janeiro; F. W. Hammond & Company, London and Tokio.

## WHAT OUR READERS WRITE US

Say "Pico" Instead of "Micro-Micro-Farad"

WHY not adopt and familiarize the prefix 'pico' for 'micromike?' wrote Mr. F. I. Anderson in the September RADIO BROADCAST (page 662). "Thus, instead of saying a 'triple-o-five' condenser, for an instrument of 500 micro-micro-farads, let us say 500 picos, which is correct and simple, if we once get used to it. To be precise, we should say pico-farads, but we could drop the farads once we get used to the pico end of it." From Robert S. Kruse, technical editor of *QST*, comes a letter informing us that he is heartily in agreement with this idea and has already taken steps to make it take on definite shape.

Editor, RADIO BROADCAST,  
Doubleday, Page & Company,  
Garden City, New York.

SIR:

I want to enter an enthusiastic endorsement of the idea expressed by Mr. F. I. Anderson on page 662 of your September issue. By a strange coincidence we received this issue on the exact day when we had been discussing the extremely unsatisfactory nature of the micro-micro-farad. This letter is only to offer you my personal cooperation in anything you would care to do along this line, although we have already half formed a plan of more general technical cooperation. This plan has now been submitted to our Executive Committee which is investigating its practicality.

Very truly yours,  
ROBERT S. KRUSE,  
Technical Editor, *QST*.

### Radio Developments in New Zealand

WE ARE always pleased to hear from our readers abroad and we think that fans in this country are interested to know what progress is being made in foreign parts too. There is a certain amount of satisfaction in knowing that one's local station is heard regularly in some remote spot of the globe, and perhaps a certain amount of chagrin when one reads that such and such a station may be heard very well, in New Zealand for example, while the native fan, who may be merely two or three thousand miles nearer, is unable to receive it. We wonder what percentage of East Coast fans have received KGO, KFI, and KPO, as often as Mr. Haggitt has?

DOMINION RADIO COMPANY  
WELLINGTON, NEW ZEALAND

Editor, RADIO BROADCAST,  
Doubleday, Page & Company,  
Garden City, New York.

SIR:

Just a few lines to express my appreciation of your excellent magazine. I have always found it an ideal publication in every way. I have just received the July issue and I think it is the best yet. I was very sorry to learn of the death of Miss Mix, as her column was of great interest to us. Broadcasting here is not of a very high order just yet, but this year will see New Zealand with one of the best broadcasting services in the world. Parliament is making provision this session for the erection of several main stations and several satellite relay stations. The revenue is derived from fees to be

This is a good time to subscribe for

RADIO BROADCAST

Through your dealer or direct, by the year only \$4.00

DOUBLEDAY, PAGE & CO.

GARDEN CITY, NEW YORK

## RADIO ANTENNA

TRADE MARK REG.

Above types in copper—tinned copper—enameled copper—tinned bronze.

Loop wires in silk or cotton covered.

Litz wires.

Enameled wires.

## RADIO WIRES

We manufacture all types.

Round braided antenna wires

Flat braided antenna wires

Round stranded antenna wires

Antenna supporting springs.

Cotton and silk covered wires for set wiring.

Write us for descriptive catalogue.

ROSS WIRE COMPANY

69 Bath St., Providence, R. I.

★ Tested and approved by RADIO BROADCAST ★



# Perfect Precision!

Radio technicians and engineers as well as seasoned amateurs know that "General Instrument" is satisfied with nothing short of *perfect precision*.

For example: The General Instrument laboratories developed the eccentric type straight line frequency condenser at great expense—only TO ABANDON IT!

Try to rotate an eccentric type straight line frequency condenser and note the effect on the bearing and then you will realize why "General Instrument" discontinued the eccentric type and created the CONCENTRIC straight line frequency condenser.

CONCENTRIC straight line variable condensers represent the latest development in condenser engineering. Observe the even distribution of weight of the rotor plate.



STATOR

"General Instrument" thinks more of its reputation than the cost involved in creating a perfect instrument. Hence—the CONCENTRIC straight line frequency condenser.

### CONCENTRIC Straight Line Frequency Condenser

(Pyrex Insulated)

The perfect instrument created by General Instrument. Type 80.



TYPE 40

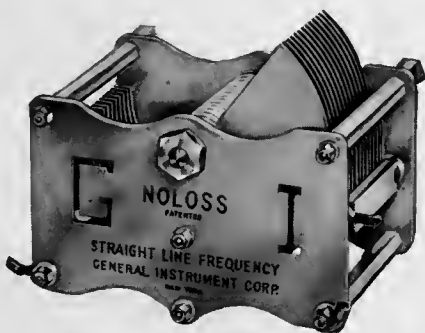

PATENTED

### THE INIMITABLE RHEOSTAT

Built only by General Instrument, this rheostat can NOT be imitated. To get it, you must make sure of the name "General Instrument."

OBTAINABLE AT BETTER CLASS RADIO DEPARTMENTS



**General Instrument Corporation**  
*Manufacturers of Laboratory Equipment*

423 Broome Street

New York City

★ Tested and approved by RADIO BROADCAST ★

# Superadio Receiver



Licensed Under Reactodyne Agreement

**5 Tubes**  
**2 Dials**  
**\$56**

At last—true beauty is combined with scientific design so that results never before expected are now easily achieved. Loose, extravagant claims are not made for this set, which must be seen and heard to be appreciated.

## Results Undreamed of Now Secured

Employs a radically new principle—inductive reaction. Housed in a handsome, compact, solid walnut cabinet with black bakelite panel engraved in deep gold—Produces full rounded tones with all their color and shading. Oscillations automatically controlled. Use of low loss S. L. F. Condensers and highly developed Solenoid R. F. Transformers results in tremendous power without disturbing squeals, while simple controls, only two, regulate the thunderous volume to fairylike whispers, if desired.

Send for circular giving engineering details why the Superadio is so far ahead of present day conceptions.

## Tested Tubes Now Possible With the Superadio Dynamometer

Remember—you can now buy TESTED tubes—where the Superadio Dynamometer is on the job. This meter is direct reading. Measures the amplification factor, plate impedance, and mutual conductance of any radio tube. Extremely easy to operate. Tests three tubes per minute.

Special Model S-2 Amplifier \$30.

### Jobbers and Dealers

Write for details on the Dynamometer, and our liberal selling proposition. Be the first in your town to sell TESTED tubes.



Superadio Dynamometer equipped with phones and plug. Price \$120. (Patents Pending)

## De WITT-La FRANCE CO., Inc.

54 Washburn Ave., Cambridge, Massachusetts

Boston Representative:

Martin, Hartley & Dewitt Sales Co., 99 Bedford St.

Chicago Representative:

William A. Welty & Co., 36 So. State St.

This is a good time to subscribe for  
**RADIO BROADCAST**  
Through your dealer or direct, by the year only \$4.00  
**DOUBLEDAY, PAGE & CO. GARDEN CITY, NEW YORK**

**3 Mexican Crystals**  
"The Catwhisker's Delight"  
The BEST, bar none. For Crystal sets, "Silver Galena." For Reflex sets, "Placerite."  
Once tried, always used.  
★ 40c Each, 3 for \$1.00  
Special for DeForest, 50c  
70,000 users. You are next.  
Dealers write  
**H. D. HATFIELD & SON**  
1762 Vermont Ave.  
Hollywood California

**FREE**  
Diagram for ultra-selective Crystal circuit free with 3 crystals at \$1.

### BROADCAST CONTROL OPERATORS

who read Carl Dreher's discussion in the September RADIO BROADCAST on "Microphone Placing in Studios," should not miss "Additional Notes on Microphone Placing" to be printed in the January magazine.

**RADIO CATALOG**

**DEALERS!**

Send for our big new live Catalog. Contains hundreds of standard nationally advertised sets, kits and parts.  
Use your letterhead

**Western Radio Co.**  
134-136 W. Lake St. Chicago, Ill.

charged listeners—in which will be the equivalent of nearly five dollars. At the present time my company is running the broadcasting stations in this city and local companies are doing the same in the other towns, but that will cease of course when the new Broadcasting Company (now in course of formation) is ready. The reception of American stations here is achieved nightly using only single "valve" sets, and loud speaker volume using one stage of radio, detector and two of audio. I have heard KGO, KPO, KFI, and others using a Kennedy Model XV Receiver and have logged any number of "Yanks" on a low loss set of my own construction. I am at the present time building a RADIO BROADCAST Phonograph receiver as described in your paper. I expect great results from it and no doubt you will be pleased to hear how I get on with it. This quarter of the globe is excellent for reception as is evident by the long distance records made by New Zealanders. At the time of writing we are expecting the arrival of the American Fleet here and I have already heard their "sigs." from Lieutenant Schnell's short wave set.

The "star" on your advertisements means a lot to us here in New Zealand. We cannot tell what is the latest apparatus and whether all the goods one sees advertised are what they are supposed to be, but in buying for this firm I have never once fallen in when guided by the "star." We have up to the present only handled small quantities of goods but we anticipate an increased volume of business this year. Thordarson, Belden, Na-ald, Peerless, Daven, Bell, Walnut, and Federal are amongst the lines we handle and we are satisfied that they are the best. So you can see what a valuable guide your paper is to us who "have no mother to guide us", as it were. We all enjoy your column "As The Broadcaster Sees It"—it is a scream.

Wishing you all the success you deserve with your excellent paper.

Very truly, yours,  
R. J. HAGGETT  
Wellington, New Zealand.

### The O'Connor Frequency-Changer

THE O'Connor Frequency-Changer, which was described fully in the June and August, 1925, RADIO BROADCAST, has caused much comment, and we have received numerous letters from readers who have had success with this circuit. By its use it is possible to convert any existing receiver to a super-heterodyne, and thus increase range and selectivity. Used in combination with a neutrodyne receiver it is possible to efficiently reduce the number of tuning controls to two, instead of the usual three. Here is a letter from an enthusiastic constructor.

Editor, RADIO BROADCAST  
Doubleday, Page & Company,  
Garden City, New York.

SIR:  
I have read with interest the controversy relative to the O'Connor Frequency-Changer, and as to its being a dud I can give evidence to the contrary.

I have one of the first ones made in this territory and what it did to my five-tube neutrodyne is more than satisfying, in selectivity and volume and distance, and I had what was considered an exceptional set before.

Atlantic City, Elgin, Providence, and Pittsburg come in between two degrees on the dial, and with no interference.

Detroit and Toronto come in within half a degree on the dial, also with no interference. I am getting Fort Worth nightly now, and practically all stations above 500 watts in power.

Very truly, yours,  
C. F. RODGERS,  
Conneaut, Ohio.

# Straight Frequency Line Tuning

Marks a new era in Radio progress—  
Sweeping country like a tornado—  
Fans welcome it with open arms—  
Irresistible demand growing by leaps and bounds—



## KARAS Started It — and KARAS Is Carrying On!!

When we sprung the Karas Orthometric Condenser on a restless, hungry radio public—we knew we had started something. But we scarcely expected to be snowed under with such a literal avalanche of orders.

We inaugurated Straight Frequency Line Tuning at the psychological moment. Radio Fandom was waiting hungrily for something new. And here was something—not only new—but so perfectly simple—so thoroughly scientific—so downright sensible, that everyone wanted KARAS Orthometric Condensers at once.

Our scheduled production was like a drop in the bucket. Buyers pleaded—cajoled—even threatened. Our plans were doubled, trebled, quadrupled. But it all took time.

KARAS Orthometric Condensers could not be thrown together. It took months to train gangs to build them with the absolute *precision* KARAS demands. So tens of thousands had to wait or buy other makes, hurriedly assembled to supply the demand we had created.

NOW—after months of preparation we are able to produce enough KARAS Orthometric Condensers to take care of at least a fair share of the demand. This announcement is an apology to those who were disappointed. A note of thanks to those who have waited. And a promise of revelation to those who have not yet discovered the marvelous advantages of Straight Frequency-Line Radio Tuning.

### How KARAS Orthometric Condensers Simplify the Tuning of any Radio Set

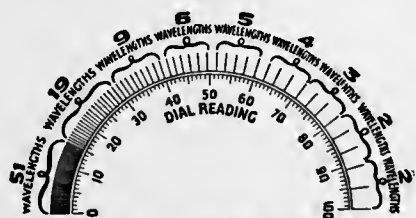

Ordinary Condenser Arrangement of Wavelengths

Ordinary straight capacity condensers crowd 70 of the 100 wave lengths into the first 30 points of the dial.

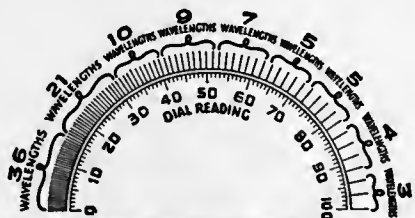

Straight Line Wavelength Condenser Arrangement

With straight-line-wavelength condensers 57 of the 100 wavelengths are crowded into the first 30 points on the dial.



KARAS ORTHOMETRIC CONDENSER Arrangement of Wavelengths on Dial

The New Scientific Karas Orthometric Condensers insure absolutely equal separation on the dial of all wavelengths throughout the entire broadcasting range.

#### Sizes and Prices—

- 23 plate, .0005 Mfd., \$7.00
- 17 plate, .00037 Mfd., 6.75
- 11 plate, .00025 Mfd., 6.50
- 5 plate, .0000972 Mfd., 6.50

Government regulations separate all stations by an equal interval of 10 kilocycles. Old type condensers—straight line capacity and straightline wavelength—warped this uniform arrangement—crowding a lot of low wavelength stations into the first few degrees on the dial. Difficulty in tuning—confused heterodyning interference—garbling of programs—these were the results. KARAS Orthometric Condensers give low wavelength stations the same equal separation as the high ones. It is the last word in making *real* selectivity possible. The illustrations above tell the story better than words.

Karas Orthometric Condensers are both theoretically, and mechanically perfect. Made entirely of brass—plates patent leveled and securely bridged to insure permanent rigidity and alignment. Every joint soldered. Grounded frame and rotor. Adjustable cone bearings. Spring copper pigtail. In short, so beautiful a job that one engineer, on seeing the condenser for the first time, smilingly inquired, "How many jewels?" As proof of their mechanical and electrical efficiency, Karas Orthometric Condensers will hold a charge for from 6 to 8 hours, as against one hour to an hour and fifteen minutes for ordinary condensers.

Note the long eccentric plates

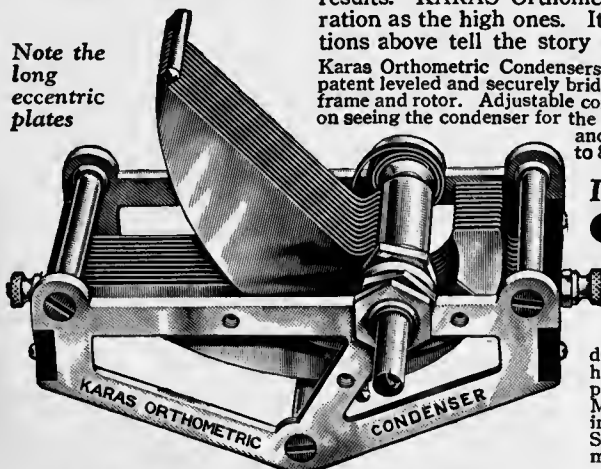

If your dealer hasn't secured a stock of Karas Condensers  
**Order on this Coupon!**

Most good dealers everywhere, sell Karas Orthometric Condensers. If your dealer happens to be one who hasn't secured them, we will supply you direct on our 30-day Money-Back Guarantee. Just fill in and mail this coupon at once. Send no money. Pay your postman on delivery.

Karas Electric Co.,  
4043 N. Rockwell St., Chicago

Please send me.....Karas Orthometric Con-

densers, size.....at \$.....each.  
I will pay the postman the list price, plus postage, on delivery. It is understood that I have the privilege of returning these condensers any time within 30 days if they do not prove entirely satisfactory, and you will refund my money at once.

Name.....

Address.....

Dealer's Name.....  
If you send cash with order, we'll send package postpaid

**KARAS ELECTRIC CO.,** 4043 North Rockwell Street  
CHICAGO, ILLINOIS

For more than 30 years makers of PRECISION Electrical Apparatus

# RADIO BROADCAST

ARTHUR H. LYNCH, Editor  
WILLIS K. WING, Associate Editor  
JOHN B. BRENNAN, Technical Editor

JANUARY, 1926  
Vol. VIII, No. 3

## CONTENTS

Cover Design	From a Painting by Fred J. Edgars	
Telephoning Photographs		Frontispiece
Ether Waves You Cannot Hear	James Stokley	295
Late News on the International Tests	Willis K. Wing	299
The March of Radio	J. H. Morecroft	300
What's New in Radio	Austin C. Lescarbourea	305
Better Audio Amplification	Kendall Clough	308
Notes on the Model 1926 Receiver	Ernest R. Pfaff	313
The Listeners' Point of View	John Wallace	317
A Universal Short-Wave Transmitter	Nicholas Hagemann	321
As the Broadcaster Sees It	Carl Dreher	326
"Radio Broadcast's" Universal Receiver	Arthur H. Lynch	332
"Radio Broadcast's" Booklet of Call Signals	Lawrence W. Corbett	337
Methods of Controlling Oscillation in Radio Frequency Circuits	John Bernard	350
If You Seek Economy, Buy the Best	Harold Jolliffe	360
"Now, I Have Found"		362
An A. C. Amplifier with the Roberts The Roberts Set with Cylindrical Coils A Home-Made Loud Speaker		
The Grid—Questions and Answers		376
Component Values for the "Aristocrat" Noises and Their Causes Impedance Amplifiers		
A Key to Recent Radio Articles	E. G. Shalkhauser	380
Book Review	J. H. Morecroft	388
"RADIO: BEAM AND BROADCAST"		
High-Speed Fading		392
What Our Readers Write Us		394

## BEHIND EDITORIAL SCENES

JAMES Stokley, who writes "Ether Waves You Cannot Hear" is an associate of Dr. Edward E. Slosson, the director of Science Service in Washington. Science Service is a most interesting and unusual organization, devoted to presenting in an able fashion the facts about science in any of its branches. The board of directors of the organization number some of the greatest scientists now living in America. For the benefit of those readers who do not know, Professor J. H. Morecroft whose "March of Radio" has appeared in RADIO BROADCAST ever since its first issue is a professor of electrical engineering at Columbia University, where he has trained many a radio engineer. Austin Lescarbourea, the writer of "What's New in Radio" was formerly Managing Editor of the *Scientific American*. He is now a free lance writer. Some interesting slants—as the baseball writers put it—on broadcasting are offered by the new conductor of "The Listeners' Point of View," John Wallace, whose first department appears in this number. The changes in call letters, and frequency of Canadian and American broadcastings stations during the past few months have been many and we have made every effort to have the list appearing on page 337 the most accurate to be found anywhere. Readers who have access to a razor blade and a pin can quite easily make up a sixteen-page booklet from the list.

Some misunderstanding has arisen about the description of a new N-P coil for the Roberts Knockout receiver printed on page 66 of RADIO BROADCAST for November. The author was Ralph D. Tygert, an engineer on the staff of the F. W. Sickles coil company at Springfield, Massachusetts. Mr. Tygert's findings have been incorporated in the new coils now being marketed by that company for the Knockout receiver.

OCTOBER and November have been the months of radio shows throughout the country; November especially was a red letter month in American radio affairs, for the third of Secretary Hoover's radio conferences was held in Washington and everyone agrees that the policies recommended for radio are most wise and calculated for the best interests of radio in this country. Too much credit can not be given to Mr. Hoover for his ability and foresight in causing the varied and sometimes sharply competitive interests of radio to settle their complex problems by amicable conference where reason has almost always prevailed.

MUCH activity is seen in the Laboratory these days. The staff is experimenting with three distinct receiver circuits, all of which have great merit and technical interest. If the receivers are proved worthy, each one will be described in an early number of the magazine. The Laboratory is collecting data on radio tubes and Keith Henney, director of the Laboratory, will have an article showing curves on all the popular tubes with a mass of highly valuable information for every radio user, which, as far as we know, has never been put together in one article before. The February number will also present "How Long Will My B Batteries Last?" by George C. Furness, an engineer who probably knows as much about radio batteries as anyone in the business. We shall also give the latest plans for the 1926 International Radio Broadcast Tests which will occur one week after the February magazine is on sale. Those Tests, by the way, give promise of being more interesting and successful than either of the two which have so far been held.—W. K. W.

### Doubleday, Page & Co. MAGAZINES

COUNTRY LIFE  
WORLD'S WORK  
GARDEN & HOME BUILDER  
RADIO BROADCAST  
SHORT STORIES  
EDUCATIONAL REVIEW  
LE PETIT JOURNAL  
EL ECO  
THE FRONTIER  
WEST

### Doubleday, Page & Co. BOOK SHOPS

NEW YORK: { LORD & TAYLOR BOOK SHOP  
PENNSYLVANIA TERMINAL (2 Shops)  
38 WALL ST.  
GRAND CENTRAL TERMINAL  
ST. LOUIS: { 223 NORTH 8TH STREET  
4914 MARYLAND AVENUE  
KANSAS CITY: { 920 GRAND AVENUE  
306 WEST 47TH STREET  
TOLEDO: LASALLE & KOCH  
CLEVELAND: HIGBEE CO.  
SPRINGFIELD, MASS.: MEEKINS, PACKARD & WHEAT

### Doubleday, Page & Co. OFFICES

GARDEN CITY, N. Y.  
NEW YORK: 120 WEST 32ND STREET  
BOSTON: PARK SQUARE BUILDING  
CHICAGO: PEOPLES GAS BUILDING  
SANTA BARBARA, CAL.  
LONDON: WM. HEINEMANN LTD.  
TORONTO: OXFORD UNIVERSITY PRESS

### Doubleday, Page & Co. OFFICERS

F. N. DOUBLEDAY, *President*  
A. W. PAGE, *Vice-President*  
NELSON DOUBLEDAY, *Vice-President*  
RUSSELL DOUBLEDAY, *Secretary*  
S. A. EVERITT, *Treasurer*  
JOHN J. HESSIAN, *Asst. Treasurer*

DOUBLEDAY, PAGE & COMPANY, Garden City, New York

Copyright, 1925, in the United States, Newfoundland, Great Britain, Canada, and other countries by Doubleday, Page & Company. All rights reserved.  
TERMS: \$4.00 a year; single copies 35 cents.

# Single Dial Tuning

## Yet Greater Selectivity



**The Wave Master Console**  
A beautiful genuine mahogany model with inbuilt horn.

**\$235.00**  
Also made in a handsome Console Model. Price **\$275.00**

*"NOW I Get What I Want When I Want It"*



**Standard Model 5-Tube Wave Master**  
in beautifully finished cabinet of solid genuine mahogany. Price, **\$125.00**

## KELLOGG Found the Way!

**H**ERE, at last, is a radio set that is REALLY easy to tune. Just one tuning dial—but what a magic dial it is! For it actually has a range of 540 degrees—over three times more station finding range than the ordinary dial.

A dial that gives lots of room for a wide separation of stations. Makes it easy to tune in the one you want and to completely blot out the others.

In fact, this remarkable new Kellogg receiver is exactly the set busy men and women everywhere have been asking for. A set that brings in what you want when you want it—without fussing, without "hushing" the rest of the family, without any need of knowing what is going on inside the handsome cabinet. Simply superb is the musical quality of WAVE MASTER reception. This masterpiece of receiving sets is the product of a manufacturing company that would naturally be expected to design a great set. For 28 years, the Kellogg Switchboard & Supply Company has been making precision electrical instruments—telephones, switchboards, and apparatus. Ever since the beginning of radio we have been making radio parts of highest

quality. But not until now have we been able to perfect a radio receiver that we felt was worthy to carry the Kellogg name.

The Kellogg WAVE MASTER has little in common with other five-tube sets. It operates on a new, better and more efficient principle. By using a new system of amplification and detection, we have solved the difficult problem of single dial tuning.

We have done it without any sacrifice of selectivity; instead, we have INCREASED selectivity as greatly as we have increased simplicity.

Would you know more about the WAVE MASTER? It is our aim to make it easy for folks to test the WAVE MASTER wherever they may be located—the country over. If you do not know the Kellogg dealer in your vicinity, write us at once for his name and a full description of the WAVE MASTER circuit. Ask for Folder No. 5-A.



**A Separate Circuit for Each 40 Meter Wavelength Band**  
*One-Dial Control, Yet Greater Selectivity.*

### Radio Dealers and Jobbers!

We are now closing sales franchises in open territory which is fast being taken up. The WAVE MASTER franchise, backed by Kellogg resources and our powerful advertising campaign is most valuable. Wire us if interested—or get into Chicago quickly and see us regarding this money-making proposition.

**Kellogg Switchboard & Supply Company**  
1066 West Adams Street, Chicago, Ill.

# KELLOGG WAVE MASTER SWITCHBOARD & SUPPLY CO.

IDENTIFICATION  
WANTED

13 IO 20  
20 I



N. Y. POLICE DEPT.

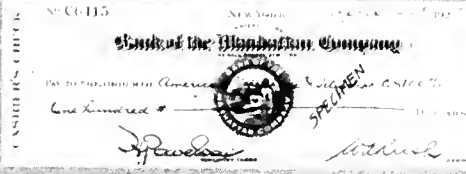

May 11 1915  
Margaret Collins  
Chief of Police Chicago, Ill.  
Instantaneous transmission of  
photographs and fingerprints by  
American Telephone and Telegraph  
Co. by wire, is a distinct and  
practical success  
Richard E. Ewing  
Police Commissioner  
New York

39 COMP NY CH

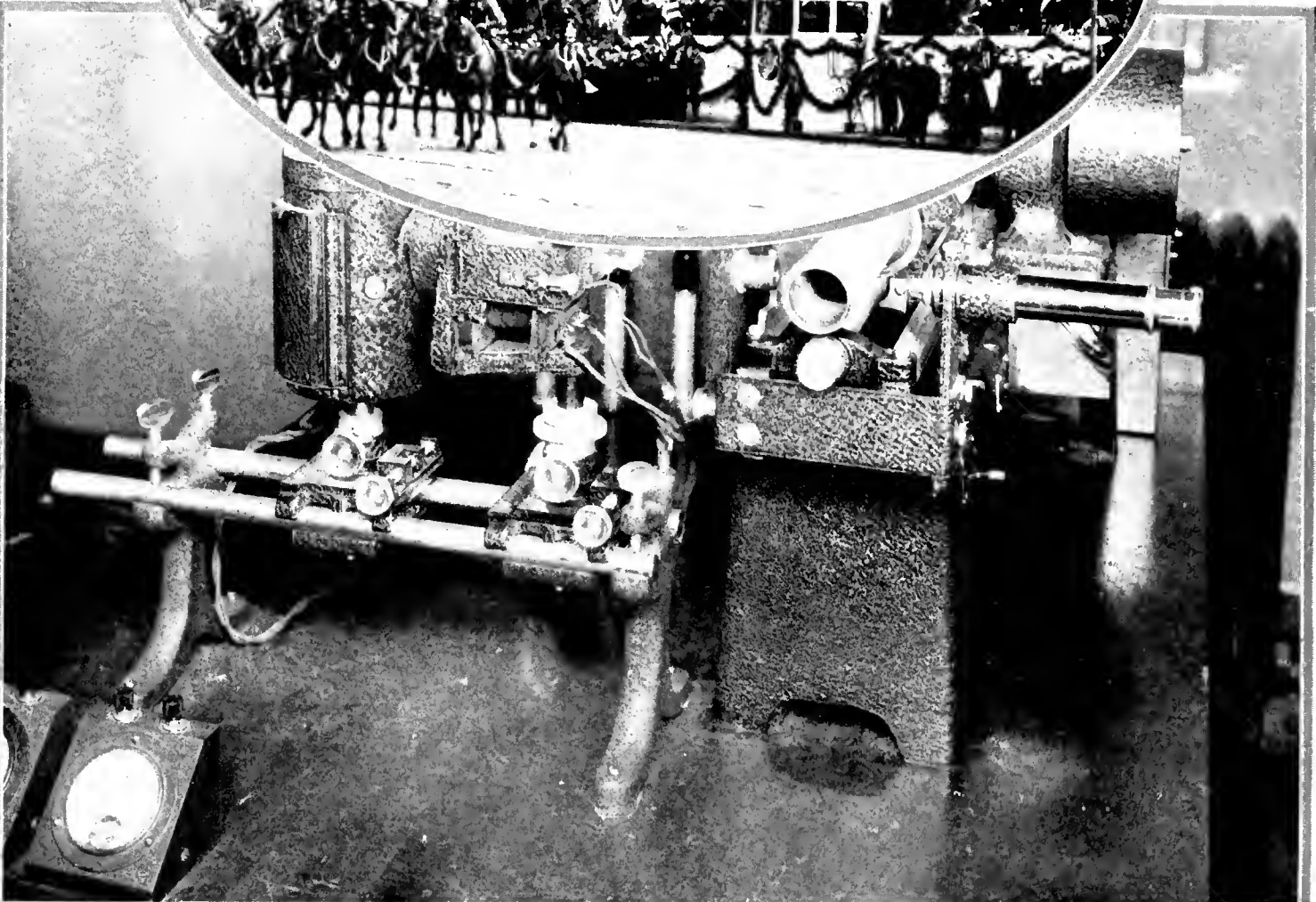
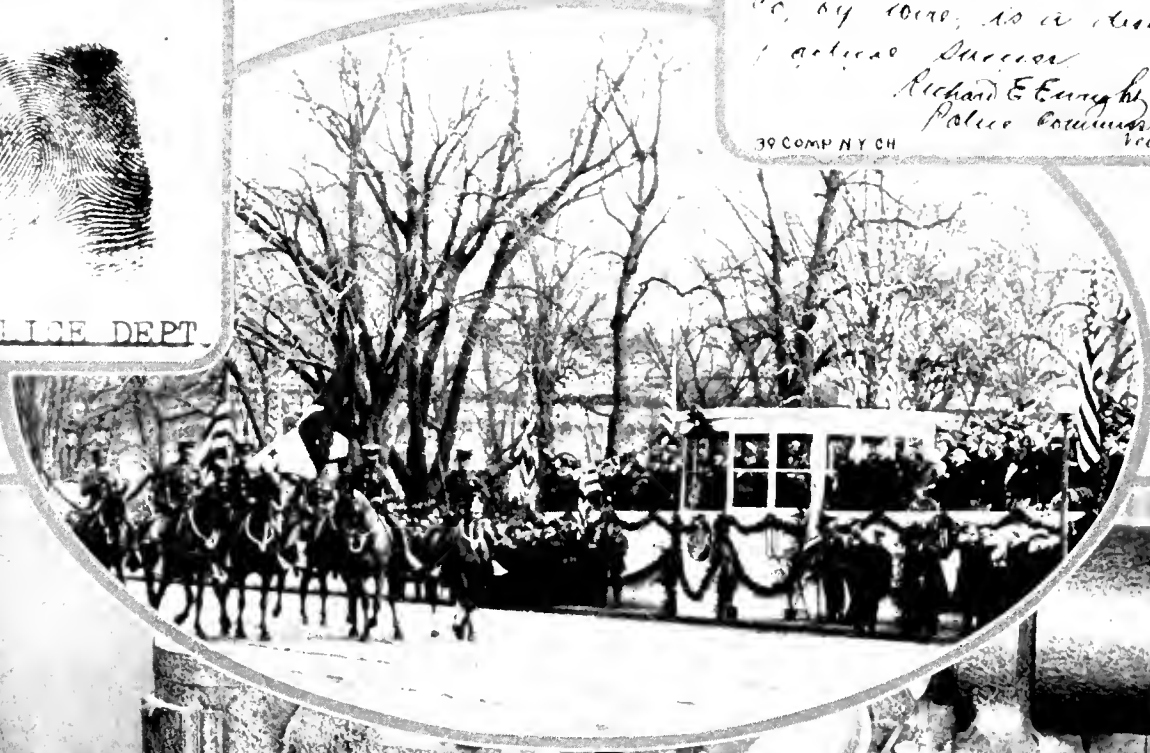

### HOW "TELEPHONED" PHOTOGRAPHS LOOK

Radio men have been interested in the announcement of the American Telephone & Telegraph Company of the successful sending of photographs by wire. The center oval shows a transmitted picture of the parade a President Coolidge's inaugural. Note the great detail preserved. Checks and business papers are frequently sent by wire. The check shown was sent from New York to Chicago in seven minutes. The finger print is shown upper left, as received in Chicago after it was sent from the files of the Police Department in New York to the Chicago police, for indentification, which was made and confirmed in three minutes after reception. Directly above is shown the picture receiving device. On the left is the lamp house, next the "light valve," operated by electric impulses received from the sender. The rolled unexposed film is shown on the drum in the foreground; behind it is the synchronous motor. When pictures are received, the room is kept dark. The only light on the receiving film is that which passes through the light valve

# RADIO BROADCAST

VOLUME VIII



NUMBER 3

JANUARY, 1926

## Ether Waves You Cannot Hear

The Few Isolated Facts Known About the Ultra Short Waves of Heat and Light—The Characteristics of X- and Radium Rays—Taking Photographs Through Dense Mists by Aid of Infra-Red Rays—How the Gap in Knowledge is Being Bridged Between Radio Waves and the Much Shorter Ones Familiar as Heat and Light

By JAMES STOKLEY

**M**OST radio enthusiasts are aware that when they listen to a broadcast concert or lecture, the ether is frequently full of commercial messages in code sent from ships or land stations, yet, in the best receiving sets, these are not heard because their wavelength is much greater than that to which the sets are tuned. Likewise short-wave transmission, using wavelengths down to a few meters, which has been so much discussed as making possible the sending of messages over great distances in daytime, does not affect the ordinary set, but requires a special one that is tuned to these waves.

Even a short-wave receiving set, however, will not make audible the multitude of still shorter waves that are continually fleeting through space, for radio waves are not the only kind of ether waves. Thousands of times shorter but otherwise identical with them, are the waves of light, and still shorter are the X-rays, and the rays of radium.

Thus there is a complete range of vibrations, all the way from those with waves whose lengths are measured by the millionths of an inch, to others whose waves are miles long. Some occur in nature, some are produced by man with his various pieces of scientific apparatus, and still others are yet to be produced. There are undiscovered gaps in the series which have not yet been filled, but

physicists and many other tireless workers in allied fields in many countries are busily engaged in closing these gaps, and making the series an unbroken one.

Most familiar to us, more familiar even than the radio waves, are those which make up visible light. The wavelengths of these are between  $\frac{1}{300000}$  and  $\frac{1}{650000}$  of an inch, the shortest making up violet light and the longest red. Between these are the wavelengths of the other colors, but longer than the longest red waves, and shorter than the shortest violet ones, are the waves which make up what is often referred to as "invisible light." Those that

are too long to see are called infra-red, and the short ones ultra-violet.

When a beam of white light is passed through a prism, the familiar rainbow-like spectrum is the result, a band of colors varying from red at one end to violet at the other. But the red and violet parts are not really the ends; the fact that they seem so is only because our eyes are not as sensitive as some scientific instruments. Take a radiometer, the little device consisting of small vanes, black on one side and silvered on the other, inside a glass bulb, which is often seen in an optician's window, and spins merrily when the sun shines on it. This is operated by the heat rays, and if it is placed a little beyond the red end of the spectrum, it will twirl, thus showing the presence of heat waves, which are identical with the infra-red.

On the other hand, if we allow the spectrum, and the part of it beyond the violet, to fall upon a photographic film, the most impression on the film will be made not by the yellow part of the spectrum, which appears brightest to the eye, but by the darker blue, and there will be a prominent image caused by the presence of the short waves called the ultra-violet.

In the realm of invisible light, things are not always what they seem. During the World War, several allied airplanes arose from their own lines bearing what was apparently an enemy insignia,



TWO EXAMPLES OF X-RAY TUBES

The largest and smallest ones made. These tubes have been invaluable for surgical work during the past few years. By placing the hand, in which, let us suppose, a piece of metal has become lodged, between the tube and a phosphorescent screen, the flesh will be found to cast a very faint shadow; the bones, a stronger one; while the embedded metal object will show a clear defined shadow

and they could easily have flown over the German lines without molestation from anti-aircraft guns. Neither did any of the allied soldiers attempt to capture the occupants of the planes when they landed, nor were any bombs dropped before the planes came down, for although to the unaided eye they bore a strange insignia it was transformed to the familiar design of an allied craft when observed through red color screens provided the allied observers. The enemy insignia was painted on the airplane in paint that reflected visible light, but that of the allies was painted with pigment that reflected its shape and form only in deep red light.

Even the secrets of the spheres are revealed through astronomical photography with invisible light. Last summer at the Mt. Wilson Observatory, in California, when Mars made a close approach to the earth, it was found possible for the first time to measure the extent of the planet's atmosphere, and indeed, to prove to a certainty that it has an atmosphere. These

pictures were made with the great 100-inch telescope, the largest in the world. Two sets were made, one by blue light, and the other by infra-red. Not only did the latter exposures show numerous markings on the planet, which were completely obscured in the blue set, but they also showed the diameter of the planet appreciably smaller! This, of course, is what we would expect if Mars had an atmosphere like the earth's. The blue light photographs could not penetrate the Martian layer of air, but the infra-red ones did, and enabled us to see the planet's surface.

This same principle also permits photographs to be made on the earth through great depths of atmosphere, and even through mists so dense that the human eye cannot see through them. Airplane photographs from great heights are made in this manner, and the special plates used reveal all the detail on the ground below. The photographer ordinarily uses a red light in his dark room because light of that color does not affect his sensitive emulsions, but

by bathing the plates before use in special dyes, they become sensitive to this part of the spectrum, and may be used with sufficiently fast shutter speeds to permit aerial photography with red, or even infra-red light.

The bathing beauties and the brave life guards browned by the sun have ultra-violet rays to thank for their coloration. For sunburn is largely due to light waves shorter than the visible spectrum. Babies are endangered when they lack this sort of light, for it is necessary to their health. One of the most important recent discoveries in the field of nutrition is that foods, such as milk and even lard, when exposed to ultra-violet rays, develop properties that prevent and cure rickets in animals and human beings.

The sun is the greatest and best ultra-violet ray machine we have. The sun is a great doctor. Mercury, vapor lamps can, of course, substitute for the sun, when days are dark or short. Moreover, there should be little or nothing between the sun and the patient for the most effective treatment



MODERN X-RAY APPARATUS

Which is due to the discoveries of Röntgen, in 1895, of certain rays called X- or Röntgen rays. These rays are invariably produced by the sudden stoppage of cathode rays by a solid obstacle. In modern X-ray tubes, the rays are as a rule allowed to impinge on a tungsten target placed in the center of the bulb. X-rays are then emitted only on the side of the bulb facing the tungsten. These Röntgen rays, like cathode Rays, excite fluorescence when they strike a suitable object. The exact nature of X-rays is still a matter of controversy, but most people now maintain that they are simply ultra-short light waves



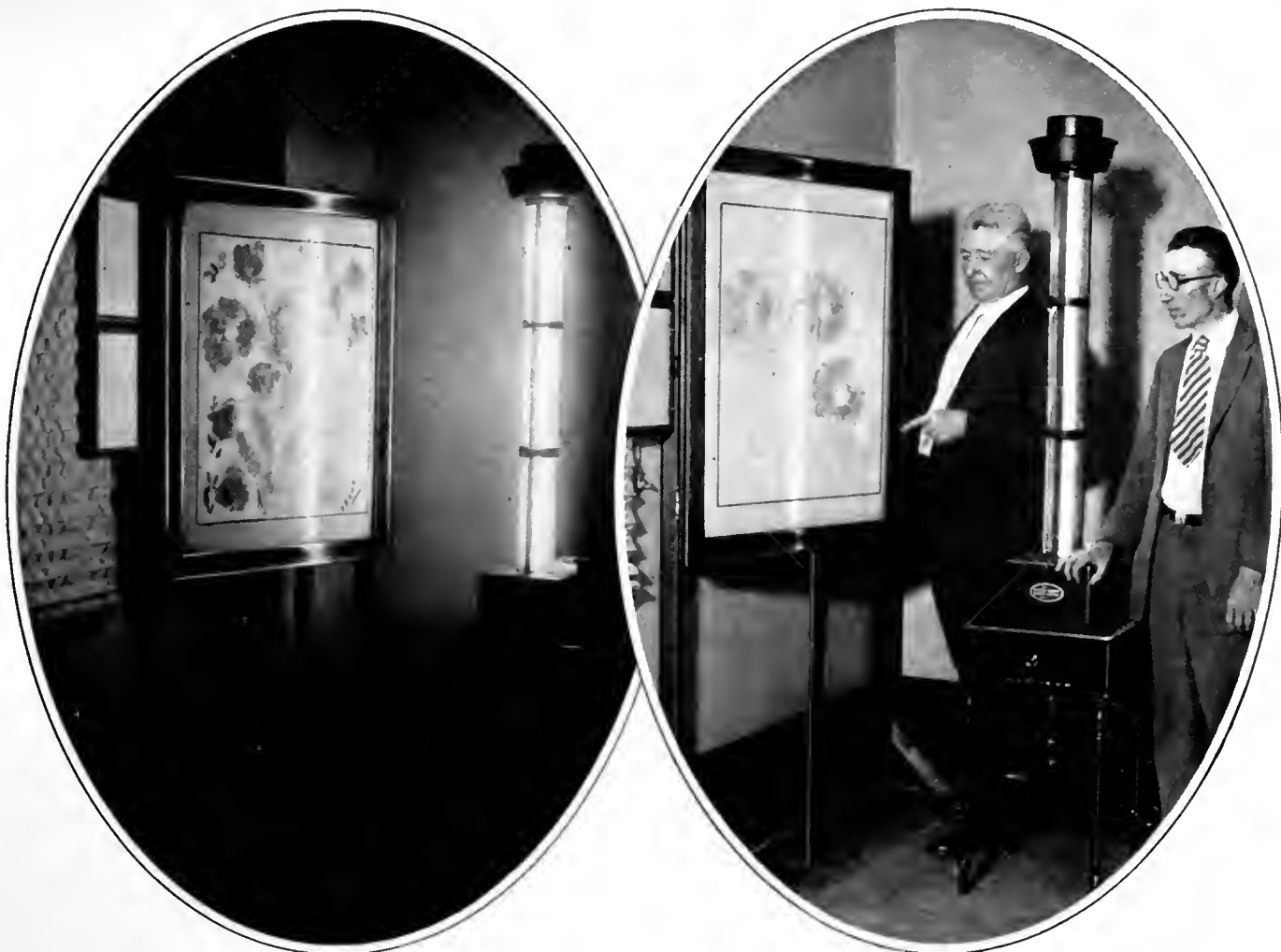

TWO EXHIBITS AT THE NATIONAL ACADEMY OF SCIENCES, WASHINGTON

To the left is shown an ultra-violet lamp which has been photographed by means of its own light. The photograph to the right shows another picture of this instrument. The mercury-vapor lamp, as it is termed, is rich in ultra-violet light

For most substances, glass among them, are opaque to these short rays. A sun bath behind a window pane would be ineffectual and for the same reason many violet-ray machines with lamps housed in glass, are valueless.

#### WHAT CAUSES LIGHT

**B**UT what causes light, or other ether waves, and how are they transmitted? Many years ago it was supposed that a luminous body gave off myriads of tiny particles, or "corpuscles," which traveled in straight lines, and when they entered the eye, produced a physiologic effect. This, however, gave way to the wave theory which is still held, though with some modifications. In studying light, one of the most useful instruments has been the spectroscope.

When light is passed through a prism and the proper combination of lenses, a band of colored light, the familiar spectrum, is the result, and if the prism and lenses are properly adjusted, there appears, when sunlight is being analyzed, a number of dark bands or lines which cross the spectrum at right angles. These were long ago shown to be due to incandescent gases, and by their use, astronomers have been able to tell what substances the sun contains, al-

most as well as if they had a piece of it in the laboratory to study.

Each element has certain lines in the spectrum. Thus many thousand are known for iron, while others do not have so many. Hydrogen has a number in various parts of the spectrum, and corresponding to the color, or wavelength of the part that they occupy. In 1885, Balmer found that a simple law would give the wavelengths of the lines of one of the series due to hydrogen. Since then, similar series have been found for other series of hydrogen lines, and also for other elements.

This, then, showed that there must be some order in the structure of these elements, but it is a different thing to find, by trial and error, a law that fits a series of cases, and to work out the reason that such a law is followed. But the talent was not lacking to find such a reason, and the best explanation, and the one that is most generally accepted by physicists, is that given by Prof. Niels Bohr, of Copenhagen, Denmark. It explains not only the series spectra of hydrogen, but also of the other elements for which such spectra have been determined.

According to the Bohr theory, the atom consists of electricity. At the center is a charge of positive electricity called the

proton, and around it revolve one or more negative charges, which the physicists calls electrons. These resemble the planets of the solar system, while the proton is similar, in its relative position, to the sun, around which the electrons revolve in definite orbits. But here is an important difference between the celestial and atomic cosmogony. While the planets in the sky always move in the same orbit, the electrons have the power of jumping from one orbit to another, and every time that such a change occurs, either visible or invisible light, or possibly one of the other forms of radiation, is given off.

The simplest atom is that of hydrogen, and thus it is understood why the spectral series of that element was first determined. Its atom consists of a single proton, or nucleus, around which revolves a single planetary electron. Every time the planetary electron changes its path, a radiation is given off. But, one asks, how is it that there are so many lines in the spectrum of hydrogen, when a single wavelength is given off with each change? As a matter of fact, if it were possible to isolate a single hydrogen atom, it would not radiate light of the entire hydrogen spectrum. But when there are a great number of atoms together, as there are in even the smallest

quantity of hydrogen that we can work with, there are so many that at any instant every possible change is going on in one or more atoms, and the combination produces the spectrum.

#### X-RAYS USED TO ANALYZE THE ATOM

WITH the shortest ultra violet waves about  $\frac{1}{500,000}$  of an inch in length, and the atoms so much smaller than that, it would seem hopeless to expect to study them by that means, but here the X-rays came into use. Much like lifting one's self with one's boot straps is this method, for the X-rays have been used to analyze the atom, and at the same time the study of the structure of matter has thrown light on the nature of the X-rays. In 1895, on the 8th of November, Prof. W. K. Röntgen, at Wurzburg, Ger-

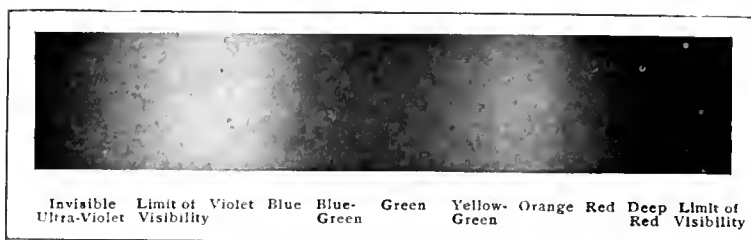

#### THE SOLAR SPECTRUM

As defined by the spectroscope and photographed on a sensitive plate. The ray to be analyzed is passed through a narrow slit before the prism. The slit tends to prevent overlapping of the various colors. Note that the photograph shows, at the violet end, a part of the spectrum beyond the limit of human visibility

between the lines is not very much greater than the wavelengths of the light waves themselves.

accepted ideas, consisted of molecules arranged in layer fashion.

Many facts previously observed made this theory of the structure of crystals the accepted one. When Laue passed X-rays through a crystal and found them deflected, the molecular layers themselves acting as a very fine grating, he investigated the nature of crystals and of X-rays at the

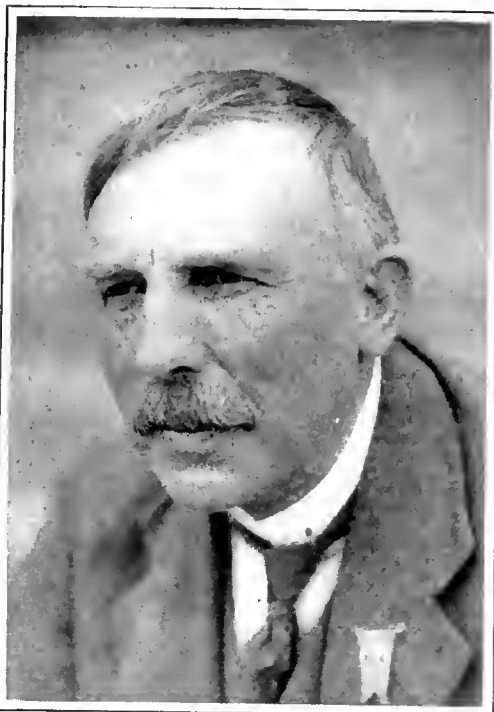

SIR ERNEST RUTHERFORD

An English physicist, born in New Zealand in 1871. He has been responsible for much developmental work in radio-activity, and published papers on the subject as early as 1904. He has done a lot of useful work in breaking up atoms by means of radium rays, and was awarded the much coveted Nobel Prize in 1908



#### A RADIOMETER

The device invented by Sir William Crookes to exhibit motion caused by action of light. It consists of a light horizontal vane formed of four metal discs, supported by cross arms at right angles, on an easily moving pivot. The whole is mounted in a highly exhausted glass bulb. The four metal discs are polished and blackened on alternate sides. If light rays are concentrated on the instrument, what little gas remains therein, is heated, and the discs are affected, the black ones becoming the hotter. The gas molecules acquire a greater velocity when flying off the black discs than they do off the bright ones, and the difference of velocity causes motion. The rate of rotation depends on the brightness of the light



PROFESSOR R. W. WOOD

Of Johns Hopkins University, Baltimore, who has interested himself in spectrology. While a Major in the United States Army (1917 to 1919), he developed a system of secret signalling, employing both visible and invisible light. One of his earlier inventions, curiously enough, can hardly be compared even remotely with his present work. It was a device for thawing frozen pipes by means of electricity

same time, and we now know the X-rays to be short waves, about  $\frac{1}{250,000}$  of an inch long.

Since then, Sir William Bragg, of the Royal Institution of London, and his son, W. L. Bragg, who is now professor of physics at the University of Manchester, England, collaborated on a remarkable piece of research, which in 1915 won for

many, discovered these rays which bear his name, and as their nature was not known, they were also called X-rays.

In 1912, however, another German scientist, Laue, found that by passing a beam of X-rays through a crystal they were deflected, in much the same way as a beam of light is deflected when it passes through a grating consisting of fine lines ruled on a glass plate, thousands to the inch. This effect is called "diffraction," and will only take place when the distance

them the Nobel prize in physics, probably the highest honor that can be given a scientist. They made an exhaustive study of the way crystals deflected X-rays, and from their results were able to deduce many facts about the very structure of the molecules of which the crystals were made.

Another Englishman, Sir Ernest Rutherford, also a Nobel prize winner, has since carried the work into the very heart of the atom. According to the Bohr theory, the atom consists of electrons revolving around a central nucleus, and if we could hit the nucleus hard enough, something should happen. This seems impossible, at first sight, because there is apparently no instrument small enough to get into the atom. Such a device would have to be as small as the atom itself, and as every kind of known matter is itself made of atoms, it is hard to imagine how we could knock an electron out of its orbit.

Here Sir Ernest made use of that wonderful element, radium, which is continually changing into another element. A small particle of radium constantly emits atoms of helium at a speed which would take them half way around the world in a single second. Actually, they cannot travel more

than a few centimeters, but by placing the material—he used nitrogen—the atoms of which it is desired to knock apart in close contact with the radium, the alpha particles, as the helium atoms are called, hit with a high velocity. They are so small themselves that they can enter the atom, and, when one hits the nucleus of an atom, its high speed can do a lot of damage.

This is not quite so easy to accomplish as it sounds however. Even in the most solid matter, the atoms are so spread out that, in proportion to size, there is as much empty space between the electrons and those of their neighbors as there is between the stars in the heavens. As there is no known way of aiming the alpha particles at the nucleus, the only possible procedure is to shoot a great many, by letting the radium act for a long time, and then waiting for an accidental hit. The process has been well compared with throwing keys at a door and waiting for one to lodge right in the keyhole.

But while the English scientists have been working on the problem, our American scientists have not been idle. Chief among those active in this branch of scientific research is Dr. Robert A. Millikan, of the

Norman Bridge Laboratory of the California Institute of Technology, at Pasadena, California. Within the past year, by means of what he calls high vacuum, hot spark spectrometry, he has been able to remove some of the electrons from an element and to detect the difference with the spectroscopist.

Although it represents probably the greatest achievement of physical science in recent years, the study of the atom and the forces within it, is barely beginning. Now we have but a glimmering of the time when atoms can be changed from one element to another at will, and when the tremendous forces that hold the atoms together can be utilized in our daily work. One difficulty has been suggested that may arise when this is accomplished. If we start the atoms disintegrating, will we be able to stop them, or will the disintegration continue until the entire world has been reduced to hydrogen, perhaps, and, like Icarus, our efforts result in our own annihilation? Whether this will happen cannot be foretold, but it seems likely that the physicists of the future who succeed in breaking up the elements at their pleasure, will not be without a means of controlling their efforts.

## LATE NEWS ON THE INTERNATIONAL TESTS

**P**LANS for the third International Radio Broadcast Test are progressing so rapidly that it is impossible to make a complete and accurate announcement in **RADIO BROADCAST** at this time because this is written about a month before the magazine appears on the newsstands. The last week in January, 1926, is the time fixed for the tests. American, Canadian, Mexican, and Cuban broadcasters will transmit from 10 to 11 P. M. Eastern Standard time beginning on the evening of January 24 (Sunday), and running throughout the week. English and Continental broadcast stations will be on the air during the same week from 11 to 12 P. M. Eastern Standard time.

Although the arrangements are not completed at the moment of going to press, it is probable that on Friday night, of that week, American listeners especially will have the opportunity of sharing in a most unusual broadcast experiment. During the first fifteen minutes of the American transmitting period, broadcasters in the Eastern time zone will broadcast while all other North American stations are silent. During the second fifteen minutes, stations in the central time zone will send, while all others are silent. And during the third fifteen-minute period, all the broadcasters in the mountain time belt will be on the air and every other station silent. During the last fifteen-minute period, the stations in the Pacific time belt will send out their programs under the same conditions.

It is expected that British and Continental stations will engage in a similar north and south broadcasting experiment during their transmitting hour on the next to the last night of the test. The transmissions for the first fifteen-minute period will begin with the English stations in the Greenwich Mean Time zone and progress across the Continent, if the present plans go through.

On the final night of the test, the British and Continental stations are expected to engage in a

### By WILLIS K. WING

north and south broadcasting test, which will be similar to the one in which the North American broadcasting stations will take part. The north and south schedule for American stations follows:

#### EASTERN STANDARD TIME

From 11 to 11:15 P. M., Canadian stations will transmit.

From 11:15 to 11:30 P. M., stations in the northern half of the United States will transmit.

From 11:30 to 11:45 P. M., stations in the southern half of the United States will transmit.

From 11:45 to 12 M., stations south of the United States will transmit.

This schedule will not only give American listeners a chance to hear stations in this country never heard before because of the station operating on a frequency used by some near-by station, but this arrangement will also give the overseas listeners a chance to pick up some American stations that are more distant from them than the stations almost on the edge of the Eastern seaboard. The arrangement of the American tests so that on the first night (Friday, American time) the stations will progressively transmit from east to west, and on the second night of those tests (Saturday, American time) transmit north and south, will give American listeners a chance to experiment with DX reception such as they have never before had.

The Continental and British stations, if they follow the same plan for their territory, on the last two nights of the test, will be on the air just one hour earlier than the American stations. This will keep the air clear for the American transmissions which follow. The British and Continental broadcasters will undoubtedly appreciate this arrangement, for it will give them a chance to get a bit more rest. Since the trans-

missions from abroad come at from three to four o'clock in the morning, London time, the physical strain on the various station staffs is bound to be quite heavy by the end of the test week.

The time chosen, which is a distinct hardship on the foreign broadcasters, is necessary because only during those hours is there a complete band of darkness clear across the Atlantic and as far as the Pacific coast of this country. It was hoped at one time, to interest the Australian broadcasters in joining the experiments, but the serious difference in time made that simply out of the question.

In every city of importance in the United States and Canada, one official "International Radio Week newspaper" will be chosen by the International Radio Week Committee. That paper will print the official, verified programs as transmitted from the overseas broadcasters. This will allow every listener to verify his reception the day after he has heard a foreign station. Newspapers throughout the country will carry frequent announcement of the latest development in the plans for the International Radio Broadcast Tests of 1926.

But if all those who had verified reports last year will send a description of their apparatus and something about the results they have with their receiver, to "International Radio Broadcast Test Committee, **RADIO BROADCAST** magazine, Garden City, New York" the Committee will pass on their equipment and wherever possible, appoint them as an official listening post for the Tests.

Results of successful reception can be sent to the Test Committee by mail, telegraph, and telephone. We can then verify reception. Reports of successful reception of the overseas stations can also be forwarded to the Test Committee by amateur radio. Station 2 GY, operated by **RADIO BROADCAST** Laboratory will be in continual operation and will receive and acknowledge all messages which outside listeners file with amateur radio stations in their home localities.



# THE MARCH OF RADIO

By *J. A. Morecroft*

Past President, Institute of Radio Engineers

## The Fascinating History of the Vacuum Tube

**A**BOUT a year ago the question of vacuum tube patents was discussed in these columns and the occasion was the expiration of the seventeen-year life of De Forest's "third electrode" patent. This patent of De Forest's, combined with the Fleming valve patent, completely tied up the vacuum tube industry for years, and during those years, six dollars was the price we had to pay for even the poorest type of tube. The De Forest patent had been acquired by the Radio Corporation and for years the price stayed where it had been put by De Forest when his output was measured in the hundreds and the cost of his hand made article was necessarily high.

The Radio Corporation had a complete monopoly of the manufacture of triodes and could fix the price as they chose. But in the last year or two with the rapidly expiring life of the De Forest patent, independently made tubes began to appear in large numbers and coincidentally, the price of RCA tubes began to fall to somewhere near a reasonable value. Whether the possible competition forced the RCA price down or whether it was purely an act of thoughtfulness for the good of the public on the part of this corporation, the broadcast listener can probably best judge. At any rate, we do know that when there

was no competition, the price remained very high.

Because of this very recent situation, we are somewhat perturbed to see that the "high vacuum" patent has finally been granted to Dr. Irving Langmuir of the General Electric Company—which means also the Radio Corporation of America. This basic patent has had a checkered career since the application was made in 1913. Almost allowed by the patent examiner at one time, and then withdrawn to permit interference proceedings in behalf of Arnold of the Bell Telephone Laboratories, the patent has been the subject of most exhaustive and expensive litigation. A decision by one authority in favor of Dr. Langmuir was nullified by a reverse decision by another and only during the last month has the patent been adjudged Langmuir's by the Court of Appeals of the District of Columbia.

This patent may prove to be so important in the development of radio apparatus that it well behooves us to know just what it is; and in deciding upon the possible effect of a renewed monopoly in the vacuum field we have only to remember that not longer ago than a year or two, companies making receiving sets were actually being sued by the Radio Corporation on the basis of their tube patents. The conten-

tion was that a radio receiver was evidently intended to be used with tubes and that therefore the set manufacturer should pay tribute, and turn in a percentage of his income to the Radio Corporation! The percentage was demanded not because he was making tubes but because he was making sets for which tubes were required!

In the half dozen years before 1912, vacuum tubes were obtainable only in the form manufactured by De Forest; modified small electric lamps is all they pretended to be. Their degree of vacuum was only as good as the commercially available methods permitted at that time. The tubes were far from uniform. One contained little gas and another had ten times as much, so that the performance of the tubes as detectors and amplifiers was erratic and unreliable. De Forest apparently didn't know why his wonderful devices were so variable in character, so that the ground was prepared for the procedure which started shortly after. It was not long before the Western Electric and General Electric Companies began to appreciate the significance of the De Forest audion, and to perceive its possibilities. Their research staff was put to work to find out why it was so variable and how to make the tubes more uniform. The American Telephone and Telegraph

Company was already using vacuum tubes as "repeaters" in its long distance lines and the General Electric Company had been for years greatly interested in vacuum devices so that both groups of research workers began intensive experimentation on the problem. The Western Electric engineers in their work of improving De Forest's relay (as they were using it) didn't consider their improvements in evacuation as anything really novel, although the improvement in the vacuum was the one thing De Forest's audion needed to change it from a toy to a reliable and most important piece of engineering apparatus. If a vote were taken to-day in one of our national societies of scientists as to whether the improvement in vacuum of De Forest tubes could be considered an invention, the result of the vote would undoubtedly be negative; the General Electric Company nevertheless had Langmuir apply for a patent on a *new kind of audion*. The patent claimed that the General Electric tube, evacuated better than De Forest's had been, was sufficiently novel and new to be patentable.

At first the American Telephone and

Telegraph engineers maintained (as would any reasonable scientist) that there was no patentable idea involved—that Langmuir had simply done a little bit better than De Forest had been doing for years. Langmuir contributed to the problem no really new ideas but simply brought the facilities of a great laboratory to help do the work De Forest's incompetent workmen had been trying their best to accomplish.

When it was finally decided by the patent office that these highly evacuated audions (given "Greco-Schenectady" names, to quote De Forest) actually constituted an invention, the American Telephone and Telegraph engineers started proceedings to show they had achieved the improvement of the vacuum first. Testimony was taken from the best scientists in England as well as America, the court was treated to elaborate laboratory demonstrations on the methods and results of getting high vacuum. Altogether the report of the proceedings covered some thousands of pages.

The upshot of the proceedings is now before us. The Government says that to

improve the evacuation of De Forest's audion does constitute a patentable idea and that the General Electric Company is entitled to the patent. This means, evidently, that every highly evacuated tube is subject to Langmuir's patent. But nowadays we use nothing but highly evacuated tubes so that we must conclude that every tube we have to-day is subject to this new Langmuir patent. This constitutes a most dangerous situation, one which the Radio Corporation of America can apparently freely use to their advantage if they desire. If we read the patent aright, it appears that now, and for the next seventeen years, all of our tubes are legally produced only by RCA so that the price is again at the mercy of this radio trust.

Possibly the RCA will not now push their advantage as they might have done had the patent been granted three years ago. The present Federal Trade Commission inquiry will probably effectually prevent the Radio Corporation from attempting crude monopoly. Seventeen years is a long time, and if the Radio Corporation lasts that long (a matter open to some doubt) it may still exert a strangle-

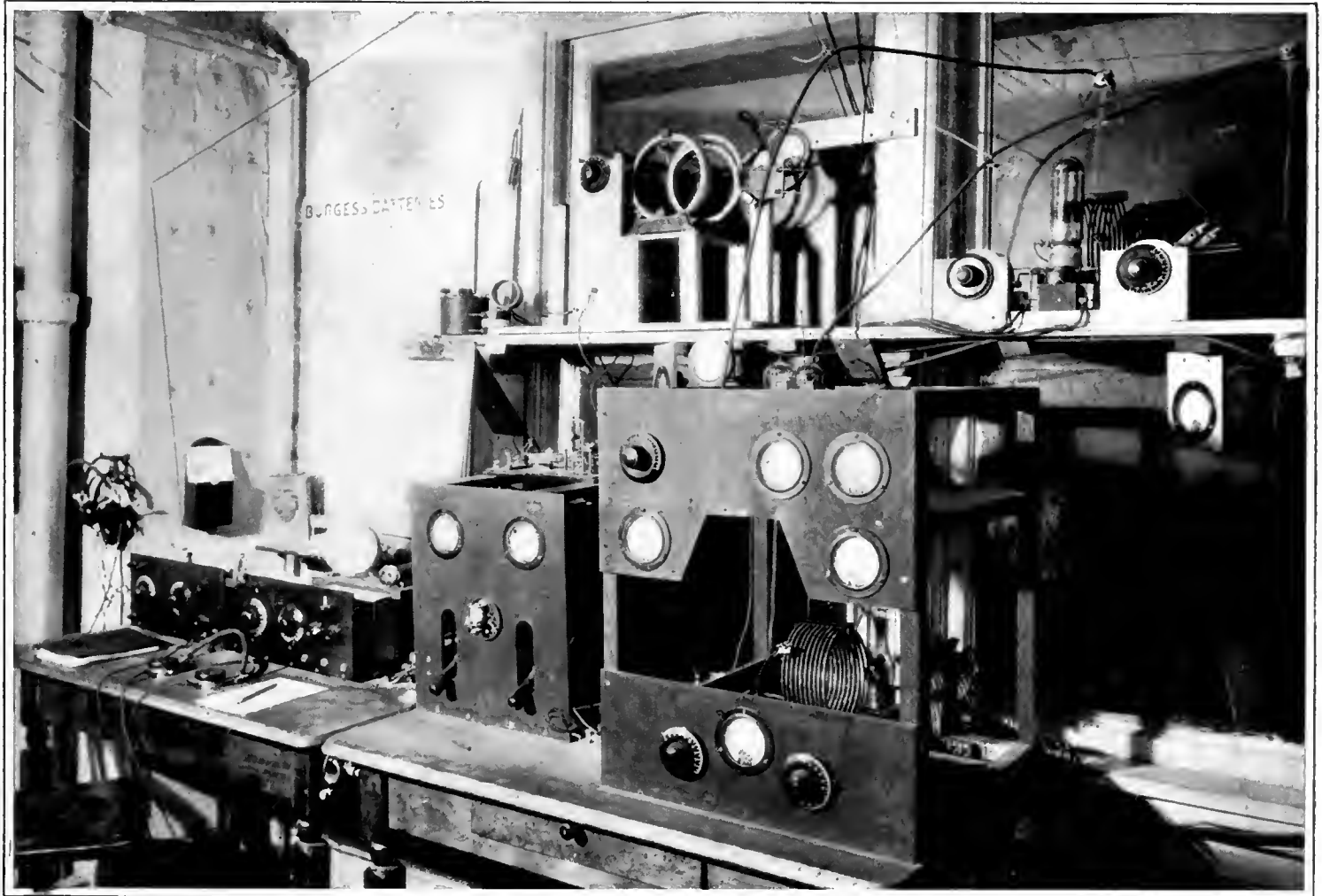

THE SHORT WAVE EXPERIMENTAL STATION

Of the Burgess Laboratories at Madison, Wisconsin, operating under the calls 9 EK and 9 XH. This elaborate station contains three distinct transmitters, one, in the immediate foreground operating on 3748 kc. (80 meters), another, directly above it tuned to 7496 kc. (40 meters), and a third, next to the 7496 kc. transmitter adjusted to 14,990 kc. (20 meters). A 70-foot telephone pole, three feet from the window shown at the right in this view, supports a rigid vertical antenna. The receiver at the left has a range of from 19,990-2998 kc. (15-100 meters). The next one to it works on 4997 kc. (60 meters). This is an example of a very well planned station, although it is considerably more elaborate than many successful amateur stations whose short wave signals bridge distances on the map as easily as a navigator does with a pair of dividers. One of the low powered transmitters here is operated entirely from heavy duty B batteries

hold on America's radio before the expiration of the life of this patent.

We believe that the Court was unfortunately advised in deciding that any man is entitled to a patent on the improvement in vacuum of a well known device. Unfortunately our opinion does not affect the legality of the situation. If Jones conceives a new and novel device and builds it to the best of his ability it appears that Smith may take one of Jones' devices and improve it by the help of better tools and thereby get a patent on it. Smith's patent represents no real inventive genius on his part but simply the application of better tools, which Jones would probably have used if he had access to them.

It may be that some legal step yet remains by which this threatened strangle hold of the Radio Corporation on the tube situation may be broken, but just what means are to be employed are not quite evident.

### Pure Science Becomes Practical

TO THE scientist it is most fascinating and gratifying to see the apparatus and phenomena which he studies as his life-work, coming to be of general service to mankind. And in the last few years, many are the cases in which this has come to pass.

Twenty-five years ago, most of the people who are broadcast listeners would have classed Richardson as a crazy visionary, not dangerous to be sure, but certainly unbalanced, when he dared to speak of *evaporating electricity from a hot metal*. Today the Radio Corporation makes millions of dollars each year in the utilization of this idea.

Ten years ago, some American and European investigators had to delve through ancient and unused textbooks to find out what was known regarding piezo electricity. The older textbooks said that if certain crystalline substances were properly squeezed, their surfaces developed electric charges; the amount of electricity which thus became available was so infinitesimal that engineers would have laughed at the idea of applying these crystals to useful service. Yet to-day these very piezo-electric crystals are being used in the broadcast stations to maintain the frequency constant. Furthermore this same piezo crystal has been found to be the most efficient

sound producer we have for sounds above the audible range. As a submarine detector these piezo-electric sound generators gave more promise than any other device, and intensive development was carried on during the war to push the piezo-electric detection scheme to completion.

Now another discovery from the realm



Radio Times, London

Householder (to departing burglar): "Er, would it be too much to ask you to take the loud speaker from the flat below?"



V. K. ZWORYKIN AND HIS THERMIONIC PHOTO-ELECTRIC TUBE

Which was recently developed at the research laboratories of the Westinghouse Company at Pittsburgh. The large illustration shows a special set-up to demonstrate the capabilities of the tube. A 75-watt bulb is at the extreme right; next to it is the photo-electric cell, which is really an improved vacuum tube, showering millions of electrons when light falls on an electrically sensitive substance, inside the tube. This light-sensitive substance in turn operates a relay. In the demonstration, the smoke of a cigarette, coming across the plane of the light caused a bell to ring, and the slightest shadow caused the cell to howl. The cell may be used to measure the light of the stars, through combination with a device developed by Dr. R. A. Millikan

of pure science promises to push itself into the purview of the layman. It has been known for years that if light, especially that toward the blue end of the spectrum, is allowed to fall on the fresh surface of such a metal as sodium, the surface being in vacuum, electrons will pull loose from the metal surface in some way by the action of the light waves. Small indeed was the amount of electricity thus set free, but to the scientist it was all important—as it allowed him to check his theories dealing with the constitution of matter. But now this photo-electric effect, as it is called, is to be used to check the stationary fireman to see how much smoke he sends up his chimneys.

The possibilities of the photo-electric cell have been realized for many years. Many experimenters in university laboratories have spent long hours of research and investigation to discover and formulate the laws governing its action. It has been used in talking movies to change light impulses into electric currents which could then be amplified by the vacuum tube amplifier. It remained for one of the Westinghouse engineers, V. K. Zworykin, however, to combine the photo-electric cell and the triode to make a more compact, and possibly more reliable, piece of apparatus. The electrons freed from the photo-electric cell in the tube are made to affect the potential of the grid of the tube and thus the plate current; this in turn opens or closes relays or performs other similar services.

As the light falling on the photo-electric surface varies, so does the plate current of

the triode; by arranging an incandescent lamp to throw its light on the sensitive surface of sodium, the smoke recording device became possible. The smoke, passing between the incandescent light and the sensitive surface of the photo-electric cell, perhaps one hundred feet away, cuts off part of the light, thus operating proper relays to record the event. At one of his demonstrations, Mr. Zworykin showed that if the smoke from a cigarette passed between the lamp and his sensitive cell the latter was sufficiently activated to cause the opening or closing of a switch.

### Short Waves Are Growing Shorter

THE daily press recently gave considerable space to an announcement of John Hays Hammond, Jr., that he had perfected a scheme for sending as many as eight radio messages on the same wave. The frequency of his carrier wave, 30,000 kilocycles, shows how short these short waves are becoming.

It is not evident that the Hammond transmitter has anything of real merit in it or that any new ideas are involved. Patents have apparently been granted on the method, but that indicates very little nowadays. To the best of our knowledge, Mr. Hammond has not yet explained the merits and new features of his scheme to any of the engineering societies, and we cannot help but feel that announcements of engineering accomplishments which are first divulged through the daily press instead of through the transactions of an engineering society, the members of which are able to judge its real merits and rate it



JOHN HAYES HAMMOND, JR.

With a bit of apparatus from his laboratory. Mr. Hammond, whose inventive talents are active in many fields beside radio, is probably best known for his secret system for radio control which several years ago was sold to the United States Government. The inventor recently sold certain rights on a directive and secret "broadcasting" system to the Italian Government. Many of Mr. Hammond's radio experiments have been carried on at Cruft Radio Laboratory at Harvard

at its proper worth are decidedly open to question.

A wireless dispatch to the New York Times from Berlin states that Professor Esau of Jena University has invented a wireless sender using a frequency so high that the wavelength is only two meters. It is reported that Professor Esau finds these very high frequency waves are not affected by the conditions which give absorption and fading on the longer waves and that he expects to telephone to America with his set "before Christmas."

Another report tells of experiments at the University of Iowa, in which wave-lengths of only 74 centimeters were used. Just what was done with these short waves, we do not know.

Before anyone else "invents" more of these short waves, we hurry to say that waves much shorter than any of these recently reported have been experimented with and measured years ago. Radio seems to be a field in which things are continually re-invented. At Columbia University, Professors Nicols and Webb years ago performed a number of striking experiments with short waves—really short ones. It is our recollection that they went as low as two centimeters, that is, about one inch. These waves were measured for length, were focused by mirrors and lenses, and reflected back and forth across the laboratory. Later Professor Nicols worked with waves much shorter, so short that his waves practically joined the spectrum of heat waves, which also are electro-magnetic.

If anyone else thinks of "inventing" some other short waves he had better look up scientific papers recording the work of earlier experimenters and then go back to the father of them all, Hertz. In his book on electric waves, Hertz describes practically all the phenomena which the recent inventors have been giving us. Some of these recent announcements of short wave "inventions" read almost like sections of Hertz's book; published thirty-five years ago.

### How Radio Has Improved

THREE general moves in the direction of improvement in the broadcast field we have consistently advocated and it is a pleasure to see them all coming to pass. The single-circuit regenerative receiver has come in for the universal condemnation it deserves and for which

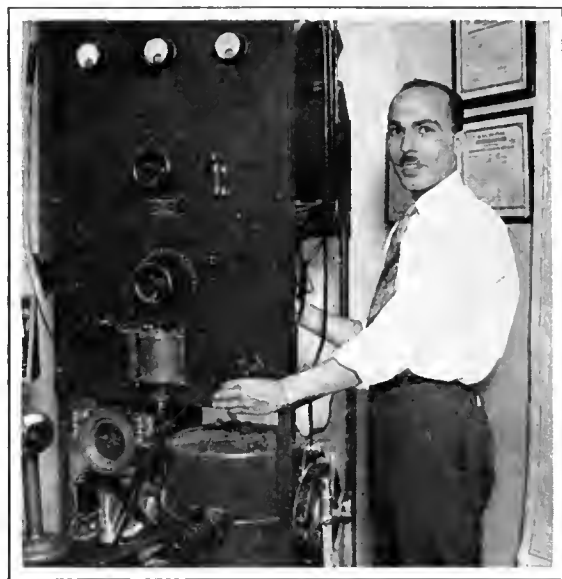

I. H. KORDI, EGYPTIAN RADIO ENGINEER Sent to the United States by King Fuad to study American radio methods. M. Kordi is shown inspecting a  $1\frac{1}{2}$  kw. arc telegraph transmitter at station WCG, New York

these columns called years ago. Improved quality of reproduction was the next general suggestion RADIO BROADCAST called for—hornless speakers, improved transformers, and power tubes for loud speaker operation. All of these are featured to-day in the best radio sets. Next we repeatedly called attention to the absurdity of continuing with batteries as the only source of power supply for radio sets. The crudest devices of the home use power from the light socket, yet radio outfits, the most scientific piece of apparatus the average home will ever have, continued with the crudest form of power supply. Only this year have the A and B batteries both been eliminated from any standard set and even now the price of such a set is absurdly high. The man with two hundred dollars to spend for radio, still has to depend upon batteries for his power, and how many times he runs into trouble as a result of this power supply! Dry batteries give out altogether, or become noisy; storage batteries call for a charging outfit and are troublesome to some listeners: all this time the light socket has unlimited power supply at negligible cost.

Commander Elmer Langworthy, U. S. N., who designed and built sets for the White House says, "About ninety-five per cent. of the trouble fans have with reception is due to their power supply." When called upon to diagnose reception troubles (for the President, we suppose) the Commander "usually finds dead or low low B batteries, defunct C batteries, and broken or loose battery leads." These troubles with the vexatious performances of the radio outfit, or no performance at all, will disappear when radio tinkering changes to radio engineering. An engineer depends upon batteries for power only when absolutely necessary, but in radio reception this is not so. The greatest need of the radio listener to-day, who is eager enough to get good quality without



WILLIAM DUBILIER

New York; Quoted in the British press on his recent European tour

*"Radio broadcasting is only four years old in America, yet the radio industry there is the sixth largest in America, and equals the automobile industry. The sales in America alone this year will be at least £100,000,000. As regards broadcasting, it may interest those who are continually criticizing broadcasting methods in Great Britain to know that in this connection you are in a much better position here than we are in America. The conditions in New York are intolerably worse than those of London. In my opinion, the British system is easily the better of the two. I am certain that good broadcasting is the key not only to international amity, but to world peace."*

further urging, is a reliable and reasonably cheap apparatus for supplying the power to his set from the light socket.

### The Month In Radio

EVER since the development of broadcasting on an important scale, the Commerce Department has been deluged with complaints from owners of radio sets relative to the great interference encountered from ship signals. Fans will be delighted to hear therefore that the Department of Commerce has agreed with British and Canadian authorities to prohibit the vessels of the three countries from using frequencies in the broadcast band when within 250 miles of the United States, Canada, or the British Isles.

ONE of the most famous American stations has outlived its usefulness and has been retired. After the outbreak of the war in Europe, all of Germany's communications to this country had to be carried out through their Sayville station on Long Island. Many an amateur listened-in on the dot and dash signals which went out over this channel—and so did Uncle Sam. Although United States officers were stationed there as censors, it was said that "contraband" messages were continually coming and going over Sayville's channel. We now know through an article in *World's Work* (Nov. 1925) that the famous Zimmerman telegram inviting Mexico to take

whatever of our Southwest territory she desired, with the additional suggestion that Japan join her, traveled by way of Sayville in one of its routes to Mexico City. When we entered the war, the station was, of course, taken over and the Navy has operated it ever since. Now it has been decided that Sayville's traffic can well be routed over other Navy channels. The famous Sayville station will now be held for reserve duty only.

THE Columbus (Ohio) *Dispatch*, has just issued a most interesting compilation of statistics for the radio dealers of that State.

All information of any value about prospective radio buyers is contained in the folder. How many buyers there are, percentage of male and female owners, number in family, character and earning capacity of the people in the different towns of Ohio, how many own automobiles, etc. We find the number of radio sets bought last year, number of radio dealers, number of clerks and employees, whether parts or sets satisfied the average buyer, whether the dealers serviced their sets and how it is done, how much advertising the radio trade does and where it is placed. This is the best piece of statistical work of value to radio manufacturers that we have seen.

THE Radio Corporation is in for a thorough airing. The Corporation will have to convince the Federal Trade Commission of their fair and just treatment of competitors and the radio public in general. There are one or two unsavory reports of the Corporation's activities still in our minds and it is to be hoped that no more will be brought to the light.

The companies being investigated by the Federal Trade Commission in addition to the Radio Corporation are The General Electric Company, American Telephone and Telegraph Company, Western Electric Company, Westinghouse Electric and Manufacturing Company, International Telegraph Company, the United Fruit Company, and the Wireless Specialty Company. The Federal Commission expects to bring out that a monopolistic trust exists in the radio field. It is possible they will prove such to be the fact. That isn't the thing that really counts, however; the question is, Has the trust (if such exists) been reasonable in the prices it has charged for its wares?

### Interesting Things Said Interestingly

HASKELL COFFIN (New York; artist): "Men have good color and they don't put anything on their faces. For youth to rouge and paint is just like gilding refined gold and losing the perfection and modesty of a sweet girl. A couple of glasses of cold water, a good walk in the park, or exercise in the morning by radio are a great deal more efficient in assisting beauty."

LORD GAINFORD (London; chairman of the British Broadcasting Company): "On a conservative basis it is estimated that ten millions of the inhabitants of these islands listen to our programs either regularly or occasionally. The peculiarly intimate character of this medium—the fact that the programs are received at the fireside—adds greatly to the burden of our responsibility. In a little more than two years, broadcasting has not only been established as a necessary part of the machinery of



DR. IRVING LANGMUIR

Schenectady; Research Engineer,  
General Electric Company

*"No branch of electrical engineering has had more interest for the physicist than radio. Hertzian waves, the vital element of radio, were discovered in a physical laboratory. Electrons, the discovery of another great physicist, J. J. Thompson, found their first engineering application in the form of a pure electron discharge in the hands of the radio engineer. Studies in the physical laboratory of phenomena in high vacuum, such as 'clean-up' effects of electron emission, of diffusion of one metal through another, of contact potential, and of other interesting physical phenomena, have all contributed to the development of the vacuum tube, which has been called the 'heart of the radio system.' 'Now, when a high stage of development has been reached in transmitting and receiving apparatus, the problems of the transmitting medium become more fascinating than ever. We are just beginning to understand the nature of the much-discussed Heaviside layer, and something of the polarization, reflection, absorption, and interference of radio waves."*

civilization, but it has come to exert a definite influence on the minds of the people. It is something that so far we have built this influence on definite ideals and standards of public service. But it is of greater importance that in future the medium of broadcasting should exercise no increasingly beneficent influence, and that nothing be done to endanger this influence."

DR. IAGO GALDSTON (New York; New York State Medical Society): "Five of the largest broadcasting stations in and near New York City are now cooperating with the Medical Society of the County of New York in its endeavor to present authentic health information to the public, to the extent of accepting voluntary supervision of all health talks going out over their wires. . . . There are still, however, certain agencies, both radio and journalistic which, to our great regret, have not closed their avenues of publicity to the insidious propaganda disseminated by persons whose ignorance of medical science is unbounded. They employ gross falsehoods daily in their attempts to discredit scientific medicine, and they advocate healing theories whose fallacies are largely veiled by the plausible manner in which they are presented. The medical profession has been unable to stem the flow of this propaganda."



# What's New in Radio

Many Interesting Refinements were Exhibited at the Fall Radio Shows, Which Started the Radio Season Off, But No Startling Developments Were Shown—Improved Quality Striven for by Nearly All—The Artistic Appearance of the Receiver Is Improving

By AUSTIN C. LESCARBOURA

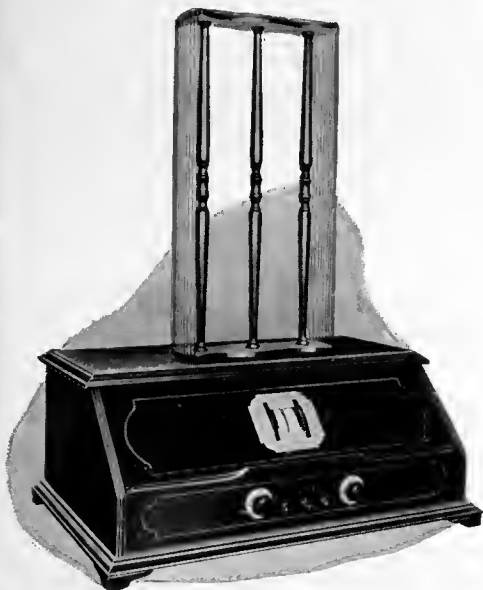

A SIX-TUBE SUPER-HETERODYNE

The second harmonic principle is embodied and a loop is used. While this type of receiver is not absolutely new, it has been redesigned and its appearance considerably enhanced. It is manufactured by the Radio Corporation of America



A FINE T. R. F. RECEIVER

Made by the Pathé Company. Such an instrument would not disgrace the appearance of any living room. The built-in loud speaker should gratify the most discriminating of tastes

TWO radio shows recently held in New York and those in other cities have served the usual ends. There has been the institutional round of handshaking, banquetting, chinning, praising, knocking, arguing, and agreeing—the social business of any gathering, radio or otherwise; and there has been the business of laying the radio cards on the table, in the form of new offerings to the radio public—the real, honest-to-goodness excuse for a radio show or exposition, and the very thing which attracts the crowds. These shows have well served as the national window display of the radio industry.

NO STARTLING CHANGES BUT NO END OF REFINEMENTS

THERE isn't a single genuinely startling change among this season's offerings—at least, if there is, it hasn't been exhibited at the radio shows thus far. Of refinements, however, there are many, indicating that radio engineers and manufacturers are keen to keep apace with the radio march of progress, devoting their attention to details when there are no prospects of immediate changes in fundamentals of radio reception.

Indeed, the whole atmosphere of this season's offerings is a happy one. Thus the fellow who bought a receiver a year or so ago, can feel happy in the assurance that he hasn't been "stung," because the same fundamentals that were included in his receiver are still being employed in the latest offerings. For the fellow who has waited until now, there is likewise much satisfaction; because, while the fundamentals may remain unchanged, there have been numerous refinements which go to produce greater selectivity, simpler operation, better tonal qualities and, in a few instances, more volume. For the manufacturer, too, there is much happiness in the stability of radio engineering. The more critical radio enthusiasts are bound to want the very latest refinements and will therefore purchase the new receivers, happy that these refinements have been made. So everyone is happy with the present state of affairs.

THE PRIME CONSIDERATION IS TONAL QUALITY

THE keynote of this season's offerings is tonal quality. A year ago, the general trend among radio receivers was toward sensitivity, selectivity, and volume; but to-day the prime consideration is tonal quality, which, like charity, begins at home with the radio receiver itself. In other words, the radio enthusiast now realizes that tonal quality is not a matter of trying one loud speaker after another, always in the fond hope that some day, somewhere, a suitable one will be discovered, which will produce the long desired realism. Distortion and poor tonal qualities originate in the radio receiver, and more particularly in the audio-frequency transformers and in the amplifying tubes. Poorly designed audio-frequency transformers fail to amplify with equal volume the wide range of audio frequencies.



THE CAMPBELLS ARE LISTENING: TRA LA, TRA LA!

An interesting photograph showing two instances of being all dressed up. The general trend at the recent radio exhibition was not toward anything revolutionary in design but rather toward improvement of existing models, both in general design and outward appearances. The receiver depicted is a Premier

Also, transformers constructed with poor quality of iron for their cores, are unable to keep up with the rapid magnetic changes caused by the audio frequency currents, with the result that the tonal qualities are blurred.

Until recently, the audio frequency end of



A NEW PARAGON RECEIVER

Of particularly handsome appearance. Its operation is quite simple, two main controls accomplishing the tuning. There is plenty of room in the cabinet for the inclusion of batteries

radio reception has been sadly neglected in the merry chase after new circuits. The audio-frequency transformers employed have often been the same as those originally intended for radio telegraph work, in which it is desirable to have a definite amplifying peak at 500 to 1000 cycles, so as to produce the utmost strength of signal at the usual audio frequencies employed in signaling. However, with radio telephony it is quite different. A flat amplifying curve, providing uniform amplification of signals from at least 100 to 8000 cycles, is absolutely essential if real tonal quality is to be had from the loud speaker.

So it is to be expected that this season's offerings stress the audio-frequency end. All sorts of queer terms are heard in this connection, such as acoustical synchronization, omni-tonal, ortho-sonic, polytonal and so on, which, reduced to plain English, mean improved audio-frequency amplification so as to produce loud speaker results comparable with those obtained from the simple crystal detector receiver and head set—the cheapest yet highest acoustic development in radio telephone reception! A glance at the working parts of the new offerings discloses larger audio-frequency transformers. In some instances, the transformers have been replaced by resistance-coupled stages of amplification; in other instances, the transformers are employed in conjunction with special by-pass condensers and special resistances designed to aid the tonal qualities.

#### THE HORN VS. THE HORNLESS LOUD SPEAKER

THE radio shows have indicated a decided swing in favor of the hornless loud speakers, although, truth to tell, the horn type still is in the majority in numbers by a very comfortable margin. The hornless type is represented by a number of exposed parchment cones, all more or less alike in design and mechanism; by an exposed cone of wood veneer—a very beautiful thing to gaze upon and presumably of excellent tonal qualities; and by enclosed or concealed parchment cones, which are provided with wooden cabinets or metal barrels.

With the present state of the radio acoustic art as applied to loud speaker horns, it is safe to say that the cone type of loud speaker has advantages which are not to be denied. However, the

last word has not been said in connection with the horn type of loud speaker, although the radio shows failed to promise anything startlingly new in that line. There are some interesting horns of moulded construction—veritable pretzels, designed to produce deep, mellow notes, yet fitting in a surprisingly small space.

Just what the latest loud speakers can or cannot do was not demonstrated at the radio shows. One cannot think about the early radio shows without recalling the bedlam of shrieks and groans and distorted music from hundreds of loud speakers all going at once. Fortunately, most radio shows to-day do not attempt to emulate the Tower of Babel, although it has always seemed to us that a radio show ought to demonstrate what a radio receiver can do. Individual sound-proof booths provided for the various exhibitors with something to demonstrate in the way of loud speaker performance, would solve this perplexing problem. However, at the Grand Central Palace exposition, excellent radio music was provided by Hewlett induction loud speakers, two of which were employed for the entire vast hall.

#### AND NOTHING NEW IN THE WAY OF HOOK-UPS

GETTING down to the real fundamentals of radio—the hook-ups—there is nothing new to report, so far as the present season's offerings are concerned. There is an overwhelming majority of receiving sets employing the five-tube radio-frequency layout, with two tubes for radio frequency, one for detector, and two for audio frequency amplification, and with the usual three tuning controls so much like the neutrodyne receiver that there is often some confusion in the lay mind. In some instances the number of controls have been reduced from three to two, and even to one, either with a single fixed means of tuning the circuits in combination, or with a fixed means and an optional means, so that each circuit may be tuned in combination or individually for maximum efficiency. In the simpler tuned radio frequency receivers, various means are employed to prevent regeneration.

Even though radio frequency receivers comprise the greater number of offerings, particularly in the low-priced group, this must not be taken to mean that this circuit is preferable to



#### SIMPLICITY OF CONTROL

Is the keynote of this Ferguson receiver. The two controls are for volume and sensitivity, while a numbered revolving dial behind the face of the panel enables one to write down the settings for the various stations

others. It should be remembered that the patent situation has no little influence on the choice of circuits by manufacturers, and that the regenerative, reflex, and super-heterodyne circuits are more or less dangerous ground to tread upon. As a matter of fact, a well designed three-tube regenerative receiver will usually do as well, if not better, than a five-tube radio frequency receiver, although its operation is more critical and is not so well suited to lay operation.

There is little change in the reflex circuit, as the original arrangement has been found quite satisfactory. The number of tubes for commercial reflex receivers is five or six, with two or three control dials. The reflex receivers are arranged for either antenna or loop operation. Some still employ the crystal detector, while others have gone to the tube detector which is simpler and more stable in its operation.

While the neutrodyne circuit remains basically the same, with the familiar three tuning dials, numerous refinements have taken place in producing the present season's neutrodyne receivers. The standard layout of five tubes has, in several instances, been increased to six, with the additional tube employed either in the radio frequency end or the audio frequency end. One neutrodyne receiver now employs three stages of tuned radio frequency, a detector, and two stages of audio frequency, with but two tuning controls. The antenna coupler tuning condenser operates on one tuning control, while the three remaining interstage condensers are ingeniously coupled together and operated by a single tuning control. The four radio frequency sections are individually shielded, to prevent the interplay of energy and to permit of increased voltage amplification. One neutrodyne manufacturer offers a six-tube set, with the extra tube used in the last stage of audio-frequency amplification, so as to have two tubes in parallel to handle the increased energy without distortion, even when employing standard vacuum tubes.

The regenerative circuit has all but disappeared in present offerings, being retained only in connection with the lowest-priced offerings.

The super-heterodyne is represented by just a few offerings. This circuit, in its highly developed commercial form, is now offered in two popular models, a six-tube receiver and an eight-tube receiver, both employing a decorative loop. Also, there is an elaborate decorative set containing an eight-tube super-heterodyne receiver and enclosed loop, together with concealed cone-type loud speaker and battery eliminator. This radio receiver, as it stands, is beyond doubt the greatest achievement so far scored in radio reception. Operating from the standard alternating current socket, without batteries of any kind, this radio receiver produces remarkable tonal quality in any volume from a mere whisper to a beautifully modulated output that will fill the largest hall. Antenna-operated receivers still lead by a big margin, despite the large number of loop type receivers.



#### NO A B OR C BATTERY

Is required for this receiver. It is connected directly to the house electric light socket—its only source of power. There is nothing unusual about the circuit itself, it being of standard radio frequency pattern. It is made by the Batteryless Radio Corporation, New York



A CABINET-MAKER'S BOOTH

Unless the trend in present day design was toward a more beautiful receiver outwardly, it is obvious that the above exhibitor would not waste time and money at the show. Now the public wants a good cabinet for the receiver

BATTERIES OR NO BATTERIES—THAT IS THE QUESTION

A VERY definite phase of this season's offerings, as reflected in the New York radio shows, is battery elimination. There are many offerings which have for their object the simplifying of storage battery operation, on the one hand, and the total elimination of batteries on the other. Some offerings are in the form of complete receivers with self-contained battery eliminators, but most of them are presented as accessories, intended for use with any receiver. Again, some offerings eliminate both A and B batteries, and even the C battery; but for the most part, merely the B battery is eliminated, because, after all, that is more readily achieved with satisfactory results than the elimination of the filament battery.

Due to ingenious methods of recharging the storage battery, this old-time radio device has received a brand new lease of life. This season's offerings include various combinations of storage battery and recharger, which do away with the usual storage battery. An interesting development is the trickle recharger, through the use of which a storage battery is constantly on charge at a very slow rate so that the current consumption is virtually negligible. Certain it is that these automatic storage battery outfits, if such they can be called, restore the storage battery in the good graces of the radio fan because of their steady output of current and their relatively low upkeep.

MORE AND BETTER TUBES THAN EVER

IT IS with keen satisfaction that we note the tube developments for the coming season. Instead of being limited to just a few types of tubes for the various purposes encountered in modern radio reception, the radio enthusiast now has a wide range of vacuum tubes to choose from. To the former standard tubes, now appearing with the new standardized base, there have been added power tubes for taking care of the last stage of amplification in storage-battery as well as dry-battery receivers. The growing use of battery eliminators and power amplifiers has also called for special tubes, such as rectifiers, ballast tubes, special power amplifier tubes and so on. To what extent the radio industry aims to give the very best it possesses, is exemplified in

the special vacuum tubes now available for resistance-coupled amplification. More and more it is coming to be recognized that the vacuum tube is part and parcel of a radio circuit, and must therefore be designed for the specific purpose intended. There is no such thing as a universal tube.

The A. C. tube has not as yet received wide recognition, although a few sets have been designed specifically for it.

THE IMPORTANCE OF LITTLE THINGS

IN LITTLE THINGS AS WELL

as big things, the keynote of the present radio season is improved reception. With no startling developments to monopolize attention, the radio engineers and the radio manufacturers have found time to concentrate on the numerous details of radio.

Even a hasty survey of radio parts and accessories discloses no end of refinement and improvement. Condensers have undergone marked changes, particularly toward the straight-line frequency type of plate, which prevents the crowding of radio stations at the lower end of the tuning dial. Sockets have been improved not only in mechanical details but also toward better insulation, with the former metal shell replaced by dielectric material. There is a definite trend toward broken-away bases, with the object of forming an air gap between plate and grid to reduce possible leakage.

And so it goes with all other parts, such as rheostats, potentiometers, plugs, jacks, fixed condensers, grid leaks, and binding posts. No radical changes, please understand, but plenty of evidence to prove that engineers and manufacturers have been hard at work.

LESS ACCESSORIES AND MORE SELF-CONTAINED RECEIVERS

THE order of the day, if we read the signs correctly, is a steady move toward self-contained receivers. More and more the radio manufacturers are coming round to the practice of a single cabinet with batteries, loud speaker, and, in some cases, wave interceptor, complete. Thus what were once accessories now become integral parts of the self-contained receiver, not only making for greater efficiency, since all components must obviously be better balanced in such an arrangement, but also making for remarkably attractive radio cabinets.

Then, too, there is a definite tendency toward beautiful appearance, with all signs of radio mechanism artfully submerged in the more advanced offerings. Thus the insulating panel with its dials, rheostat knobs and jacks, has been giving way to decorative wood fronts, with the radio controls artfully blended with the general decorative scheme so as to be inconspicuous. The standard tuning dial and knob have disappeared in many receivers, and in their place we have ingenious controls in the form of drums or rims which protrude through decorative slots; or, again, we have small knobs which control dials placed behind the panel, with just the immediate readings appearing through small windows. Some receivers have the tuning controls entirely concealed from view, until they are exposed by a drop front or other means.

Fortunately, however, this move toward camouflaged radio is devoid of freak effects. There are no radio receivers made to look like pianos or ice boxes or reading lamps. The move is a safe and sane one, which must go far to convince Milady that she should have the finest radio obtainable for that corner of the living room. It certainly makes things lots easier for us men who must sell the radio idea to Friend Wife!



BLACK BEAUTY

Is a title befitting the new Bosch Ambrorola receiver. The cone type loud speaker shown in this photograph, and exhibited at recent radio expositions, is the first of its kind to be made of wood

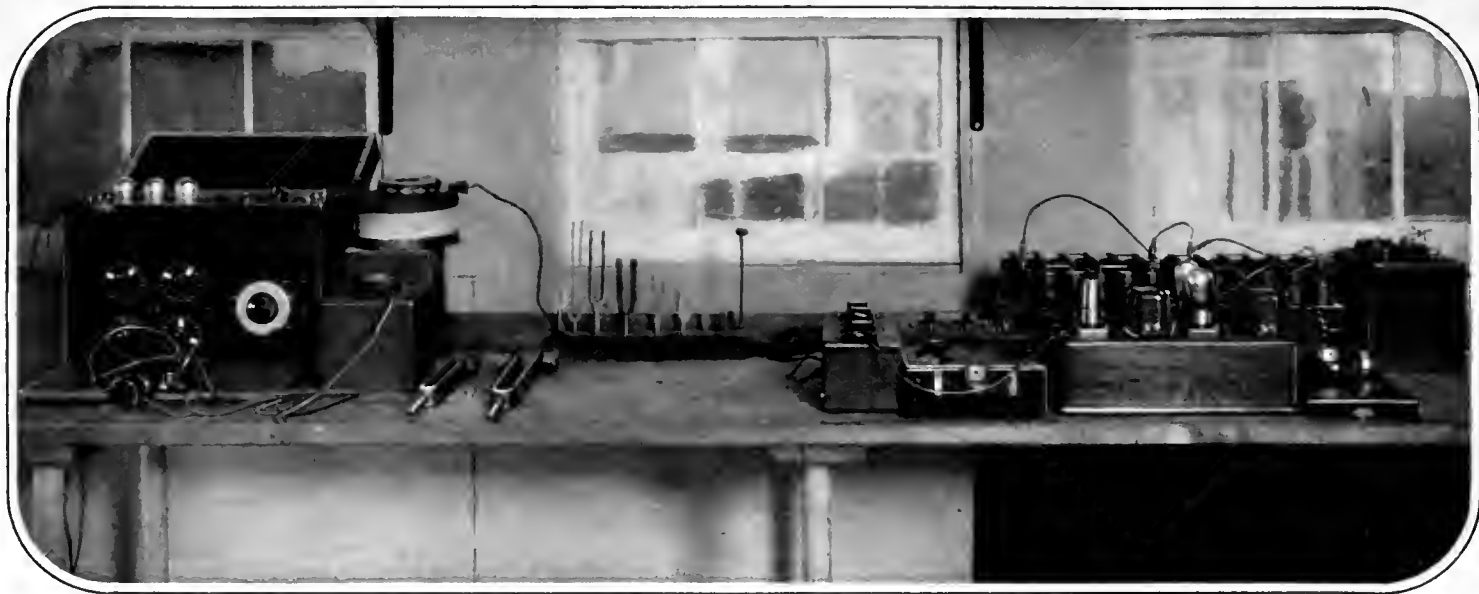

FIG. 1

The set-up of apparatus which is required to take accurate readings of audio transformer amplification over the audible frequencies. At the left is shown the audio oscillator which grinds out the signal whose frequency is known. In the center of the picture may be observed several sizes of tuning forks which, when struck, produce an audible signal whose frequency depends upon the mechanical make-up of the fork. At the right of the picture is the recording apparatus for measuring the degree of amplification of the audio transformer under test

# The Requirements for Better Audio Amplification

How to Tell a Good Transformer by Its Curve—Comparing Resistance and Transformer Coupling—The Right Tubes to Use

By KENDALL CLOUGH

*Research Engineer, Electrical Research Laboratories*

**I**N SPITE of the fact that the audio-frequency amplifier is one of the oldest units of radio and telephonic reception, it is still the subject of much controversy, and conflicting ideas are just as prevalent now as they ever were. The purchaser of coupling units for the audio amplifier is confronted with a variety of products to choose from, which are accompanied by as many different curves taken under as great a diversity of conditions. Then, after examination of the characteristic curves, he decides on a particular transformer, resistance unit, or choke, and installs it in his own receiver where it operates either to his pleasure or dissatisfaction.

There is just one sad thing about the whole affair and that is that he is usually satisfied with his arrangement, chiefly because the theory of the thing is right. The ear is rather untrustworthy to some minds and even though things may not sound just right, the unsophisticated listener is apt to recall the curves that he has seen on the device, or some particular theory that he has heard regarding it, and conclude that the theory must be right and that his ears

are wrong. As a consequence, too many of our homes are blessed with radio melodies of a nature that would make the composers as well as the artists blush with shame.

One of the first applications of the audio amplifier was its use in telephone systems for the amplification of the voice frequencies. In this capacity, it was considered necessary that the repeating devices used between tubes should handle with equal facility all frequencies between 200 and 2000 cycles per second. It has been recognized that the transmission of music requires a still greater frequency range, but how much greater, the manufacturers' curves do not seem to agree. It seems that, to date, few of them have considered the performance of their transformer or other devices below 100 cycles per second, and in some cases not that low. On the upper range, we see some carrying their curves up to 3000 cycles and some to as high as 8000 or 10,000 cycles.

The chart shown in Fig. 2 may shed a little light as to how great this frequency range actually should be. Here the piano keyboard is shown in full lines corresponding to actuality, while an additional oc-

tave, which will be discussed later is shown dotted. The heavy lines opposite the names of the various instruments are indicative of their frequency ranges.

The important point of this chart is the fact that the piano notes involve frequencies as low as 30 cycles. In addition, such instruments as the bass viol and the tuba have their entire ranges in the lower frequencies thus making it imperative that the audio amplifier be capable of magnifying such frequencies if it is to be properly designed. There are a few instruments, such as certain kettle drums and organ pipes, that sound at frequencies lower than those shown on the chart, but these notes are so exceptional that it is hardly necessary to consider them for the average broadcast program.

In the upper range of frequencies, the piano continues to represent the extreme, having a frequency of more than 4000 cycles at the highest note. It might appear on first thought that it would be unnecessary to measure amplification at higher frequencies, although, as mentioned previously, some transformers will amplify efficiently at considerably higher frequencies.

It is a fact well known to musicians and physicists that when an orchestral instrument is sounded, there is emitted, not only the fundamental note, but also frequencies of double, triple, etc., the frequency of the fundamental. These are ordinarily called overtones by the musicians, and harmonics by engineers. For example, suppose that the note C, frequency 256, is struck on the piano. Frequencies of 512, 1024, 2048, etc., together with combinations of these frequencies, will be present in the resultant note. In general, the intensity of these overtones will decrease in the order named, but for a given instrument they will bear a definite amplitude relative to the fundamental note played. It is the number and intensity of these harmonics that enable the ear to distinguish between the violin and the piano playing the same note. These harmonics aid the highly trained ear to tell the Stradivarius violin from others. In other words, the harmonics and their relative intensities determine the tone quality or color of the individual note. Experience has shown that in order to retain with fidelity the characteristics of the upper notes that at least one harmonic must be provided for in the design of the amplifier. For that reason we will need to consider certain notes that are not actually on the piano keyboard although they are heard. They are shown in the chart by the dotted line portion and by the notes of the staff above.

So the first point that we will want to assure ourselves of in the purchase of amplifying devices is that the characteristic is desirable from 32 to 8192 cycles or more.

WHAT CURVES AND CHARTS MEAN

THERE is a considerable variation in the appearance of response curves according to the type of coordinate paper that is used in plotting the results of tests, so that it is well when reviewing curves to note what type of paper is used. To illustrate this point, curves on two different transformers have been plotted on three different scales, such as have been used by various firms. The full line in each chart is the characteristic of a very good audio transformer while the dotted line represents a poor instrument. It will be noted immediately that there is very little apparent difference between the two as plotted in Fig. 3a while a decided difference is shown in Figs. 3b and 3c. The first curve is plotted in the usual regular coordinates and the third in what is called logarithmic scale. The second, Fig. 3b, is a combination of the two, frequencies being plotted on the logarithmic scale and the response or amplification in regular scale.

There can be no doubt but that the scale of frequencies should be plotted in logarithmic scale. The "C's" of the musical scale have been marked off on the three charts to show the absurdity of the use of regular coordinates for this purpose. Note in the curve, Fig. 3a, how the octaves are crowded at the lower end of the scale and spread out at the upper end. In logarithmic scale,

however, the various octaves of the musical scale are each given equal importance and are actually illustrative of physical fact.

There is yet some doubt as to the proper scale to use in the plotting of amplification in these characteristics. While the semi-logarithmic scale is capable of differentiating between the good and the poor in transformers, it would seem that the double logarithmic paper gives a more accurate picture of what may be expected in the actual performance of the instrument. This opinion is based on Fechner's Law which states that "physiological response is proportional to the energy involved in the phenomena." This means simply that a sound pressure of 1000 dynes, for example, will produce only three times the sensation to the ear as would a sound pressure of 10 dynes, 1000 being the cube or third power of 10. It would not produce 100 times as great a sensation as might be expected. Hence a full logarithmic scale in the plotting of representative characteristics is considered best.

Now, unfortunately, a given transformer does not show the same characteristic under a variety of conditions. Thus, not

only will the characteristic be altered by a change in tubes but also by changes in grid and plate voltages with the same tube. Furthermore, tubes of the same type do not have the same characteristics at the same voltages, so it is important that curves for purposes of comparison bear a notation of the types of tube used, the voltages at which it was used in the test, and the amplification factor and the plate resistance of the tube at those voltages.

This variation of amplification characteristic with change in tube constants is a subject that holds remarkable possibilities for the listener who is striving toward perfection in reproduction.

The characteristic of a given transformer is influenced by the amplification constant of the tube only in the matter of degree. That is, the amplification is high or low in proportion to the amplification factor of the tube provided the plate resistance of the tube is unchanged. This explains the fact that greater volume is obtained from the use of the 201-A type tube, with its amplification factor of 7.5 than from the 199 type with a factor of 6.0. It should not be thought that the use of some of the new

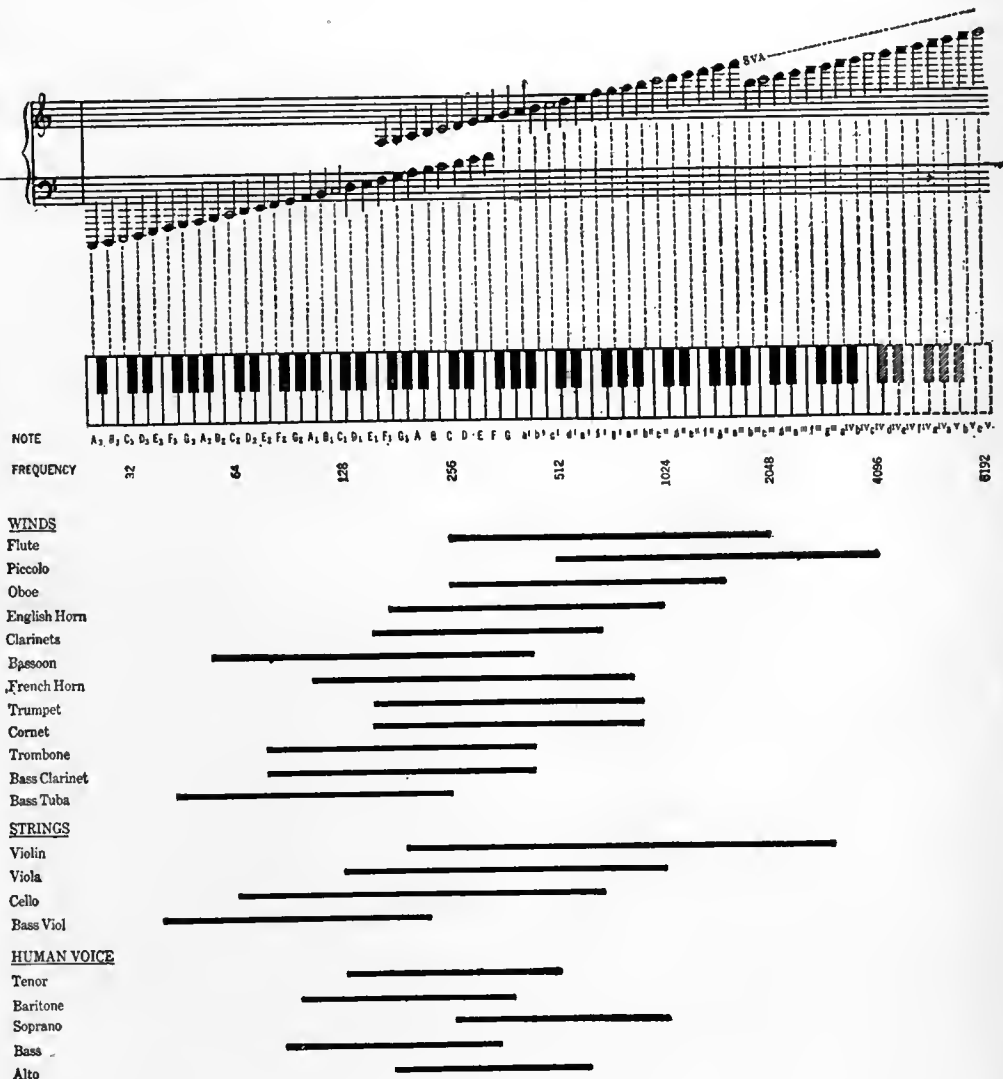

FIG. 2

A most interesting graphical comparison of the frequency range of a piano and other musical instruments. Even though there is overlapping of the ranges covered by these instruments, the particular tone by which a certain type of instrument may be identified is produced by a combining of the overtones emitted with the fundamental tone

high-Mu tubes would be desirable with transformers on this account, however, for there is another consideration in the case.

That consideration is the plate resistance of the tube. It is a difficult if not impossible thing in vacuum tube design to produce a tube having a high amplification constant and a low plate resistance. Hence we find that the high-Mu tubes have an almost correspondingly high plate impedance which produces an exaggeration of the effect illustrated in Fig. 4. Here are shown curves of the transformer previously referred to with a tube having an amplification factor of 7.5 and values of plate resistance of 5,000, 10,000, and 15,000 ohms as marked. This instrument has a remarkably high primary inductance which causes it to produce high amplification at

to increase the bias on the first stage to  $4\frac{1}{2}$  volts, the curve would be modified to that marked 15,000 ohms, for we have increased the plate resistance to that value by the use of a high bias.

It would not be wise to increase the bias beyond  $1\frac{1}{2}$  volts unless required to by the tests described by Mr. Crom, for we would only be impairing the quality at the low frequencies.

On the other hand we might decide, after listening very analytically to our speaker, that the low frequency instruments cannot be heard with quite the volume relative to the other instruments that we would hear them if actually in the studio. In this case, unless the loud speaker has a decided discrimination against the low frequencies there will be some advantage in operating two 201-A tubes in parallel as shown in

Fig. 5. The combined plate impedance of the two tubes would be reduced to 5000 ohms and we would obtain

such proportions that a single 201-A will not handle it without some tube distortion. Therefore, the low plate resistance of two tubes or of a power tube in the last stage will allow the plate circuit to deliver more energy to the loud speaker at the low frequencies.

RESISTANCE-COUPLED AMPLIFICATION

CONSIDERABLE material has been published on the improvement of reproduction at the low frequencies together with various means for attaining it. Among these the claims of the various manufacturers of resistance couplings are predominant. While it is true that the theory of the resistance-coupled amplifier attributes to it the property of uniform amplification at all audible frequencies it can be shown by test that the average resistance-coupled amplifier, as merchandised, does not do very well with the low notes. This is due principally to the low capacity of the coupling condensers advo-

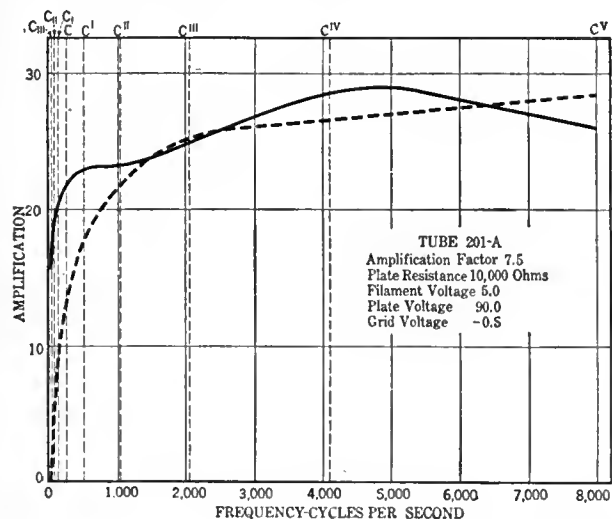

FIG. 3-A

the low frequencies, but note that the amplification falls off at these frequencies as the plate resistance increases, due to lack of balance between the plate resistance and the transformer impedance at those frequencies. This slump of amplification on the low notes would be aggravated with the high amplification tubes and, while the over-all amplification would be very good at the high frequencies the low notes would receive almost no amplification with consequent unnatural reproduction.

Our particular interest in these curves lies, however, in the fact that they represent particular possibilities in regard to selection of tubes. The curve, Fig. 4, marked 10,000 ohms would be indicative of the performance of this transformer when used with a 201-A tube with 90 volts on the plate and a negative grid bias of half a volt. This tube and these voltages would be very satisfactory for operation in the first stage as the grid of the tube would never become sufficiently positive on moderate signals, to introduce the kind of distortion discussed by Mr. Crom in the October RADIO BROADCAST. If we were

Here are three curves, A, B, and C. They are all for the same two transformers. It is evident that by using one kind of cross section paper, the curve can be made to look as though the transformer measured was very good and amplified well over the frequencies desired. From an inspection of the three ways in which a transformer curve may be indicated as presented here, it is obvious that the curves in Fig. 3A are not honest in comparison to those shown in B and C. In Fig. 2 we saw that the tones and sounds we are most interested in ranged from about 32 to 4000 cycles. Yet by presenting a curve as in A, attention is subtly centered upon the flat portion of the curve which deals mostly with the high notes. The amplification at the lower frequencies is negligible compared to the higher frequencies. In B this condition is corrected somewhat by the use of logarithmic cross section paper where the frequency is plotted on a logarithmic or octave scale. However, the amplification indication is not of the same scale. The scale employed in C is favored by many as the true way to represent response curves for audio transformers. Here the frequency increases on the logarithmic or octave scale, as it is played on a musical instrument. Also the amplification in 3C is plotted logarithmically which is probably the way in which the ear hears sounds

FIG. 3

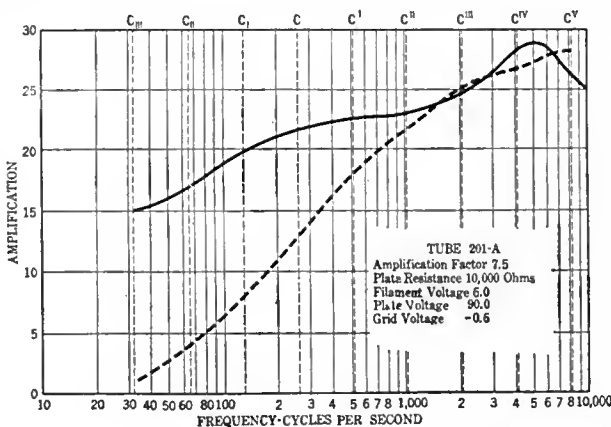

FIG. 3-B

the curve shown for that figure on the chart. Or, we might use a single 216-A tube with some sacrifice in amplification (amplification factor 5.6) but with the same quality. The grid bias in the second stage should not be omitted due to the risk of the grid becoming positive and drawing current as described in Mr. Crom's article. Here, however, the use of semi-power tubes is desirable, for the output signal from the first stage has reached

cated in such amplifiers, whose impedance at 30 to 60 cycles becomes so high as to prevent an effective transfer of voltage to the succeeding tube. The only remedy for this condition is in the use of larger condensers of from one half to one microfarad, and even then there are often certain limitations that make it nearly impossible to obtain the quality of reproduction possible in a well designed transformer-coupled amplifier.

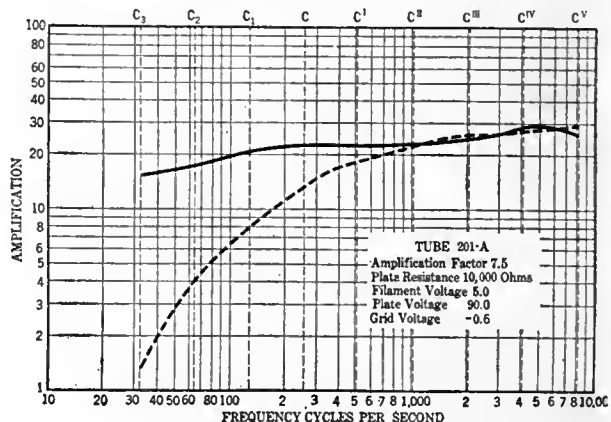

FIG. 3-C

The principle of these limitations is the inability of the resistance amplifier to over-amplify the high frequencies. It has been the writer's experience that the average loud speaker discriminates against the high frequencies in such manner as to make it desirable that the amplifier supply a little more energy at these frequencies than at the low or medium frequencies.

In addition, in the more selective receivers the detector output shows a falling characteristic, that is the low frequencies are louder than the high, due to the tuned circuits of the radio amplifier cutting the sidebands of the transmission. This effect is illustrated roughly in Fig. 6, showing the output characteristic of a regenerative detector. Hence the desirability of being able to amplify the high frequencies to a greater degree than the low tones.

It is not the contention of the writer that all transformers are good in this respect. The majority of the transformers on the market show such ineffectiveness at the low frequencies that it is impossible to offset their characteristics. One particular transformer on the market is very poorly designed as evidenced by the fact that at 125 cycles it ceases amplifying entirely and from there down is actually nullifying the amplification obtained from the tube. From 30 to 60 cycles, an octave in the bass of the piano, it actually attenuates the signal to a greater extent than the tubes' ability to amplify, so that any note in this octave would actually be louder at the detector output than at the output of the amplifier. Unfortunately there are several transformers on the market that have similar characteristics, so the necessity of knowing the characteristics of

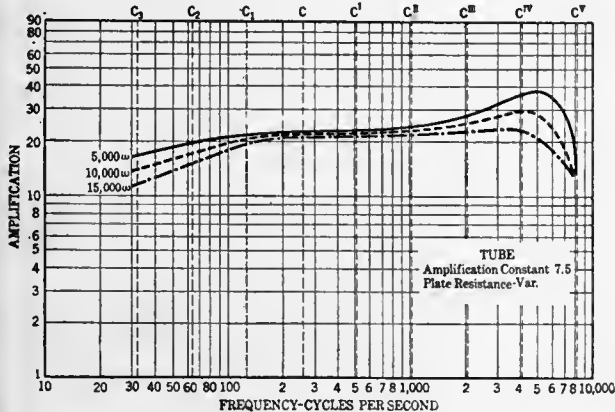

FIG. 4

Simply because a tube is called high- $\mu$  it does not follow that better amplification will result. It is difficult, in high- $\mu$  tubes, to obtain a low plate impedance. As the value of  $\mu$ , shown here, increases, the plate impedance increases. From the curves shown above it will be observed that as the plate impedance is increased the amplification falls off correspondingly. However, when high- $\mu$  tubes are used in a resistance audio amplifier, the story is entirely different

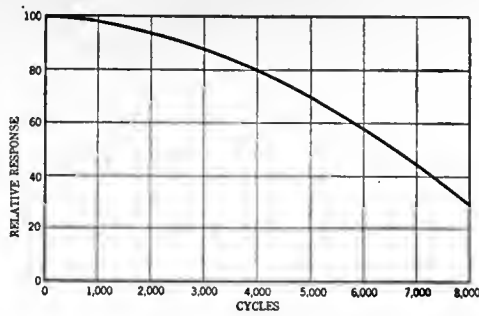

FIG. 6

Briefly, this curve shows that as regeneration is increased the response on the higher frequencies is reduced

a transformer over the entire frequency range of the piano becomes very evident.

There are several transformers on the market suitable for low frequency reproduction and among these is the transformer whose characteristic is shown by the solid line in Fig. 3c. The extremely good amplification obtained at the low frequencies is made possible by the use of a novel core con-

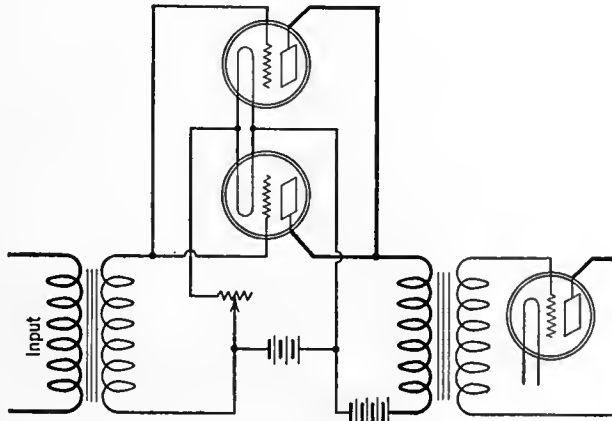

FIG. 5

By paralleling the elements of tubes as shown, the effective plate impedance is reduced to one half the value of one tube. However, this arrangement does not increase the amplification but does increase the power output of the amplifier

struction known among power engineers as the cruciform.

The advantage in this type of construction is the fact that the magnetic flux developed by the windings is almost completely confined to the iron core, with the result that the primary inductance obtainable with a given amount of iron is higher with consequent better transformation at the low frequencies. Fig. 7 shows the manner in which the flux leaks out into the surrounding space with the more usual core construction, while with the cruciform construction the coil is so completely surrounded by iron that the leakage is negligible.

EDITOR'S NOTE

IN THE October, 1925, RADIO BROADCAST, an article by George C. Crom reviewed certain considerations of audio frequency amplification which are quite fundamental. Some of the readers of this article may not have seen Mr. Crom's remarks, and so, reprinted below are several paragraphs dealing with the requirements, as Mr. Crom sees them, for distortionless amplifier operation. These conditions apply to the amplifier tube itself:

*First*—The filament of the tube must be operated at a temperature high enough to supply all the electrons resulting from the sum of the direct plate current and its audio frequency component. The majority of good tubes give this necessary electron emission at low temperatures such as that resulting from 4.5 to 5.5 volts across the filament of a five-volt tube.

*Second*—The plate circuit should have sufficiently high impedance. This high impedance straightens out the curve which is usually referred to as the operating characteristic, and is explained in Paragraph 60 of *Thermionic Vacuum Tubes*, by Van Der Bijl. The discussion there is too involved to be detailed here.

*Third*—The grid must be maintained negative with respect to the filament so that at the positive peaks of the signal-voltage wave, appreciable current does not flow to the grid. If current does flow to the grid, it pulls down the plate

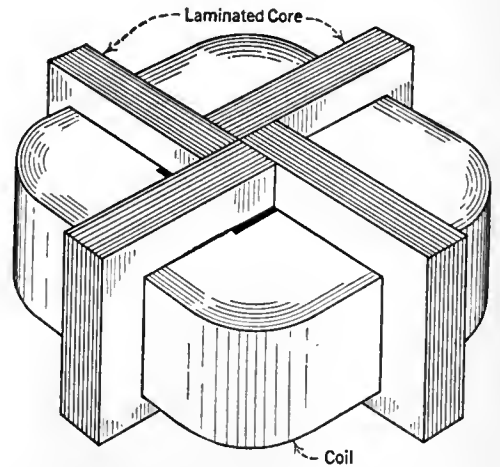
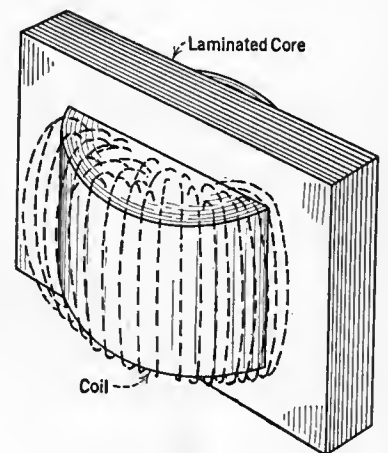

FIG. 7

The lower illustration shows the flux leakage prevalent in most transformers. This condition can be remedied by the intelligent use of iron cores situated as shown in the upper sketch



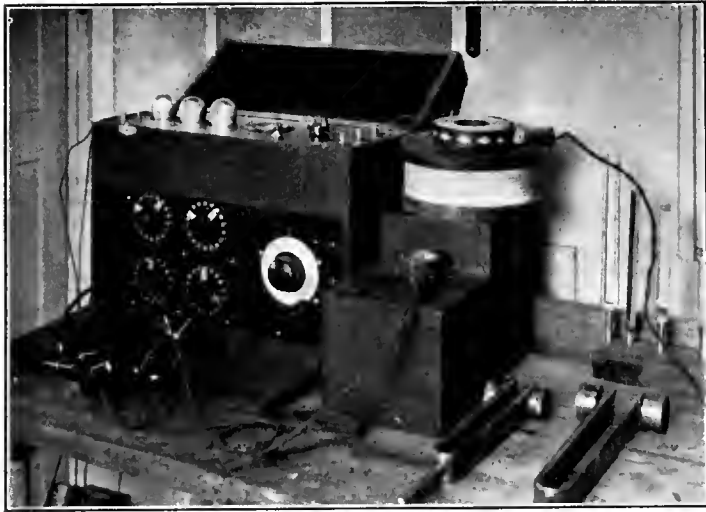

FIG. 9

This is a detailed view of the audio-frequency oscillator. The dial and switches on the front of the panel allow the adjustment of the instrument to frequencies ranging from 30 to 100,000 cycles with three inductance coils. The large white coil at the right is the coil for the medium range frequency. Note the phones attached to the small pick-up coil used for picking up the tone of the oscillator for comparison with the standard fork. The large fork at the left has a pitch of 32 cycles and near it is a fork of 64 cycles

current and causes a bend in the operating characteristic curve, that is, the positive peaks of the plate current waves are cut off. As current flowing to the grid must pass through the transformer secondary with its many turns, it may saturate the transformer core, pull down its amplification, and thus cause distortion in the transformer. The value of the C battery necessarily depends on the structure of the tube used and upon the signal voltage. This is not

necessarily true, for individual tubes vary widely.

*Fourth*—the plate voltage must be high enough so that the plate current can faithfully follow the grid voltage. The plate voltage must force the plate current through the resistance of the apparatus in the plate circuit and still apply enough voltage to the tube, so that on the maximum negative signal voltage on the grid, some plate current will still be flowing. In other words, the negative peaks of the plate current waves must not be cut off.

These conditions sound complicated, but they are not when stated simply. The first is: use good tubes and keep your A battery charged. The second is: use good transformers. The third and fourth are: use the proper value of C battery for the signal voltage at the grid of each tube, and a plate voltage which corresponds to this C voltage.

The most satisfactory method, and also the easiest, for determining these last two conditions is to put a milliammeter (d. c.,

of say, 0-15 milliamperes range) in the plate circuit of the amplifier tube under investigation and observe the plate current while the strongest signal that is to be received is going through the amplifier. If the C battery voltage is not high enough and positive peaks of the plate current are cut off (and current is flowing in the grid circuit), the plate current will decrease with a strong signal. Increasing the C battery will prevent the grid from going too much positive.

If the plate voltage is too low (in the opinion of the writer, it usually is) and the negative peaks of the plate current are being cut off, the current will rise on a strong signal. Increasing the plate voltage will remove this difficulty."

In an early number, we expect to publish an article about audio frequency transformers which should be of deep interest to everyone in the radio field. We shall show many curves of the electrical characteristics of audio transformers, taken in RADIO BROADCAST'S Laboratory. This feature alone should be very interesting because with so many transformers on the market, it is difficult for the untutored buyer to know just what transformers have the characteristics he wants. The article will explain how the transformers are measured. Some needed light will be cast on the disputed effect of the use of shunt condensers and resistances in audio transformer circuits. The effect of the C battery on transformer operation will be carefully covered.

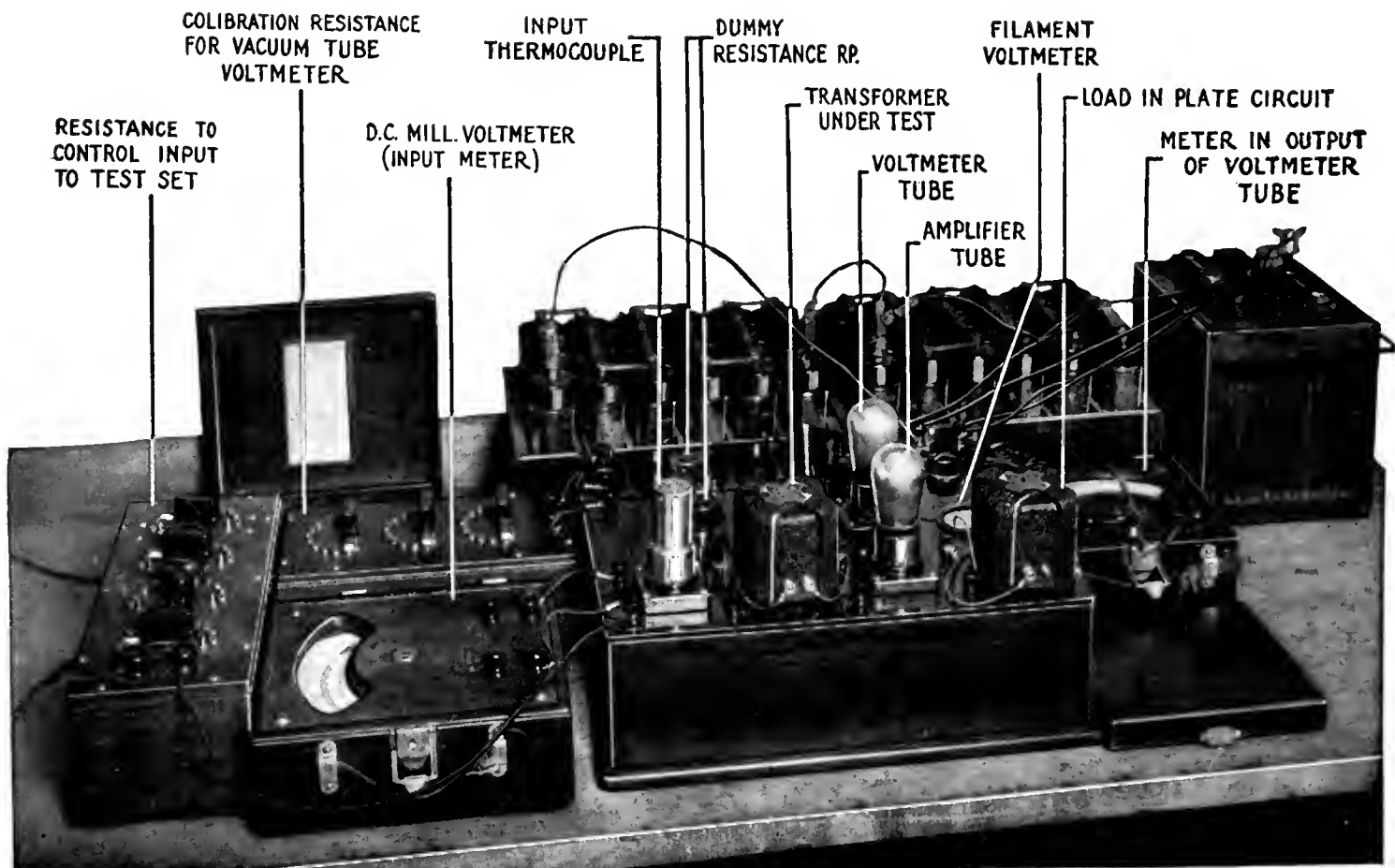

FIG. 8

A close-up which is self-explanatory of the recording apparatus



# Additional Notes on the Model 1926 Receiver

How to Employ Impedance- or Resistance-Coupling in the All-Wave Receiver—How Quality in the Loud Speaker Can Be Bettered by Coupling the Output Tube to the Speaker Through an Auto-Transformer

By ERNEST R. PFAFF

**T**HIS year we find attention concentrated upon the improvement of the reproducing quality of the radio receiver, rather than upon its sensitivity and selectivity as in past years. There is very little reason why this problem should require any very great concentration or experiment upon the part of the enthusiast or listener desirous of building his own, since equipment is available upon the market for audio amplification purposes which will permit of nearly perfect reproduction.

In the November, 1925, RADIO BROADCAST there appeared a description of a receiver developed by McMurdo Silver which possessed ample selectivity and sensitivity, and consequently was admirably fitted for the incorporation of any type of audio frequency amplification desired by the individual builder. In this article, a standard two-stage transformer-coupled audio amplifier was considered, while in the present article, methods of improving this amplifier, the use of resistance and choke coupling, and the application of the new power tubes are considered.

## THE ORIGINAL AUDIO AMPLIFIER

**I**N THE November article, the receiver was shown with a two-stage audio amplifier using Thordarson  $3\frac{1}{2}:1$  audio transformers. These transformers are remarkably satisfactory, though they do not wholly satisfy one condition necessary for distortionless amplification—which is that the primary impedance of the interstage transformer should exceed by three times the output impedance of the tube feeding into it at the lowest frequency to be handled. The primary impedance of the  $3\frac{1}{2}:1$  Thordarson transformer at 50 cycles, which may be considered as the low limit of frequencies to be reproduced is a bit less

than 10,000 ohms, while the lowest frequency at which the condition stated above is satisfied will be in the neighborhood of 175 cycles, since the tube impedance for a UV-201A is approximately 12,000 ohms. Therefore, it is obvious that above 175 cycles, substantially distortionless amplification will be obtained, while below this frequency the gain will fall off rapidly, until some of the lower notes below 50 cycles suffer badly.

The reproduction from practically any audio transformers used in an amplifier can be very appreciably improved by careful and judicious attention to small details, such as by-pass condensers, proper operating voltages for the tubes used, shunt resistances and shunt plate feed arrangements. A most excellent discussion of such features will be found in Mr. Crom's articles in the October, 1925, RADIO BROADCAST.

A point not stressed by Mr. Crom is the use of shunt resistances across audio transformers secondaries, as well as small by-pass condensers across these windings. Grid leaks of from .05 megohms on up to .5 megohms shunted across audio transformer secondaries will invariably help to stabilize an amplifier, and at times will tend to improve its quality of reproduction. Small condensers ranging from .0001 to .0005 mfd., shunted across the secondaries of audio transformers will tend to bypass

some of the higher frequencies, with the net result that in many cases the reproducing qualities of the amplifier for low notes seem materially improved. This, however, is only apparent improvement since it amounts to decreasing the high frequencies to the same volume as the low notes. A combination of resistance and capacity shunt is also frequently helpful.

Where a high plate voltage is used on an audio amplifier, the last stage should not include the loud speaker directly in the plate circuit of the tube. This is because the normal direct plate current would flow through the speaker, to which would be added the alternating signal component. In many cases the handling capacity of loud speakers is decreased to one-half or one-quarter what it would normally be by this arrangement. A much more satisfactory arrangement is to feed the plate supply directly to the plate of the tube through a high inductance choke, such as a Thordarson autoformer, and then shunt the loud speaker in series with a .5- or 1.0-mfd. condenser from plate to filament. In this way, the direct current component is fed through the choke and kept out of the speaker; only the alternating signal component reaching the speaker windings. Thus, the value of signal required to saturate the speaker is that normally required, instead of, with the usual connection, the normal value minus the direct plate current

—often several times the alternating component.

If it is desired to use a shunt feed system in several different stages of a receiver, the choke and condenser can be permanently connected to the speaker and set, and one side of the speaker plugged into the different stages at will. Fig. 1 illustrates a mode of connection which can be applied to any amplifier.

In this case, the join between the

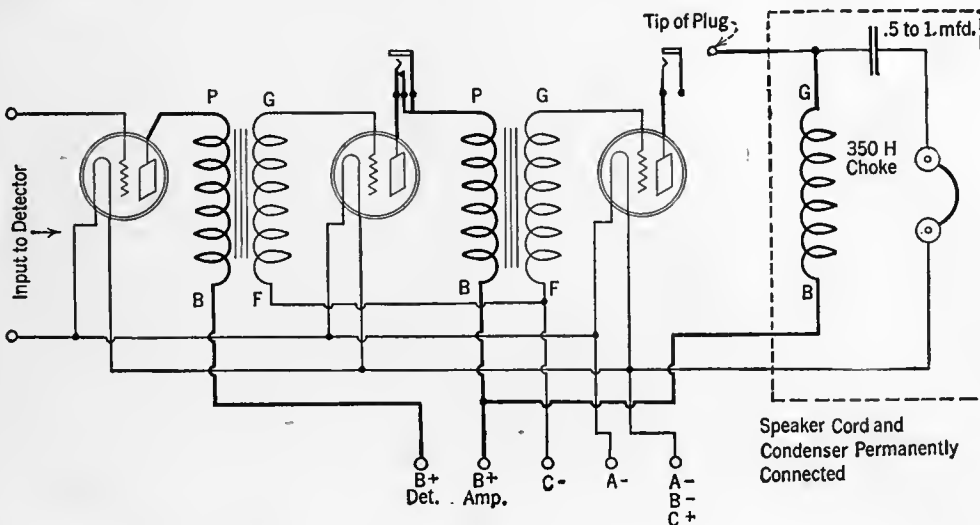

FIG. 1

The circuit of a transformer-coupled audio amplifier showing how the output coil and condenser constitute a separate unit which insures correct functioning of the loud speaker

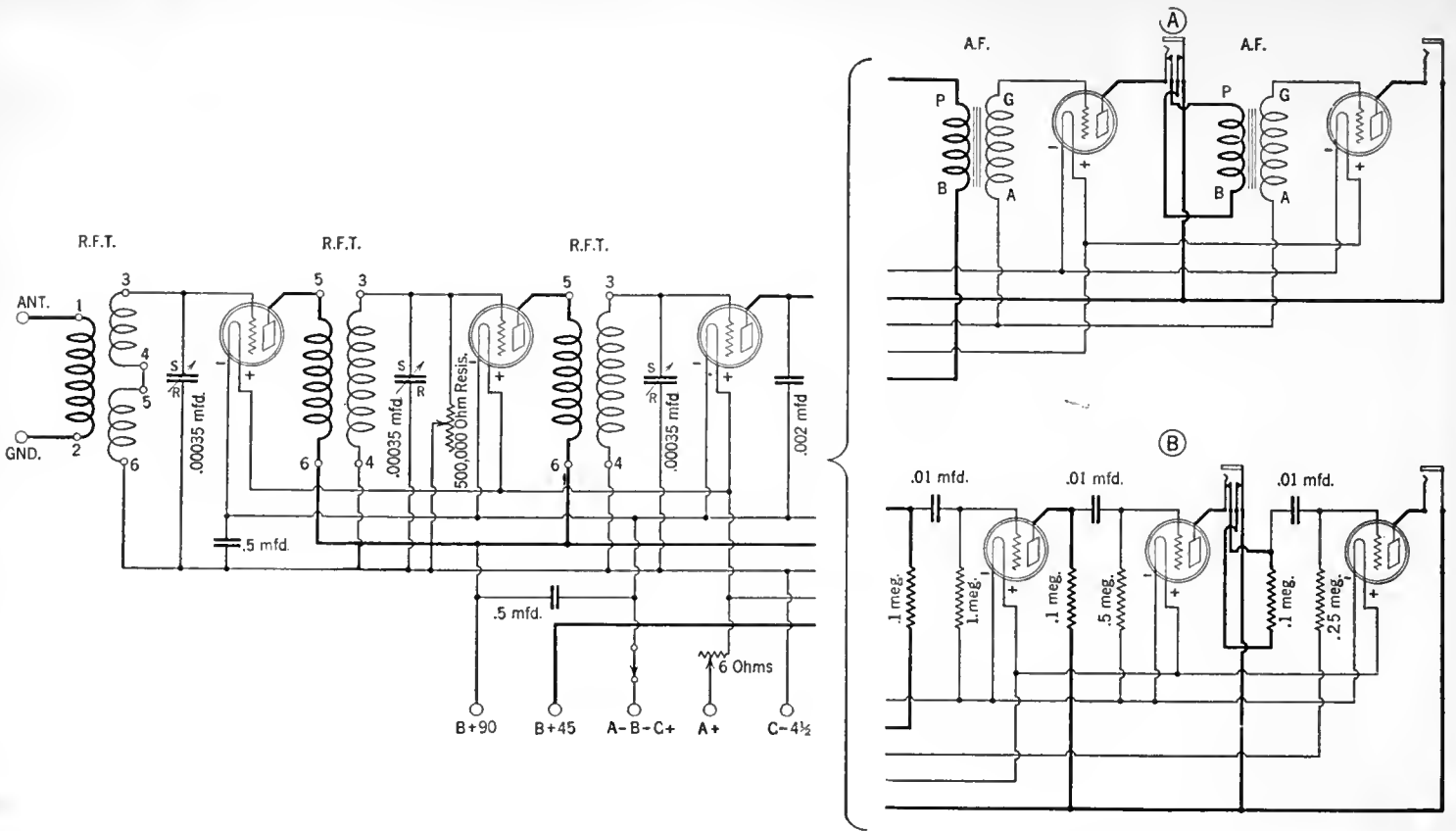

FIG. 2

That part of the circuit to the left is the tuner section of the receiver described by Mr. Silver in November RADIO BROADCAST. To the right is shown two types of audio amplification, the lower is resistance coupling while that above is the regular transformer audio amplification described last month. This circuit shows how one may be substituted for the other

ser connects to the tip of a phone plug only, the sleeve being left free. The arrangement will be found quite helpful.

RESISTANCE COUPLING

WHILE resistance coupling has been popular for quite some time, this is the first season where indications point to a general appreciation of the merits of this system by the listening public. Unquestionably, resistance-coupled audio amplifi-

cation will give as fine quality of reproduction as it is possible to obtain, and contrary to general opinion, it is not extremely wasteful, either from the power consumption standpoint, or the quantity of apparatus necessary to render this system the equal of a good transformer amplifier so far as voltage gain per system goes.

A three-stage resistance-coupled amplifier made up of standard parts, operated on

135 volts, using proper tubes, will give about the same amplification that may be obtained with two transformer stages operated on 90 volts. The actual B battery consumption figured over a period of time is no greater than that of the transformer amplifier, though it is true that the initial battery cost is higher by 50 per cent.

Mr. Silver's six-tube receiver with a resistance amplifier is at its best, for the quality of reproduction is truly splendid.

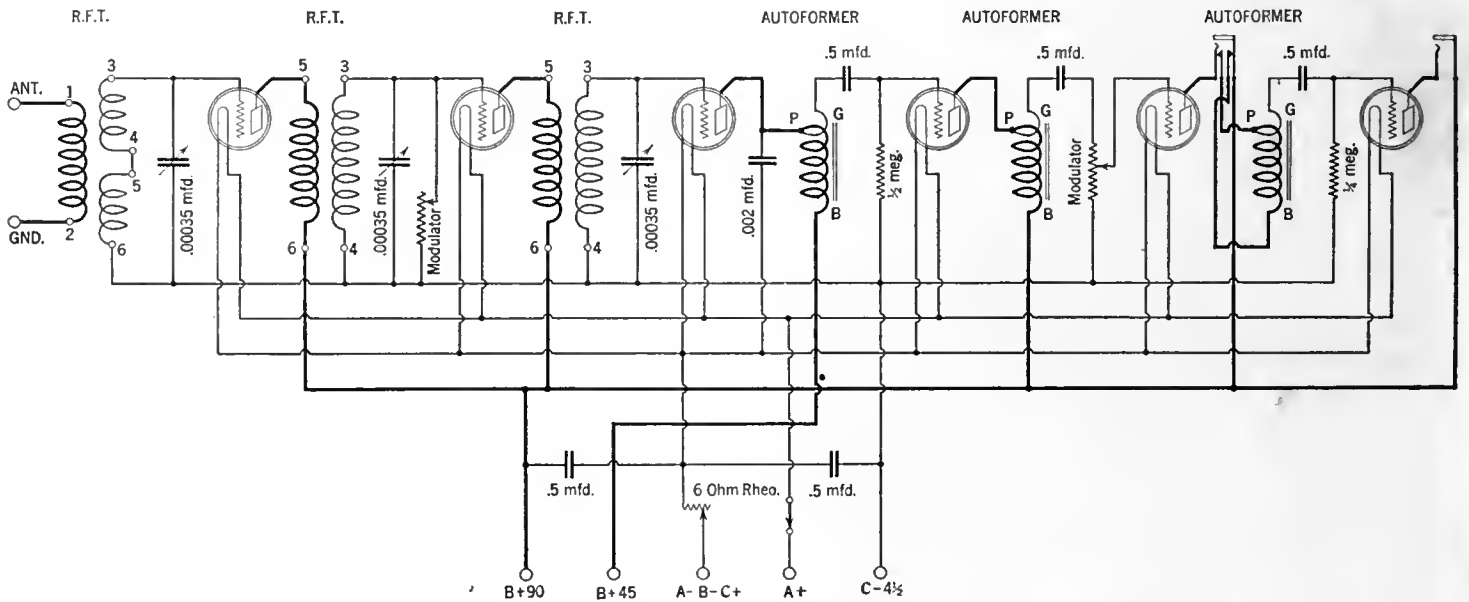

FIG. 3

A complete circuit diagram of the receiver employing impedance-coupled audio amplification. The various features described in the text, such as modulation control on the r. f. secondary and impedance amplifier coil, are brought out here prominently

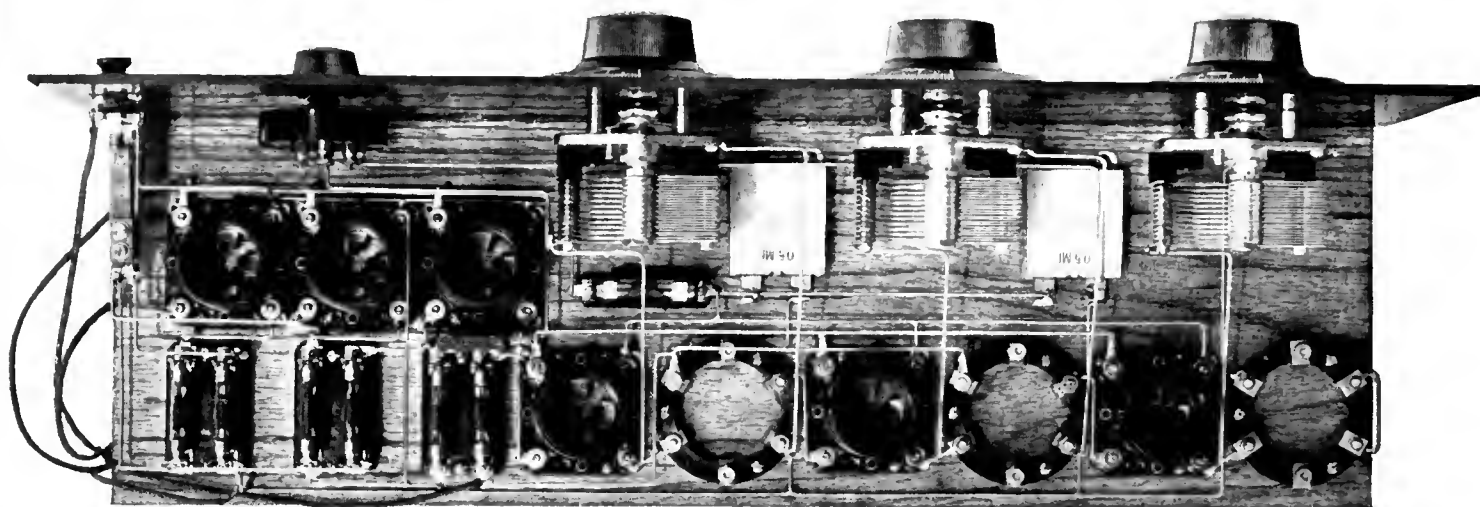

FIG. 4

A view of a model showing the disposition of the resistance coupling units. In all three types, the audio amplifier occupies the same location

and the ease of tuning is surprising considering the extreme sensitivity and selectivity of the set. However, in incorporating this type of audio amplifier, there are a few cautions to be observed.

The detector of the set operates with a negative grid potential of  $4\frac{1}{2}$  volts, which is substantially correct in order to obtain satisfactory rectification using a plate potential of 45 volts. This assumes that in series with the B battery is a transformer primary winding of only one to two thousand ohms resistance—so low as to have hardly any effect upon the actual plate potential. However, with resistance coupling, a resistance of about 100,000 ohms will be in this plate circuit. If the detector plate voltage is increased to 90, rectification will still occur in an efficient manner with a  $4\frac{1}{2}$ -volt negative grid potential. Since the resistance amplifier requires 135 volts, two B battery positive leads will come out of the set—one 90 volts

plus, for the r.f. amplifiers and detector, and one, 135 volts plus for the three a. f. amplifiers. Due to the low actual operating potential of the first two resistance amplifiers because of the high resistances in their plate circuits, no C battery will be required for these two tubes, their grid leaks terminating directly in the negative filament line. The last audio stage has only the loud speaker resistance in its plate circuit—a matter of several thousand ohms, and so should have its grid biased for 135 volts. With a UV-201A this bias would be about 9 volts, although  $4\frac{1}{2}$  will be satisfactory as a basis for test observation.

Coupling units are available made by Muter, Daven, Brach, Dubilier, Polymet, and others, which provide clip mountings for grid leak, plate resistor and coupling condenser—thus but one unit is required to a stage. With UV-201A tubes, the coupling resistances should be 100,000 ohms, the first

grid leak one megohm, the second one half and last one quarter. In no case should the coupling condensers be below .01 mfd., or distortion will be evident, and all the advantages of the system will be lost. Going to the opposite extreme will provide better quality, up to the point where the time constant—the discharge period of the condenser and resistance combination—becomes so low as to interfere with reproduction and cause blocking of the amplifier—.5 mfd. is a satisfactory maximum capacity, though for convenience and general practicability, the writer prefers .01 mfd. at least.

A circuit and layout drawing showing the substitution of three resistance-coupled stages for the transformer-coupled audio amplifiers accompanies this article. See Fig. 2. It might be well to mention the matter of sockets. Those are combination UX or UV sockets—that is, either a UV-201A or a UX-201A tube may be used in them, or for

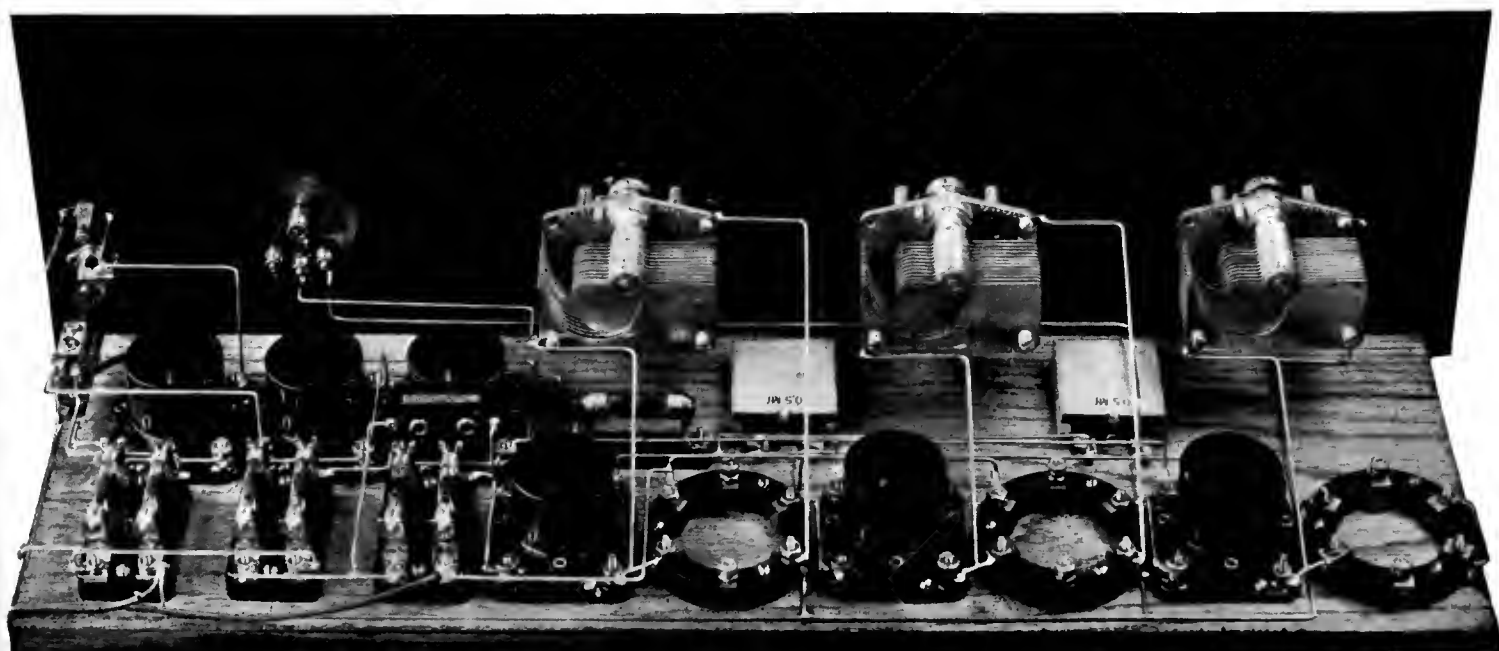

FIG. 5

Another view of the resistance-coupled receiver. The wiring of such a set is very easy as can be attested by close observation of the above

that matter, any other type of UX tube. With the UV bases, the tube pins are inserted in holes in the socket, with the bayonet pin over a corresponding mark on the socket. With other makes of UX sockets, UV-201A tubes may not be used—that is, UX or UV tubes may not be interchanged at will, except in a few cases. Therefore, the builder, if he uses UX sockets, should be sure that his tubes are UX bases.

#### IMPEDANCE AMPLIFICATION

**D**URING the war, "choke" or impedance amplification was quite popular, and was used in various airplane, ground and ship low powered telephone transmitter stations where quality of reproduction was important. The first practical chokes available are the Thordarson autoformers, which are inductances of 350 henrys, tapped so that there is a voltage step-up of  $1:1\frac{1}{2}$ . These chokes satisfy the impedance requirements of a distortionless amplifier very nicely, and will give greater amplification per stage than a resistance-coupled amplifier but not quite as much as a transformer amplifier. They require but 90 volts for their operation, in this respect being similar to transformers.

A three-stage choke amplifier added to a receiver described by Mr. Silver in the November issue is shown in the circuit diagram, Fig. 3. While .5- mfd. coupling condensers are shown, those of .01- mfd. will probably be more practical, due to the tendency of the amplifier to block with higher capacities, for reasons previously given. One interesting feature of this amplifier is the use of the modulator to control its volume. Instead of the conventional shunt resistance which is not entirely satisfactory for audio volume control, the modulator consists of a 500,000-ohm resistance across the output circuit of the second stage. The grid of the tube into which this circuit normally feeds is then tapped in at any desired point on the resistance, thus giving a smooth even volume control from zero to the maximum available. The modulator may be used on an amplifier, of any type, and is to be recommended as a volume control instead of the conventional jack arrangement. It also serves, in this instance, as a grid leak.

#### POWER TUBES

**T**HE use of UX-112 tubes in both stages of a transformer amplifier will improve quality considerably, since, in the case of the Thordarson  $3\frac{1}{2}:1$  transformers, at 50 cycles, the tube impedance is about one-third that of the transformer primary.

However, it is doubtful if any increase in volume will result from the use of UX-112 tubes instead of UV-201A's. Other than improved quality, increased handling power will be obtained. This means that with a very strong signal, the UX-112 will function only without distortion, whereas a UV-201A would probably overload and distort. This is true, provided the proper C battery voltage is used.

UX-112 tubes should really be used with 135 volts plate potential, and about 9 volts negative grid bias. They will function moderately well at 90 volts plate potential with the conventional bias, however.

For resistance amplification, Daven and Cleartron make high-Mu tubes which are ideal for interstage use, and both make a power tube which is excellent for use in the last audio stage. The use of these tubes cannot be too highly recommended, as they will do much to bring resistance amplification into its own, for the improved volume resulting from the use of two high-Mu and one output tube is surprising when compared with the output of three standard tubes.

If Daven tubes are used, no rheostat will be required for them. Thus, the rheostat or ballast resistor if used would be connected in the filament circuits of the first three tubes, while the last three, being Daven tubes designed for 6 volts, would connect directly across the battery.

UX-199 tubes may be used throughout the set if it is intended to operate it on dry cells. If this is done, the UX-120 should be used for the output stage, or entirely in the audio amplifier if transformer coupling is used.

#### OPERATION

**I**T APPEARS that in preliminary operation, builders have experienced some difficulty in getting distance until they were familiar with this receiver's operating peculiarities. It might therefore be well to go over the mode of operation again.

Assuming locals to be received properly, the antenna coupling coil should gradually be turned out until the desired degree of selectivity on the first, or left, dial is obtained. This setting will react on the volume control, and may be found by tuning-in a high frequency (short wave) station, setting the volume control so that the arrow points straight to the right, and gradually loosening the antenna coupling until the set breaks into oscillation. This is a proper operating position for the antenna rotor, where it may be left permanently set. If the volume control is then turned counter-clockwise, the set will stop oscillating and it may be tuned as one would a

neurodyne—that is, all three dials will be set about alike for a given station.

If maximum sensitivity is desired, the volume knob should be turned clockwise until, with all three dials set in resonance, i. e., in a position where a station would come in, the set breaks into oscillation. Then, if one dial is moved, it will click out of oscillation, but if both dials are moved after the first a corresponding amount, oscillation will start again.

In this fashion the three dials may be moved up the entire scale in hunting for a station in steps of one or two degrees at a time. Using this method, a station will come in as a squeal. To tune-in properly, the first and third dials should be set right on the squeal—that is, so moving either one in either direction will cause the pitch to increase. Then, with the middle dial set dead on the squeal, the volume knob should be retarded until the squeal stops and the signal is audible.

No squeals will be heard if tubes or batteries are not good, or if too long an antenna is used. In some cases it may be necessary to add two or three turns to windings 5-6 of the radio frequency transformers. They were described in the November, 1925, RADIO BROADCAST.

In case too short an antenna is used, it may have to be connected to point 4-5 of the antenna coil socket, with the ground to the minus filament line. If one stage of r. f. amplification is to be cut out, the antenna connects to No. 5 of the middle socket, with the ground to the filament, and the antenna coil removed.

To use a loop, the antenna coil is removed and the loop connected to points 3 and 6 of the coil socket.

#### SINGLE OR DUAL CONTROL

**S**INGLE control will not be found entirely satisfactory in this receiver, but dual control will work quite nicely. This is because of the extreme selectivity of the outfit, which renders each circuit so sharp that minor variations which cannot be overcome cause trouble. The second and third controls may be connected so that they will work together if only one knob is turned by tying a piece of heavy braided fishline around the pulleys on the two condenser shafts. The ends of the line should meet in a light coil spring which can be gotten from a hardware store, and which serves to take up any play. It also allows either dial to be turned independently by loosening up whenever pressure is applied to either dial separately. With this arrangement, only the first and second dials need be manipulated for tuning, and operating the set becomes a real pleasure.

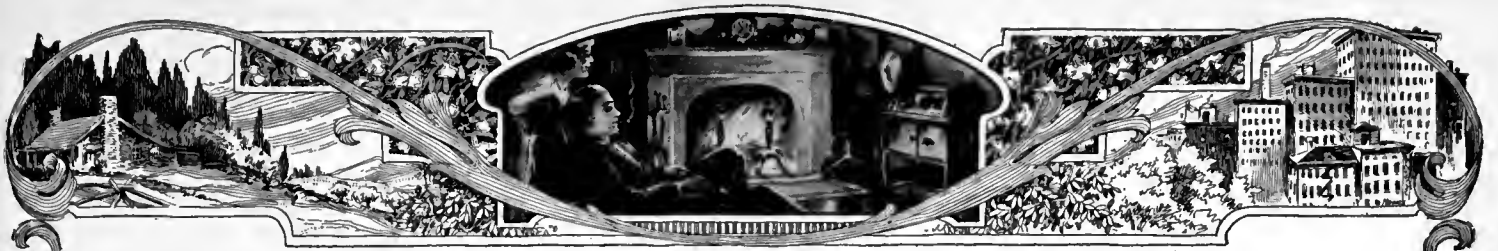

# The Listeners' Point of View

Conducted by ..... John Wallace

## The Design of Receiving Sets

**T**HE one phase of the radio industry which, as far as we have observed, has received no adulation in the public prints, and which, we are convinced, is the one and only phase of the whole phenomenon that is worthy of unstinted praise is the astounding excellence of design of receiving sets.

Almost every new invention has spent its infant years decked in the most ugly of habiliments. It has been the good fortune of radio to be swaddled from the start in a manner to make Velasquez' *Infantas* look dowdy.

The early talking machines were ungainly looking eye-sores, with great over-size cranks, and hideously decorated and uncouthly proportioned horns.

The first automobiles were a laugh. They strove valiantly to keep up the appearance of their horse drawn predecessors, and succeeded only in being a silly travesty on the same.

The history of automobile design in America, if we may digress, has been an interesting one, and a supreme testimonial to the Great American God, Standardization. After its shamming days were over and the automobile had decided to "be itself," there was a constant and rapid improvement in its appearance. This improvement continued until a very few years ago, when disaster suddenly overtook it.

In their endless struggle to go their competitors one better, the manufacturers called in Professional Designers to supervise their coach work. Now, designers worthy of the name simply do not exist in America. The fact that the United States was the only great nation of the world that found herself unable to participate in the Industrial

Arts exhibit lately held in Paris, would seem to support this contention.

What the Professional Designer did to the automobile body can be only too quickly perceived by a casual glance toward the nearest boulevard. Past us they ooze—a flock of elegant black seals—as diversified in appearance as the well known peas in the pod—sleek and elegant, but with no vestige of individuality.

The error into which they have fallen is one of over-refinement. All accessories are concealed in one svelt ensemble. Refinement is desirable but, gosh, not so much of it! Structural lines may be emphasized or subordinated, but they cannot be annihilated if the result is to be design in good taste. The Packard's design seems to have been the goal of the imitators. Cadillac held out nobly, but it, in its last edition, succumbed and now is as characterless as

the rest of them. The old game of "What make of car is that?" has ceased to be a game and reduces itself into a guessing contest. Certainly the automobile was more fortunate when its body was designed by one of the plant engineers in his off hours.

In fact probably the best, and certainly the most American, design in this land at the present day is the work of the engineer. The engineer goes directly and efficiently to his goal, makes his designs to suit his purposes, and having attained them, adds no superfluous and meaningless adornments, nor attempts to cover up what he has done with sham work. So his products are inevitably beautiful—beautiful in their simplicity and in their adaptation to their purpose.

Certain radical French artists, notably the late, unlamented Dadaists, have been so obsessed by the beauty of mechanics that they have smeared vast quantities of canvas with their interpretations of turbines, and girders, and egg beaters, and what nots. A pretty tribute indeed; if hardly a justifiable procedure in a supposedly creative art.

It is improbable that the radio engineer when he set about devising a container for his half bushel of parts, had in mind the making of a definite and important contribution to industrial art. He simply went ahead and made the most practical and efficient case he knew how.

But, whatever his intentions were, he succeeded in creating a "thing of beauty." We know of few merchandise displays out of which we get a more definite and legitimate aesthetic kick than a window full of first class radio receiving sets.



DR. S. PARKES CADMAN

Pastor of the Central Congregational Church, Brooklyn, New York. Doctor Cadman's afternoon talks before the Bedford Branch Y. M. C. A. Brooklyn, every Sunday at 3:45 P. M., are broadcast by WEAJ, WEEL, WTAG, WCAE, and WSAI. In addition to his very large following, gained by the sheer force of his preaching in his own church, his broadcasting activities in the past few years have made him one of the most popular preachers ever to appear before the microphone

All are housed in simple wooden cabinets of pleasing proportion. And their panels are enough to make any one with any sensitivity to design whoop with joy. The regular arrangement of gleaming dials, with here and there smaller circles artlessly placed, is an application of one of the fundamental principles of good design—the repetition with variation of geometric forms.

Now please don't reduce this eulogy to absurdity by suggesting that if that's the way we feel about it, we forthwith white-wash our Rembrandt and cover its gilt framed canvas with assorted radio dials neatly glued on. It's the fact that the dials have a *raison d'être* on the radio panel that makes them beautiful. The same set of dials applied to the front door would be meaningless and ugly.

Some of the cone type loud speakers are as pleasing in form as a Greek vase (as to the goose neck horns, we'll never admit them to be other than unsightly). And an outside loop never ceases to delight us with its concentric, diamond-shaped wiring.

The innards of our set we likewise find intriguing (though we confess here and now we don't quite know what they are all about). Anyway we like the way those wires run around in neat little parallel lines, dodging tubes, and coils, and miscellaneous gadgets.

More power to the engineer! Would that his kind made up the membership of our lamentable "Civic Art Commissions."

But, alas and alack! even as we write, the so-called Designer is getting in his dirty work in the field of radio, and we are more and more frequently being pasted in the eye by receiving sets masquerading as Chinese pagodas, lamps, canary cages, electric heaters, fish bowls, and Louis XVI medicine chests.

### What Sort of Fellow Should the Announcer Be?

SEATED in the theater awaiting the rise of the curtain on what was declared by all the critics to be the best show in town, we were presently brought to our feet by the arrival of a portly gentleman accompanied by his multitudinous family. We hitched in a reluctant patella and they squeezed through to their seats. Following them, the usher's hand, laden with programs, brushed by our nose. These were distributed to everybody down to little Willie, and all immediately buried their noses in them. At once a buzz of indignation began.

"I don't think much of the picture on the cover," growled Pa.

"There aren't any beauty hints or fire rules," whined Gerty.

"Shucks, where are the jokes?" wailed Willie.

"The program is rotten," said Pa with finality, "Let us depart!"

We hitched in a willing patella and they filed out, doubtless to seek some theater

which presented a program of more attractive format and content.

\* \* \* \*

But what we started out to say before we got side-tracked on the above fable was: Why the importance attached to radio announcers? Why are their photographs continually staring us in the face in the public prints? Why have their names become household words?

Announcers are—or should be—simply substitutes for the printed program. How they part their hair or what they thought of the last selection is of no concern to us. We will not lament with little Willie if they offer no jokes.

The announcer *par excellence*, in our opinion, is the one who is only slightly more human than an automaton; who conveys the desired information in the minimum of words and intrudes no more of his personality than would a column of 8-point Caslon.

And, while we're on the subject, do they say "This is *radio station xyz*" to keep us from falling into the error of suspecting it to be Post Hole Factory *xyz*, Cumulus Cloud *xyz*, or Choir of Angels *xyz*?

### From Ten P. M. to Two A. M.

IF EVER the disciples of Mercury crave substantiation of their suspicion that this is a nation eighty per cent. moron, they have only to plug in on the air any time between 10 P. M. and 2 A. M. Shades of Euterpes! What manner of cacophony greets the ear? You, little boy in the back row? Correct!

Now this department hereby declares it has no quarrel with jazz as such. But what does make it stand up on its hind feet and yowl desolately is the insufferable punkness of present jazz.

Popular music always was and always will be, and we contemplate no diatribe against it. In fact, to give it due credit, it should be remembered that the serious music of the present owes considerably more to the popular music of the past times than, say, to the classic polyphony of the church.

But the rhythmic caterwauling that is spewed forth by a hundred-odd (very) dance orchestras every night can only by courtesy be called popular music. "Popular" no doubt; but "music" . . . no!

If memory serves us right, we used to have a rather respectable brand of dance music in this country five or ten years ago. The tango brought with it no end of delightful pieces of melodic interest and colorful Spanish trimming. But melody and color have been consigned to the puppies. The only goal of present terpsichorean thrumming seems to be the maintenance of a rhythm. And this a hundred banjos do every night, with dogged and monotonous persistence. The result may be satisfactory for dancing but is far from delectable to the listener-in who is not, at

the moment, imitating a kernel of corn in a popper.

Imagine, if you can, the music lover of a couple hundred years hence, collecting the "quaint old fox trot melodies of the twentieth century" as we do the charming old gigue, sarabandes, minuets, and polkas.

The trouble with modern jazz is not that it is jazz, but that it is poor jazz. Our high-hat friend who comes out flat-footed with the statement that he cannot bear popular music in any shape or form can, nine times out of ten, be labeled a four-flusher. Of course there is that rare tenth person who really understands music, and, understanding it, realizes that popular music is a very hollow echo of the real thing. But even an epicure occasionally enjoys a fried egg.

The line of demarcation between popular and serious music is not as exactly defined as some would have us suspect. At last reports the savants had not yet voted a unanimous ballot as to which rank claims M. Igor Stravinski. But, even as jazz can approach perilously near to being music, so it can likewise move a long way from it. Jazz, as is, has retreated to the limit. The tom-tomery of the aboriginal head hunter must have been less obnoxious than that which delights the present day sheik, if for no other reason than that the savage had fewer instruments—and no saxophones—with which to perpetrate it.

Popular music has been defined as differing from the serious by a diminution of the intellectual content. If the entire intellectual content of the selections that pollute the air from 10 P. M. to 2 A. M. were stood on end it would about equal the intellectual content of the third act of *Abie's Irish Rose*—or, if you must have your statistics stated graphically, it would be slightly higher than the grasshopper's instep.

In the aforementioned epic of the American stage, not an event transpires which can not be anticipated twenty minutes in advance by any normal fourth-grader. So in our modern dance music, the unexpected never happens. One piece is the Siamese sister of the other. The tunes are the same; the orchestration is the same; the banality is the same. You, gentle reader, could sit down at the piano now and write something better, and—so could the jazz composers!

But if the dance music that clutters up the long suffering ether from 10 P. M. to 2 A. M. is about as entertaining as a game of three handed bridge played with isinglass cards, what can be said of the songs that adorn those sad four hours? They are all cut from a pattern: either riotously "peppy" or lugubriously sad. Of the two, we most abhor the latter. "I want some bah-ha-dy. . . ." we hear a sacharine barytone imploring from *xyz* at a speed of  $2\frac{1}{2}$  miles per hour. And from *zxy*, a tearful and flat soprano wails: "Like a rose-uh, I'm all, alone-uh!" And



QUIN A. RYAN

Director of WGN, Chicago. He reported the Big Ten football games. Mr. Ryan's sports reporting is exceptionally graphic and manifests a very complete and thorough preparation of material. He also reported the Kentucky Derby, Indianapolis Auto Races, and World Series. Inclined to rhapsodize poetically—but the stuff *is* poetical!

we are all but overcome by a wild urge to call up their respective stations and arrange for a get-together. Continuing with our statistics: if all the sickly, sentimental ballads broadcast of an evening were placed end to end they would reach from Athol, Mass., to the Pacific Ocean. That statistical end attained, we would place ourself at the eastern end of said column and push.

"But," it is protested, "that is what the pee-pul want, and what the pee-pul want they should have!"

With both these propositions we take exception. In the first place, we are not convinced that such a large number of individuals as is imagined want this juvenile sort of musical substitute. There exist a goodly number of persons who are satisfied with this tasteless diet because they have known no other, but who, nevertheless, are capable of gustating something at least a little more meaty.

Take some ignorant looking yokel in the lowest ranks of the army of listeners - in. Suppose it is discovered that he has assembled his

own receiving set. Then, say we, if he has brains enough to know what is inside that mysterious box that brings him in his radio entertainment, he, by that sign, has brains enough to appreciate to some extent the content of music. IF he gets a chance. If, for instance, we were to ask him: "The song of what small bird, frequently found in clocks, furnishes the motif of *Japanese Sandman*, *Carolina in the Morning* and Berlin's *Pack Up Your Sins*?" we will wager he could discover the answer, and in so doing he would have, after a fashion, discovered some of their "content." But it is to the second proposition—"what the pee-pul want they should have"—we take the most violent exception. Let them, say we, go without it!

A cursory glance at this mortal coil discloses it to be populated by two principal classes of beings: the common pee-pul, and those existing to serve the common pee-pul.

"Pity the poor masses!" we hear constantly reiterated. Pity, rather, the poor "classes," we shout. They are the ones who are getting the rotten deal in this age of the proletariat.

Everywhere the low-brow turns, he finds someone waiting to serve and entertain him, to supply at a moments' notice his slightest want. While the poor high-brow searches about taking his scant pleasures where he may. What's more, the high-brow's entertainment comes high (unless it be communion with books) and more



GRAHAM MACNAMEE

of WEAF, who, with Phillips Carlin, reported several important games played in the East. Among them were the Chicago-Pennsylvania, Yale-Army, and Cornell-Penn games. The cup Mr. MacNamee is gazing at is a popularity trophy awarded him some moons ago. Inclined to improvise comically—but the stuff *is* comical

often than not he has less money than his slanty-domed, ditch-excavating neighbor.

With half the world catering to the masses' whims, we often wonder why existence does not become a surfeit and a bore to said masses. If *Fuzzy Wuzzy Baby* played on a tomato can is the *summum bonum* in music to them, imagine how constantly they are surrounded by art!

Imagine a world in which every open cafe door emitted strains of Brahms and DeBussy, and passers-by whistled airs by Palestrina (are they whistle-able?). A world in which every billboard bristled with El Grecos and Titiens, and every vaudeville skit displayed the artistry of a Strindberg or a Synge!

Well now that we've quite completely disposed of the issue—whether the public should get what it supposedly wants, let's get back to the subject, which, if we remember, was jazz.

A little jazz is relished by the best of men (now and then) but there's no relish in the variety on the present market. Even the redoubtable Paul Whiteman is dishing out the same monotonous



THE RADIO PLAYERS AT KGO

A presentation of William Archer's "The Green Goddess" before the microphone of KGO, at Oakland. This is the way the radio villain loses his life—under protest (his own)

stuff as the rest of them, the while riding on a reputation created by mob hysteria and which he has long ceased to deserve.

In conclusion: give us jazz, Oh Mister Popular Music Composer! We can stand our share of punishment. But, frevvens sakes, give us a better brand of it. We will trade seventeen *Yes, Sir, That's My Baby's* for one *Allab's Holiday* . . . or what have you?

### Broadcasting Funeral Services

AS ONE of the outstanding examples of bad taste in broadcasting that has come to our attention during the past month, we submit the broadcasting by a Mid-Western station of funeral services for one of its departed minstrels.

Certainly the man was a most excellent entertainer and his death was regretted by those who had come to know him through the air. But we question whether their grief was so sincere as to justify their being, not merely invited, but forced, to attend his obsequies. And of course thousands of listeners-in had never even heard of him before. It is a doubtful mark of respect to the deceased to intrude his funeral eulogy into what may be a dancing party, a convivial dinner, or a poker session.

Assuming that the whole nation was

genuinely "bowed in grief" over the death of some great statesman or outstanding leader, a radio funeral service might be not only appropriate but almost imperative. In the instance cited the service was given an importance out of all proportion to the importance of the deceased.

### Broadcast Miscellany

DOUBTLESS ere this appears in print the results of KOA's aerial battle, "Jazz vs. Classical Music" will have been published. And the statistical lore of radio will have been enriched by an impressive array of figures tabulating the judgment of the populace as to which was the winner.

But as to the possibility of this musical debate having lured the army of jazz lovers over to the enemy camp, or vice-versa, we are inclined to believe that the prophetic utterances here appended will have been realized:

—AND MAKES NIGHT HIDEOUS—

Jazz and classical music are to fight it out in the air. KOA will stage the battle in Denver on November 6. The ringside is the continent—or where you will. Seats are free. The betting is heavy on both sides.

The ethereal, soul-stirring sonata will spar with the sole-tickling slide of the trombone. The thunder of the Mountain King's Ball will roar defiance at the comic saxophone simulating a psychic jackass extemporizing during the vernal equinox. The graceful minuet pirouetting on the gossamer of imagination must hurl the lance at the primitive pom pom moving to fleshly ecstasy the "fat black bucks in a wine-barrel room." The flute, capturing bird notes still fresh with the dew of morning, must fence with the piccolo harmonizing feline infelicities at 2 A. M. Faust, meditating divinely on Margarita's dwelling, must come to vocal blows with a "gent" in rainbow linen and checkerboard socks snapping out "Yes, Sir, That's My Baby."

Beethoven, Bach, Handel, Gounod and all the other masters who are doing their harmonizing among the celestials will descend as an awful nightmare upon the living hip-wigglers and will utterly demolish Polasek's "Spirit of Music." The boys in the pool-room will say "That was some jazz." The girls in the School of Music will buy tickets for the Spring Festival. That's how the world of music will be changed.

News—Index  
Evanston (Illinois)

LET the calamity howlers take note: radio has added several things to the credit side of its somewhat unbalanced ledger since last writing.

First and foremost on its list of achievements we place the broadcasting of the autumn's football games. Here is radio at its best—performing a unique service that no other existing agency can do. Music we can get, after a fashion, on records; speeches can well wait perusal in the morning paper; but a football game to be properly enjoyed has to be lived through. Certainly the broadcasters made us feel as though we were right down on the sideline bench with the water boys and the coach's relations.

A close second on the list is the epochal undertaking of WFAF—the weekly broadcasting of first rate artists. And *paid* artists at that! Not pluggers for Whoozis Garters or Whatzis Shaving Cream.

Mr. A. Atwater Kent is the sponsor of this concert series, which has been broadcast by WFAF, and connected stations, Sunday nights since October 4. The list of singers and musicians who have already been heard and those yet to come reads like a roster of Who's Who in Musical America.

Other isolated instances of genuine musicians performing via radio could be mentioned. Station KGO's Tito Schipa concert, and KFI's program by Mme. Schumann-Heink come to mind.

And all these events presage a brighter future for radio programs. A small beginning, perhaps. An hour of music is a small drop in the bucket of several hundred hours of mediocrity. But vastly important because it is a beginning.



FORD AND GLENN

Ford Rush and Glenn Howell; which is which we don't know. As entertaining a pair of comedians as have ever been heard by radio. They were recently broadcast by WFAA, Dallas, to whom they were loaned by WLS. They are versatile humorists appealing to domes of all dimensions



# A Universal Short Wave Transmitter

How to Build a Five-Watt Transmitter of Extraordinary Range and Steadiness which Can Be Used with Receiving B Batteries as a Source of Plate Supply—The Cost is Not More Than Fifty Dollars

By NICHOLAS HAGEMANN

Station 2 KP, Mitchel Field, Long Island

ANY one who has listened to signals on the very high frequencies, on the so-called amateur 40 meter-band, for example, will know that strange things occur there. In the first place, signals do not stay put, but they wobble around, fading in and out, changing in frequency and strength. It is one of the discouraging things about high frequency transmission—but on the other hand it is one of the joys, for one never knows what is going to happen next. The next signal may be from China or Indiana, no one knows. And no one can tell whether the station will sign before he fades out.

Once in a great while a station can be heard that in a steady, unvarying pure note pounds away, perhaps not very loud, but

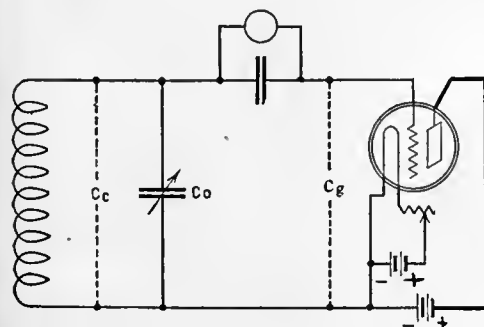

FIG. 1

A conventional input circuit to a vacuum tube wavemeter. The frequency to which such a circuit will tune depends upon the inductance and three capacities as indicated. The resultant frequency is a function of  $L \times (C_o + C_g + C_c)$

unceasingly. Among the medley of notes that fill the 7-megacycle (7000-kc.) band, notes of all sorts, some coarse and raw, practically all of them varying, a clean steady note is like a beam from a lighthouse on a thick night. It gives the receiving operator confidence, for he knows that the signal will not leave him in the middle of a message.

There are several reasons why signals of this sort vary. One reason is fading; no one yet knows how to conquer that natural phenomenon. Another is a swinging antenna, sometimes fifty feet from the ground, at other times nearer or farther from earth. This swinging changes the antenna capacity and naturally changes the emitted frequency. Another

reason lies in a transmitter whose filament or plate supply is not steady. With every change in the conditions under which the tube is operating, the frequency emitted changes.

A transmitter whose frequency is independent of filament or plate voltages is a great boon, and if attached to it is an antenna that is rigidly fixed, unvarying signals will be emitted that will attract any receiving operator's attention at once, especially if it is battery operated so that a pure steady d. c. note is emitted.

The transmitter described in this article has several noteworthy features that should appeal to any constructor of amateur equipment, whether he already possesses a transmitting station or whether he is about to enter this fascinating field.

The great advantage of the present circuit lies in its stability with regard to the frequencies it turns out to an antenna or other load. A little of the history behind its development will reveal its possibilities in this direction.

In connection with other precision radio instruments developed by the Signal Corps for the various branches of the United States Army, a need arose for a frequency meter whose calibration would be independent of many factors, notably tube capacity, differences in plate and filament voltages, etc. In other words, the Army needed a heterodyne frequency meter that could be calibrated with one tube and at

certain filament and plate voltages with the certainty that this calibration would not differ materially when other tubes or voltages were used.

Fig. 1 shows the usual tuned circuit that is used in a vacuum tube frequency meter (wavemeter). The apparatus consists of a coil and a condenser, which is usually variable, the tube, and a grid milliammeter. There are three capacities as shown in this Figure, all of which must be accounted for in the tuning. The coil capacity  $C_c$  is small, of the order of a few micro-microfarads, the condenser capacity  $C_o$  is usually quite large, and the tube capacity  $C_g$  is of the order of several micro-microfarads. Naturally a change in any

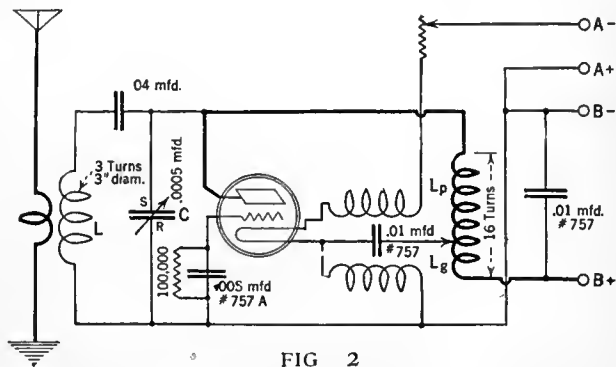

FIG. 2

The circuit diagram of this new transmitter. It is distinct in that the inductance in the tuned circuit is very small and the capacity is very large. For this reason small variations in grid-filament capacity will have little effect upon the resultant frequency. The key is inserted in the B battery negative lead

of these capacities affects the frequency to which the circuit will tune.

The task of developing a new type of frequency meter was undertaken at the Signal Corps Radio Laboratories, Fort Monmouth, New Jersey. The circuit described in this article is based upon the results of the work there. This meter was remarkably stable as regards frequency, due chiefly to the fact that the small grid-filament capacity of the tubes used was bridged across a very large capacity so that variations in the small capacity had little effect upon the total capacity in the circuit.

The circuit performed so creditably as a frequency meter, and it was found that such high voltages and currents existed

**T**HIS article will primarily interest those who already have a short wave receiver and are anxious to build a good transmitter for the high frequencies. This set has the great advantage that the note produced is unwavering and very steady. It should appeal strongly to the amateur experimenter located in the country, where it is difficult to get a dependable source of current supply. The set described here is entirely operated from batteries, an unusual design in short wave transmitters. For those who are interested, a short description of the short wave receiver at present in use at our station 2 GY is shown. We expect to describe a good short wave receiver in an early number. The author has used the term megacycle in referring to transmission frequencies because it simplifies terminology. A megacycle is one thousand kilocycles. It is customary to refer to the frequency of broadcasting and short wave stations in kilocycles, but in short wave work, where the frequency is often of the order of 10,000 kilocycles, the term megacycle is more satisfactory. A government license is, of course, necessary before this transmitter can be used.—THE EDITOR.

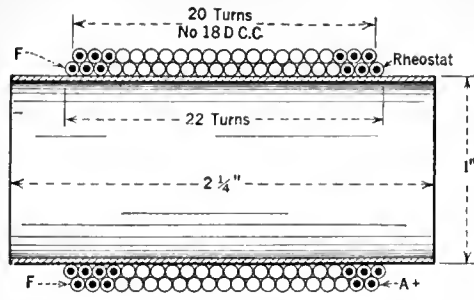

FIG. 4

Details of the filament choke coils. There is no trick whatever about the construction. Both coils are on this tube, one to be inserted in each filament lead

in the tuned circuit, that its value as a transmitting circuit soon became evident. It was then designed to operate at 3748-2998 kc. (80-100 meters), on low power. At these frequencies, a change of 150-400 volts on the plate of the tube produced no greater change in frequency than 800 cycles and corresponding differences in grid-filament capacity and filament voltage produced very little difference in the frequency of the tuned circuit.

AN EXCELLENT TRANSMITTER CIRCUIT

ANY one who has listened on the high frequency amateur bands 3.5, 7, and 10 megacycles, (3500-10,000 kc., 80-30 meters) will appreciate this advantage. With a d. c. plate supply, say from B batteries, a pure unvarying note will arrive at a receiving station and where is the amateur who would not pass by a dozen powerful but fluttering notes for one that is steady though not so powerful?

As actually designed for transmitting service, the coil in Fig. 2 is a single loop of heavy wire and, with a five-watt tube, currents as high as eight or more amperes were obtained in the loop. As designed here for amateur use, the coil L consists of a few turns of heavy wire coupled

to an antenna-counterpoise system. With medium power, large currents are induced in the antenna, the actual value of course depending upon the relation between the

fundamental frequency of the antenna and the actual frequency used for transmission, as well as upon other factors.

As constructed by the writer, a consis-

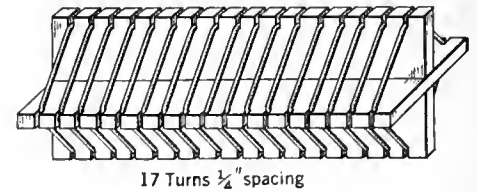
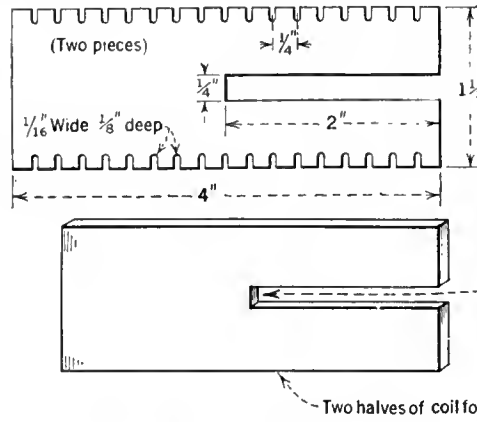

FIG. 5

Details of the Lg-Lp coil and its construction. This is somewhat different from the usual transmitter inductance. A good view of it is shown in Fig. 3 and in Fig. 6

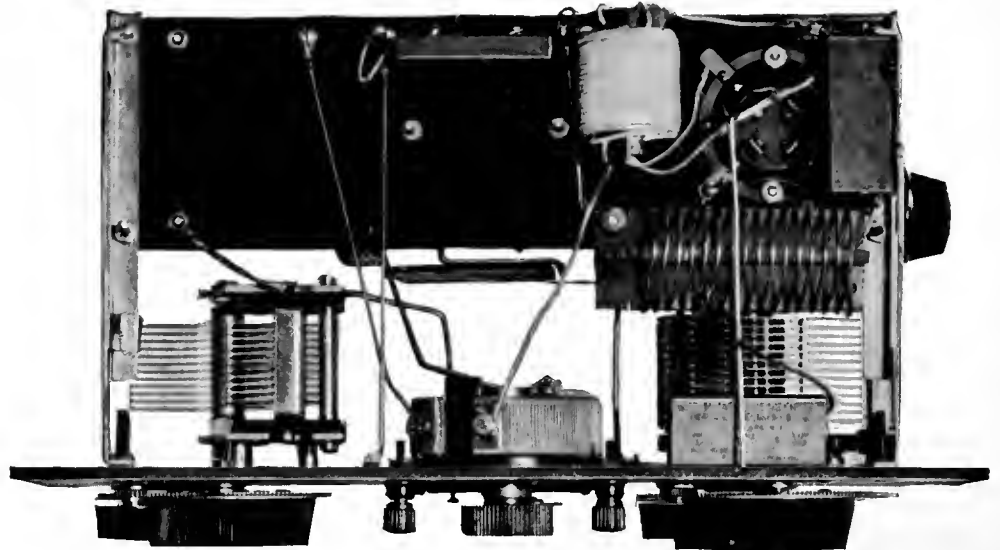

FIG. 6

RADIO BROADCAST Photograph

A view of the transmitter from below the sub-panel showing the disposition of the choke coil and the criss-cross inductance. The short, direct, and heavy leads for the radio frequency paths are clearly shown. The variable condensers shown are a General Radio 247 .00044-mfd. and DXL .0005-mfd.

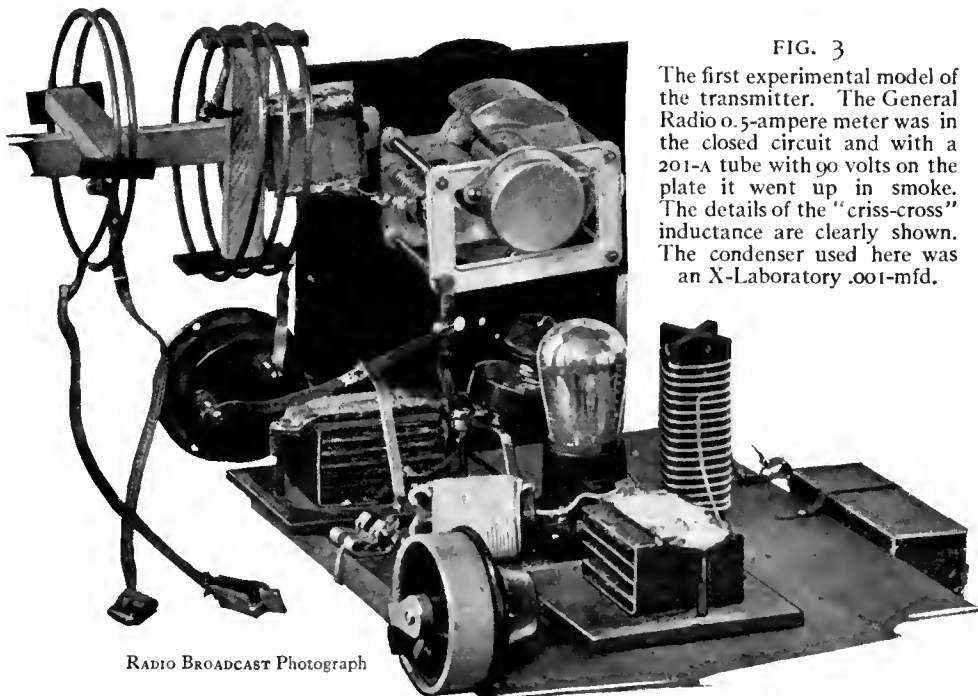

FIG. 3

The first experimental model of the transmitter. The General Radio 0.5-ampere meter was in the closed circuit and with a 201-A tube with 90 volts on the plate it went up in smoke. The details of the "criss-cross" inductance are clearly shown. The condenser used here was an X-Laboratory .001-mfd.

tent day range of 800 miles was obtained in the so-called 40-meter band with a UX-210 tube with 350 B battery-volts supplied on the plate. The currents and voltages in the loop circuit are so high that higher powers require great care, and at the present time, the writer is not prepared to give dimensions of the parts to be used if more than 50 watts input to the tube are employed.

The constants of the various condensers are shown on the diagram of connections in Fig. 2 and the general layout of such a transmitter may be seen from the photographs accompanying this article. The tuning condenser must have wide spacing between plates and have a large capacity, since the inductances used in the set are quite small. The larger this condenser C, the smaller will be the detuning effect of varying tube capacities. The by-pass condensers and .04 mfd. stopping condenser in the L-C circuit must be able to stand

RADIO BROADCAST Photograph

at least 1000 volts, and for this reason transmitting condensers, are suggested. In the writer's opinion it always pays to buy good by-pass condensers since the life of tubes frequently depends upon them. Mica condensers of the correct capacity may be found in many automobile spark coils.

Coil L consists of three turns of No. 10 bare copper wire wound on the cardboard case of a dry cell and then allowed to expand until the diameter of the coil is about  $3\frac{1}{2}$  inches. The antenna coupling coil is a single turn of the same wire and about  $2\frac{1}{2}$  inches in diameter.

The filament choke coil is wound in two layers on a bakelite or hard rubber tube  $1 \times 2\frac{1}{4}$  inches. The bottom layer has 22 turns, the top 20 and any size of wire may be used, although No. 18 d. c. c. is about the best from the standpoint of resistance. One layer is wound on over the other as shown in Fig. 4 and the connections to the tube as illustrated in the figure should be short.

The other inductance, Lg—Lp, is constructed of two hard rubber cross pieces as shown in Fig. 5 and in the set illustrated about 17 turns are correct for the 7-megacycle (40 meter) band. Varying the tap along this coil controls the plate current taken by the tube and with a given antenna current, this plate current should naturally be as small as possible. The tap with a UX-210 tube should lie about six turns from the



FIG. 7

The panel view of the completed transmitter

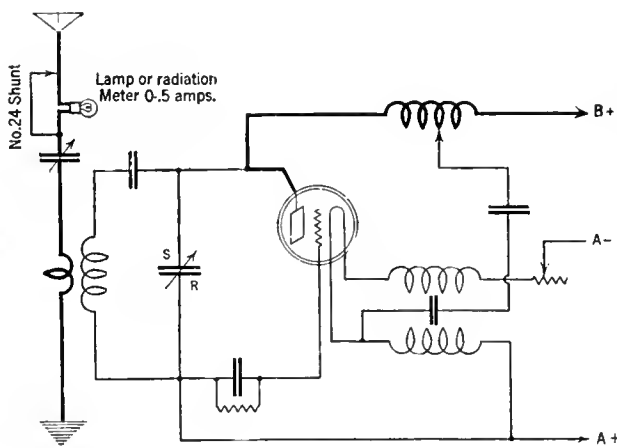

FIG. 8

A method of indicating when the transmitter is in resonance with the antenna-counterpoise system. The length of the shunt varies with the current passing into the antenna and with the amount of current that the indication device will stand without burning up. About one foot may be used and one point of connection made variable so that more or less antenna is included

plate end. The actual construction of such a transmitter is remarkably simple. There are few pitfalls to avoid, the chief one being long, poorly made connections and condensers that will not stand the voltage.

After the instruments are wired up, a receiving tube should be placed in the socket and about 90 volts used on the plate. Then the transmitter should be brought near a receiver that will tune to the frequencies to be covered by the transmitter and the latter tuned. It will be found that, with the constants used in the diagram in Fig. 2, that the entire 7-megacycle band can be covered with the tuning condenser C at from 80 to 100 degrees. This is purposely done so that the condenser will be used at its maximum value. If desired, a fixed air condenser may be made with a small two- or three-plate variable placed across it. Then the frequency band may be covered with more degrees of dial rotation.

The variable condenser, C, should be turned to maximum and the lowest frequency found by tuning the receiver to it, and then the condenser capacity decreased until the tube stops oscillating or until the condenser approaches its minimum capacity. The transmitter illustrated in Fig. 3 oscillated perfectly until 10 megacycles (10,000 kc., 30 meters), was reached. It is probable that a given set could be made to cover two of the amateur bands, either the 15- to 7-megacycle (15,000 to 7000 kc.,

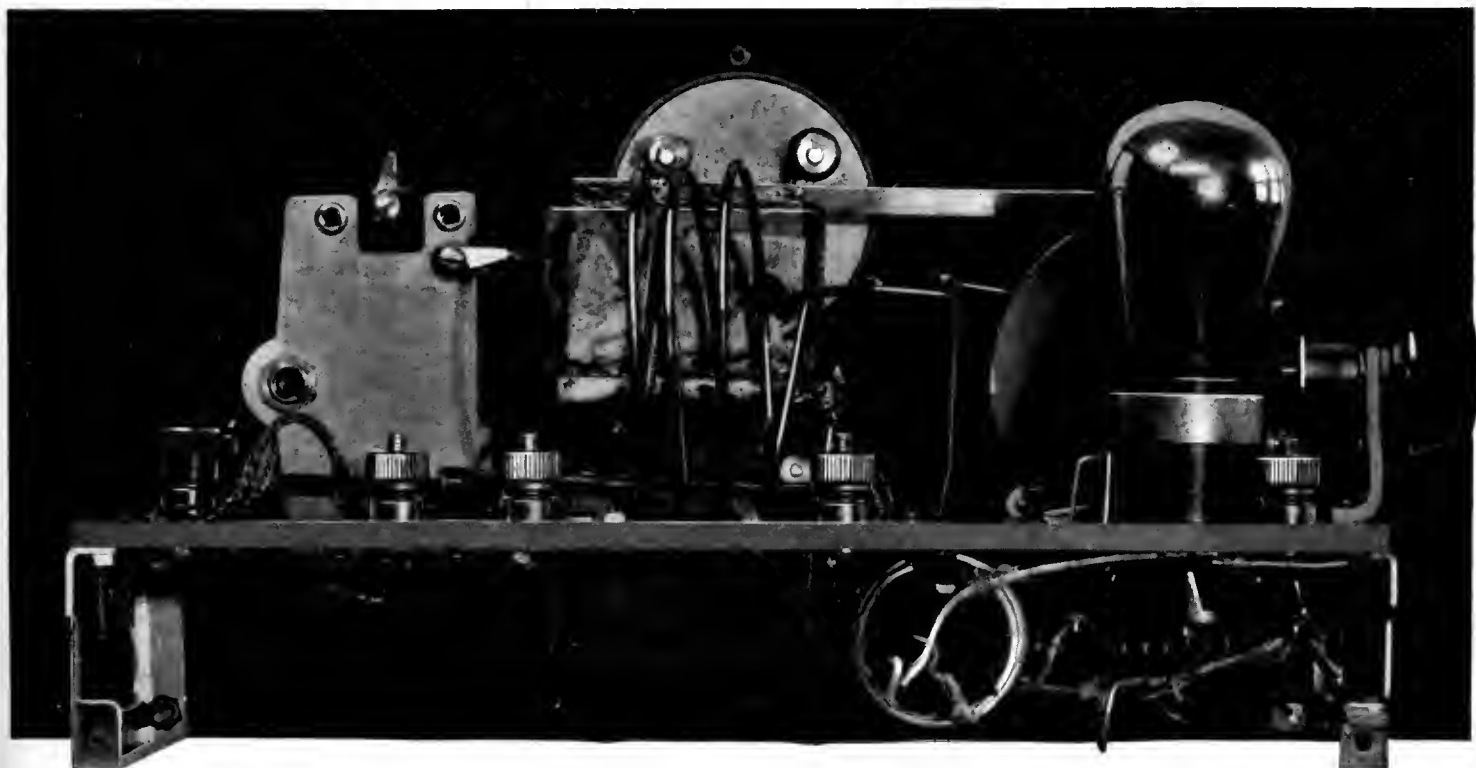

FIG. 9

RADIO BROADCAST PHOTOGRAPH

Looking behind the panel of the transmitter, the three turn coil L and the single turn of antenna coupling inductance are very much in evidence

The Facts About This Transmitter

FREQUENCY RANGE: 6.5 to 8.5 megacycles  
 WAVELENGTH: 35 to 40 meters  
 ANTENNA: Single Wire, 35 feet long  
 COUNTERPOISE: Single Wire, 35 feet long, as near to the ground as possible  
 SOURCE OF PLATE CURRENT SUPPLY: Receiving B Batteries Rectified a.c. Motor generator

TUBES WHICH MAY BE USED

	A VOLTAGE	B VOLTAGE	SENDING RANGE (MILES)
UV-201A or similar independently made tube	6	200	50
UX-112	6	200	100
UX-210	7.5	400	800

If B batteries are used, so-called "heavy duty" cells should be purchased. This transmitter when properly operated, will have a current drain of about 35 milliamperes, which is about equivalent to the demand made by an 8-tube super-heterodyne. Owing to the fact that, in the transmitter, the keying of the circuit interposes an intermittent drain on the B batteries, the drain on them is not nearly as heavy as would ordinarily be supposed.

LIST OF PARTS USED IN CONSTRUCTING THIS TRANSMITTER

One panel, 7 inches by 14 inches by $\frac{3}{16}$	1.25
One General Radio condenser .0005-mfd. without gears (or other good receiving condenser)	3.25
Two General Radio dials with verniers	5.00
One Centralab 100,000-ohm variable resistance (Bradleyohm or Royalty B may be used)	2.00
Two Benjamin brackets,	.70
One .00025-mfd. variable condenser (any reliable make)	3.00
One socket for UX tubes	.65
Two Dubilier .01-mfd. condensers type 577	5.50
One Dubilier .005-mfd. condenser type 577	2.25
One General Radio or Weston radiation meter	8.00
One General Radio rheostat (or similar which will handle up to 2½ amps)	2.25
Eight heavy duty binding posts	.56
One sub base 3½ inches by 11½ inches	.75
Two hard rubber cross pieces	
One bakelite choke coil tube 1 inch by 2¼ inches	
One Dubilier .04-mfd., 1000-volt stopping condenser.	2.75
One plate milliammeter, range 0-100 (Weston or Jewell)	8.00
One UX tube	2.50-6.50
Total not over	\$50.00

20-40 meters), or the 7- to 3.5- megacycle (7000-3500 kc., 40-90 meters) band.

After the maximum frequency range has been determined, the constructor can calibrate the condenser in megacycles, kilocycles, or wavelengths as desired.

THE ANTENNA

PROBABLY the simplest antenna to be used with this transmitter is a single wire 15 to 25 per cent. lower in fundamental frequency than the actual frequency to be emitted. A series condenser is then used to bring the frequency to the desired value. For example, on the 40-meter band, a single wire 12 meters (37 feet) long and a similar counterpoise will have a fundamental wavelength of about 50 meters which can easily be reduced to 40. The antenna current will be lower under these conditions than if the antenna were being excited at its fundamental frequency, but

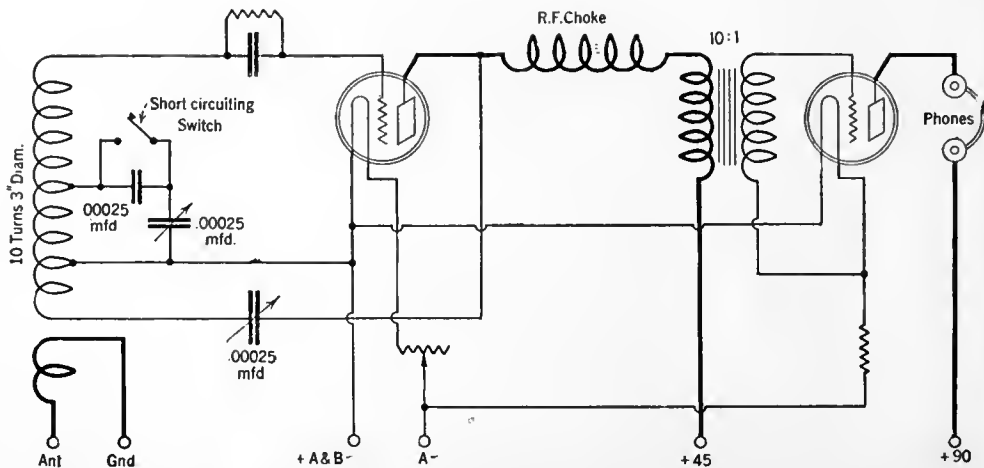
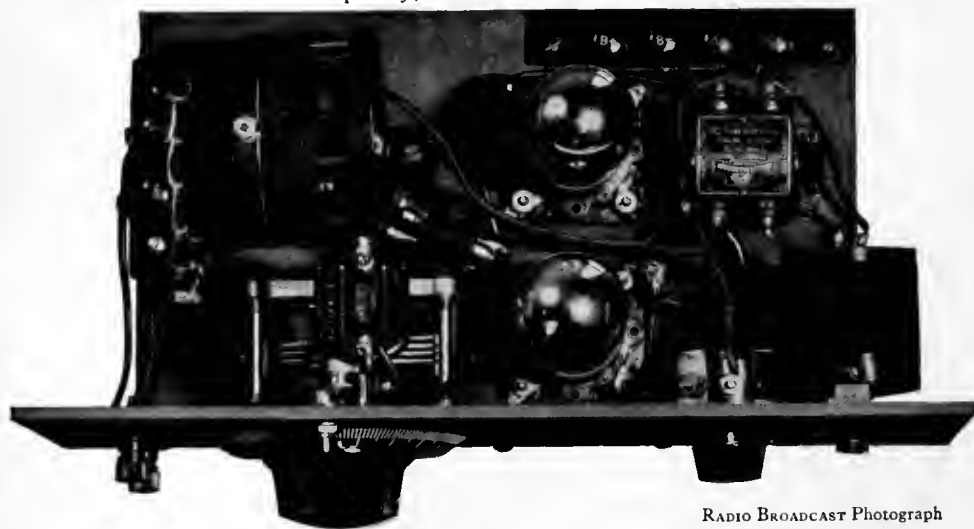

FIG. 11 The connections for the receiver. Interchangeable coils enable this receiver to cover all of the amateur bands



RADIO BROADCAST Photograph

FIG. 10

A photograph of a receiver now in use at 2 GY which employs the circuit familiar to all amateurs, known as the capacity feed-back. The condenser is a five-plate Bremer-Tully and the interchangeable coils are wound on Bruno forms. The transformer is an All-American, ratio 10:1

since the radiation resistance is higher above the fundamental frequency, greater efficiency is obtained.

Ribbon antenna wire will lower the ohmic resistance and if the wire is twisted, motion caused by the wind will have little effect on the frequency transmitted. Good copper ribbon may be obtained from an old Ford spark coil primary. It is highly important that the antenna be thoroughly insulated, preferably with Pyrex and that it be taut.

In the photographs illustrating this transmitter, a General Radio half-ampere radiation meter is shown. This will handle the output of a 201-A, a UX-112 or even a UX-210 type tube, unless a very small antenna or greater plate voltages are used. Then a copper wire should be shunted across the meter so that it will not be burned out.

In actually tuning the transmitter to the antenna, the antenna series condenser

and the tuning condenser C should be varied until the greatest radiation on the desired frequency is secured. At this point, the plate current should be adjusted by varying the tap on the Lg-Lp coil until it is smallest, consistent with good radiation.

If the constructor desires only one meter, and only one is really necessary, he may use a plate milliammeter with a range of 0-100 and a flash light bulb. The milliammeter is placed in the negative B battery lead, and the flash light is placed in the antenna-ground lead. When maximum current flows in the antenna, the lamp will be brightest. Here, again, care must be taken not to burn out the indicating device. A 6-volt lamp or smaller with a shunt wire may be used for this purpose. Fig. 8 shows the proper position of the indicating device.

After the constructor is thoroughly familiar with the operation of the transmitter, greater power may be applied to the receiving tube, or a power tube can be employed. It must be understood, however, that the voltages in the tuned circuit are very high and that as soon as heavy currents begin to flow, both condensers must be able to stand up. If the mica condenser passes more than five amperes it will probably get hot and then trouble begins. The remedy is to use more condensers in a series parallel arrangement—but before that time, enough distant stations should be worked to satisfy any one.

In the writer's station 2 KP at Mitchel Field, Garden City, Long Island, and at 2 GY, located in the Radio Broadcast-Eveready experimental station, no difficulty at all has been had in maintaining schedules with stations 800 or more miles away. On several occasions, a 201-A tube has been used, and with 180 volts of stand-

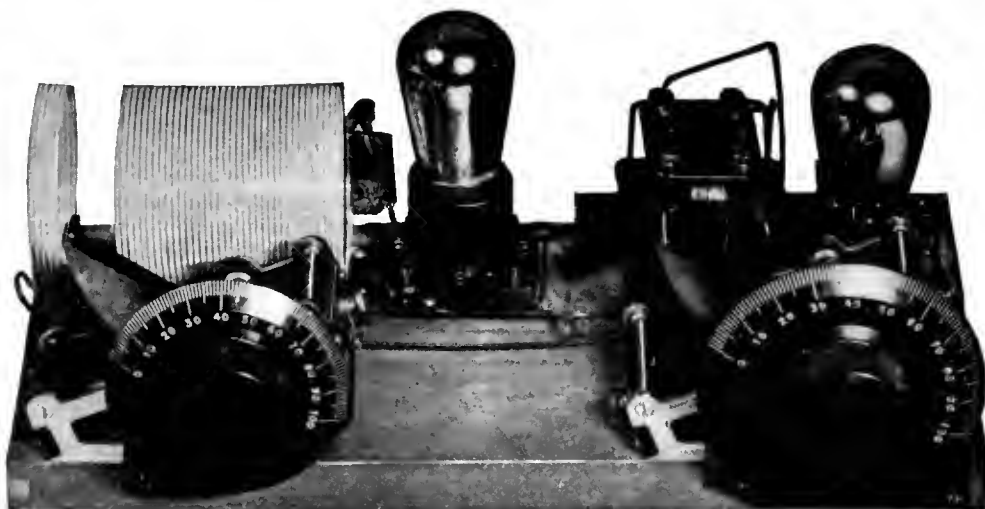

RADIO BROADCAST Photograph

FIG. 12

A short wave receiver used at 2 GY on the so-called 80-meter band. Karas orthometric condensers are used for both feed-back control and for tuning. The coils shown are made by Hammarlund Manufacturing Company. Other coils may be quickly inserted in the circuit so that higher or lower frequencies may be received

ard receiving B batteries on such a tube, successful transmission of several messages to Philadelphia, 100 miles away, has been accomplished. This represents a power input of less than one-half watt! At the Mitchel Field station, a standard input of 19 watts has been used on a five-watt tube and all districts in the United States have been worked.

The transmitter illustrated in this article is now operating at 2 GY, and the operators there would appreciate reports on signal reception.

THE RECEIVER

THE receivers used at 2 KP and at 2 GY are very simple and are fashioned according to the well known amateur capacity-

feedback circuit shown in Fig. 11 and illustrated in Figs. 10, and 12. Complete description of such a receiver will be included in the Radio Broadcast-Eveready short wave experiments series of articles. The photographs and circuit diagram show enough detail so that the home constructor should have little difficulty in actually constructing such a receiver. A fixed condenser is placed in series with the tuning condenser so as to spread out the stations over a greater number of degrees on the dial. This may be shorted when not wanted. The switch is shown in Fig. 12.



FIG. 13

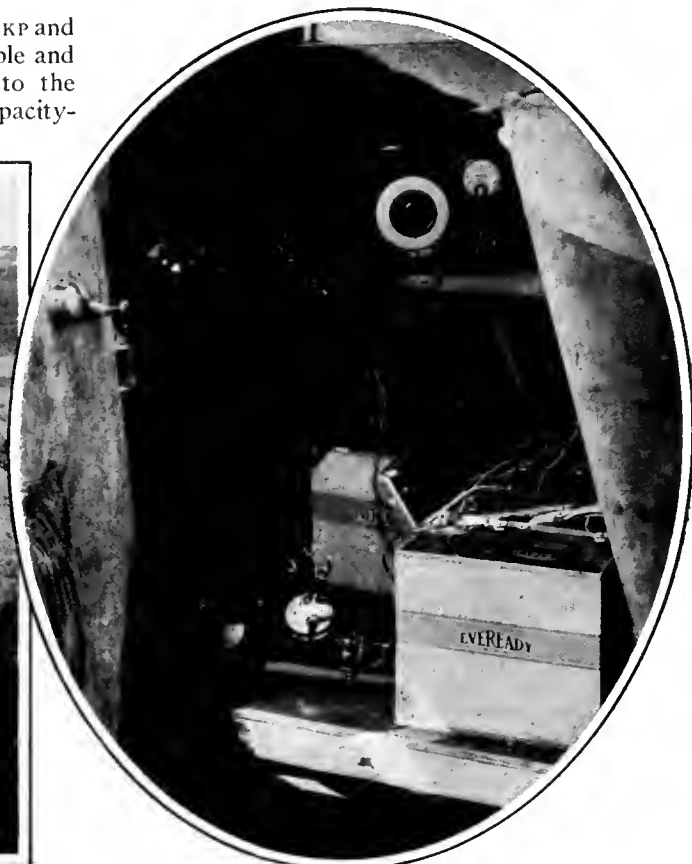

RADIO BROADCAST Photograph

Twelve miles from the home station 2 GY. This transmitter with an input of about 6 watts on an antenna 7 feet above ground put strong signals into the receiver at 2 GY. The oval insert shows a close-up of the automobile installation, operated from B batteries

# AS THE BROADCASTER SEES IT

by CARL DREHER

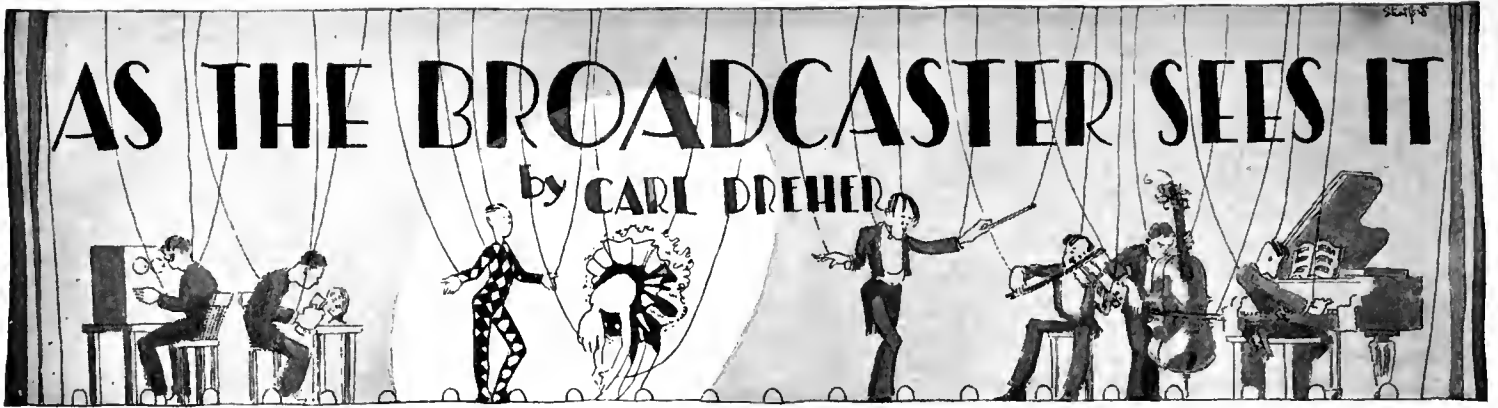

Drawings by Franklyn F. Stratford

## Who Shall Judge the Quality of Our Broadcasting Stations?

AS THE years of broadcasting reach a dignified sum, and similarly the money expended on programs, the question, "Who shall be responsible for the musical quality of the station output?" is being raised at more than one station. That is, who shall say that there is not quite enough cello in this trio or that quartet, or that the woodwinds are a trifle too prominent in some symphony orchestra (as broadcast), or that the accompaniment to a vocal solo might be a little less prominent without injury to the pianist or his relatives. Shall it be the operators, who have been doing it heretofore? Or shall the job be handed over to professional musicians?

The opinion among the best informed and forward looking broadcasters seems to be that this responsibility should be loaded on to the shoulders of the musicians, rather than the operators, but with certain qualifications. Not to any old musicians, but to men trained in both music and broadcasting. And to these, with reservations as to the no man's land between the program side of an event and the technical aspects of transmission.

For example, when carbon microphones are used, there is always liability to blasting. This phenomenon is a technical matter. (See "Microphone Placing in Studios," September, 1925, RADIO BROADCAST.) The operators and engineers of broadcasting stations know more about it than the average musician does. Furthermore, they have instruments (d.c. milliammeters in the battery circuits of carbon transmitters), which afford an additional check, showing up both incipient and severe blasting. Some microphones are more susceptible to this difficulty than others. Clearly, therefore, this is a matter wherein the musical critics in the studio need the aid and counsel of the technical experts.

As a matter of logical expectation, skilled musicians should be better able to balance an orchestra to the utmost nicety, and to per-

form similar delicate musical tasks, than men who grew up with voltmeters and R. M. S. voltages and curves of tube characteristics. That is, as a class. There will be exceptions, of course. Some broadcast operators with exceptional musical taste or experience are capable of turning out a better job on the air than all but a few musicians. The ideal combination is a first-rate engineer who is also a first-rate musician, a sort of fusion of Charles P. Steinmetz and Jean De Reszke, for example. Try and get

him. Having done that, try to make him work in a broadcasting station for \$3000 a year. When we poor devils who, for our sins, have been set to running broadcast stations—when finally we have completed our penance, and the last milliampere has quivered through our nerves, then, operating the broadcasting stations of heaven, we shall have paragons like that working with us. Oh for those celestial studios and control rooms, where sopranos shall never shriek, where the "mikes" shall cease from blasting, and the grid milliammeter be at rest! But here on earth we must take men and materials as we find them, and there is no use looking for such engineer-musical genius combinations as those we have been dreaming about. Their very qualities are antipathetic.

The basis for employing musicians in this phase of radio transmission is simply the old motto: Shoemaker, stick to thy last. But in citing that phrase—and I do so with approval and have thrown what influence I have toward the musicians in this friendly controversy—I want to add that I am proud of the part engineers and operators have played in the musical development of radio broadcasting. Lifted abruptly, most of them, out of the purely technological and non-artistic labors of radio telegraphy, they quickly adapted themselves to unfamiliar conditions, learned what was needed, developed new aptitudes, and turned out a good job in many cases, and a brilliant one in some. And a rotten job in other instances, it must be added, but to the custodians of the tin horn and dishpan stations I refuse to grant the name of radio operators and engineers. It was a fine example in adaptation. Radio men are not a stationary lot and they move fast when necessary. If they ever have to do it again, in some other connection, depend on it that you will not find them lacking. Those of us who live to see the complete development of radio motion pictures may view a similar incursion of radio men into the field of pictorial art. But inherently such in-



"IF MISS AMERICA ARRIVED, HE WOULD NOT STOP LISTENING"

vasions are self-limiting in their nature. Invariably the investigators and research men improve the equipment to such an extent that the most artistic interpretations become possible, and the aid of men with an artistic background becomes essential for the best possible results. And in broadcasting we are not going to be satisfied until we get to the point where a man listening to a loud speaker will not be able to tell for the life of him whether he is hearing the original performance or a reproduction. That point we may not be able to reach, but we shall certainly aim at nothing less. And anybody who can help us, whether he is a musician or a street-cleaner, is welcome.

The musician who undertakes work in broadcasting should realize, on his part, that he must add something to his technique, as the operators have added something to theirs. I have myself seen competent orchestra leaders and soloists—competent, that is to say, as leaders of orchestras or performers on special instruments—whom I would not trust on the musical end of a 10-watt station with an audience of two dozen. They were incapable of listening closely, in the first place. Have you ever seen a good broadcast technician listening to the output of some piece of equipment? He goes into a kind of trance. If Miss America came and pirouetted before him in a one-piece bathing suit, it is doubtful if he would pay any attention to her. Frequently he stops breathing. With such concentration one is likely to know what one is hearing. These musicians I am writing about did not go to all this trouble. They would listen for a few seconds, snatch the phones off their ears, rush over to the orchestra, and make some change. After touching the telephones to their ears once more, they found it necessary to alter something else. With the third trial, the orchestra—the men by now in active rebellion, was returned to the first position. This was now pronounced, "Excellent!" "Wonderful!" which it was not. After a few minutes the virtuoso realized this, although he was quite incapable of making the correct diagnosis. Once again he began making changes. By this time every man in the ensemble was ready to come to blows with him. In another minute the tension would have risen to that point, but at this juncture the operator took charge, moved the microphone a foot back in the right direction, getting rid of the violin blasting which was causing all the trouble, and ended the argument.

Why should some musicians, who are perfectly competent to read a score, give their individual interpretation, control an orchestra, and play a few instruments, be unable to listen to a loud speaker giving a fairly faithful reproduction and tell how it can be improved? I don't know, but presumably they overlook the differences between even the best reproduction and the original in the present state of the art, and, in an unfamiliar situation, they are unable to concentrate to the necessary degree. There are also temperamental obstacles. I am not one of those who look on all artists, writers, poets, and musicians as subjects for the psychopathic ward; I believe that as a class they do not go crazy much oftener than manufacturers of corrugated ashcans and cheese-paring machines, and that in any state they are more interesting to talk to. But I presume that the average musician is somewhat more nervous than the average engineer, because in his profession nervousness is not discouraged as much as in engineering. And there is not

much room for nervousness in broadcasting. The business itself contains enough tension without any contributions from the participants. One needs sharp ears and a cool head.

It is to be hoped that no personal rancor will enter into any readjustments that must be made. It is merely a matter of doing the best possible job. There is room enough for everybody involved. If it were not for music and musicians there would be little use for radio broadcasting, and if it were not for broadcasting some musicians would be out of jobs. There is also dignity enough to clothe everyone, it is to be hoped. The operator's function can never be relegated to a place of unimportance. Some people seem to think that the term "operator" is applied only to persons of no great consequence or skill. This is a mistake. The term is a very broad one, applied to a variety of workers. Some are unskilled and others must be extremely intelligent and capable. It is not generally known that in medical literature the surgeon who performs an "operation" is referred to as the "operator." If a man who daily holds the lives of other men in his hands does not mind being called an "operator," surely there is nothing invidious about the expression. But why dwell on such trivialities? Radio men are more interested in radio.

### Credit Where Due

MANY a time and oft I have felt called upon to comment sourly on the contents, make-up, and editing of the newspaper supplements devoted to radio, especially those in New York, which meet my dour eye most often. As a whole, they seem to me to foster superstition, sensationalism, and questionable information, to emphasize all that is transitory, childish, and unoriginal, and to neglect the substantial and scholarly elements in the art. There are, of course, some exceptions. Mr. Zeh Bouck's weekly column, "What Are the Air Waves Saying?" in the New York *Sun*, stands out in this group. But it is an oasis in the desert. Most of the sheets are dull, obvious, full of unchallenged press agents' concoctions,

and perhaps dubious advertisements. Heaven knows I have a lot to learn about radio, but, with my right hand raised and my left laid solemnly on a copy of Zenneck, I declare that I have never learned anything from newspaper radio sections, with lamentably few exceptions.

It is with the more pleasure, therefore, that I would call attention, somewhat belatedly, to the New York *Times* Sunday Radio Section of September 13, 1925. It was a first class journalistic job. It was brought out during the week of the two big radio shows in New York, with, presumably, the same fundamental objects as those of other radio sections and supplements. But this one set about its task by filling the space not occupied by advertisements with useful information, authoritative articles, and good sense. Among the authors who contributed were Orrin E. Dunlap, Jr., A. Hoyt Taylor, E. F. W. Alexanderson, E. E. Free, J. A. Holman, David Sarnoff, Alfred N. Goldsmith, Kolin Hager, C. B. Popenoe, E. H. Jewett, Lee De Forest, J. H. Dellinger, E. C. Mills, Martin P. Rice, H. P. Davis, W. H. Priess, David Grimes, J. D. Freed, and J. H. Morecroft. I spent several hours reading it, and they were profitably spent. I have never met the editor of the *Times* weekly radio section, nor does the paper subsidize me, but, having knocked radio newspaper supplements in general, I feel bound to congratulate that editor and that paper for their achievement

### Among the Broadcasters

#### WHAZ

ACCORDING to all accounts and evidence on hand, WHAZ, the broadcasting station of the Rensselaer Polytechnic Institute at Troy, New York, has started its fourth year on the air without showing the effects of age. WHAZ, it will be remembered, is under the direction of Prof. W. J. Williams, who defended the low power side in the super-power debate which lately raged in these columns. Mr. Rutherford Hayner is program director and announcer.

Station WHAZ is housed in the Russell Sage Laboratory of the Institute, with the towers on the roof. The location overlooks the Hudson River at the head of tidewater navigation, 150 miles north of New York, and it appears to have electrical as well as scenic advantages, for the station has attained enviable ranges for a standard 500-watt installation. No doubt a part of this is also due to the operating personnel and management, which, in an engineering school, may be expected to turn out a top-notch technical job. As early as February, 1923, the station was heard in New Zealand, two-fifths of the way around the earth. It has also been picked up repeatedly in France, Belgium, Scotland, England, Alaska, Panama, South America, the Pacific Islands, the Far East, and of course all over the United States and points near by.

The R. P. I. station is on the air but once a week, on Monday evenings. It is the gift of the Roebing family to the Institute, and is operated naturally, on strictly non-commercial lines, in contrast to the blatant advertising of some of the smaller and irresponsible stations in the state. There are popular monthly programs by the students' symphony and dance orchestras, and musical clubs. The first minstrel show is said to have been broadcast from WHAZ's studio. One of its programs that is well and favorably



"I SWEAR—WITH MY HAND ON A COPY OF ZENNECK"



THE ANTENNA AT STATION WHAZ

remembered is the commemorative Joseph Henry broadcast, in honor of the American electrician and physicist, whose work in electromagnetism prepared the way for many later developments of the telegraph, telephone, and radio. Other educational broadcasts have found a place in the programs, including practical and non-technical talks by members of the faculty on subjects of current interest in the scientific and engineering field.

Of course Rensselaer does not limit its radio activities to the operation of WHAZ on its frequency of 790 kc. (379.5 meters). As an engineering college in which electrical and communication engineering are among the major courses, the school employs numerous transmitting and receiving sets covering a very wide range of frequencies. Among the curiosities are a DeForest radiophone set which Professor Williams demonstrated to the students in his courses as long ago as 1910, and a Marconi wireless telegraph set dating back to 1902, containing one of the original coherers.

Many radio amateurs both in this country and abroad are familiar with the call letters of the Rensselaer experimental stations, 2 XAP, 2 SZ, and 2 CDC.

### WIBO

NEWSPAPER reports tell of an accident in the generator room of WIBO in Chicago, when L. G. Rasmussen came into contact with a high tension wire during the evening program on September 17th, and was severely injured. He was taken to St. Francis Hospital in Evanston.

The operator's injuries were sustained when the gold frame of his eyeglasses came into contact with a live lead. The frame of the glasses fused immediately and the resulting arc burned the face, hands, and chest, of the victim. The station had to be shut down before he could be released.

This unfortunate occurrence should be a warning to other broadcast operators who have so far escaped. Familiarity breeds contempt, and men who handle high tension machinery every day are apt to forget that contact with it at the wrong time may prove fatal. Particularly with the higher powers and voltages which are coming into use in broadcasting, additional precautions are the order. One good trick is to work on the equipment, where possible, with only the

right hand, leaving the left in the hip pocket on that side. The logic of that is the fact that if one is caught, the current will pass down the right side of the body to ground, instead of through the relatively low resistance arm-to-arm path which includes the heart region, the great splanchnic ganglion, and other primary nerve centers and organs. Secondly, never lay a hand heavily on a portion of a circuit which may be alive, without first flicking it lightly with one finger, which will give you a chance to disengage if there is anything wrong. The same precaution should be used in connecting two wires which may cause a short-circuit. Incidentally, the arc following a short circuit, if the potential difference is not too high, may be blown out with a puff of breath. Thirdly, every station should contain red fibre signs "Man working on this circuit—do not close," or some similar formula, to be attached to open switches when an operator is working on a "killed" circuit. These tags should be signed, and the rule is that no one but the man who attached the tag may remove it. Fourthly, keep away from the sets when there is a local lightning storm. And finally, all operators should be familiar with first-aid practice and methods of resuscitation, and in the larger stations it is a good thing to have a drill along these lines once a month.

### KFI

ACCORDING to somewhat vague reports which have reached us, the engineers at KFI have been

experimenting with varying amounts of acoustic damping in the studio. They started, it seems, with the usual idea that a studio should be made as "dead" as possible, the ideal studio being one with entire absence of reverberation. This opinion is now being modified, and the object of the experimentation at KFI is to ascertain how much reverberation is to be allowed for best results on the air. This quality seems to be like salt; you don't want much of it in the goulash, but a little is almost indispensable.

### KGO

STATION KGO in San Francisco tackled a big job at the Municipal Auditorium, broadcasting the oratorio "Creation," given by the city of San Francisco with a chorus of 300, 65 players in the orchestra, and three soloists. This was possibly as big a pick-up undertaking as any one in the West has tried. There was also an organ, we must not forget to mention.

The space occupied by the chorus and musicians was 48 by 80 feet, and the organ pipes rose 50 feet in the rear. The solution of the pick-up problem was found in the use of condenser microphones, which have no hiss or internal noise, when they are in proper working order, and can be used to pick up sounds within an extreme range of volume. One of these mechanisms, about three inches in diameter and ten inches long, was suspended twenty feet over the heads of the performers, carrying most of the orchestral and choral tone. A second condenser was used for the soloists, about five feet in front



"HIGH TENSION EQUIPMENT . . . MUST BE HANDLED GINGERLY"



of them. As the soloists stood in front of all the other performers, this microphone was well removed from the rest of the musicians and singers.

By all accounts the transmission was first-class. Even the slight rustling sound as the audience turned the pages of the programs in unison, while reading the words of Haydn's masterpiece, was distinctly heard on the air.

Some years ago WEAF broadcast the "Messiah" oratorio from Carnegie Hall in New York, also turning out an excellent piece of work. And wjz in the same city did Beethoven's Ninth and Verdi's "Requiem" last summer, outdoors, with an orchestra of 110 men, five soloists, but with a smaller chorus—200 in number. We should like to hear from other broadcasters regarding large pick-ups they may have tried, and their estimate of the results.

CKCO

DR. G. M. GELDERT of Ottawa, the president of the Ottawa Radio Association of 600 members which operates CKCO out of pure interest in broadcasting, was in New York during the week of the radio expositions, looking over the field and visiting the metropolitan broadcasters. The Doctor is a prominent physician of Ottawa. If I knew as much about cyanosis and streptococci as he knows about microphones and audio frequency, I should feel proud of myself.

Studio Microphone Placing—Further Consideration

THE interest shown in the problems of microphone placing in the studio has been sufficiently marked to warrant interrupting the progress of our technical series for broadcasters to give further discussion of this important subject.

Among the letters received is one from Mr. Ralph S. Hayes, of Ardmore, Pennsylvania, reading as follows:

While I have never had anything to do with broadcasting, nevertheless, from a study of speech, music, and acoustics, I would like to submit some ideas relevant to the article, "Microphone Placing in Studios." (In the September issue.)

1. I notice the basses and percussion instruments are placed comparatively far from the microphone. Should it not be just the opposite on account of the fact that the bass tones are invariably attenuated more in their transmission through the station amplifiers and receiver amplifiers?

2. It is a proved fact that the basses carry much of the pleasant roundness of music—as well as the energy.

3. The excess of energy in the lower pitches— isn't it the usual cause of the "blasting" mentioned?

4. Wouldn't a better placement be—

(a) microphone farther away from orchestra;

(b) basses closer to microphone than trebles.

5. A possible objection to such an arrangement would be carbon frying, but it either need not be carried to such extremes, or a condenser transmitter could be used. At any rate shouldn't you aim toward "basses front" instead of "basses rear"?

As to Mr. Hayes's first point, I believe the general feeling among broadcast engineers is against trying to compensate for losses of essential frequencies in the audio channels of transmitters and receivers, by exaggerations in the pick-up or elsewhere. As far as the transmitter is concerned no such losses should be tolerated in any considerable degree. Plenty of stations find it possible to send out their stuff flat be-

tween 60 and 6000 cycles, and those who haven't learned how, should acquire that ability quickly, while they still have an audience. As for receivers, what degree of deficiency is to be taken as a criterion? In some cases the loss of low frequencies is so complete that a slight gain in bass at the start would not help appreciably. Again, just as many receivers lose the higher frequencies as well as the lower, passing only a band of three octaves or so in the middle. Following out Mr. Hayes's theory, there is just as much reason for emphasizing the violins at the start in order to retain the natural quality of the treble strings with their wealth of overtones. This brings us to the second point.

It is true that loss of bass notes makes music sound "tinny," "canned," and disagreeably sharp, and strident. But dropping the band from 3000 cycles up is quite as bad. All the instruments merge into a dull, soft, lifeless harmony, like a bad organ heard with one's ears stuffed full of cotton. Finally, receiving sets are now on the market which are capable of reproducing sounds sensibly as they are broadcast, and the number of these sets will naturally increase. They are the only safe criterion. It is obviously a saner procedure to work with a horizontal frequency characteristic all along the line.

Answering the third point, I believe that blasting is most frequent with instruments possessing a steep wave front. The cornet is about the worst offender. Cutting off the higher frequencies tends to reduce blasting. One type of carbon microphone, which cuts off on the high end at about 2500 cycles, is relatively free from blasting, but the loss of intelligibility and tone brilliancy makes the net result undesirable in high quality work.

To point 4a, I should answer "No," for reasons well stated by Mr. Julius Weinberger, one of the leading electro-acoustic and broadcast engineers in the East. ("Broadcast Transmitting Stations of the Radio Corporation of America." *Proc. Institute of Radio Engineers*, Vol. 12, No. 6, December, 1924.) Mr. Weinberger writes:

It may appear that less work would have to be done with regard to proper placing of the performers if the microphones were not used relatively close up, being placed instead, for example, at the opposite end of the studio. In the latter case, the relative distance of the microphone from each of the several performers would be nearly the same and there would apparently be less of a problem so far as proper "balance" is concerned. However, it has been found that this cannot be done for a number of reasons. First, the farther away the microphone is from the performers, the greater is the proportion of sound which reaches it by reflection from the room walls, compared with that reaching it directly from the source of sound. These reflected sounds are generally distorted, since they not only are reflected in a variable fashion with respect to frequency, but interference phenomena occur between reflected sounds coming from various reflection points. Thus, it is found that the sounds as heard from a microphone located, say, twenty feet from the source, are more distorted than those heard when the microphone is placed relatively close.

Secondly, the sounds reaching the microphone must be strong enough to give an output far exceeding the hiss due to the use of carbon, and this again necessitates fairly close placing with all performers except orchestras or large choruses.

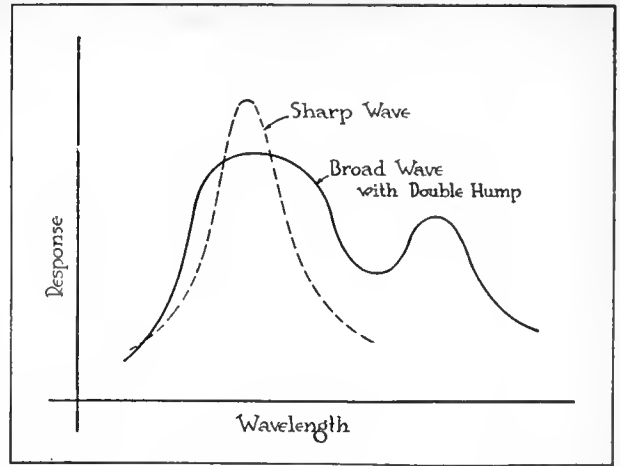

FIG. 1

It will be observed that I am not attempting to controvert Mr. Hayes's idea that the bass instruments may advantageously be moved closer to the microphone. No doubt in some studios something might be gained by work in this direction. I do not believe, however, that some of the theories on which Mr. Hayes bases his conclusion, would work out in practical broadcasting.

There is no doubt that the carbon microphone is not the final answer to the pick-up problem. What is needed is an inherently hissless and noiseless transmitter, reasonably flat from say 50 to 6000 cycles, if not better, and unsusceptible to blasting. Preferably, also, it should be a low impedance instrument, so that it can be used with a long, relatively high capacity lead. Finally, it should be capable of producing a voltage output comparable to that of a good carbon microphone, which is, incidentally, a fine amplifier in itself. Such an outfit would simplify many of our pick-up problems, and personally I pray for it night and day. If someone will invent it, I hereby offer \$25 in gold, out of my own pocket, toward a statue of the great man, to be erected at the site of his labors, be it East Pittsburgh; 463 West Street, New York; Schenectady; Van Cortlandt Park South, New York, or any other place.

Radio Lingo, Past and Present

IN THE December issue of this magazine, the writer considered the source of some of the terminology of radio. In the group of figurative expressions we considered were phantom and dummy antennas, and the counterpoise.

Numerous figurative expressions along the same lines will occur to the reader. We speak of the "fading" and "swinging" of distant signals as they vary in strength in their journey over great distances. A reactance coil is termed a "choke" for alternating currents. Interrupted continuous wave signals are sent with a "chopper." A transmitting station has a "broad" wave or a "sharp" wave; it is violating the radio regulations if it has a "double hump" or "peak." These terms are derived from the curve of response of a wavemeter or receiver to such a transmitter, as shown in Fig. 1. The word "wave" with its combinations, as used in radio, is itself in the nature of a simile, for an electric wave is some sort of displacement or stress in a figurative medium, quite inconceivable to the non-mathematical mind, and the comparison with the waves of the sea and other material wave motions is simply a convenient but rather inaccurate means of tuition.

The same hydraulic analogy persists when we

refer to wave "filters"—networks of resistance, inductance, and capacity which allow only a certain "band" of frequencies to pass. But we are also familiar with wave "traps," used to eliminate a narrow range of frequencies, and here apparently we think of the wave as a small animal—a rat or mouse—while when we speak of "carrier" waves or "carrier" telephony the wave has become a beast of burden. The term "trap," incidentally, is one of those ubiquitous comparisons which can be found in almost every trade; the bend in a drainpipe to prevent gases coming back along the tube is called a "trap" by plumbers, for example.

The "regeneration" of Armstrong is a distinctly figurative term, carrying a theological connotation, although it was used in connection with gas engines and other prime movers long before the vacuum tube was invented. There is also a physiological reference in the name "tickler" applied to a "feed-back" inductance in the plate lead of the amplifier-rectifier tube of a receiving set. The early workers in this field must have been struck by the extraordinary increase in volume as the tickler coupling was brought up, and the sudden break into oscillation; and they compared these phenomena to the peculiar spasmodic reactions of human beings to a tickling stimulus. Nor must we overlook the word "feed-back" in this connection. Why should we speak of the oscillations in the plate circuit as being "fed" back to the grid, instead of merely saying "brought" back? This figure has a practically universal utility. It is used in transportation, in reference to railroads and waterways, as, the Morris Canal Feeder. In communication, as "feeder" telegraph offices. In electrical engineering—"feeder" conductors, generating stations, etc. In sport: basketball players speak of "feeding" a team-mate when he is in position to shoot for the goal. And it is all based on the nutritional instinct, of course, and the comparison is widespread because that instinct is shared by all living creatures.

It is hardly possible to go through the list of metaphorical expressions which have invaded the radio field, but a few more typical ones may be mentioned briefly. Electricians talk of "juice," apparently a survival of the early fluid theories of electricity. The flow of high frequency oscillations on the surface of a conductor is called "skin-effect." Irregular interference of arc transmitters on low wavelengths is termed "arc-mush." Transient interference with radio reception, both natural, as from lightning, and artificial, as from arc lamps, lightning circuit grounds, sparking commutators, etc. is referred to as "strays." We talk of "shielding" a panel with metal. Spark interference is "jamming," a graphic expression

which originated in the English Channel, although familiar in a related sense to the riders in the New York City subways during the rush hours.

(To Be Continued)

## Memoirs of a Radio Engineer, VIII

IN OUR last issue I gave a brief account of the *Titanic* tragedy of 1912. For some days after the disaster all was confusion. Commercial stations and ships interfered with each other, some of the amateurs, it was charged, interfered with commercial stations, and no reliable list of survivors could be obtained. As the *Carpathia* neared New York with the survivors, communication improved, and the names came through in the rescue ship's mournful 60-cycle spark. Most of the shore copying was done, I believe, by the Wanamaker station, WHI. The amateurs shut down voluntarily, setting a good example which they have followed on other occasions since that time, although now, with commercial and amateur wavelengths so far separated, the necessity for it has disappeared as far as sos calls are concerned. They listened on their double-slide tuners and loose couplers to the long fateful strings of names. The commercial operators worked heroically, some of them standing continuous watches until they were ready to drop.

I have referred before to the anarchy which prevailed in the ether lanes in those days. Everybody transmitted on any wavelength which pleased him, or, for that matter, without knowing what his wavelength was or giving any signs that he cared. Amateurs interfered with paid commercial traffic, and refused to shut down when sworn to in code. Profanity on the air was the rule rather than the exception. The caution of Y. M. C. A. broadcasting phraseology was as yet unknown. Call letters were self-assigned, according to fancy; initials were used, or simply what was known as a "good" call—one that had a pleasing rhythm and lilt to it in the Continental or American Morse code. Both codes were used, with American Morse as yet more prevalent. The Britishers used Continental, and there was a strong prejudice against it among the Americans. Morse, with its spaced letters, such as *c* (two dots, space, dot) was harder to copy than Continental, but faster, and the Morse operators

were very contemptuous of the newer symbols. The New York *Herald*, which maintained a wireless station, OHX, in connection with its excellent shipping news department, sent press every night at 9 o'clock, first in Morse, then in Continental, but traffic was generally sent in Morse, and my recollection is that the election returns of November, 1912, were sent in Morse only. All this confusion could not last. Soon after the *Titanic* catastrophe, the government took hold. In 1910 a law had already been passed providing for radio equipment on certain steamers. This was not taken very seriously until 1912, when it was amended to apply to all vessels licensed to carry fifty or more persons on the ocean or the Great Lakes, and to provide for auxiliary apparatus covering failure of the main set, continuous watches, and penalties in case of failure to observe the law. A little later, on August 13, 1912, the Senate and House of Representatives passed "An Act to Regulate Radio Communication," under which the present licensing system for stations and operators was instituted. By an international convention signed at London on July 5, 1912, and ratified by the United States Senate early in 1913, initial call letters were allocated to the several nations. Those two years, 1912 and 1913, were the great legislative years of radio. In fact, so much legislation went through that this country has not experienced any since, and has gone twelve years without altering the radio laws themselves. What adjustments have been made the Department of Commerce has taken care of by regulations under the administrative power which it was granted by the law of August, 1912.

These momentous changes percolated down to even the lowest strata of amateurs. Some of my friends lost their call letters. Such amateur calls as MHS, NSE, DSE, SU, JR, AY and, YF, became taboo. *M* calls belonged to British stations; *D* was allocated to the Germans; *N* to the American Navy. Amateurs were to be licensed, and to receive calls beginning with numbers, denoting the radio district in which the applicant happened to find himself. All stations, from the largest down to the most insignificant which might interfere with reception over a State line (the necessary limitation of Federal authority), were subject to the new régime. It was like the lines in the Agamemnon:

None who was mighty then, and none so small  
But in the sack of doom is borne away.

All the amateurs, formerly so reckless and carefree, went about with worried faces, wondering if they could pass the examination, and trembling in fear of a new ogre, the Radio Inspector.

(To be Continued)



"THE AMATEURS . . . TREMBLED BEFORE A NEW  
OGRE—THE RADIO INSPECTOR"

# Radio Broadcast's Universal Receiver

Being the Study of Several of the Most Popular and Most Efficient Circuits for Home Construction With a View to Adapting Them to Fit Our Individual Needs

By ARTHUR H. LYNCH

**H**AVE you noticed that within the past few months the new Flexes, Dynes, and Supers described in the radio press have been extremely conspicuous by their absence? For some time, the passing of the trick circuit and its capitalization by the crafty and sometimes not too scrupulous publicist and manufacturer has been considered, by those who really understood the radio business, as a foregone conclusion. In passing on this interesting angle of the radio business, some of the older readers of RADIO BROADCAST will recall Zeh Bouck's article, entitled "The Truth About Trick Circuits" which appeared in our March, 1924, number. Some others may remember that we defended ourselves successfully in a libel suit for \$100,000 which was brought against us as a direct result of the publication of this article and our refusal to make public apology for the things we said. We hope that article was instrumental in bringing about the situation with which the radio parts business is now blessed. Certainly, it is in better shape now than it has ever been before, even though there are those who would have us believe that,

because the business in completed receivers has flourished so greatly, there is little or no parts business going on.

And before going directly to the subject at hand, perhaps a few words about the parts business will be of interest to the home constructor and others. On the magazine, we are in direct contact with thousands of the listening public by mail who express their likes and dislikes to us in no uncertain terms. Through our short wave transmitting station in our Laboratory at Garden City (2 cy) we are in direct communication with amateur radio enthusiasts in all parts of the world. Many manufacturers avail themselves of our laboratory services and from them we learn much of what is going on in their particular fields. Then, too, our laboratory has been chosen to pass on the quality of the products radio manufacturers desire to advertise in *The World's Work*, *The Atlantic Monthly*, *Harper's Magazine*, *Review of Reviews*, *Scribner's Magazine*, and *Country Life*. From these contacts, we come in still closer contact with many sides of the radio business.

There has been a considerable slackening

off of the general parts business and there is no contradicting that fact. There are far fewer varieties of parts now to be had than there were a year ago. Allah be praised for that! Much of the older kind of parts business was little more than traffic in junk. Much of the junk has now been cleared out and it will not be long before the rest will have found its way to the scrap heap. Many of the junk dealers, who, a few months ago, believed themselves to be in the radio parts business have gone broke or have gone back to their old jobs, whatever they were. The parts merchant of to-day and to-morrow is not the fellow who attempts to unload a lot of radio jimcracks on credulous but misinformed radio buyers, but he is rather the man who understands the reason for every part he sells and is able to render the home constructor the sort of service he is reasonably entitled to expect. If more dealers would study some of the existing radio circuits and determine from actual performance just which is suited to their particular needs and then have samples made, which could be displayed in their stores and operated if need be, they would

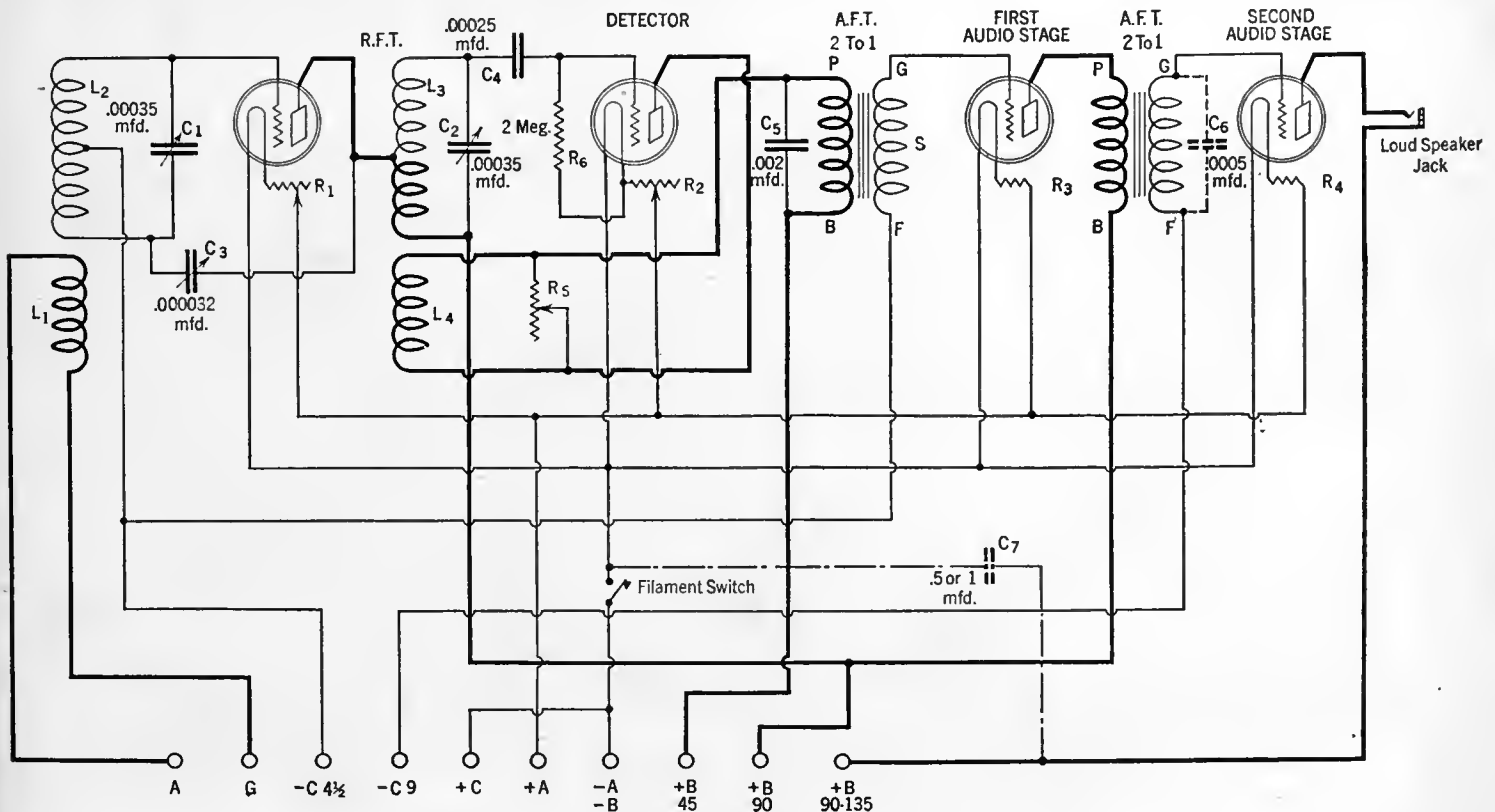

FIG. 1

This is the circuit diagram of the Universal Receiver. It consists of one stage of tuned radio-frequency amplification utilizing the Rice method of neutralization, a regenerative detector, and two low ratio stages of audio-frequency amplification. The wiring of the assembled receiver takes the same form followed in this diagram. For instance, the lower terminal of the radio frequency coupling unit is the lower end of L<sub>4</sub> in the diagram

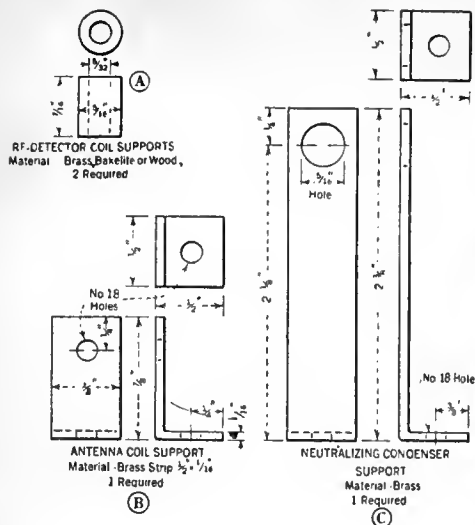

FIG. 2

The dimensions and other specifications for the angles and other hardware used to assemble the receiver are given here. In the case of the bushings, bakelite or wood will do as a substitute for brass

find a harvest in the parts business far beyond their most optimistic expectations. In fact, those dealers who are following this plan, and there are a great many of them, are finding the parts business to be anything but dead.

Every home constructor is actually a

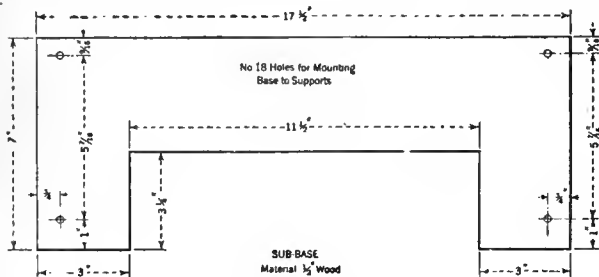

FIG. 3

The baseboard layout. Especial care should be exercised in cutting out the section to be removed so as to prevent splitting the wood. The use of this type of baseboard insures easy assembly and wiring

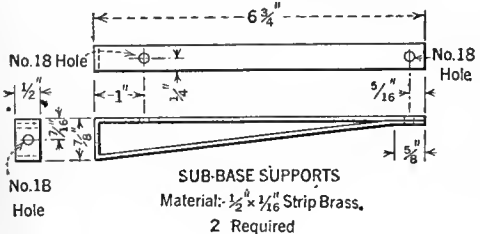

FIG. 4

Two brackets, made as shown here, support the baseboard assembly. Approximately 32 inches of  $\frac{1}{2} \times \frac{1}{16}$ -inch strip brass are required to make the two brackets

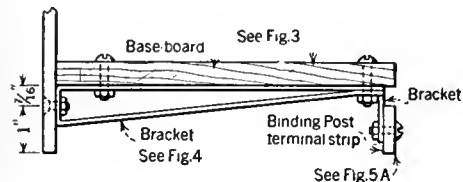
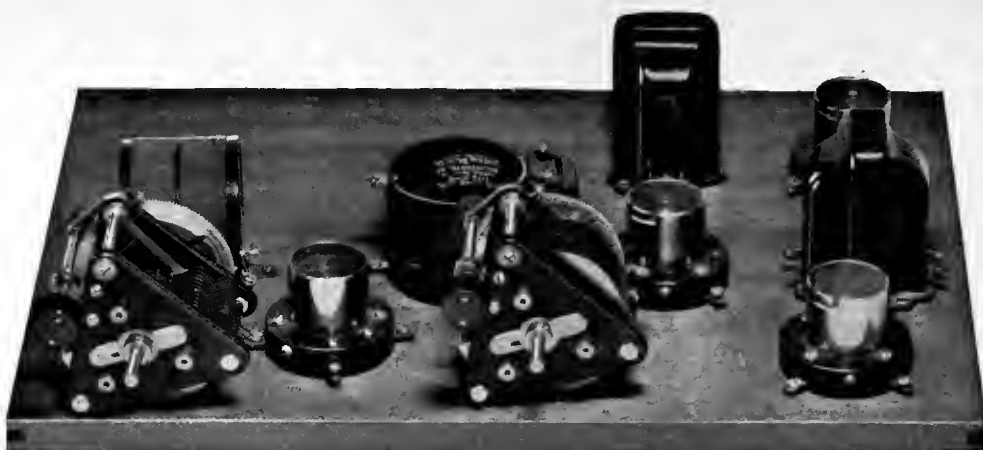

FIG. 4A

The baseboard is mounted on the brackets and panel in the manner shown above. Two brackets for the terminal strip are required. The vertical part is  $1\frac{1}{4}$  inches long and the hole for the strip is located  $\frac{1}{4}$  of an inch from the bottom



HOW THE SET STARTED . . .

The embryo "Universal." By laying out the parts on the base-board, it was possible to experiment with changes in location of the various coil and condenser units to observe any improvement in results obtained. This system of experimental construction is to be highly recommended

radio salesman in his neighborhood. If his receiver works well, and homemade receivers usually do, the builder generally proclaims from the housetops, first the wonders of his outfit and then the wonders of radio in general. Many of his auditors wouldn't give a red apple to duplicate his accomplishment, but many of them would like to be able to hear the things he hears and the rapid growth of the radio business to-day may well be credited to the home constructor.

THE PROBLEM

ALL of the foregoing was brought to mind by a moment's consideration of the problem at hand and our reasons for dealing with the subject of the universal receiver. First of all it was necessary for us to determine on a particular circuit. It is almost impossible to think of circuits at all without thinking of all the dynes and whosits and so forth which were given so much free space in the newspapers a few short months ago. Most of them have met a natural death. There remain but a few

tried and true circuits, so the matter of selecting the proper one for our individual use, is not such a difficult job, even for the uninitiated. There are many we could attack and use to good advantage, but when all the smoke has cleared away and the shouting is all over and we get back to a peace time basis, there is but one real type of circuit which may be called universal and that is the combination of one stage of tuned, neutralized radio frequency amplification, a regenerative detector and some kind of audio-frequency amplifier which will produce good quality. To explain the kind of a circuit we are describing, each time we have some variation of this circuit to contend with is indeed embarrassing and the name "Universal" is about as near the correct characterization as we have been able to find.

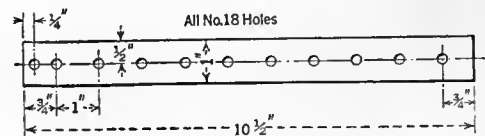

FIG. 5A

This is the layout for the binding post terminal strip. Bakelite, hard rubber, or formica  $\frac{1}{8}$ -inch thick is satisfactory for use here

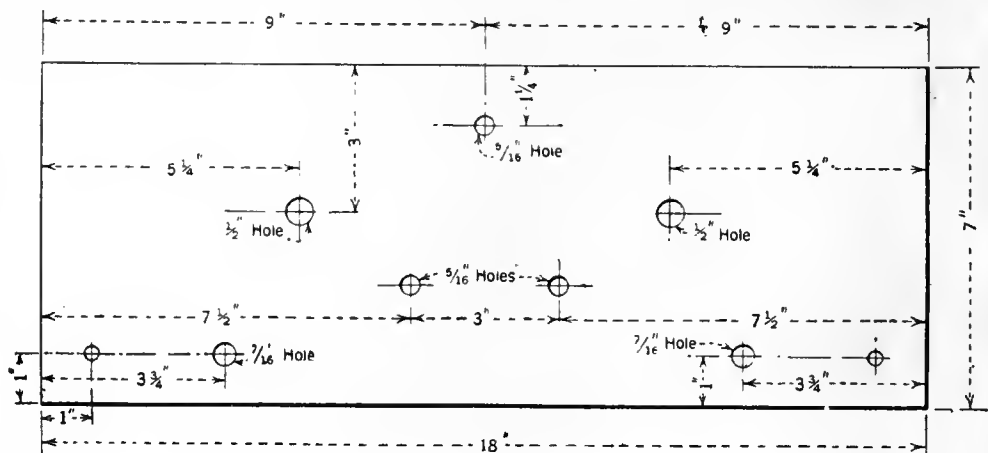

FIG. 5

The panel layout. Only center holes are shown so as to enable the builder to use parts that he may have on hand which differ in make from those recommended. In any case, before these center holes are drilled it is well to spot off the other mounting holes

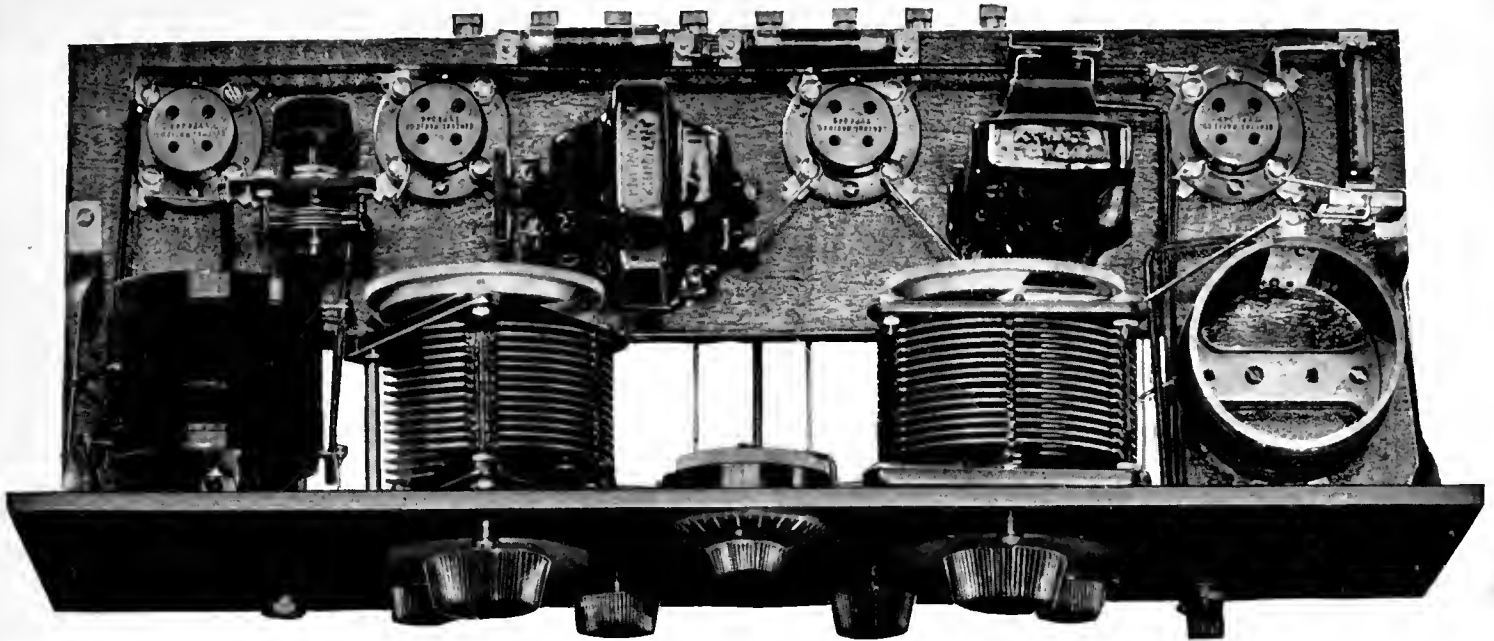

FIG. 7

Here is a view of the Universal employing the new UX sockets. With this arrangement there is a generous spacing of the parts and it is possible to employ any of the UX type of tubes such as the UX-199, UX-201A, WX-12, or UX-112 tubes in these sockets. The advantage of building the receiver with these sockets is apparent as there is not the necessity for using adapters when other voltage tubes are to be employed. Leads are short and direct. another obvious advantage

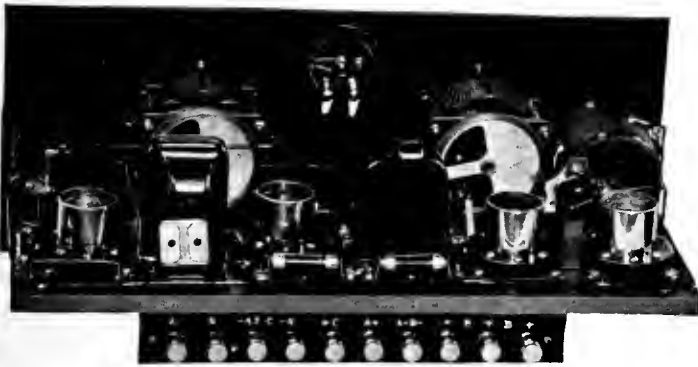

FIG. 6

This is a picture of the Universal receiver employing, in the main, General Radio Company parts. Standard UV type sockets are provided. This allows the use of either the UX or UV 201A type of tube in this set. Note the position of the neutralizing condenser between the first two sockets at the right. The grid leak and Amperite mountings are easily accessible if replacement ever becomes necessary. The binding post terminal strip serves also as a support for the rear of the wooden sub-base

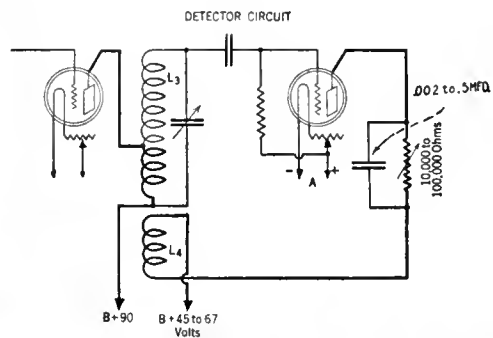

FIG. 9

Still another highly efficient way in which to control regeneration by a variable resistance. It is necessary to experiment with different values of capacity shunted across the resistance to obtain smooth control of regeneration. Such resistance units as the Bradleyohm No. 10, the Centralab, and the Royalty may be employed successfully

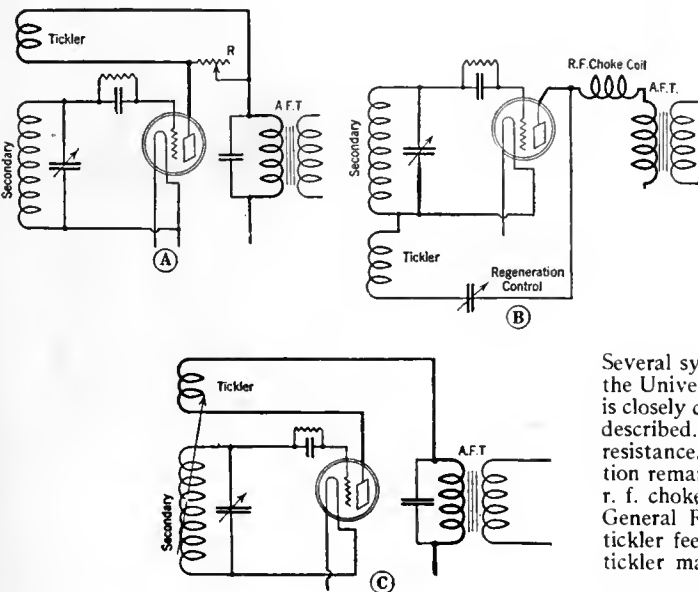

FIG. 8

Several systems of regeneration which may be incorporated in the circuit of the Universal receiver. In A, the resistance R shunts the tickler coil which is closely coupled to the secondary. This system is employed in the receiver described. Regeneration is obtained and then controlled by varying the resistance. In B, a condenser feedback system is employed which will function remarkably well when care is taken to include in the circuit a suitable r. f. choke-coil. In C is shown the usual tickler feedback system. When General Radio coils are used in the receiver and it is desired to employ tickler feedback, a mechanical arrangement must be provided so that the tickler may be coupled to the secondary of the detector coil unit. This puts another control on the panel

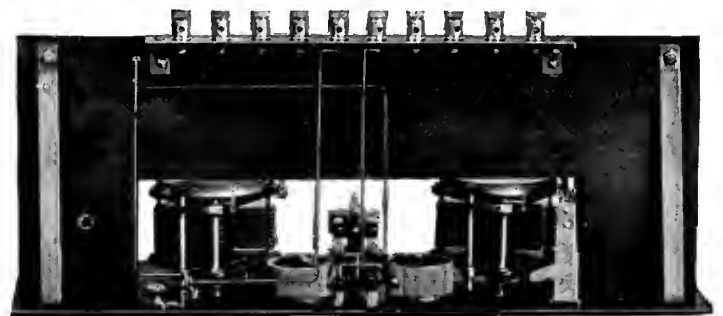

FIG. 10

With the use of the cut-out baseboard, the wiring and assembly of the parts employed in the construction of the receiver is made amazingly simple. Unlike a bakelite sub-base it is possible to screw down on to the wood the sockets, transformers, and other material without previously drilling it to admit the screws

A circuit which would perform satisfactorily in city and country on dry cells or with a storage battery, without wasting B batteries, which would give more than ordinarily good quality of reproduction on a loud speaker over comparatively long distances, which was easy to build and easy to operate after it was built, and, last, but not least a circuit for which the parts could be procured in any town of any size in any part of the world; that was our notion of what the "Universal" should be. We believe we have found it. It is not a new circuit, by any manner of means. Fundamentally it was used in slightly modified forms in such popular receivers as the Teledyne, the Browning Drake, The Roberts, RADIO BROADCAST'S Four-Tube, Three-Tube, and Two-Tube Knockout Receivers. Hammarlund-Roberts, RADIO BROADCAST'S Aristocrat, the Samson T. C. Receiver and the Silver Knockout. But since the appearance of most of these receivers in RADIO BROADCAST, improvements have been made in the design of many of the integral parts and this improvement is particularly evident in the matter of tubes.

In order to show how various parts may be used in this circuit with satisfaction, we are illustrating with this article, a receiver employing just about the same circuit and sold in kit form by the Samson Company of Cambridge, Massachusetts, and another built to our design by the American Mechanical Laboratories of Brooklyn, New York. Other variations on the same theme may be seen by looking over the article by Allan T. Hanscom in our October, 1925, number and the descrip-

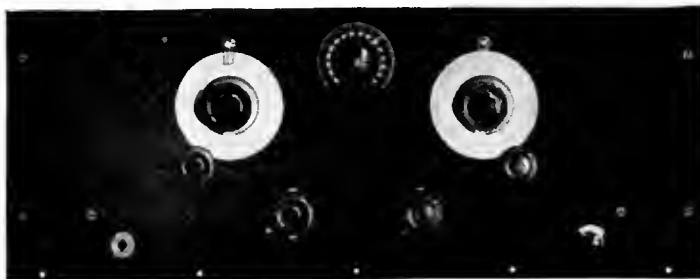

FIG. 11

A panel view of the Universal. Symmetrical layout has been one of the prime considerations in the construction of this receiver.

tion of RADIO BROADCAST'S "Aristocrat," by the present writer, in our November number. We are very anxious to have the fact understood that intelligent substitution of parts for those we have used will not detract from the performance of the receiver. It is impossible for us to list all those which can be used, but we wish to show no favoritism in the matter of recommending parts for the RADIO BROADCAST Universal Receiver.

So, then, as an example of what may be done, let us first consider the circuit and then the components of a single manufacturer which may be used to advantage in it. From a study of Fig. 1 it will be seen that there are two coil assemblies, one, a primary and secondary in the antenna circuit ( $L_1$  and  $L_2$ ; the latter tuned by the variable condenser  $C_1$ ) the other, a tuned radio-frequency transformer of the auto transformer type and a tickler coil, which is fixed in position but adjusted electrically by means of the 500- to 50,000-ohm resistance,  $R_5$  shunted across it. These coils are indicated in the diagram by  $L_3$  and  $L_4$ . By properly using the windings already provided on the General Radio Company's

coils, No. 277D, both these coil units are instantly provided. No changes whatever need be made as the coils are of solenoid type with two windings on a single form. Two such forms are necessary. On each form there is a small and a large winding. The small ones are used for  $L_1$  and  $L_4$ , while the large ones are used for  $L_2$  and  $L_3$ . The tap indicated on  $L_3$  is easily provided by picking up a turn of the large coil, and scraping clean. It is merely necessary to solder the proper wire

to it to carry out the correct circuit arrangement. In  $L_3$  this tap is made 39 turns from the grid end and the tap on  $L_2$  is made in the exact center of the coil. These coils may be used with .00035 mfd. variable condensers to cover the broadcast frequency range and the results obtained in our laboratory tests of the completed receiver indicate that they will go well below the lowest and well above the highest frequencies transmitted by the broadcasting stations now on the air. Let us now consider the remainder of the parts used for storage battery operation and once having done that we will study the few changes necessary for using the same circuit arrangement with dry cell tubes.

#### PARTS USED IN R. B. LAB MODEL OF THE UNIVERSAL RECEIVER

THE parts employed are: 1 Panel, 7 x 18, 1 Wood sub-base 7 x 17½, cut as shown in Fig. 3 and for simplicity of mounting and wiring we recommend the use of wood not more than ½ inch thick, 2 sub-base supports, made as shown in Fig. 4, from ½ x ¼ inch brass strip (the approximate length of this strip required for the re-

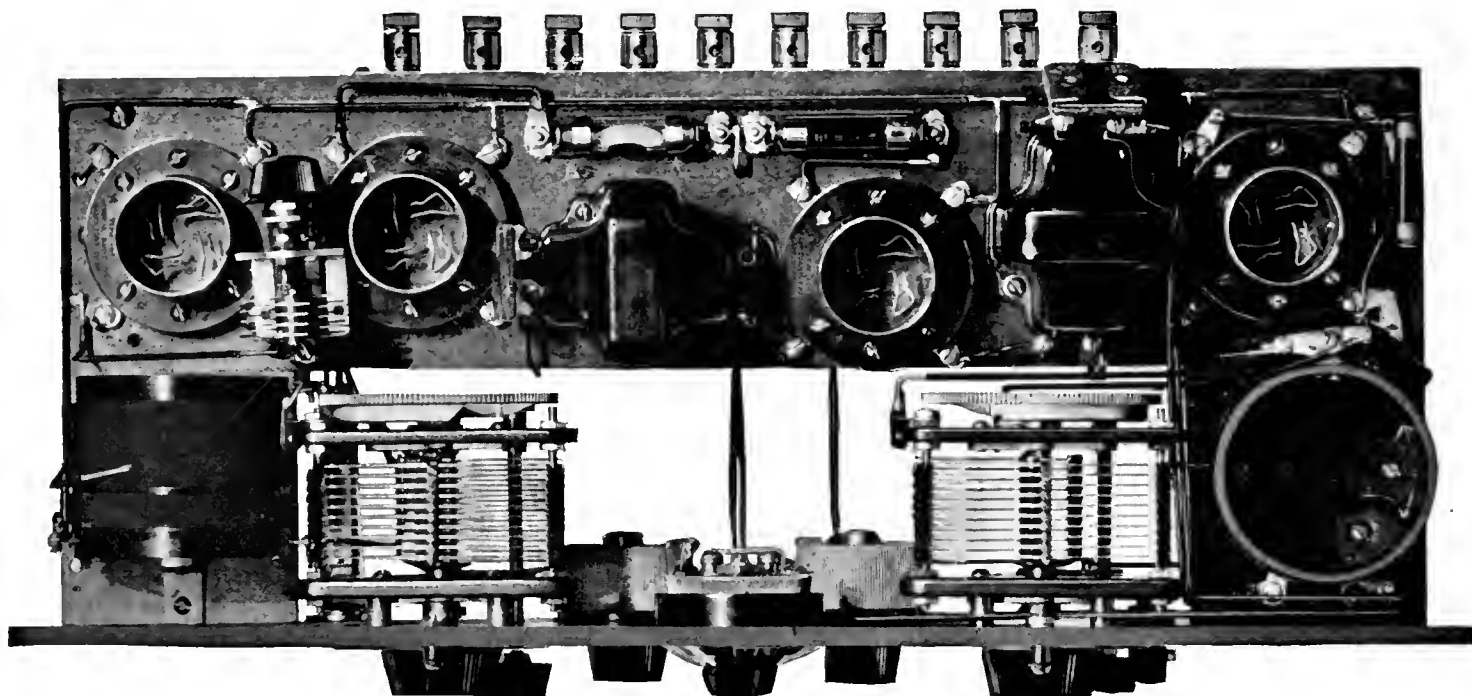

FIG. 12

A base view of the receiver. Note that the coil units are in line with and at right angles to each other. This is absolutely necessary for obtaining proper neutralization

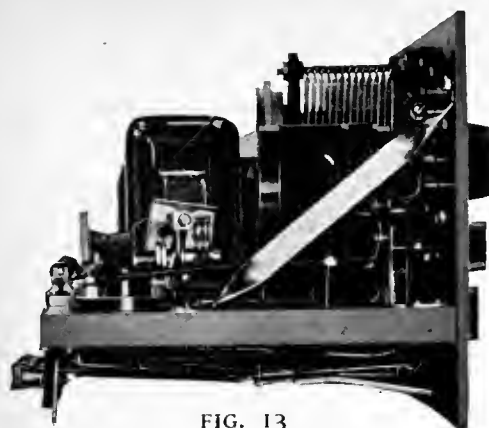

FIG. 13

In this end view the use of other brackets is shown. The builder may use either type according to his own desires

ceiver is 32 inches); 2 Detector coil supports, as illustrated in Fig. 2A; 1 Antenna coil support, as shown in Fig. 2B; 1 Neutralizing condenser support, as shown in Fig. 2C; 1 Royalty, 500- to 50,000-ohm variable resistor; 1 each Electrad, .00025-.002- and .0005-mfd. fixed condensers, and the following General Radio parts: 2 coils, type 277D; 2 variable condensers with vernier attachment, .00035 mfd. capacity, either S.L.W. or S.L.C., type 247P; 2 Dials type 310; 1 neutralizing condenser, type 368; 2 audio-frequency transformers, 2:1 ratio, type 285L; 4 sockets, type 156 for use with tubes having UV base, or type 349 UX sockets for tubes with UX bases, as explained further along; 1 binding post strip, with 8 posts, type 138Z; 2 rheostats, 10 ohms, type 301; 1 Yaxley filament switch and phone jack and one Electrad grid leak resistor, 2 megohm; and the large  $\frac{1}{2}$  to 1 mfd. condenser across the B batteries is optional, but advisable. One each  $\frac{1}{4}$  and  $\frac{1}{2}$  ampere Brach or Amperite filament ballasts and mountings.

BEFORE BUILDING THE RECEIVER

TO BEGIN with, the combination which we have found to meet nearly every occasion, except where the storage battery is impossible for one reason or another, is the circuit in which 201-A type tubes are used in all sockets except the output of the amplifier and here we have found the UX-112 very satisfactory, when operated with 135 volts on the plate and a negative bias of approximately minus 9, as shown in the diagram, Fig. 1 With this arrangement, using the proper plate and biasing voltage (B and C) on the radio frequency tube as indicated in the same diagram the plate current consumption is in the neighborhood of five milliampères and should not be above seven. The UX-112 will increase this figure somewhat. This sum is very low for a receiver of this general type and is one of the outstanding features of the RADIO BROADCAST Universal. If your receiver is to be located more than fifty miles from a broadcasting station, you may find that one low and one high ratio transformer will give you more

volume and in such cases it is advisable to use it. It should not be more than 6:1, however. If this combination of transformers is to be used, be sure the high ratio transformer is used last and *not first* as is common practise. The reason for this change is well covered by Mr. Keith Henney, Director of RADIO BROADCAST'S Laboratory, in his article, *Tubes: Their Uses and Abuses*, in our last number.

The matter of sockets is a rather important one, in view of the great number of tubes already on the market and those which will probably follow. We have found that the standard socket is just about as satisfactory at the present time as any, because the standard tubes will fit in them and so will the tubes with the new UX bases. Where either the WD-11 or the UV-199 types of tube are to be used, they may be placed in the standard sockets by means of adapters. So much, for the receiver when the tubes to be used are those with which we have become quite familiar.

Now for the dry cell operation. We have found the combination of three 199 and one 120 tubes, or their equivalent, to be very satisfactory and, if you contemplate the building of this receiver without using any of your present stock, we suggest that you use the new type of socket because it may be used with any of the new tubes and it will be remembered that both these tubes are soon to be on the general market with the new UX bases, and by using the UX sockets, it will be possible to convert your receiver from dry battery operation to one which may be used with a storage battery by going to no greater bother than changing the tubes. Many of the independent tubes have been found to be very satisfactory and most of them will be on the market within a short time, probably

before this article gets into circulation, with the new type bases. In order that you may have a direct comparison of the two types, we illustrate in Figs. 6 and 7, just how they will look when completed. The proper use of any type of tube in any receiver is one of the greatest factors in determining its performance and we can not urge too strongly the careful reading and then putting into application the instruction sheets which accompany the tubes now on the market.

BUILDING THE RECEIVER

AFTER procuring all the necessary parts and properly bending and drilling all the brass fittings and the wood sub-base, the drilling of the panel can be undertaken and the layout shown in Fig. 5

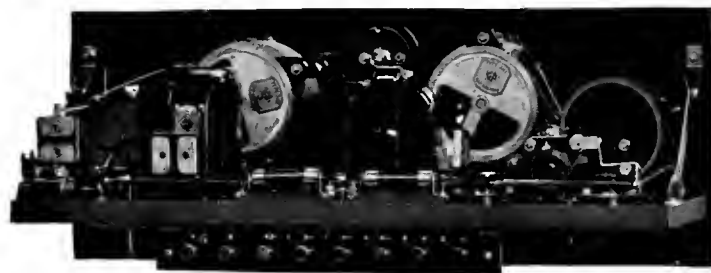

FIG. 14

This view of the rear of the Universal gives a pretty good idea of the disposition of the various parts. In this particular receiver, larger tuning condensers have replaced the .00035 mfd. variables. However, for the broadcast range the .00035's are entirely satisfactory

will be found helpful in this connection. Next, all the parts which are to be directly attached to the panel should be put in place as should those which are to be attached to the sub-base. From this point on, the work of assembly is a very simple matter and it is but necessary to fasten the sub-base and the panel together by means of the brass supports and attach the binding post strip, which acts as the rear support for the receiver and then go ahead with the wiring. The dimensions of the entire assembly are such that the completed receiver will fit into a standard 7 x 18-inch cabinet and the use of a cable lead to the batteries is handy and is

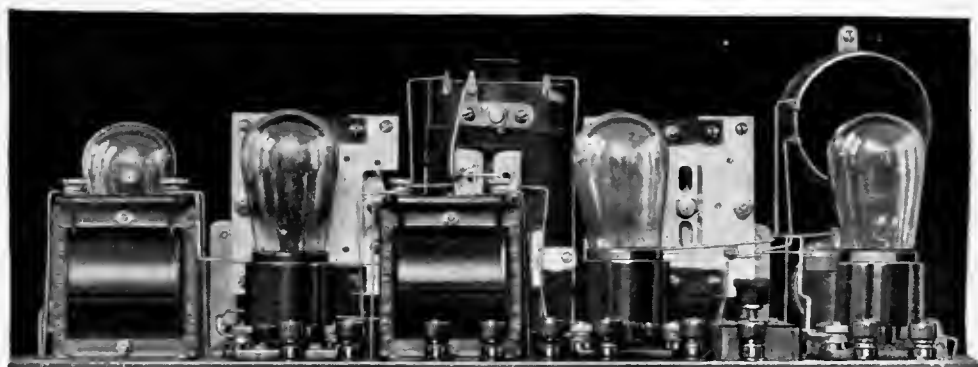

FIG. 15

So much equipment in such small space is, in itself, an accomplishment. This layout of the Samson TC Receiver is a little difficult to approximate but when you have it finished it's a real receiver. The tests run on it in our laboratory revealed it as one of the best receivers we have ever used. It is compact, easy to handle, economical to use and the tone quality is far above the average. On the second stage audio it performs very well with a cone speaker which is saying much for a transformer-coupled audio receiver

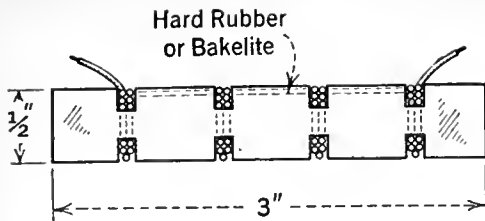

FIG. 16

To keep radio frequency currents where they are useful, a choke coil is shown in use in Fig. 8B. Such a coil is illustrated above and may consist of No. 30 wire wound 100 turns to the slot. With such a coil the feed-back condenser may be a small "midget" condenser

recommended. Furthermore, the dimensions on the sub-base are large enough to allow the use of any sockets or transformers now on the market, without making necessary any changes in design.

Perhaps there are those who would like to improve on the general design of this receiver in one way or another and the point which might well be expected to be attacked is the control of regeneration by the resistance across the tickler. Some of the attempts at this which were made in our laboratory, during the development of this receiver are indicated in Fig. 8, but for a number of reasons we have found the system finally employed here to be most practicable with the type of coils employed. Since the inductive relation of the tickler to the secondary of the radio-frequency transformer, that is coil  $L_4$  to coil  $L_3$ , is always the same there is no change in wavelength or detuning in the radio frequency circuit, which is sometimes noticeable to a marked degree in receivers where a tickler of the rotary type is employed. Then, too, the number of moving wires and the breaking of connections they sometimes cause has been eliminated and with the proper detector plate voltage and the proper

variable resistance, the control of regeneration is remarkably smooth, which is a distinct advantage.

## CONDENSER FEED BACK

A VARIATION of the resistance control is the condenser feedback, probably due to Weagant and used commonly in the Reinartz circuit. A fixed coil is placed near the detector secondary and coupling to the plate is effected by means of a series condenser. The condenser and coil is then a shunt path for the radio frequency currents, and a choke coil may be necessary to keep these currents from escaping through the phones or amplifier primary. The circuit is shown in Fig. 8B and a drawing of a choke in Fig. 16. There should be no condenser across the output in this arrangement. This method of adding regeneration is particularly smooth in operation, and it avoids the movable tickler with its varying field.

And now there is little to do but the soldering and wiring. Wherever possible, the home constructor should fit himself out with a good soldering outfit, and a set of those small wrenches which comes in so handy in getting the nuts on and off transformers, tube sockets and such places. He should have a good supply of bus bar and spaghetti or flexible rubber-covered wire and a goodly supply of small sized lugs which may be directly fastened to the various units which go to make up the circuit and to which the soldering is actually done, rather than to the units themselves. By using this method of construction, it is possible at any later time to remove the holding nuts and off comes the wire with no fuss whatever. Then it should also be remembered that a good small screw driver is valuable in placing the soldering lugs under the heads of the screws in those units provided with screws instead

of binding posts, and there are a great many of them on the market. That's about all there is to the building, and now we come to the point of putting our prize on the air.

## OPERATING THE UNIVERSAL

THE antenna used with RADIO BROADCAST's Universal Receiver should be about 150 feet long, from the receiver itself to the outside insulator, including the length of the lead-in wire. With such an antenna, if you are located within 25 miles of a powerful broadcasting station you may find that the receiver is not selective enough to permit you to cut out the local station and bring in distant stations on frequencies near that of the local. This objection may be overcome by inserting a .0001-mfd. fixed condenser in series with the antenna or by reducing the length of the antenna a little. The former method is easier and usually more effective.

It will be found that the two dials will run just about even over the entire scale, if they are properly set when they are attached to the shafts. If the wiring is correct the receiver should respond as soon as it is put on the air, if there is any broadcasting going on. The only adjustment other than that which usually characterizes tuning is the setting of the neutralizing condenser and that is a simple matter, which once taken care of need cause no further worry. In order to set the neutralizing condenser properly, some broadcaster whose frequency is about 1000 kc. (300 meters) and whose volume is not very great should be tuned-in with the detector oscillating. The detector condenser should be tuned until the whistle from the station is quite loud. Then the first, or antenna, condenser, should be tuned. It will be noted that the whistle will change in pitch as this condenser is varied. When the set is exactly neutralized, this whistle will not change, and the problem is to adjust the neutralizing condenser until such a state of affairs exists. The neutralizing condenser should be varied a little at a time, each time noting the change in pitch of the whistle. On one side of the neutralization point, the pitch will rise in frequency; when the neutralizing point has been passed, the pitch will lower in frequency. By listening for these changes in pitch, the listener can tell on which side of the actual balance point he is.

The usual method of turning out the first tube and adjusting the neutralizing condenser until no sound is heard is not satisfactory. The grid-plate capacity of tubes differs by a large factor in the two conditions of tube unlighted and tube lighted. In other words, the tube will not be neutralized when it is lit if it is balanced with the filament turned out. It should be neutralized under actual operating conditions.

A more practical all-round receiver than RADIO BROADCAST's Universal will be hard to find.

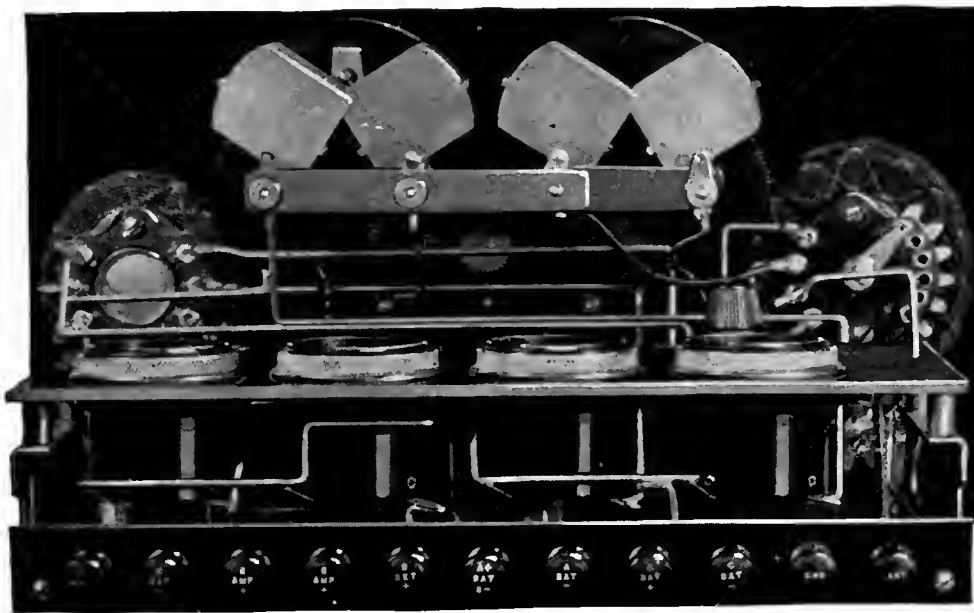

FIG. 17

A typical example of the Universal circuit worked into the small dimensions of RADIO BROADCAST's Phonograph Receiver. A Hanscom single-control unit with model 2 RK Clarotuner coils provides the tuning system, and the sub panel with special sockets was supplied by Osborne & Company of Boston to our dimensions. Note the freedom from visible wiring



MILES FROM TO →										
	BOSTON	CHICAGO	CINCINNATI	CLEVELAND	DETROIT	NEW YORK	PHILADEL- PHIA	PITTS- BURGH	ST. LOUIS	
Atlanta, Ga.	930	590	375	550	595	745	660	520	470	
Baltimore, Md.	350	600	420	315	405	170	85	200	730	
Birmingham, Ala.	1050	580	415	615	640	855	775	610	400	
Buffalo, N. Y.	400	450	395	175	215	295	280	180	655	
Calgary, Alta.	2060	1370	1620	1645	1555	2000	1200	1755	1950	
Dallas, Tex.	1515	800	795	1000	990	1350	1280	1060	540	
Davenport, Ia.	990	160	360	455	390	860	800	560	200	
Denver, Colo.	1750	900	1080	1200	1140	1600	1550	1310	775	
Des Moines, Ia.	1135	300	500	605	540	1010	965	710	265	
Elgin, Ill.	870	35	280	335	260	740	690	440	255	
Galveston, Tex.	1585	945	880	1100	1090	1400	1315	1125	690	
Hastings, Neb.	1400	560	740	865	795	1265	1215	965	445	
Havana, Cuba.	1500	1315	1100	1250	1325	1300	1270	1215	1165	
Houston, Tex.	1575	925	875	1085	1080	1400	1310	1120	660	
Indianapolis, Ind.	790	160	100	255	230	630	575	325	230	
Iowa City, Ia.	1045	200	405	505	435	900	860	600	210	
Joliet, Ill.	870	35	250	330	260	730	680	430	225	
Kansas City, Mo.	1225	400	545	690	640	1080	1025	775	230	
Lancaster, Pa.	310	600	430	295	390	130	65	200	750	
Lansing, Mich.	680	170	240	170	85	550	520	280	400	
Lincoln, Neb.	1320	465	650	775	700	1175	1120	875	365	
Los Angeles, Cal.	2560	1730	1875	2020	1950	2420	2360	2110	1565	
Louisville, Ky.	815	270	90	300	310	645	570	345	245	
Madison, Wis.	925	120	370	405	325	800	760	520	300	
Memphis, Tenn.	1120	480	410	620	615	950	870	655	240	
Mexico City, Mex.	2300	1675	1600	1800	2120	2115	2035	1860	1420	
Miami, Fla.	1280	1180	950	1085	1150	1100	1025	1010	1050	
Milwaukee, Wis.	840	80	320	335	255	725	690	450	325	
Minneapolis, Minn.	1110	360	590	620	545	1005	980	750	465	
Montreal, P. Q.	260	740	700	490	515	335	400	470	970	
Oakland, Cal.	2650	1820	2000	2115	2030	2500	2490	2240	1705	
Ottawa, Ont.	315	640	620	410	425	335	380	410	875	
Providence, R. I.	40	825	700	525	585	150	235	450	1000	
Rochester, N. Y.	340	500	450	240	280	250	260	225	720	
Salt Lake City, Utah.	2070	1245	1440	1550	1475	1950	1900	1650	1145	
San Francisco, Cal.	2650	1820	2020	2140	2065	2540	2500	2240	1715	
Schenectady, N. Y.	145	700	600	400	460	150	210	350	900	
Scranton, Pa.	240	615	490	315	390	100	105	230	790	
Seattle, Wash.	2500	1710	1950	2000	1920	2400	2385	2115	1695	
Shenandoah, Ia.	1240	400	590	700	635	1110	1050	800	310	
Springfield, Mass.	80	760	645	460	525	120	200	395	960	
Tampa, Fla.	1160	1060	775	925	985	1000	930	870	855	
Toronto, Ont.	440	425	400	190	200	350	340	225	640	
Valparaiso, Ind.	815	45	200	270	210	670	625	370	255	
Vancouver, B. C.	2500	1760	2000	2040	1950	2400	2385	2150	1750	
Washington, D. C.	390	590	400	300	390	200	125	190	705	
Winnipeg, Man.	1350	710	970	940	850	1295	1275	1050	845	
Worcester, Mass.	40	800	700	500	570	155	235	435	985	
Zion, Ill.	850	45	285	320	240	720	675	420	290	

Sixteen

# RADIO BROADCAST'S

## Booklet of American and Canadian Broadcasters

December 15, 1925

CALL SIGNAL	LOCATION	FREQUENCY IN KCYS.	WAVE-LENGTH IN METERS	POWER IN WATTS
WSAI	Mason, Ohio	920	325.9	5000
WSAJ	Grove City, Pa.	1310	229	250
WSAN	Allentown, Pa.	1310	229	100
WSAR	Fall River, Mass.	1180	254	100
WSAU	Chesham, N. H.	Ceased activities October, 1925		
WSAV	Houston, Tex.	1210	248	100
WSAX	Chicago, Ill.	Ceased activities June, 1925		
WSAZ	Pomeroy, Ohio	1230	244	50
WSB	Atlanta, Ga.	700	428.3	1000
WSBC	Chicago, Ill.	1430	209.7	500
WSBF	St. Louis, Mo.	1100	273	250
WSBT	South Bend, Ind.	1090	275	250
WSDA	New York, N. Y. (Shortly to re-open)	1140	263	250
WSKC	Bay City, Mich.	1150	261	100
WSM	Nashville, Tenn.	1060	282.8	1000
WSMB	New Orleans, La.	940	319	500
WSMH	Owosso, Mich.	1250	240	10
WSMK	Dayton, Ohio.	1090	275	500
WSOE	Milwaukee, Wis.	1220	246	500
WSRF	Broadlands, Ill.	1290	233	10
WSRO	Hamilton, Ohio	1190	252	100
WSUI	Iowa City, Ia.	620	483.6	500
WSY	Auburn, Ala.	1200	250	500
WTAB	Fall River, Mass.	1130	266	10
WTAC	Johnstown, Pa.	1120	268	100
WTAD	Carthage, Ill.	1270	236	50
WTAF	New Orleans, La.	Call signal changed to <b>WOWL</b>		
WTAG	Worcester, Mass.	1120	268	500
WTAL	Toledo, Ohio	1190	252	10
WTAM	Cleveland, Ohio	770	389.4	2500
WTAP	Cambridge, Ill.	1240	242	50
WTAQ	Osseo, Wis.	1180	254	100
WTAR	Norfolk, Va.	1150	261	100
WTAS	Elgin, Ill.	Call signal changed to <b>WLIB</b>		
WTAT	Boston, Mass. (portable)	1230	244	100
WTAW	College Station, Tex.	1110	270	250
WTAX	Streator, Ill.	1300	231	50
WTAY	Oak Park, Ill.	Call signal changed to <b>WGES</b>		
WTG	Lambertville, N. J.	1150	261	15
WTG	Manhattan, Kan.	1100	273	50
WTHS	Flint, Mich.	Ceased activities October, 1925		
WTIC	Hartford, Conn.	860	348.6	500
WWAD	Philadelphia, Pa.	1200	250	100
WWAE	Plainfield, Ill.	1240	242	500
WWAO	Houghton, Mich.	1140	263	250
WWGL	Richmond Hill, N. Y.	1410	212.6	500
WWI	Dearborn, Mich.	1130	266	500
WWJ	Detroit, Mich.	850	352.7	1000
WWL	New Orleans, La.	1090	275	100

To make these pages into a booklet, cut through the center, horizontally along the rule, and along the outside of the page. It will then be easy to fit the pages in order, as numbered. They may be bound with a pin or sewed with several stitches.

Fourteen

CALL SIGNAL	LOCATION	FREQUENCY IN KCYS.	WAVE-LENGTH IN METERS	POWER IN WATTS
KFJB	Marshalltown, Ia.	1210	248	10
KFJC	Junction City, Kans.	1370	218.8	10
KFJD	Oklahoma, Okla.	1150	261	225
KFJE	Astoria, Ore.	1220	246	10
KFJF	Grand Forks, N. Dak.	1080	278	100
KFJM	Portland, Ore.	1200	250	10
KFJN	Cedar Falls, Ia.	1160	258	50
KFJX	Fort Dodge, Ia.	1220	246	50
KFJZ	Fort Worth, Tex.	1180	254	50
KFKA	Greeley, Colo.	1100	273	50
KFKB	Milford, Kans.	Ceased Activities June, 1925		
KFKC	Conway, Ark.	1200	250	100
KFKD	Lawrence, Kans.	1090	275	500
KFKE	Hastings, Neb.	1040	288.3	2000
KFKF	Kirksville, Mo.	1330	226	5
KFLB	Menominee, Mich.	Ceased activities June, 1925		
KFLP	Cedar Rapids, Ia.	1170	256	20
KFLR	Albuquerque, N. Mex.	1180	254	200
KFLU	San Benito, Tex.	1270	236	10
KFLV	Rockford, Ill.	1310	229	100
KFLX	Galveston, Tex.	1250	240	10
KFLZ	Atlantic, Ia.	1100	273	100
KFMB	Little Rock, Ark.	Changes pending		
KFMQ	Fayetteville, Ark.	1000	299.8	500
KFMR	Sioux City, Ia.	1150	261	100
KFMT	Minneapolis, Minn.	Call signal changed to <b>WHAT</b>		
KFMW	Houghton, Mich.	1140	263	50
KFMX	Northfield, Minn.	890	336.9	750
KFNF	Shenandoah, Ia.	1130	266	500
KFNG	Coldwater, Miss.	1180	254	10
KFNI	Warrensburg, Mo.	Ceased activities June, 1925		
KFNL	Paso Robles, Cal.	Ceased activities June, 1925		
KFNV	Santa Rosa, Cal.	1310	229	50
KFNY	Helena, Mont.	Ceased activities June, 1925		
KFOA	Seattle, Wash.	660	454.3	500
KFOB	Burlingame, Cal.	1330	226	500
KFOC	Whittier, Cal.	Changes pending		
KFOJ	Moberly, Mo.	1240	242	10
KFON	Long Beach, Cal.	1290	233	100
KFOO	Salt Lake City, Utah	1270	236	250
KFOP	David City, Neb.	1330	226	100
KFOT	Wichita, Kans.	1300	231	50
KFOX	Omaha, Neb.	1210	248	100
KFOY	St. Paul, Minn.	1190	252	50
KFPD	Los Angeles, Calif.	1260	238	500
KFPL	Dublin, Texas	1190	252	15
KFPM	Greenville, Tex.	1240	242	10
KFPP	Los Angeles, Cal.	1300	231	500
KFPV	San Francisco, Cal.	Changes pending		
KFPW	Cartersville, Mo.	1160	258	20
KFPY	Spokane, Wash.	1130	266	100
KFQA	St. Louis, Mo.	1150	261	100
KFQB	Fort Worth, Texas	1140	263	150

Three

CALL SIGNAL	LOCATION	FREQUENCY IN KCYS.	WAVE-LENGTH IN METERS	POWER IN WATTS
KDKA	East Pittsburgh, Pa.	970	309.1	10,000
KDLR	Devils Lake, N. Dak.	1300	231	5
KDPM	Cleveland, Ohio	1200	250	500
KDYL	Salt Lake City, Utah	1220	246	50
KDZB	Bakersfield, Cal.	1430	209.7	100
KFAB	Lincoln, Neb.	800	340	500
KFAD	Phoenix, Ariz.	1100	273	100
KFAE	Pullman, Wash.	860	348.6	500
KFAF	San Jose, Cal.	1380	217.3	50
KFAJ	Boulder, Colo.	1150	261	100
KFAN	Moscow, Idaho	Ceased Activities October, 1925		
KFAU	Boise, Idaho	1060	282.8	750
KFAW	Santa Ana, Cal.	1400	214.2	10
KFBB	Havre, Mont.	1090	275	50
KFBC	San Diego, Cal.	1340	224	10
KFBG	Tacoma, Wash.	1200	250	50
KFBK	Sacramento, Cal.	1210	248	100
KFBL	Everett, Wash.	1340	224	50
KFBS	Trinidad, Colo.	1260	238	15
KFBU	Laramie, Wyo.	1110	270	500
KFCB	Phoenix, Ariz.	1260	238	100
KFCC	Helena, Mont.	1210	248	10
KFCF	Walla Walla, Wash.	1170	256	100
KFCY	Le Mars, Ia.	Call signal changed to KWUC		
KFCZ	Omaha, Neb.	1160	258	50
KFDD	Boise, Idaho	1080	278	50
KFDH	Tucson, Ariz.	1160	258	50
KFDJ	Corvallis, Ore.	1060	282.8	750
KFDM	Beaumont, Tex.	950	315.6	500
KFDX	Shreveport, La.	1200	250	100
KFDY	Brookings, S. Dak.	1100	273	100
KFDZ	Minneapolis, Minn.	1300	231	10
KFEC	Portland, Ore.	1210	248	50
KFEL	Denver, Colo.	1180	254	50
KFEQ	Oak, Neb.	1120	268	500
KFER	Fort Dodge, Ia.	Changes pending		
KFEY	Kellogg, Idaho	1290	233	10
KFFP	Moberly, Mo.	1240	242	50
KFFV	Lamoni, Ia.	1200	250	100
KFGC	Alexandria, La.	1090	275	50
KFGD	Baton Rouge, La.	1120	268	100
KFGH	Chickasha, Okla.	Call signal changed to KOCW		
KFGI	Stanford University, Cal.	1110	270	500
KFGJ	Boone, Ia.	1330	226	10
KFGK	Orange, Texas	1200	250	500
KFHA	Gunnison, Colo.	1190	252	50
KFHL	Oskaloosa, Ia.	1250	240	10
KFI	Los Angeles, Cal.	640	468.5	3000
KFIF	Portland, Ore.	1210	248	100
KFIO	Spokane, Wash.	1130	266	100
KFIQ	Yakima, Wash.	1170	256	100
KFIU	Juneau, Alaska	1330	226	10
KFIZ	Fondulac, Wisc.	1100	273	100

Two

Canadian Broadcasting Stations

CALL SIGNAL	LOCATION	FREQUENCY IN KCYS.	WAVE-LENGTH IN METERS	POWER IN WATTS
CFAC	Calgary, Alta.	690	434.5	500
CFCA	Toronto, Ont.	840	356.9	500
CFCH	Montreal, P. Q.	730	410.7	1650
CFCH	Iroquois Falls, Ont.	600	499.7	250
CFCK	Edmonton, Alta.	580	516.9	100
CFCN	Calgary, Alta.	690	434.5	750
CFCO	Vancouver, B. C. (Not Active)	730	410.7	5
CFCU	Hamilton, Ont.	880	340.7	500
CFCT	Victoria, B. C.	910	329.5	500
CFCY	Charlottetown, P. E. I.	960	312.3	50
CFCK	Thorold, Ont.	1210	247.8	75
CFQC	Saskatoon, Sask.	910	329.5	500
CFRC	Kingston, Ont.	1120	267.7	500
CFXC	New Westminster, B. C.	1030	291.1	20
CFYC	Burnaby, B. C.	730	410.7	500
CHCS	Hamilton, Ont. (Not Active)	880	340.7	10
CHIC	Toronto, Ont.	840	356.9	500
CHNC	Toronto, Ont.	840	356.9	500
CHSC	Unity, Sask.	840	356.9	250
CHUC	Saskatoon, Sask.	910	329.5	50
CHXC	Ottawa, Ont.	690	434.5	250
CHYC	Montreal, P. Q.	730	410.7	850
CJCA	Edmonton, Alta.	580	516.9	500
CJCD	Toronto, Ont.	840	356.9	50
CJGC	London, Ont.	910	329.5	50
CJJC	Burnaby, B. C.	730	410.7	500
CJSC	Toronto, Ont.	840	356.9	500
CJWC	Saskatoon, Sask.	910	329.5	250
CKAC	Montreal, P. Q.	730	410.7	1200
CKDC	Vancouver, B. C.	730	410.7	1000
CKCK	Regina, Sask.	630	475.9	500
CKLO	Toronto, Ont.	840	356.9	500
CKCO	Ottawa, Ont.	690	434.5	100
CKCW	Durham Co., Ont. (Not Active)	910	329.5	5000
CKFC	Vancouver, B. C.	730	410.7	50
CKOC	Hamilton, Ont.	880	340.7	50
CKY	Winnipeg, Man.	780	384.4	500
CNRA	Moncton, N. B.	960	312.3	500
CNRC	Calgary, Alta.	Uses stations CFAC or CFNC		
CNRE	Edmonton, Alta.	Uses station CJCA		
CNRM	Montreal, P. Q.	Uses station CHYC, CKAC or CFCC		
CNRO	Ottawa, Ont.	690	434.5	500
CNRR	Regina, Sask.	Uses station CKCK		
CNRS	Saskatoon, Sask.	Uses station CFQC		
CNRT	Toronto, Ont.	Uses station CFCA		
CNRV	Vancouver, B. C.	1030	291.1	500
CNRW	Winnipeg, Man.	Uses station CKY		

Fifteen

CALL SIGNAL	LOCATION	FREQUENCY IN KCYS.	WAVE-LENGTH IN METERS	POWER IN WATTS
KFOC	Taft, Cal.	1300	231	100
KFOH	Burlingame, Cal.	Call signal changed to KFOB		
KFOQ	Iowa City, Ia.	1340	224	10
KFOR	Oklahoma, Okla.	Changes pending		
KFOT	Denison, Tex.	1190	252	20
KFOU	Holy City, Cal.	1380	217.3	100
KFQW	North Bend, Wash.	1390	215.7	50
KFOY	Belden, Neb.	Ceased activities August, 1925		
KFQZ	Hollywood, Cal.	1330	226	50
KFRB	Beeville, Tex.	1210	248	250
KFRD	San Francisco, Cal.	1120	268	50
KFRH	Grafton, N. Dak.	Changes pending		
KFRL	Grand Forks, N. Dak.	Ceased activities October, 1925		
KFRM	Fort Sill, Okla.	1240	242	50
KFRQ	Portland, Ore.	Ceased activities June, 1925		
KFRU	Bristow, Okla.	Ceased activities October, 1925		
KFRV	Columbia, Miss.	600	499.7	500
KFRW	Olympia, Wash.	1370	218.8	50
KFRX	Pullman, Wash.	1380	217.3	10
KFRY	State College, N. Mex.	1130	266	50
KFRZ	Hartington, Neb.	1350	222	15
KFSC	Los Angeles	1090	275	500
KFSY	Helena, Mont.	Ceased activities October, 1925		
KFU	Gridley, Cal.			
KFUJ	Breckenridge, Minn.	1240	242	50
KFUL	Galveston, Tex.	1160	258	10
KFUM	Colorado Springs, Colo.	1240	242	100
KFUD	St. Louis, Mo.	550	545.1	500
KFUP	Denver, Colo.	1280	234	50
KFUR	Ogden, Utah	1340	224	50
KFUS	Oakland, Cal.	1170	256	50
KFUT	Salt Lake City, Utah	1150	261	100
KFUV	San Leandro, Cal.	1340	224	50
KFVU	Springfield, Mo.	Ceased activities October, 1925		
KFVY	Butte, Mont.	Ceased activities August, 1925		
KFVZ	Virginia, Minn.	Ceased activities October, 1925		
KFVC	Camden, Ark.	Ceased activities August, 1925		
KFVD	San Pedro, Cal.	1460	205.4	50
KFVE	St. Louis, Mo.	1250	240	500
KFVF	Hollywood, Cal.	1440	208.2	250
KFVG	Independence, Kans.	1270	236	10
KFVH	Manhattan, Kans.	1370	218.8	15
KFVI	Houston, Tex.	1210	248	10
KFVJ	San Jose, Cal.	1330	226	500
KFVK	Sacramento, Cal.	Ceased activities August, 1925		
KFVL	Vancouver, Wash.	Ceased activities August, 1925		
KFVN	Welcome, Minn.	1320	227	10
KFVO	Kirksville, Mo.	Call signal changed to KFKZ		
KFVR	Denver, Colo.	1220	246	50
KFVS	Cape Girardeau, Mo.	1340	224	50
KFVU	Eureka, Cal.	1430	209.7	5
KFVW	San Diego, Cal.	1200	246	500
KFVX	Bentonville, Ark.	1270	236	10

Four

CALL SIGNAL	LOCATION	FREQUENCY IN KCYS.	WAVE-LENGTH IN METERS	POWER IN WATTS
WOAX	Trenton, N. J.	1250	240	500
WOC	Davenport, Ia.	620	483.6	5000
WOCB	Sycamore, Ill.	1460	205.4	10
WOCJ	Jamestown, N. Y.	1090	275	15
WODA	Paterson, N. J.	1340	224	250
WOI	Ames, Ia.	1110	270	750
WOK	Homewood, Ill.	1380	217.3	500
WOKO	New York, N. Y.	1287	233	50
WOO	Philadelphia, Pa.	590	508.2	500
WOQ	Kansas City, Mo.	1080	278	1000
WOR	Newark, N. J.	740	405.2	500
WORD	Batavia, Ill.	1090	275	5000
WOS	Jefferson City, Mo.	680	440.9	500
WOWL	New Orleans, La.	1110	270	100
WOWO	Fort Wayne, Ind.	1320	227	500
WPAK	Agricultural College, N. Dak.	1090	275	50
WPAZ	Charlestown, W. Va.	Changes pending		
WPCC	Chicago, Ill.	1160	258	500
WPDQ	Buffalo, N. Y.	1460	205.4	500
WPG	Atlantic City, N. J.	1000	299.8	500
WPRC	Harrisburg, Pa.	1390	215.7	100
WPSC	State College, Pa.	1150	261	500
WQAA	Parkesburg, Pa.	1360	220	500
WQAC	Amarilla, Tex.	1280	234	100
WQAE	Springfield, Vt.	1220	246	50
WQAM	Miami, Fla.	1120	268	100
WQAN	Scranton, Pa.	1200	250	100
WQAO	New York, N. Y.	833	360	100
WQAS	Lowell, Mass.	Changes pending		
WQJ	Chicago, Ill.	670	447.5	500
WRAA	Houston, Tex.	Changes pending		
WRAF	Laporte, Ind.	1340	224	100
WRAK	Escanaba, Mich.	1170	256	100
WRAM	Galesburg, Ill.	1230	244	100
WRAV	Yellow Springs, Ohio	1140	263	100
WRAX	Reading, Pa.	1260	238	10
WRBC	Gloucester, N. J.	1120	268	250
WRC	Valparaiso, Ind.	1080	278	500
WRC	Washington, D. C.	639	469	1000
WREO	Lansing, Mich.	1050	285.5	500
WRHF	Washington, D. C.	1170	256	50
WRHM	Minneapolis, Minn.	1190	252	50
WRK	Hamilton, Ohio	1110	270	200
WRM	Urbana, Ill.	1100	273	500
WRMU	New York, N. Y. (portable)	1270	236	100
WRNY	New York, N. Y.	1160	258	500
WRR	Dallas, Tex.	1150	261	350
WRST	Bay Shore, N. Y.	1390	215.7	250
WRVA	Richmond, Va.	1170	256	1000
WRW	Tarrytown, N. Y.	1110	273	500
WSAC	Clemson College, S. C.	Ceased activities October, 1925		
WSAD	Providence, R. I.	Ceased activities June, 1925		
WSAG	St. Petersburg, Fla.	Ceased activities August, 1925		

Thirteen

CALL SIGNAL	LOCATION	FREQUENCY IN KCYS.	WAVE-LENGTH IN METERS	POWER IN WATTS
WJZ	New York, N. Y.	660	454.3	1000
WKAA	Cedar Rapids, Ia.	1080	278	500
WKAD	East Providence, R. I.	1250	240	20
WKAF	Milwaukee, Wis.	1150	261	250
WKAP	Cranston, R. I.	1280	234	50
WKAQ	San Juan, Porto Rico	880	340.7	500
WKAR	East Lansing, Mich.	1050	285.5	1000
WKAV	Laconia, N. H. (portable)	1430	209.7	50
WKBB	Joliet, Ill.	1400	214.2	100
WKBE	Webster, Mass.	1300	231	100
WKBC	Chicago, Ill.	1390	215.7	100
WKBK	New York, N. Y.	1430	209.7	500
WKRC	Cincinnati, Ohio	920	325.9	1000
WKY	Oklahoma, Okla.	1090	275	100
WLAL	Tulsa, Okla.	1200	250	150
WLAP	Louisville, Ky.	1090	275	20
WLAX	Greencastle, Ind.	1300	231	10
WLB	Minneapolis, Minn.	1080	278	500
WLBL	Stevens Point, Wis.	1080	278	500
WLIB	Elgin (near), Ill.	990	302.8	1500
WLIT	Philadelphia, Pa.	760	394.5	500
WLS	Chicago, Ill.	870	344.6	1500
WLTS	Chicago, Ill.	1160	258	100
WLW	Harrison, Ohio	710	422.3	5000
WLWL	New York, N. Y.	1040	288.3	1000
WMAC	Cazenovia, N. Y.	1090	275	100
WMAF	Dartmouth, Mass.	680	440.9	1000
WMAK	Lockport, N. Y.	1130	266	500
WMAL	Washington, D. C.	1410	212.6	15
WMAN	Columbus, Ohio	1080	278	50
WMAQ	Chicago, Ill.	670	447.5	500
WMAZ	St. Louis	1210	248	100
WMAZ	Macon, Ga.	1150	261	500
WMBB	Chicago, Ill.	1200	250	500
WMBB	Detroit, Mich.	1170	256	100
WMBF	Miami Beach, Fla.	780	384.4	500
WMC	Memphis, Tenn.	600	499.7	500
WMC	Hoboken, N. J.	880	340.7	500
WMCA	Boston, Mass.	1200	250	100
WNAB	Boston, Mass.	1070	280.2	500
WNAC	Norman, Okla.	1180	254	250
WNAD	Butler, Mo.	1300	231	20
WNAR	Philadelphia, Pa.	1200	250	100
WNAT	Knoxville, Tenn.	1290	233	500
WNAV	Yankton, S. Dak.	1230	244	100
WNAX	New Bedford, Mass.	1210	248	250
WNBH	Newark, N. J.	1290	233	100
WNJ	Knoxville, Tenn.	1120	268	500
WNOX	New York, N. Y.	570	526	1000
WNYC	Lima, Ohio	1150	261	10
WOAC	San Antonio, Tex.	760	394.5	2000
WOAI	Lawrenceburg, Tenn.	1060	282.8	500
WOAN	Omaha, Neb.	570	526	1000

Twelve

CALL SIGNAL	LOCATION	FREQUENCY IN KCYS.	WAVE-LENGTH IN METERS	POWER IN WATTS
KFVY	Albuquerque, N. Mex.	1200	250	10
KFWA	Ogden, Utah	1150	261	500
KFWB	Hollywood, Cal.	1190	252	500
KFWC	Upland, Cal.	1420	211.1	50
KFWF	St. Louis, Mo.	1400	214.2	250
KFWH	Chico, Cal.	1180	254	100
KFWI	South San Francisco, Cal.	1330	226	500
KFWM	Oakland, Cal.	1430	206.8	500
KFWO	Avalon, Cal.	1420	211.1	250
KFWP	Brownsville, Tex.	1400	214.2	10
KFWU	Pineville, La.	1260	238	100
KFWV	Portland, Ore.	1410	212.6	50
KFXB	Big Bear Lake, Cal.	1480	202.6	500
KFXC	Santa Maria, Cal.	1430	209.7	100
KFXD	Logan, Utah	1460	205.4	10
KFXE	Waterloo, Ia.	1270	236	10
KFXF	Colorado Springs, Colo.	1200	250	500
KFXH	El Paso, Tex.	1240	242	50
KFXJ	Colorado (portable)	1390	215.7	10
KFXM	Beaumont, Tex.	1320	227	10
KFXZ	Flagstaff, Ariz.	1460	205.4	50
KFYD	Muscataine, Ia.	1170	256	250
KFYF	Oxnard, Cal.	1460	205.4	10
KFYJ	Houston, Tex.	1260	238	10
KFYR	Bismarck, N. Dak.	1210	248	10
KGB	Tacoma, Wash.	1200	250	50
KGO	Oakland, Cal.	830	361.2	3000
KGTT	San Francisco, Cal.	1280	234	50
KGU	Honolulu, Hawaii	1110	270	500
KGW	Portland, Ore.	610	491.5	500
KGY	Lacey, Wash.	1220	246	5
KHJ	Los Angeles, Cal.	740	405.2	500
KHQ	Spokane, Wash.	1100	273	500
KJBS	San Francisco, Cal.	1360	220	500
KJR	Seattle, Wash.	780	384.4	1000
KLDS	Independence, Mo.	680	440.9	1000
KLS	Oakland, Cal.	1200	252	250
KLX	Oakland, Cal.	590	508.2	500
KLZ	Denver, Colo.	1130	266	250
KMA	Shenandoah, Ia.	1190	252	500
KMJ	Fresno, Cal.	1280	234	50
KMO	Tacoma, Wash.	1200	250	100
KNRC	Los Angeles, Cal.	—	—	—
KNX	Los Angeles, Cal.	890	336.9	5000
KOA	Denver, Colo.	930	322.4	2000
KOB	State College, N. Mex.	860	348.6	750
KOCH	Omaha, Neb.	1160	258	250
KOCW	Chickasha, Okla.	1190	252	200
KOIL	Council Bluffs, Ia.	1080	278	500
KOP	Detroit, Mich.	1080	277.6	500
KPO	San Francisco, Cal.	700	428.3	1000
KPPC	Pasadena, Cal.	1310	229	50
KPRC	Houston, Tex.	1010	296.9	500

Five

CALL SIGNAL	LOCATION	FREQUENCY IN KCYS.	WAVE-LENGTH IN METERS	POWER IN WATTS
WCBS	New York, N. Y.	949	316	500
WGBT	Greenville, S. C.	—	—	—
WGBU	Fulford-by-Sea, Fla.	1080	278	500
WGBW	Spring Valley, Ill.	1170	256	10
WGBX	Orono, Me.	1190	252	100
WGBY	New Lebanon, Ohio	—	—	—
WGCP	Newark, N. J.	1190	252	500
WGES	Oak Park, Ill.	1200	250	500
WGHB	Clearwater, Fla.	1130	266	500
WGHP	Detroit, Mich.	1110	270	1500
WGMU	Richmond Hill, N. Y. (portable)	1270	236	100
WGN	Chicago, Ill.	810	370.2	1000
WGR	Buffalo, N. Y.	940	319	750
WGST	Atlanta, Ga.	1110	270	500
WGY	Schenectady, N. Y.	790	379.5	5000
WHA	Madison, Wis.	560	535.4	750
WHAD	Milwaukee, Wis.	1090	275	500
WHAC	Cincinnati, Ohio	1300	231	100
WHAM	Rochester, N. Y.	1080	278	500
WHAP	New York, N. Y.	1250	240	100
WHAR	Atlantic City, N. J.	1090	275	500
WHAS	Louisville, Ky.	750	399.8	500
WHAT	Minneapolis, Minn.	—	—	—
WHAV	Wilmington, Del.	1130	266	100
WHAZ	Troy, N. Y.	790	379.5	1000
WHB	Kansas City, Mo.	820	365.6	500
WHBA	Oil City, Pa.	1200	250	10
WHBB	Stevens Point, Wis.	—	—	—
WHBC	Canton, Ohio	1180	254	10
WHBD	Bellefontaine, Ohio	1350	222	20
WHBF	Rock Island, Ill.	1350	222	100
WHBG	Harrisburg, Pa.	1300	231	20
WHBH	Culver, Ind.	1300	222	10
WHBI	Chesaming, Mass.	—	—	—
WHBJ	Fort Wayne, Ind.	1280	234	10
WHBK	Ellsworth, Me.	1300	231	10
WHBL	Logansport, Ind.	1390	215.7	50
WHBM	Chicago, Ill. (portable)	1290	233	20
WHBN	St. Petersburg, Fla.	1260	238	10
WHBO	Pawtucket, R. I.	—	—	—
WHBP	Johnstown, Pa.	1170	256	100
WHBQ	Memphis, Tenn.	1290	233	50
WHBR	Cincinnati, Ohio	1390	215.7	—
WHBS	Mechanicsburg, Ohio	—	—	—
WHBT	Downers Grove, Ill.	—	—	—
WHBU	Anderson, Ind.	1370	218.8	10
WHBV	Columbus, Ga.	—	—	—
WHBW	Philadelphia, Pa.	1390	215.7	100
WHBX	Punxsutawny, Pa.	—	—	—
WHBY	West De Pere, Wis.	1200	250	50
WHDI	Minneapolis, Minn.	1080	278	500
WHEC	Rochester, N. Y.	1160	258	100
WHK	Cleveland, Ohio	—	—	—

Ten

CALL SIGNAL	LOCATION	FREQUENCY IN KCYS.	WAVE-LENGTH IN METERS	POWER IN WATTS
WARC	Medford Hillside, Mass.	1150	261	100
WBAA	West Lafayette, Ind.	1100	273	500
WBAK	Harrisburg, Pa.	1090	275	500
WBAO	Decatur, Ill.	1110	270	100
WBAP	Fort Worth Tex.	630	475.9	1500
WBAV	Columbus, Ohio	1020	293.9	500
WBAX	Wilkes-Barre, Pa.	1170	256	100
WBBG	Mattapoisett, Mass.	1210	248	100
WBBL	Richmond, Va.	1310	229	100
WBBM	Chicago, Ill.	1330	226	1500
WBPP	Petoskey, Mich.	1260	238	200
WBRR	Staten Island, N. Y.	1100	273	500
WBSS	New Orleans, La.	1190	252	50
WBBU	Monmouth, Ill.	1340	224	10
WBBV	Johnstown, Pa.	—	—	—
WBBW	Norfolk, Va.	1350	222	50
WBBY	Charleston, S. C.	1120	268	10
WBBZ	Indianapolis, Ind.	—	—	—
WBBZ	Chicago, Ill. (Portable)	1390	215.7	50
WBCN	Chicago, Ill.	1130	266	500
WBDC	Grand Rapids, Mich.	1170	256	50
WBES	Takoma Park, Md.	1350	222	100
WBNY	New York, N. Y.	1430	209.7	500
WBOQ	Richmond Hill, N. Y.	1270	236	100
WBRC	Birmingham, Ala.	1210	248	10
WBRE	Wilkes-Barre, Pa.	1300	231	10
WBS	Newark, N. J.	—	—	—
WBT	Charlotte, N. C.	—	—	—
WBZ	Springfield, Mass.	900	333.1	2000
WBZA	Boston, Mass.	1240	242	250
WCAC	Mansfield, Conn.	1090	275	500
WCAD	Canton, N. Y.	1140	263	250
WCAE	Pittsburgh, Pa.	650	461.3	500
WCAH	New Orleans, La.	—	—	—
WCAI	Columbus, Ohio	1130	266	500
WCAL	University Pl., Neb.	1180	254	500
WCAM	Northfield, Minn.	890	336.9	500
WCAN	Baltimore, Md.	1090	275	100
WCAP	Washington, D. C.	640	468.5	500
WCAR	San Antonio, Tex.	1140	263	500
WCAT	Rapid City, S. Dak.	1250	240	50
WCAU	Philadelphia, Pa.	1080	278	500
WCAX	Burlington, Vt.	1200	250	100
WCAY	Milwaukee, Wis.	—	—	—
WCBA	Carthage, Ill.	1220	246	50
WCBB	Allentown, Pa.	1180	254	500
WCBC	Ann Arbor, Mich.	—	—	—
WCBD	Zion, Ill.	870	344.6	5000
WCBE	New Orleans, La.	1140	263	5
WCBG	Pascagoula, Miss.	1120	268	10
WCBH	Oxford (near) Miss.	1240	241	19
WCBJ	Bemis, Tenn.	—	—	—
WCBJ	Jennings, La.	—	—	—

Seven

CALL SIGNAL	LOCATION	FREQUENCY IN KCYS.	WAVE-LENGTH IN METERS	POWER IN WATTS
KPSN	Pasadena, Cal.	950	315.6	1000
KQP	Portland, Ore.	1410	212.6	500
KQV	Pittsburgh, Pa.	1090	275	500
KQW	San Jose, Cal.	1300	231	500
KRE	Berkeley, Cal.	1170	256	50
KSAC	Manhattan, Kans.	880	340.7	500
KSD	St. Louis, Mo.	550	545.1	750
KSL	Salt Lake City, Utah	1000	299.8	1000
KSO	Clarinda, Ia.	1240	242	500
KTAB	Oakland, Cal.	1250	240	1000
KTBI	Los Angeles, Cal.	1021	293.9	750
KTBR	Portland, Ore.	1140	263	50
KTCL	Seattle, Wash.	980	305.9	1000
KTHS	Hot Springs, Ark.	800	274.8	500
KTW	Seattle, Wash.	660	454.3	1000
KUO	San Francisco, Cal.	1200	250	150
KUOM	Missoula, Mont.	1230	244	250
KUPR	Omaha, Neb.	1110	270	50
KUSD	Vermilion, S. Dak.	1080	278	100
KUT	Austin, Tex.	1300	231	500
KWG	Stockton, Cal.	1210	248	50
KWKC	Kansas City, Mo.	1270	236	100
KWUC	LeMars, Ia.	1190	252	50
KWVG	Brownsville, Tex.	1080	278	500
KYW	Chicago, Ill.	560	535.4	1500
KZKZ	Manila, Philippines	1110	270	100
KZM	Oakland, Cal.	1250	240	100
KZRO	Manila, Philippines	1350	222	500
WAAB	New Orleans, La.	1120	268	100
WAAC	New Orleans, La.	1090	275	100
WAAD	Cincinnati, Ohio	1160	258	25
WAAF	Chicago, Ill.	1080	278	200
WAAM	Newark, N. J.	1140	263	500
WAAW	Omaha, Neb.	770	389.4	500
WABA	Lake Forest, Ill.	Ceased activities October, 1925		
WABB	Harrisburg, Pa.	Ceased activities October, 1925		
WABC	Asheville, N. C.	1180	254	10
WABI	Bangor, Me.	1250	240	100
WABL	Storrs, Conn.	Changed to WCAC Mansfield, Conn.		
WABO	Rochester, N. Y.	1080	278	100
WABQ	Haverford, Pa.	1150	261	100
WABR	Toledo, Ohio	1140	263	50
WABW	Wooster, Ohio	1450	206.8	50
WABX	Mount Clemens (near), Mich.	1220	246	500
WABY	Philadelphia, Pa.	1240	242	50
WABZ	New Orleans, La.	1090	275	50
WADC	Akron, Ohio	1160	258	100
WAFD	Port Huron, Mich.	1090	275	500
WAHG	Richmond Hill, N. Y.	950	315.6	500
WAIT	Taunton, Mass.	1310	229	10
WAMD	Minneapolis, Minn.	1230	244	500
WAPI	Auburn, Ala.	1210	248	500

Six

CALL SIGNAL	LOCATION	FREQUENCY IN KCYS.	WAVE-LENGTH IN METERS	POWER IN WATTS
WHN	New York, N. Y.	830	361.2	500
WHO	Des Moines, Ia.	570	526	500
WHT	Deerfield, Ill.	750	400	1500
WIAD	Philadelphia, Pa.	1200	250	100
WIAK	Omaha, Neb.	Changes pending		
WIAS	Burlington, Ia.	1180	254	100
WIBA	Madison, Wis.	1270	236	100
WIBC	St. Petersburg, Fla.	1350	222	100
WIBD	Joliet, Ill.	Ceased activities October, 1925		
WIBE	Martinsburg, W. Va.	Ceased activities August, 1925		
WIBF	Wheatland, Wis.	Changes pending		
WIBC	Elkins Park, Pa.	1350	222	50
WIBH	New Bedford, Mass.	1430	209.7	5
WIBI	Flushing, N. Y.	1370	218.8	50
WIBJ	Chicago, Ill. (portable)	1390	215.7	50
WIBK	Toledo, Ohio	Ceased activities October, 1925		
WIBL	Chicago, Ill. (portable)	Ceased activities August, 1925		
WIBM	Chicago, Ill. (portable)	1390	215.7	10
WIBO	Chicago, Ill.	1330	226	1000
WIBP	Meridian, Miss.	Ceased activities October, 1925		
WIBQ	Farina, Ill.	1460	205.4	5
WIBR	Weirton, W. Va.	1220	246	50
WIBS	Elizabeth, N. J.	1480	202.6	20
WIBU	Poynette, Ws.	1350	222	20
WIBV	Henderson, N. C.	1140	263	25
WIBW	Logansport, Ind.	1360	220	100
WIBX	Utica, N. Y.	1460	205.4	5
WIBZ	Montgomery, Ala.	1300	231	10
WIL	St. Louis, Mo.	1100	275	250
WIP	Philadelphia, Pa.	590	508.2	500
WJAD	Waco, Tex.	850	352.7	500
WJAG	Norfolk, Neb.	1110	270	250
WJAK	Greentown, Ind.	1180	254	100
WJAM	Cedar Rapids, Ia.	1120	268	100
WJAR	Providence, R. I.	980	305.9	500
WJAS	Pittsburg, Pa.	930	322.4	1500
WJAZ	Chicago, Ill.	1120	268	100
WJBA	Joliet, Ill.	1450	206.8	50
WJBB	St. Petersburg, Fla.	1450	206.8	10
WJBC	La Salle, Ill.	1280	234	100
WJBD	Ashland, Wis.	1290	233	100
WJBG	Charlotte, N. C.	1340	224	10
WJBI	Red Bank, N. J.	1370	218.8	250
WJBK	Joliet, Ill.	Call signal changed to WCLS		
WJBL	Ypsilanti, Mich.	1290	233	10
WJBM	Decatur, Ill.	1110	270	500
WJBN	Sycamore, Ill.	1170	256	10
WJBQ	Buffalo, N. Y.	1370	218.8	50
WJBK	Lewisburg, Pa.	1420	211.1	100
WJBD	Granville, Ohio	1380	217.3	10
WJDD	Mooseheart, Ill.	990	302.8	500
WJDR	Pontiac, Mich.	580	517	1500
WJY	New York, N. Y.	740	405.2	1000

Eleven

CALL SIGNAL	LOCATION	FREQUENCY IN KCYS.	WAVE-LENGTH IN METERS	POWER IN WATTS
WCBM	Baltimore, Md.	1310	229	50
WCBQ	Nashville, Tenn.	1270	236	100
WCBR	Providence, R. I. (portable)	1460	205	30
WCBU	Arnold, Pa.	Ceased activities October, 1925		
WCCO	St. Paul, Minn.	720	416.4	5000
WCEE	Elgin (near), Ill.	1090	275	1000
WCK	St. Louis, Mo.	Call signal changed to WSBF		
WCLO	Camp, Wis.	1300	231	50
WCLS	Joliet, Ill.	1400	214.2	100
WCM	Austin, Tex.	1120	268	250
WCSH	Portland, Me.	1170	256	500
WCTS	Worcester, Mass.	Call changed to WTAC		
WCUW	Worcester, Mass.	1260	238	250
WCWS	Providence, R. I.	1430	209.7	100
WCX	Detroit, Mich.	Now operating in conjunction with WJR		
WDAD	Nashville, Tenn.	1330	226	150
WDAE	Tampa, Fla.	1100	273	250
WDAF	Kansas City, Mo.	820	365.6	1000
WDAG	Amarillo, Tex.	1140	263	100
WDAH	El Paso	Ceased activities August, 1925		
WDAY	Fargo, N. Dak.	1150	261	50
WDBC	Lancaster, Pa.	1160	258	50
WDBE	Atlanta, Ga.	1110	270	100
WDBJ	Roanoke, Va.	1310	229	50
WDBK	Cleveland, Ohio	1320	227	100
WDBO	Winter Park, Fla.	1250	240	100
WDBP	Superior, Wis.	Ceased activities		
WDBQ	Salem, N. J.	1280	234	10
WDBR	Boston, Mass.	1150	261	100
WDBS	Dayton, Ohio	Call signal changed to WSMK		
WDBX	Columbia, Tenn.	Ceased activities June, 1925		
WDBY	New York, N. Y.	Call signal changed to WOKO		
WDBZ	Chicago, Ill.	Call signal changed to WPCC		
WDCH	Kingston, N. Y.	1290	233	10
WDCI	Hanover, N. H.	1170	256	100
WDM	Washington, D. C.	Changes pending		
WDOD	Chattanooga, Tenn.	1170	256	50
WDWF	Cranston, R. I.	680	440.9	500
WDZ	Tuscola, Ill.	1080	278	100
WEAA	Flint, Mich.	Call changed WFDF		
WEAF	New York, N. Y.	610	492	5000
WEAH	Wichita, Kans.	1120	268	100
WEAI	Ithaca, N. Y.	1180	254	500
WEAJ	Vermilion, S. Dak.	Call signal changed to KUSD		
WEAM	North Plainfield, N. J.	1150	261	250
WEAN	Providence, R. I.	1110	270	250
WEAO	Columbus, Ohio	1020	294	500
WEAR	Cleveland, Ohio	770	389.4	1000
WEAU	Sioux City, Ia.	1090	275	100
WEAY	Houston, Tex.	Ceased activities October, 1925		
WEBA	Highland Park, N. J.	1290	233	15
WEBC	Superior, Wis.	1240	242	100

Eight

CALL SIGNAL	LOCATION	FREQUENCY IN KCYS.	WAVE-LENGTH IN METERS	POWER IN WATTS
WEBD	Anderson, Ind.	1220	246	10
WEBE	Cambridge, Mass.	1280	234	10
WEBH	Chicago, Ill.	810	370.2	1000
WEBJ	New York, N. Y.	1100	273	500
WEBK	Grand Rapids, Mich.	1240	242	20
WEBL	United States (portable)	1330	226	100
WEBM	United States (portable)	1330	226	100
WEBQ	Harrisburg, Ill.	1330	226	10
WEBR	Buffalo, N. Y.	1230	244	100
WEBT	Dayton, Ohio.	1170	256	5
WEBW	Beloit, Wis.	1120	268	500
WEBZ	Savannah, Ga.	1140	263	50
WEEI	Boston, Mass.	630	475.9	500
WEHS	Evanston, Ill.	1480	202.6	20
WEMC	Berrien Springs, Mass.	1050	285.5	500
WENR	Chicago, Ill.	1130	266	1000
WEW	St. Louis, Mo.	1210	248	100
WFAA	Dallas, Tex.	630	475.9	500
WFAM	St. Cloud, Minn.	1100	273	10
WFAP	Lincoln, Neb.	1090	275	500
WFBB	Eureka, Ill.	Ceased activities June, 1925		
WFBC	Knoxville, Tenn.	1200	250	50
WFBD	Philadelphia, Pa.	1280	234	5
WFBE	Seymour, Ind.	1330	226	20
WFBG	Altoona, Pa.	1080	278	100
WFBH	New York, N. Y.	1100	273	500
WFBI	Camden, N. J.	1270	236	250
WFBJ	Collegeville, Minn.	1270	236	50
WFBK	Hanover, N. H.	Changes pending		
WFBM	Syracuse, N. Y.	1190	252	100
WFBN	Indianapolis, Ind.	1120	268	250
WFBQ	Bridgewater, Mass.	Ceased activities August, 1925		
WFBR	Raleigh, N. C.	1190	252	50
WFBY	Baltimore, Md.	1180	254	100
WFBZ	Fort Benjamin, Ind.	Changes pending		
WFCA	Galesburg, Ill.	1180	254	20
WFDF	Flint, Mich.	1280	234	100
WFI	Philadelphia, Pa.	760	394.5	500
WFKB	Chicago, Ill.	1380	217.3	200
WFKL	Brooklyn, N. Y.	1460	205.4	100
WGLA	Lancaster, Pa.	1210	248	10
WGAZ	South Bend, Ind.	Call signal changed to WSBT		
WGAA	Baltimore, Md.	1180	254	100
WGAB	Freeport, N. Y.	1230	244	100
WGBC	Memphis, Tenn.	1080	278	10
WGBF	Evansville, Ind.	1270	236	100
WGBH	Fall River, Mass. (portable)	Changes pending		
WGBI	Scranton, Pa.	1250	240	50
WGBK	Johnstown, Pa.	1210	248	5
WGBL	Elyria, Ohio	1320	227	10
WGBM	Providence, R. I.	1280	234	5
WGBQ	Menomonee, Wis.	1280	234	100
WGBR	Marshfield, Wis.	1310	229	10

Nine



## Most-Demonstrated Set of the Season

From radio as you have known it, to Thorola Islodyne is as great a change as could happen, even in radio! Here is so much of an advance that it seems to put final highest development into view. Thorola Islodyne now brings you radio safe from being surpassed.

Only the Thorola Islodyne principle of *Isolated Power* makes it all possible. Based on the epochal discovery of Thorola Low-Loss Doughnut Coils, Islodyne action literally isolates the radio impulses—keeps them from interfering with each other—from tangling up—from weakening themselves—*keeps all unwanted stations out.*

Sharpest selectivity is certain, wherever you are. Tone is unbelievably pure, since interference is defeated. Superabundant volume is available at extreme distances because power, instead of being wasted, neutralized, or damped, is put fully behind the broadcasting of the one chosen station only.

These amazing results, free from mysterious, unmanageable, disappointing old elements of radio reception, are the regular performance of Thorola Islodyne receivers. Excellence is uniform in all Thorola sets, and throughout the range of reception. Your radio parties proceed as scheduled. Stations come in as logged. Words and music come in *as broadcast!*

It is the latest proof of Thorola eminence, first established by the matchless tonal accuracy of Thorola Loud Speakers. Now there is a complete receiver, Thorola Islodyne, even further ahead. At the Thorola store you can listen to the most-demonstrated radio set.

REICHMANN COMPANY, CHICAGO

Illustrated: 5-tube Thorola Islodyne in Burled Walnut with Circassian top

\$100

New Model 51, Genuine Mahogany Cabinet

\$85

Console Model

\$225

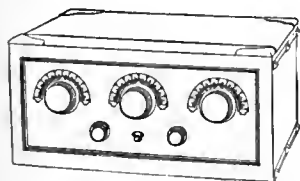

5-tube Thorola Islodyne in smart Thorocco Finish

\$85

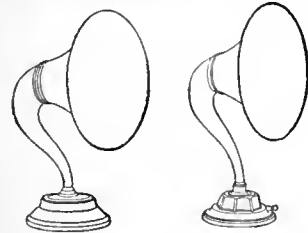

Thorola 4 Speaker

\$25

Thorola Jr. Speaker

\$15



Islodyne action is based on Thorola Low-Loss Doughnut Coils. They bring many Thorola advantages to other receivers

Set of 3 Coils

\$12

Per Coil

\$4

Thorola Low-Loss Straight Line Frequency Condensers can also be bought separately \$5.50 and \$6

Thorola Golden Audio Reproducing Transformer

\$4.50



# Thorola

I S L O D Y N E

# Methods for Controlling Oscillation in R. F. Circuits

The Systems at Present in Use for Neutralizing Radio-Frequency Amplifiers and a Discussion of the Recently Developed "Counterphase" Method for Controlling Oscillations

By JOHN BERNARD

**B**EFORE looking into the future and ascertaining what is in store for the dyed-in-the-wool experimenter and builder of radio circuits, it is well to pause for a moment in consideration of what has gone before.

Without any question, tuned radio frequency amplification, that discarded system of reception of years ago, has again come into its own and is now the general mainstay and backbone of receiver design.

But even up to the present time, the especial and particular difficulties which have accompanied this system of reception are far from being satisfactorily controlled.

Constantly, the birth of a new method for the successful handling and control of radio frequency amplification is heralded as the last word in efficiency and performance—and still we search on.

In brief reconsideration of the many methods of control of radio-frequency amplifiers, it is worthy of mention to restate the particular advantages and disadvantages of this system of amplification.

In the application of Ohm's law, we find that, if for a given voltage, the resistance of a certain circuit be reduced, then a greater current will flow. And conversely, if the resistance be increased then the current will be decreased.

In a radio circuit where a coil is tuned by a variable condenser, a maximum of current will flow in the circuit when the condenser adjusts the circuit to resonance with

the transmitted frequency. Where, in a vacuum tube circuit the grid and plate circuits are in resonance, a maximum of current will flow in each one and the only coupling agent between them is the tube capacity. When such a state of affairs exists, the entire circuit oscillates.

Where high-grade apparatus is employed to cut down the actual resistances of the circuit, sharp tuning of the circuit by the variable tuning element, as shown in Fig. 2, is obtained.

Now if it were possible to utilize such a circuit with its advantage of extra-fine tuning, there would be no obstacle to be overcome or problem to be solved. However, this is not the case. Whenever a circuit is in oscillation, it produces radio frequency energy which, when adjusted in frequency to the frequency of an incoming signal, produces distorted reception, sometimes unintelligible. It is as though two broadcasting stations were transmitting on the same frequency adjustment and were received simultaneously.

Yet if it were possible to prevent the



*N*EARLY every multi-tube receiver in use today employs some form of radio frequency amplification, and the matter of controlling oscillations in such circuits has always been a serious problem. In this article, the various popular methods are reviewed, and a description is offered of a method which differs from the conventional "losser" and from neutralizing schemes. The present arrangement combines resistance and capacity as a method of control, and should arouse a considerable amount of interest, for the idea may have wide application in r.f. circuits.—THE EDITOR

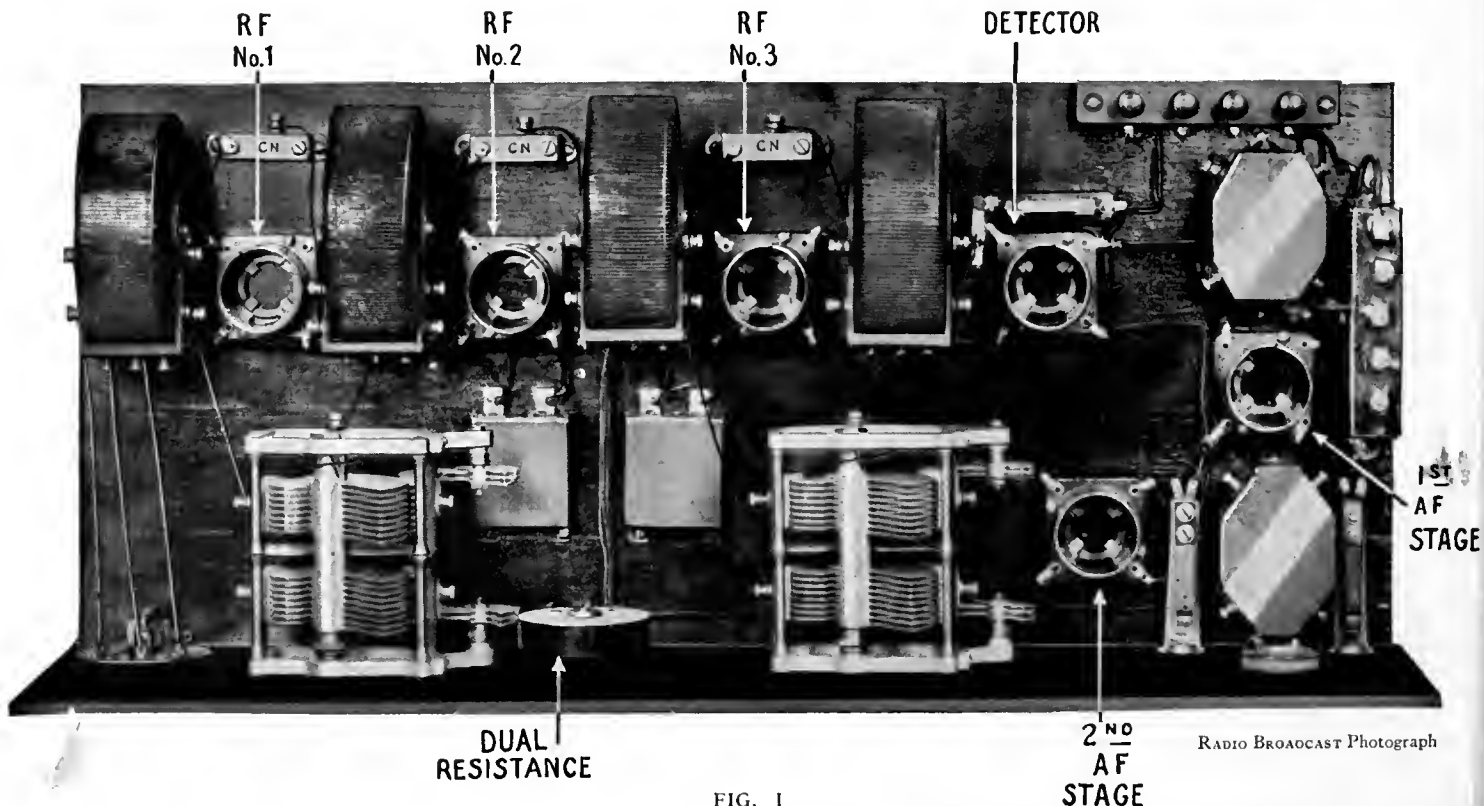

RADIO BROADCAST Photograph

FIG. 1

A base-board layout of the Bremer-Tully "Counterphase" receiver. The rectangular blocks shown above the tube sockets and between the toroidal coils, are the condensers, by means of which the tubes may be adjusted to the correct oscillating point. Note also the extra midget or trimming condensers, which are a part of the large tandem tuning condensers

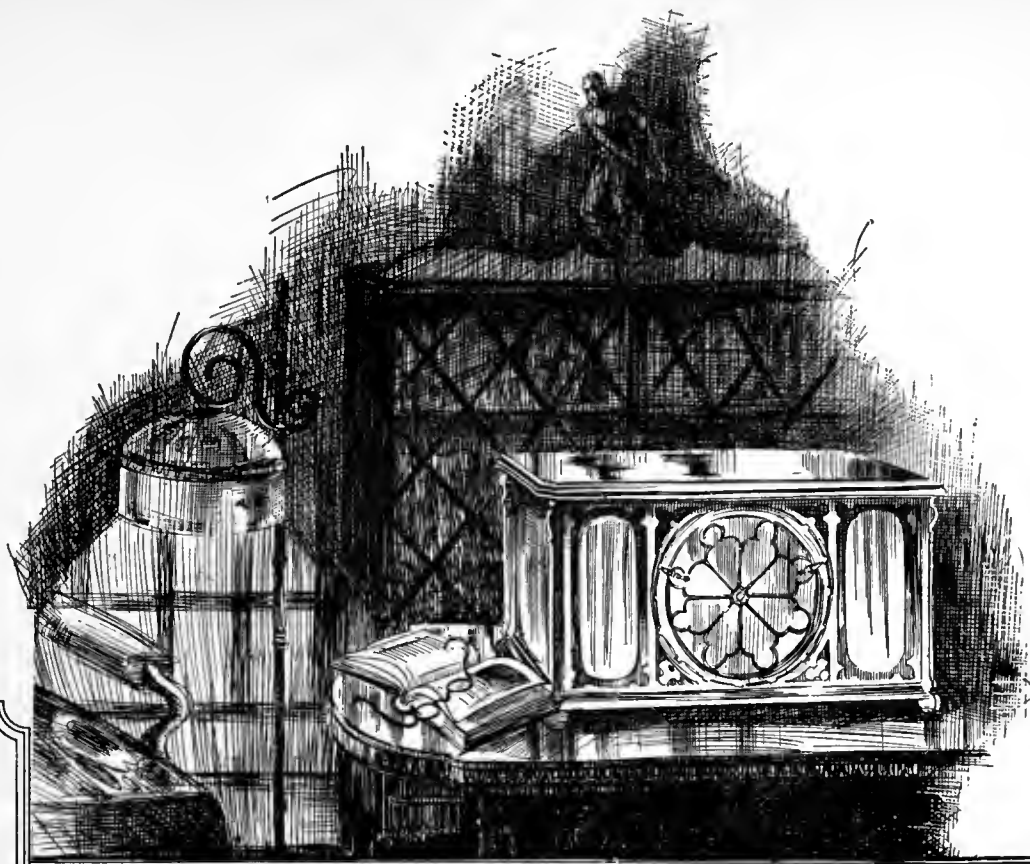

NO DIALS  
 NO PANEL  
 BUILT-IN  
 LOUDSPEAKER

*For the Well Appointed Home*

PEOPLE of taste will instantly recognize in the ULTRADYNE, Model L-3, the long-awaited perfection in *radio-musical instruments*. This new receiver offers complete mastery of the air's riches; effortless operation—as simple as playing a phonograph; and a new artistic form that blends harmoniously with its environment.

Better than the most exacting critics of radio ever demanded, more than the radio authorities themselves predicted. Complete freedom from entangling technicalities. "Belongs" in almost any scheme of furnishings. The perfect harmony of scientific skill and artistic genius.

Radio never held out more attractions for you than this new kind of receiver makes possible. See and hear it demonstrated at the higher standard radio shops and department stores.

**\$135.00**

*West of the Rocky Mountains \$140*

The ULTRADYNE, Model L-3, is a six-tube receiver employing the fundamental principles of the best circuits greatly refined and marvelously simplified. No dials—no panel; just two inconspicuous levers which constitute a station-selector. Volume adjustment, the only other control. Beautifully duco finished, duo-toned panelled mahogany cabinet.



Chief Engineer of this Company, and formerly Radio Research Engineer with the French Signal Corps, Radio Research Laboratories.

To protect the public, Mr. Lacault's personal monogram seal (R.E.L.) is placed on the assembly lock bolts of all genuine ULTRADYNE Model L-3 Receivers. All Ultradyne Receivers are guaranteed so long as these seals remain unbroken.

Designed by R. E. Lacault, E.E.,

*Write for illustrated descriptive folder*

**ULTRADYNE**  
 MODEL L-3



PHENIX RADIO CORP., 116-C East 25th St. NEW YORK



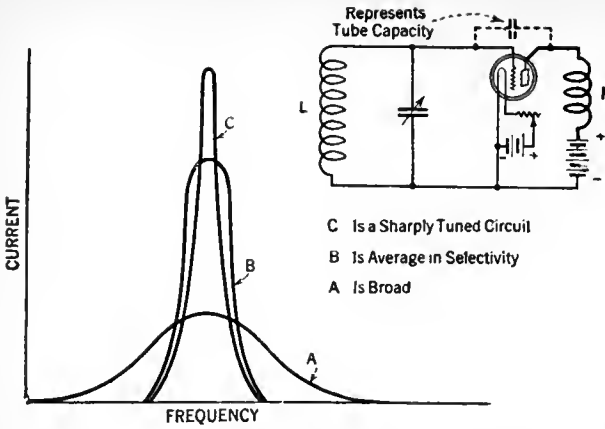

FIG. 2

The circuit above depends, for selectivity, upon the resistance of the tuned portion, represented by the coil L and the variable condenser shunting it. If the resistance is high, the tuning response will be broad as in the curve A. As the resistance is decreased the selectivity becomes sharper, as depicted on curves B, and C. Also, as the resistance of the circuit is decreased, more current will flow in the grid and plate circuits and oscillations will be produced due to the coupling between these two circuits by the inherent capacity of the tube

oscillation, but keep the circuit as sharply tuned to that particular frequency as before, then a distinct and worthwhile advantage would result.

The various systems for stopping this oscillation are known as neutralization methods.

The word itself carries a world of meaning, and implies an equalization or neutralization of the capacity of the tube which is the coupling agent producing the oscillation. In effect, neutralization is the setting up of an equal and opposing voltage which, due to its opposition, prevents unwanted oscillations from taking place in the grid-plate circuit of the tube

in question. The well known neutrodyne system is shown in Fig. 3.

Another system worthy of comparison is that developed by Walter Van B. Roberts. It is shown in Fig. 4. Here, any potential set up in the plate coil P is set up also in the plate coil N, but in opposite relation to that flowing in P. Then through the capacity C, which balances out the tube capacity, this potential is applied to the grid of the tube, effectively preventing any possibility of oscillation because it is equal in potential, and opposite in phase, to that

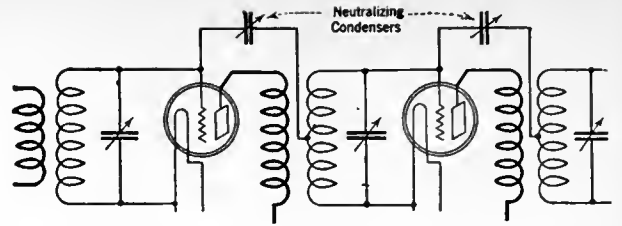

FIG. 3

Professor L. A. Hazeltine is responsible for the neutralization, or balancing-out system shown above. A goodly portion of all the manufactured receivers sold during the past few years incorporated this system using licenses granted under the neutrodyne patents

which might be fed back to the grid of the tube by the coil P through the tube capacity. Yet, even this method is not possible of adjustment independent of frequency.

Absorption systems, still another way, never were regarded as truly a satisfactory neutralization method, and were more correctly termed "losser" systems.

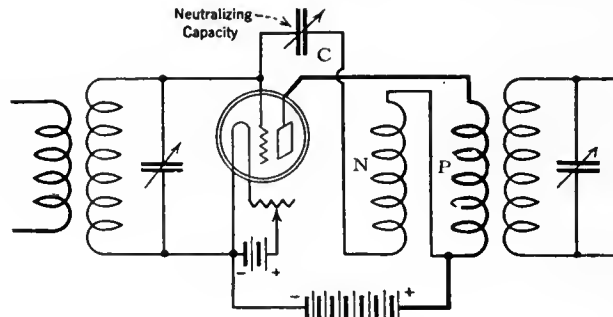

FIG. 4

The Roberts system of neutralization. The coil in series with the neutralizing capacity is connected counter to the plate coil, and produces an effect on the grid, through the neutralizing capacity, equal and opposite to that produced by the plate coil acting through the grid-plate capacity of the tube

OSCILLATION CONTROL METHODS

ONE of the most simple and common methods is to add sufficient resistance to the grid or plate circuit to prevent the possibility of oscillation. Considering the efforts that have been made to reduce resistance in coils and condensers, and the value attributed to such efforts, the fallacy of again deliberately introducing such losses into a circuit is evident. Were it not for the popular delusions, how much more simple it would be to use high-loss coils and condensers in the first place.

Eddy current losses result from placing condensers within the field

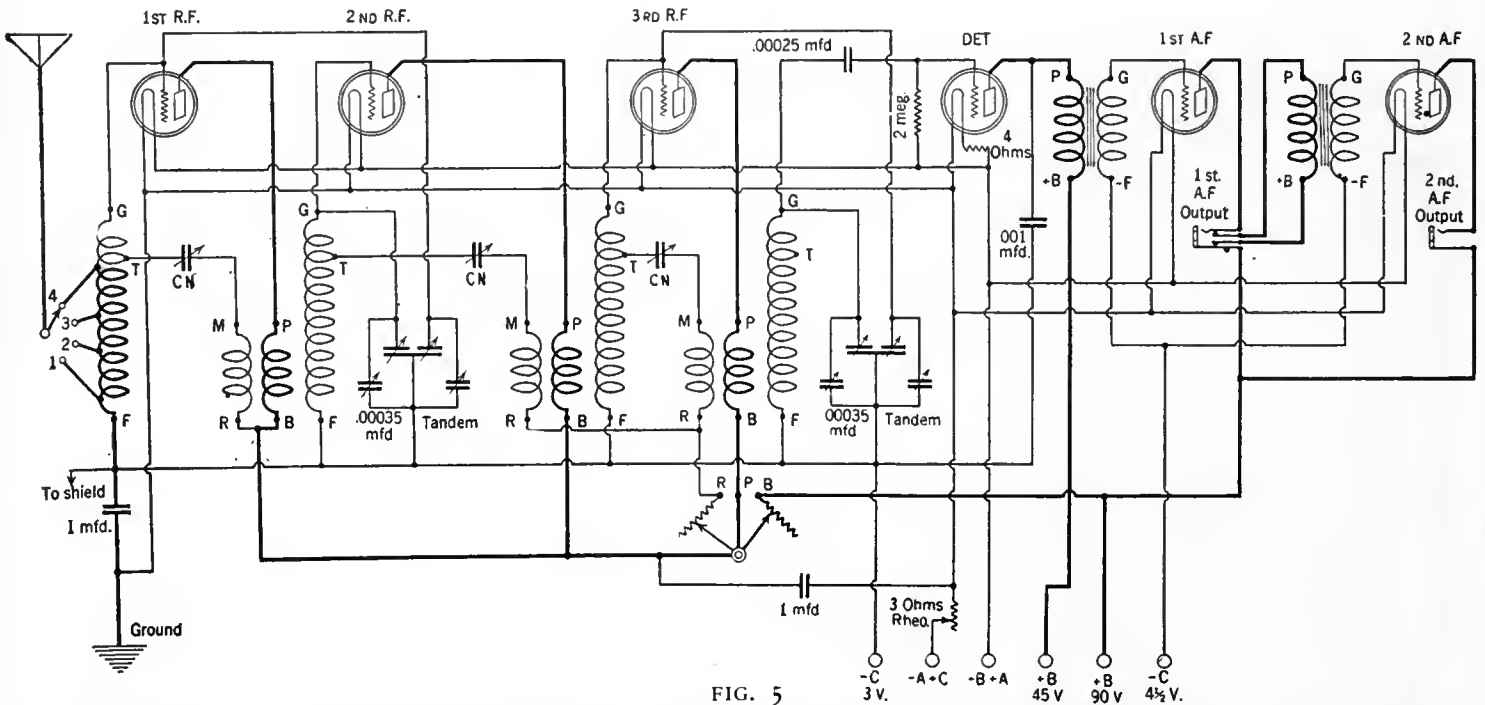

FIG. 5

In the "Counterphase" circuit shown here, the tendency of the radio frequency stages to oscillate is prevented by the separate circuits comprising the inductances M-R and the condensers C<sub>n</sub>. It is necessary to adjust the condensers C<sub>n</sub>, the variable part of this circuit, to suit the tube employed. On the high frequency end of the tuning scale, the tendency of a circuit to oscillate is greater than at the other end of the scale, the lower frequencies, so a panel adjustment is provided in the dual resistance control to compensate for these changes, thereby obtaining maximum efficiency on all frequencies within the tuning range





*“These Eveready Batteries are the correct size for your set. With average use they will last you a year or longer”*



“You have been one of the many who use ‘B’ batteries that are too small in capacity for their receivers. That is not economical. It makes you buy ‘B’ batteries twice as often as necessary. Fit the right size Evereadys to your set and add a ‘C’ battery,\* if you haven’t one, and you’ll get the maximum of service at the minimum of cost.”

The life of your Eveready “B” Battery depends on its capacity in relation to your set and how much you listen in. We know, through a careful investigation, that the average year-round use of a set is two hours a day. Taking that average we have proved over

\*NOTE: In addition to the increased life which an Eveready “C” Battery gives to your “B” batteries, it will add a quality of reception unobtainable without it.

and over that on sets of one to three tubes the No. 772 Eveready “B” Battery used with a “C” battery will last a year or longer. On sets of four and five tubes, the larger heavy duty Eveready batteries used with a “C” battery will last eight months or more.

The secret of “B” battery satisfaction and economy is: *With sets of from 1 to 3 tubes, use Eveready No. 772.*

*With sets of 4 or more tubes, use either of the heavy duty batteries, No. 770 or the even longer-lived Eveready Layerbilt No. 486.*

We have prepared for your individual use a new booklet, “Choosing and Using the Right Radio Batteries,” which we will be glad to send you upon request. This booklet also tells about the proper battery equipment for use with the new power tubes.

*Manufactured and guaranteed by*

**NATIONAL CARBON CO., INC.**  
New York San Francisco

Canadian National Carbon Co., Limited  
Toronto, Ontario



**LEFT—Eveready Layerbilt “B” Battery, No. 486, 4.5 volts, for maximum economy on four, five or more tubes.**



**RIGHT—Eveready DryCell Radio “A” Battery, 1½ volts. The battery built especially for dry cell tubes.**

# EVEREADY

## Radio Batteries

—they last longer

**EVEREADY HOUR**  
EVERY TUESDAY AT 9 P. M.  
*Eastern Standard Time*

For real radio enjoyment tune in the “Eveready Group.” Broadcast through stations—

- |                 |                            |                 |
|-----------------|----------------------------|-----------------|
| WEAF—New York   | WFI—Philadelphia           | WSAI—Cincinnati |
| WJAR—Providence | WGR—Buffalo                | WWJ—Detroit     |
| WEEI—Boston     | WCAR—Pittsburgh            | WOC—Davenport   |
| WTAC—Worcester  | wcco—Minneapolis, St. Paul | KSD—St. Louis   |

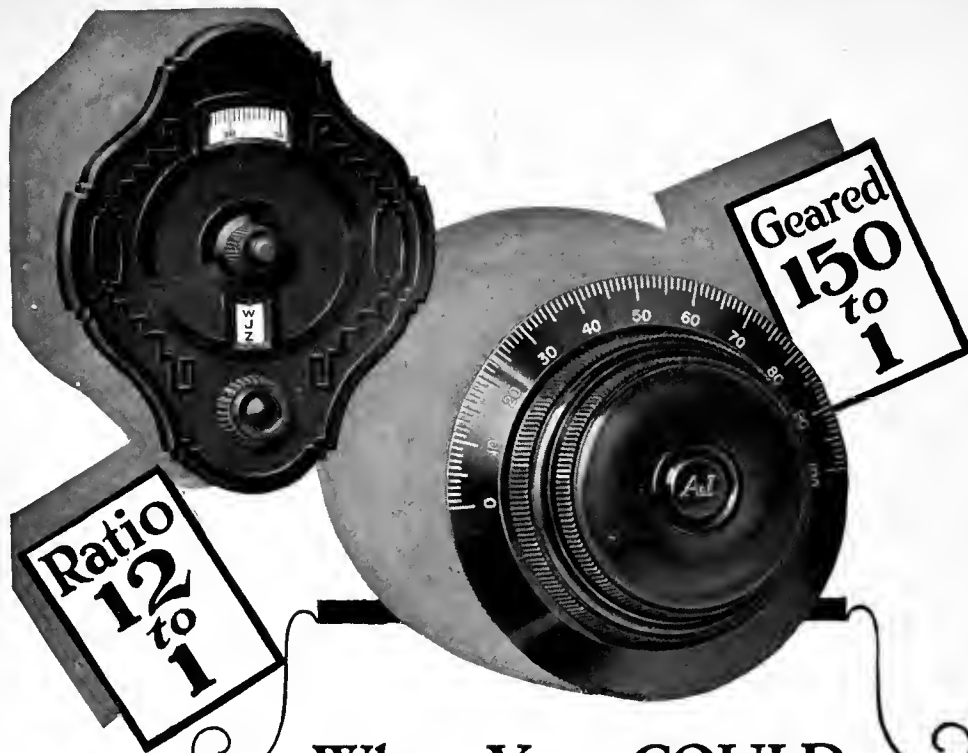

## What You COULD Get From Your Set

**I**T isn't what you're getting now. It's how much more you *could* get from your *present* set.

Your set may be one of the finest in the world but it can be no better than its Dials.

The human hand cannot tune ordinary dials sufficiently accurate to bring in all the stations within scope of your set. That's where Science has stepped in with the two dials shown above.

MYDAR Recording Dial shown at the left above, offers a degree of tuning efficiency not usually associated with this price. Ample space for call letters insures permanent logging of all stations. Genuine Bakelite, handsomely embellished—12 to 1 Ratio. Price \$1.75.

The A.J. (Vernier) shown at the right above, geared at 150 to 1, brings tones into sharp focus like a fine camera lens. Beautiful, dignified. Genuine Bakelite. A master product of master craftsmen—Price \$2.25.

Accuratune (not shown) geared 80 to 1 is admirably suited to every type of tuning requirements.

*No panel drilling necessary to substitute any one of these dials.*

★ **MYDAR Radio Company**  
3 CAMPBELL STREET  
NEWARK, N. J.

of a coil, and this is another method that has been used and probably will be again.

It is evident also that if one circuit were slightly detuned, the tendency toward oscillation would be reduced. Another method has likewise been employed, oscillations being prevented by reducing the plate load or number of turns in the primary circuit of the transformer, which cuts down the coupling between primary and secondary.

This latter method increases selectivity, but unfortunately the energy transfer between tubes is thereby reduced, and if the coupling is cut down sufficiently to prevent oscillation on the higher frequencies (shorter wavelengths), this same insufficient coupling results in very unsatisfactory response on the longer waves.

### CAUSE OF TROUBLE ON SHORTER WAVES

**A**T 550 meters, the upper end of the present broadcasting band, the frequency per second is only 545,100, but at 200 meters, or the lower limit, the frequency per second reaches the enormous number of 1,500,000 cycles. The resultant increase in tendency to oscillate on the higher frequencies (shorter wavelengths) has worried circuit designers from the earliest days of radio. It creates the problem that has been fought over, avoided, evaded, neglected, or ignored, according to the varying degrees of intelligence or intention involved.

Regardless, however, of what last year's arguments may have been, it is now quite generally agreed that when primary to secondary coupling is reduced to the extent that oscillation is prevented, the set will be satisfactory on the higher frequencies (shorter wavelengths) only. Within a narrow broadcast range 750 kc. wide (200 to 400 meters), such a set would be acceptable, but from 1500 kc. (200 meters) to 545 kc. (550 meters) gives a band 955 kc. wide,—greater than has been handled with satisfaction.

Some difficulty was avoided by the manufacture of sets and parts which would not reach the higher frequencies (shorter wavelengths), but this did not solve the problem for the user. When there were no stations assigned at the lower frequency end, the omission was not generally noticed, although undoubtedly part of the reason why stations were not assigned to this band was because of the trouble the Government knew would have ensued, and because of the complaints that would have arisen among those whose sets would not receive satisfactorily the full range in effect at the time they were made.

### SYSTEMS OF NEUTRALIZATION

**S**INCE the reduction of coupling to the point of complete avoidance of oscillation gives acceptable results over part of the range, it follows that increasing the coupling somewhat by a few more primary turns will bring the point of complete suppression farther up the wavelength scale, and while oscillations will occur below that point, the middle range will respond favorably, and the upper range to a slight extent.

Similar results are obtainable under the other methods mentioned by varying the amount of resistance or losses, or by fixed



## When a Finer Transformer Is Made It Will Bear This Name-Plate

Radio moves rapidly. Perhaps some time there may be seen a *better* transformer than what we *now* know as Rauland-Lyric. It may sell at \$9, or \$10, or \$15, or \$7. But the careful observer of the past year's developments will entertain not a moment's doubt of one thing: when the better transformer comes it will come beneath the famous Rauland-Lyric name-plate. Behind this as a pledge rests the entire organization and resources of the All-American Radio Corporation

Rauland-Lyric is easily obtainable from better-class dealers everywhere. The price is nine dollars. Descriptive circular with technical data may be had on request to All-American Radio Corporation, 4201 Belmont Avenue, Chicago

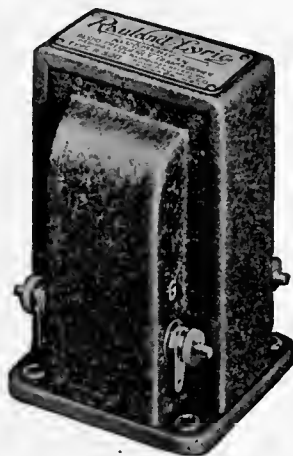

Rauland-Lyric tone quality is now available in a complete receiver: the new All-American Model R (a five-tube tuned-radio-frequency set) now being shown. If your preferred dealer does not display it, send to us for descriptive booklet



## What You COULD Get From Your Set

**I**T isn't what you're getting now. It's how much more you *could* get from your *present* set.

Your set may be one of the finest in the world but it can be no better than its Dials.

The human hand cannot tune ordinary dials sufficiently accurate to bring in all the stations within scope of your set. That's where Science has stepped in with the two dials shown above.

MYDAR Recording Dial shown at the left above, offers a degree of tuning efficiency not usually associated with this price. Ample space for call letters insures permanent logging of all stations. Genuine Bakelite, handsomely embellished—12 to 1 Ratio. Price \$1.75.

The A.J. (Vernier) shown at the right above, geared at 150 to 1, brings tones into sharp focus like a fine camera lens. Beautiful, dignified. Genuine Bakelite. A master product of master craftsmen—Price \$2.25.

Accuratune (not shown) geared 80 to 1 is admirably suited to every type of tuning requirements.

*No panel drilling necessary to substitute any one of these dials.*

★ **MYDAR Radio Company**  
3 CAMPBELL STREET  
NEWARK, N. J.

of a coil, and this is another method that has been used and probably will be again.

It is evident also that if one circuit were slightly detuned, the tendency toward oscillation would be reduced. Another method has likewise been employed, oscillations being prevented by reducing the plate load or number of turns in the primary circuit of the transformer, which cuts down the coupling between primary and secondary.

This latter method increases selectivity, but unfortunately the energy transfer between tubes is thereby reduced, and if the coupling is cut down sufficiently to prevent oscillation on the higher frequencies (shorter wavelengths), this same insufficient coupling results in very unsatisfactory response on the longer waves.

### CAUSE OF TROUBLE ON SHORTER WAVES

**A**T 550 meters, the upper end of the present broadcasting band, the frequency per second is only 545,100, but at 200 meters, or the lower limit, the frequency per second reaches the enormous number of 1,500,000 cycles. The resultant increase in tendency to oscillate on the higher frequencies (shorter wavelengths) has worried circuit designers from the earliest days of radio. It creates the problem that has been fought over, avoided, evaded, neglected, or ignored, according to the varying degrees of intelligence or intention involved.

Regardless, however, of what last year's arguments may have been, it is now quite generally agreed that when primary to secondary coupling is reduced to the extent that oscillation is prevented, the set will be satisfactory on the higher frequencies (shorter wavelengths) only. Within a narrow broadcast range 750 kc. wide (200 to 400 meters), such a set would be acceptable, but from 1500 kc. (200 meters) to 545 kc. (550 meters) gives a band 955 kc. wide,—greater than has been handled with satisfaction.

Some difficulty was avoided by the manufacture of sets and parts which would not reach the higher frequencies (shorter wavelengths), but this did not solve the problem for the user. When there were no stations assigned at the lower frequency end, the omission was not generally noticed, although undoubtedly part of the reason why stations were not assigned to this band was because of the trouble the Government knew would have ensued, and because of the complaints that would have arisen among those whose sets would not receive satisfactorily the full range in effect at the time they were made.

### SYSTEMS OF NEUTRALIZATION

**S**INCE the reduction of coupling to the point of complete avoidance of oscillation gives acceptable results over part of the range, it follows that increasing the coupling somewhat by a few more primary turns will bring the point of complete suppression farther up the wavelength scale, and while oscillations will occur below that point, the middle range will respond favorably, and the upper range to a slight extent.

Similar results are obtainable under the other methods mentioned by varying the amount of resistance or losses, or by fixed



## When a Finer Transformer Is Made It Will Bear This Name-Plate

Radio moves rapidly. Perhaps some time there may be seen a *better* transformer than what we *now* know as Rauland-Lyric. It may sell at \$9, or \$10, or \$15, or \$7. But the careful observer of the past year's developments will entertain not a moment's doubt of one thing: when the better transformer comes it will come beneath the famous Rauland-Lyric name-plate. Behind this as a pledge rests the entire organization and resources of the All-American Radio Corporation

Rauland-Lyric is easily obtainable from better-class dealers everywhere. The price is nine dollars. Descriptive circular with technical data may be had on request to All-American Radio Corporation, 4201 Belmont Avenue, Chicago

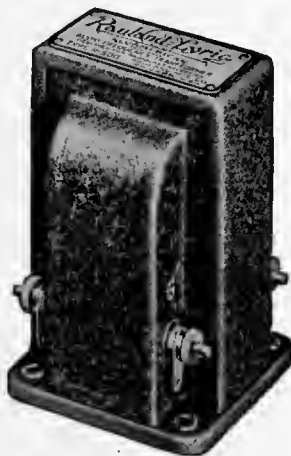

Rauland-Lyric tone quality is now available in a complete receiver: the new All-American Model R (a five-tube tuned-radio-frequency set) now being shown. If your preferred dealer does not display it, send to us for descriptive booklet

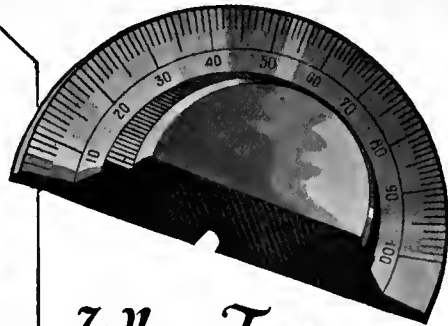
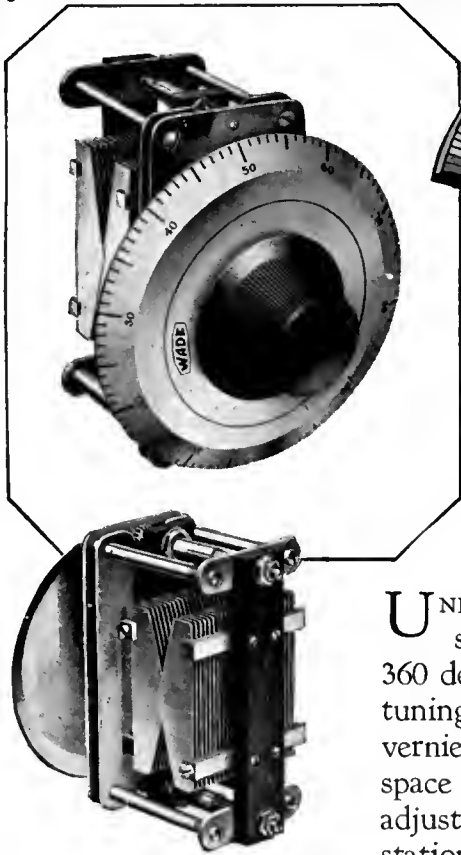

## Why Tune With Only Half a Dial?

UNIQUE design of Wade Condensers spreads stations over our entire 360 degree dial. The Wade is a complete tuning unit built with specially designed vernier dial. This means twice as much space between stations for close tuning adjustment; even wider separation of stations than the rotor plate types of straight line frequency condensers using standard 180 degree dials. None of the annoyance of overlapping stations and jumbled reception. The Wade Condenser gives the lowest minimum capacity and wider tuning range. Covers the whole broadcast range and down below 200 meters.

### Wade Tuning Unit Including Condenser and Dial

The Wade Tuning Unit consists of a Wade Condenser geared to a four-inch 360 degree vernier dial of 16 to 1 ratio. Finest possible control with no backlash. Prices below are for the complete unit.

Capacity .000125 mfd.	\$6.00
Capacity .00025 mfd.	6.25
Capacity .00035 mfd.	6.35
Capacity .0005 mfd.	6.50



### No Body Capacity Effects

A separately grounded frame insulated from both sets of plates shields the condenser from all body capacity effects—an important feature, exclusively in Wade Condensers.

Viking Tool and Machine Co.

745-A 65th Street, Brooklyn, N. Y.

# WADE

### Have your favorite circuit Built or Repaired by experts

We are recommended by  
Hammarlund-Roberts  
Radio Broadcast Aristocrat  
Sampson  
Browning-Drake  
Bremmer-Tully

To render this service  
These kits always in stock  
— Prompt Mail Order Service —

★  
Radio Construction Laboratories  
71-73 West Broadway New York City

### Books by Telegraph

between

New York

Cleveland

Kansas City

Springfield

Toledo

St. Louis

Doubleday, Page Book Shop

neutralization on some wavelength below the mid-scale, but none of these methods give results over the entire scale. Should the wavelength be increased by dropping the lower limit, there is still less possibility of satisfactory operation.

### EXTERNAL CIRCUIT REQUIRED

EVIDENTLY some other arrangement must be found to compensate for the inherent feedback of the present-day tube. A logical solution is an external circuit designed to feed back energy of opposite potential in such manner and amount as to overcome or neutralize the regenerative action of the tube. It must also be efficient over the entire tuning range of the receiver to which it is applied.

It is also evident that the adjustment of this external circuit should not remain constant for all broadcast frequencies. The sensitivity of a receiver is always greatest just below the point of oscillation of both r. f. and detector tubes. The action of a sensitive r. f. amplifier is therefore very similar to the regenerative circuit in which a regenerative control, or tickler, is always used to bring regeneration up to the point of oscillation. The difference is that, in a radio-frequency amplifier, this action is reduced below the point of oscillation.

Panel control of sensitivity is just as important and desirable, for example, as the panel control of a tickler in the well-known three-circuit regenerative receiver. Permanent neutralization, on the other hand, is to all practical purposes similar to what we would find with a permanent adjustment of the tickler in the circuit mentioned.

Only recently a new method of controlling oscillation has been brought forward by the Bremer-Tully Company of Chicago, and has been secured by patent. This system has been termed the "Counterphase," and an explanation of its function is of interest.

The Bremer-Tully "Counterphase" circuit includes a bridge between the output and the input circuits. Counter potential is derived from a coil coupled inductively to the plate circuit, and fed, through an adjustable capacity, to a coil inductively coupled to the grid circuit. Any connection made between plate and grid circuits must to some extent increase grid-to-plate capacity, which in turn tends to increase oscillation. The most careful design is necessary, therefore, to avoid such increase as to make neutralization impossible in any neutralizing circuit at the high frequencies (shorter wavelengths) of the broadcasting range. In the Bremer-Tully "Counterphase" method, this capacity effect is overcome to such an extent that neutralization on as high frequencies as 1500 kc. (200 meters) is easily accomplished.

As compared to any fixed method of neutralization, it will be noted that the link circuit between each r. f. stage includes a small adjustable condenser. The method of controlling two or more stages of r. f. amplification is extremely simple.

The circuit is shown in Fig. 5.

It is well known that the variation of a resistance in series with a condenser varies the effective capacity of the condenser.



### Blackburn Ground Clamps

★  
Telephone companies using MILLIONS. Adjustable—fits any size pipe. Requires no pipe cleaning—screw bores through rust and scale. Send 12 cents for sample and postage.

Blackburn Specialty Company  
1960 E. 66th St. Cleveland, O.

# DIS-TON



Employs no fluids of any kind. Uses only one rectifying tube. Separate adjustment for detector and amplifier tubes. Handsomely finished in rich velvet-green Duco with solid walnut, satin finish top and bottom. Ample continuous "B" current for one to ten-tube sets.

## Give your Radio Set a "B" Current Supply—*for life!* ★

DIS-TON, using alternating current from your lamp socket, in place of "B" Batteries, is guaranteed to improve the overall efficiency of your set. It provides constant "B" current at proper potential for your receiver circuit, tubes and loud speaker.\* DIS-TON is noiseless in operation—no crackles and popping such as you get with run down "B" Batteries—no hum of any kind to distort the finest aria or drown out the faint signals from distant stations.

### Remarkable Clarity—Amazing Volume and Selectivity

DIS-TON is trouble free—the special Trans-Filter Unit is sealed in, protected against tampering and deterioration. It can't wear out. Consumes only eight watts from the nearest lamp socket and puts your "B" load on the big, powerful, carefully watched generators of your central station. You can rely upon DIS-TON to give you the best from your receiver.

Without attention of any kind after simple initial adjustment to your set—DIS-TON insures you the equivalent in performance of new "B" Batteries every time you listen in.

DIS-TON requires no change in the internal wiring of your set to secure either utmost efficiency or entire safety. Accidental improper connections can't result in tube "burn outs."

DIS-TON complete  
ready for operation  
110 volt, 60 cycle  
\$40.00  
Special 3 Voltage  
DIS-TON, 60 cycle  
110 volt, \$45.00  
Other voltages and  
cycles on application

### Know how much DIS-TON adds to radio

The advantages that DIS-TON will give you are outstanding and unusual. You have the opportunity to verify them all on your present receiver. A DIS-TON demonstration is yours for the asking. Send for Leaflet B and full details as the first step to greater radio enjoyment this season.

DIS-TON KITS  
Essential Parts  
for  
Home Builders  
110 volt, 60 cycle  
\$28.50  
Other voltages and  
cycles on application

## RADIO PRODUCTS, Inc.

Dept. RB

Richmond, Ind.

\*Regular DIS-TON will modernize the performance of any of the good, older receivers in an amazing fashion. Three voltage DIS-TON is the only AC current supply adapted to the newest circuit where different detector, radio frequency and audio frequency "B" potential is required.



# TONE

*clear—natural—pleasing—musical*

**T**HE latest Bristol refinement, the Super-Unit, contains a large, low-pitch diaphragm which brings in, not only the middle and upper registers, but all those deep bass notes heretofore only imperfectly heard if at all. With a Bristol, either Super S or Super C, you hear *all* the concert; with it *all* tones are distinguished in their proper qualities, in all selections.

**Have Your Dealer Send One Out On Christmas Eve**

He will be glad to have you try any one of the Bristol models in your home. It's an ideal way to appreciate Bristol tone quality and judge for yourself. There are four Bristol Speakers: Super S at \$25.00, Super C, the Cabinet, at \$30.00 and horn types at \$15.00 and \$20.00.

**Send for Booklet "How to Select Your Loud Speaker"**

Easily understood and explains the "how" and "why" of mechanisms and materials in loud speaker construction.

## BRISTOL SPEAKER

[The AUDIOPHONE]

THE BRISTOL COMPANY

Radio Div. AH

WATERBURY, CONN.

*for 36 years makers of the highly sensitive and accurate Bristol's  
Recording Instruments.*

**SUPER S \$25.00**

Rubber horn 14 $\frac{1}{2}$ " diameter. Black mat finish. Gold decorated base. Equipped with new Super-Unit.

Therefore, by placing one resistance in series with and common to all the neutralizing circuits, the capacity of each can be changed by varying this common resistance.

The effect is to unbalance these circuits, permitting an increased sensitivity, easily variable over all frequencies within the range covered.

Here again we find a fortunate factor operating in our favor. Aside from the advantage of enabling us to control several stages with one knob, this resistance does not introduce losses or interfere with selectivity, and in addition to that it does not affect dial readings by detuning the circuit.

### DUAL RESISTANCE-CONTROL AN ASSET

**I**NASMUCH as sensitivity is not required on stations where it is desirable to reduce volume, the same knob can be used to operate a separate resistance in the B battery circuit to control volume.

This is accomplished by a dual resistance containing two distinct resistance elements, each operable over an arc of 240 degrees.

When sensitivity is the objective, no reduction in volume is desired. When a decrease in volume is wanted, there is no demand for sensitivity. Therefore, in operation, it is necessary only to turn one knob to the right or left to secure either one or the other as desired.

In addition to the simultaneous unbalancing feature which makes it possible to secure sensitivity over the full range, the "Counterphase" method makes it possible to control three stages of tuned radio frequency efficiently with but two tuning controls.

In design the circuit is distinctly new and will no doubt appeal to those who are of that jaded group of circuit seekers and dyed-in-the-wool experimenters who are always on the look-out for "something new under the sun."

### VALUES OF PARTS EMPLOYED IN CIRCUIT

**T**HE coils employed in the "Counterphase" circuit are toroids, each wound on a frame 1 $\frac{5}{8}$ -inches square. The secondary consists of 168 turns of No. 24 double silk covered wire and is tapped at the 124th turn from the filament end. It has an inductance value of 220 millihenries. The primary is spaced inside the secondary at the filament end, and consists of 52 turns of No. 36 d.c.c. or d.s.c. wire.

The "Counterphase" coil is wound with 96 turns of the No. 36 wire, its turns being spaced between the turns of the primary. The antenna secondary is tapped at the 2nd, 8th, 25th, and 40th turn from the filament end of the coil. The tuning condensers are .00035 mfd; the trimmers .000024 mfd. The "Counterphase" condensers  $C_a$  have a minimum of 1 mmf. and a maximum of 30 mmf.

The dual resistances are variable, the one located in the counterphase part of the circuit is 3000 ohms and that in the plate circuit 500,000 ohms.

The by-pass condensers are as follows:— A .001-mfd. across the first audio transformer primary; a 1-mfd. across the C battery, and a 1-mfd. across the B battery.





## If You Seek Economy, Buy the Best!

By HAROLD JOLLIFFE

*The time has come, the Walrus said,  
To talk of many things;  
Of shoes and ships and sealing-wax,  
Of cabbages and kings.*

—CARROLL.

THE fellow who came out with that clever remark about economy, certainly was a wise old bird; his head was in the right place, and he knew what he was talking about. We do not know who the originator of this bright little maxim was; he probably dates 'way back down the dim corridors of time to the obscure and misty past, when the ancient Phoenicians dauntlessly set forth in their little vessels to invade the shores of distant Britain with their varied trade. Quite likely it had its inception at a far earlier date than that; maybe it was around about the time when that little fellow, David, got peeved and knocked his enemy, the great and husky Goliath, for a home run, with a well-directed stone from his sling.

But no matter when, where, or how. It is an axiom that applies now as ever; and it holds just as forcefully in radio as in anything else under the sun. You can't get away from it.

Take vacuum tubes, for instance. As everyone knows, for the standard price of two and a half dollars you can walk into any radio dealers' and purchase a good tube; a tube of recognized quality; a tube which is the result of the constant efforts of many of the greatest scientists of the age, and years and years of tireless study and ceaseless experiment. Millions and millions of dollars have been expended to bring it up to its present high state of perfection, and it has embodied in its construction all those desirable and necessary qualities which make for an efficient, serviceable tube. It is rated at a certain voltage and current consumption, and is guaranteed to perform exactly as indicated by the manufacturer when his directions, regarding its use and care, have been followed carefully, and provided it is not abused. Therefore, such a tube may be expected to do all that is claimed for it.

And yet, there are those who will waste one dollar—yes, one buck's the price! Can you beat it?—on a tube which, in the first place, is probably a "second" of a so-called independent manufacturer; a tube which, if rated as consuming .25 amps., will more than likely draw considerably in excess of that amount; a tube which may not even fit its socket, for that is exactly the case with some of the three-volt variety. You have to take a file and rub down what appears to be a small brass rivet projecting from one side of the base, before it can be inserted into a socket; others sit wobbly in their sockets because their bases have a diameter of one-sixteenth inch less than the internal diameter of the shell of the socket, which results in uncertain contact.

The writer knows of a case where an elderly couple had a four-tube receiver, and the tubes, having become worn out through continued use, needed replacement. Despite warning, they bought four tubes of the above-mentioned type, and without a word of exaggeration, these tubes gave absolutely no satisfaction. They ate very heavily into the dry A batteries—the tubes were of the three-volt class—and produced a most annoying whining sound which could not be eliminated and which was not due to any fault of the receiver, which was pulled apart and re-wired in an attempt to locate the trouble. In the end, they had either to buy four good tubes or let the receiver sit on the table and collect dust. Being devout fans they purchased the tubes, and presto!—the set worked like a charm.

It therefore cost them sixteen dollars to replace the tubes instead of twelve. But they were attracted by the low price. False economy! They might just as well have thrown the cheap tubes into the ash can.

What is the good of buying such tubes and taking a chance as to whether they will be any good? Admittedly, you will strike some good ones now and again, but at the most, they are good for but a fraction of the service you would get from the better class.

The writer, with the help of a certain dealer, tested several of these tubes with a device which registers the current in the plate circuit when the filament is heated to a certain temperature. If a recognized make of 201-A tube was inserted in the socket, and the customary five volts applied to the filament, the milliammeter indicated a current of anywhere between 1.1 to 1.4 milliamps. But if one of the dollar variety were tried, it was seldom indeed that a reading of more than one milliamp. was obtained; many went as low as .75 milliamps., but only once in a while would the meter indicate a good tube.

Then again many of them will not oscillate. The writer has three such tubes of the 201-A type which were loaned him for testing purposes. One will oscillate very strongly if a pressure of no less than 5.5 volts is applied to the filament. The remaining two will not oscillate at all, which, of course, renders them useless as detectors in a regenerative circuit. And do they play havoc with the A battery! I'll tell the world!

AND TRANSFORMERS!

CONSIDER audio frequency transformers. These, next to vacuum tubes, are probably the most delicate of all radio receiving apparatus. They must be designed and constructed with the greatest thought and care, for it is upon the design and construction of the audio amplifier that the quality of the received music depends. Oh, yes; the loud speaker does have a lot to do with it, but the audio amplifier first. Now, if there is anyone who believes it possible to produce a good transformer, one that will really do the work, for \$1.50, let him take the floor and show us how! It simply can't be done, after the middlemen have taken their profits.

Yet, a rather doubtful looking affair can now be purchased at that price at certain cut rate stores—one dollar for the winding and fifty cents for the core, is the way they advertise them.

A socket for twenty-five cents, and not such a bad-looking affair at that. Cheap? Sure it is, until you apply the soldering iron and melt half of it. Nothing but "mud"!

Radio fans! If you wish to build a good receiver, one that will reward you with the greatest possible clarity and distance for a given number of tubes, one that will be easy to work with during construction, one that you can pull apart without damaging the apparatus when you wish to switch over to another circuit—then purchase, steal, or otherwise acquire good, dependable apparatus. There's a reason!

Take the case of John Brown, for instance. The radio bug bit Johnny good and hard; so having a nice little work bench and all the necessary tools down the cellar, he decided to "roll his own." Being a sensible sort of a fellow, he went out and bought the best he could afford, and since he didn't know much about it, he took someone along with him to show him what was what, and why. Johnny now has a fine outfit if there ever was one, a real low loss set, and he is justly proud of it. He gets splendid results; night after night the old stations come pounding in with a roar; and Johnny sits back in the old easy chair with a contented look on his face, and enjoys real radio satisfaction.

His neighbor, just a few doors down, is always tinkering around, fixing this and changing that and wondering why in heck his set won't work as well as Johnny's. The answer is simple. Although he could afford it, he wouldn't spend the necessary cash to buy the good parts that characterized Johnny's purchase. Disregarding the reliable dealer down at the corner, he went to the other store where "a real low loss" variable condenser sells for a dollar and a quarter, and bought a lot of cheap stuff that Johnny and his experienced friend passed up with a grin of derision. He now has more sense, and is thinking of junking the entirety of his original purchase and starting in all over again with good apparatus.

Johnny Brown doesn't have to do that, so he is just that much money to the good.

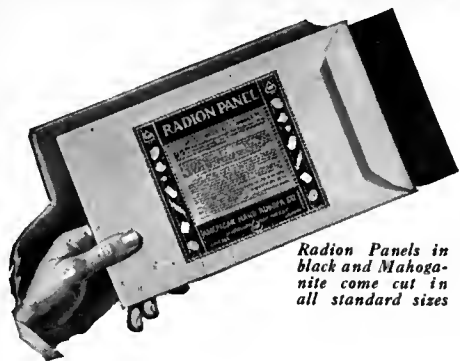

Radion Panels in black and Mahogany come cut in all standard sizes

## The double advantage of RADION

SUCCESSFUL set manufacturers and experienced amateurs know that there are two important requirements for any set:

1. Efficient reception.
2. Good appearance.

The selection of RADION goes far toward fulfilling both these requirements. RADION Panels possess superior insulating qualities not equaled in any other panel made. And RADION has such a beautiful surface finish that it noticeably enhances the appearance of any set.

New No. 10 4-inch Radion Dial, built to conform to the fingers, helping you to get close tuning.



This double advantage of RADION is due to the fact that it is the *only insulation that was made to order for radio purposes exclusively.*

The high-resistant characteristics of RADION Panels mark all RADION low-loss parts—Sockets, Dials, Insulators, Tubing, etc. Adopted by leading manufacturers and sold universally by radio dealers.

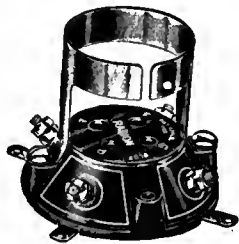

No. 2 Radion Socket for new UX tubes with collar adapter for old type tubes. No. 4 same as No. 2, without collar adapter for new UX tubes exclusively.

Send for booklet, "Building Your Own Set." Mailed for 10 cents

Manufacturers: Our facilities and equipment for the manufacture of moulded parts are second to none. Write us for prices on quantities.

AMERICAN HARD RUBBER COMPANY  
Dept. C-13 11 Mercer Street New York City

Chicago Office: Conway Building  
Pacific Coast Agent: Goodyear Rubber Co.  
San Francisco Portland

# RADION

The Supreme Insulation

Made to order for radio purposes exclusively

*Powel Crosley, Junior  
has always done  
the Unexpected.*

*His Announcement  
December 26th  
will be no exception  
to that Rule.*

ASK . . ANY . . RADIO . . ENGINEER

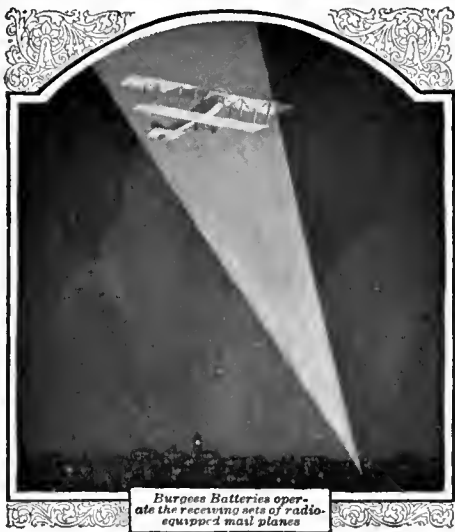

Burgess Batteries operate the receiving sets of radio-equipped mail planes

## An every-night adventure of Burgess Radio Batteries

ONE of the reasons why you should always buy Burgess Radio Batteries is that the batteries used by air-mail pilots—battleships—explorers—and the majority of recognized radio engineers—are evolved in the Burgess Laboratories and manufactured in the Burgess factory.

These batteries are identical with the batteries sold by your dealer and thousands of other good dealers everywhere.

**BURGESS BATTERY COMPANY**  
 GENERAL SALES OFFICE: CHICAGO  
 Canadian Factories and Offices:  
 Niagara Falls and Winnipeg

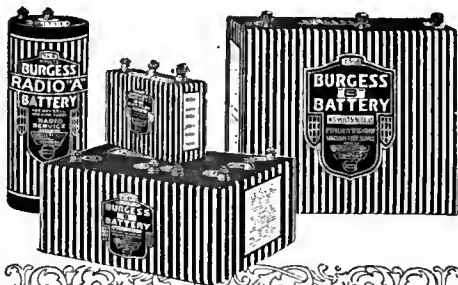

# “NOW, I HAVE FOUND . . .”

A Department for the Exchange of Ideas and Suggestions of Value to the Radio Constructor and Operator

CONTRIBUTIONS to this department are welcome and those used will be paid for at the usual rates, that is from two to ten dollars each. A prize of twenty-five dollars is given for the best idea used during each three-month period. The prizewinner for the last period was announced in the November RADIO BROADCAST. All manuscripts intended for this department should not exceed about three hundred words and should be typewritten. Little consideration can be given to manuscripts not typewritten. Envelopes should be addressed to this department, RADIO BROADCAST, Garden City, New York.

### THE ROBERTS CIRCUIT AND AUDIO AMPLIFIER WITHOUT A STORAGE BATTERY

THE circuit about to be explained consists of the well-known Roberts two-tube circuit plus one stage of audio amplification. One five-volt tube and two three-volt tubes are employed. The filament supply for the three-volt tubes consists of a battery of dry cells, while the five-volt audio amplifier tube is supplied through a transformer by the 60-cycle a. c. lighting system. In this way the expense and inconvenience of a storage battery are eliminated without sacrificing any of the good points of the set.

In order to eliminate the a. c. hum from the amplifier, a potentiometer and grid bias are necessary. By connecting the grid return of the amplifier to the negative ter-

value and the switch used for making and breaking the filament circuit.

A transformer with a secondary voltage of at least six, is used. This steps down the house lighting circuit voltage from 110 volts. A toy transformer is being used on my set at present. A bell ringing transformer which gives the required secondary voltage may be used. Do not burn the tube at greater brilliancy than is necessary to obtain good, clear tone quality.

The filament rheostats of the three-volt tubes are each of 25 ohms resistance. It is important that the negative terminal of the filament battery be grounded; otherwise a hum will be heard in the phones.

The adjustment of the amplifier consists merely in lighting all the tubes, plugging-in on the amplifier, and adjusting the potentiometer arm until the hum heard in the phones is at a minimum. The position of

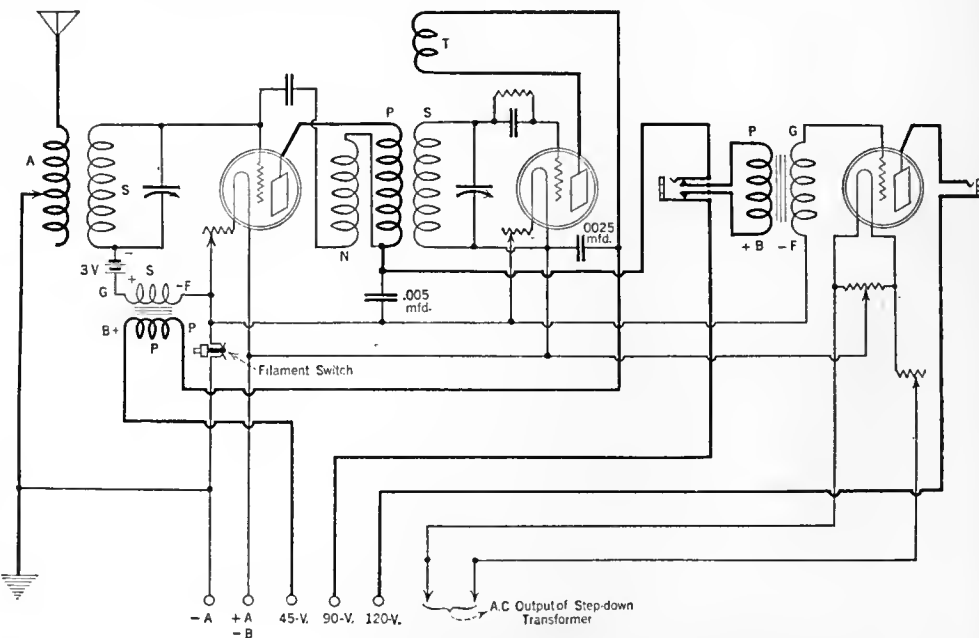

FIG. 1

terminal of the filament supply for the three-volt tubes, and connecting the potentiometer arm to the positive terminal of this battery, the grid of the amplifier acquires a  $4\frac{1}{2}$ -volt negative bias.

I have found by operation that a vernier is not necessary on the grid circuit tuning condenser of the first tube. However, on the second tube, a vernier condenser greatly facilitates tuning. Two jacks are so arranged that the loud speaker may be plugged-in on the output of the three-volt or on the amplifier output. A filament switch is used to control the filament circuits of the three-volters. In this manner the filament rheostats may be set at the proper

the arm should be midway between its extreme end positions. If the hum is not reduced to low audibility when the potentiometer arm is near its mid-position, check over the amplifier connections and examine the potentiometer itself for broken wire or loose contacts.

The circuit as shown in Fig. 1 is correct for two three-volt tubes and one audio amplifier tube. This latter tube may be of any type capable of handling the output of the preceding tubes. The ohmic value of its rheostat is determined by the filament current and voltage, and by the output voltage of the filament transformer.

For a tube requiring a filament current of

# NATIONAL Velvet Vernier DIAL

## Type B, Variable

(Patents Pending)

Positive Control  
Easily Mounted  
Gearless



Variable Ratio  
Velvety Smooth  
Graceful Design



With This NEW National Type B, Velvet Vernier Dial,  
*YOU* Control the Reduction Ratio!

**W**HAT a difference in the tuning of your set when you replace your plain dial with a new NATIONAL Type B Variable (patents pending). You'll be astonished.

Any ratio you desire, from a minimum of 6 to 1 to a maximum of 20 to 1 is instantly obtained by shifting a small lever. Note how it separates the stations operating on the lower wave lengths.

Easily mounted on the  $\frac{1}{4}$ " shaft of any standard type of variable condenser. The only tool you need is a screw driver.

The same velvety smoothness, the same freedom from backlash, the same mechanical drive as the famous Type A Velvet Vernier Dial, (patents pending). Price \$2.50.

## The NATIONAL Tuning Unit

for the popular circuits and hook-ups gives amazing results to amateur set-builders.

Comprises the NATIONAL CONDENSER and the wonderful BROWNING-DRAKE TRANSFORMER Complete in one package, Price \$22. Makes a most welcome Christmas Gift.

Write for Bulletin 106 R. B.

**NATIONAL CO., INC.**

W. A. READY, *President*

110 Brookline St. CAMBRIDGE, MASS.



NATIONAL Tuning Unit  
Type B D-2

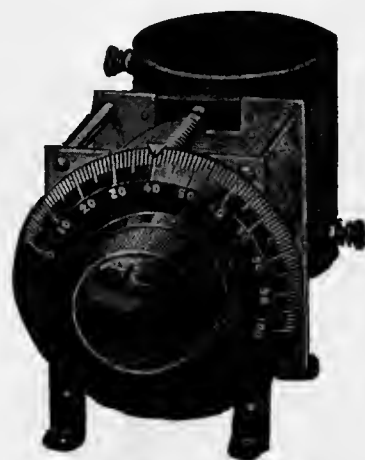

NATIONAL Tuning Unit  
Type B D-1

# Better Tone!

## with Dry Cells and UX 120

than with Storage Batteries

Note: The UX 120 is a new three-volt dry battery power tube. Used for audio frequency amplification, this tube will produce better quality and greater loud speaker volume than regular storage battery tubes.



Any set owner can easily install a UX 120 tube in his set in a few minutes by using the new Na-Ald Number 120 Connectorald. It is a simple, efficient means of introducing the necessary additional "B" and "C" voltage required for this tube into the plate and grid circuit *without rewiring the set*. As easy to use as an adapter.

Just slip the Connectorald onto the UX 120 tube and put the tube in the socket. Connect the batteries—and well, that's all there is to it. Except to enjoy a quality and volume you would not have believed possible. No need to fuss with charging batteries. The simplicity, economy and freedom from attention characteristic of dry cells is now combined with the real volume and quality previously obtainable only with storage battery tubes.

The No. 120 Connectorald is suitable for all sockets—metal neck as well as insulated. For sale at radio, electrical and hardware stores. Price, \$1.25.

### NA-ALD ADAPTERS



#### Na-Ald Adapter 419-X

With this adapter the Na-Ald de Luzze Socket will take the new UX 199 small base tube. Price, 419-X, 35 cents.

#### Na-Ald 420 Connectorald

No. 420, equipped with cables, enables owners of Radiola Super-Hel to get the great increase in volume and clarity the new UX-120 tube develops. Price, 420, \$1.25

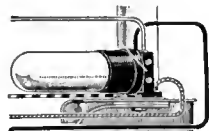

#### Na-Ald Adapter 421-X

No. 421-X makes possible the shift from WD-11 to UX tubes. Especially designed to enable owners of Radiola III, and III-A to enjoy the improved operation the new tubes provide. Price, 75 cents.

All Na-Ald products are for sale at radio, electrical and hardware stores, everywhere. Send for complete data on adapters for new tubes.

### ALDEN MANUFACTURING CO.

Also makers of the Famous Na-Ald Sockets and Dials

Dept. B14 Springfield, Mass.

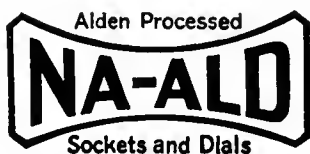

$\frac{1}{4}$  ampere, use a 6-ohm rheostat for a secondary voltage of 6 volts; use about a 25-ohm rheostat for any voltage between 6 and 10 volts.

For a tube requiring a filament current of one ampere, a 6-ohm rheostat may be used for any voltage up to 10 volts.

I have used plate voltages as low as 67 volts on both amplifier tubes with satisfaction. The optimum value of plate voltage for the detector tube can best be found by experiment, and for the three-volt tube will be about 40 volts.

JOHN B. CLOTHIER, JR.,  
Lansdowne, Pennsylvania.

### A HOME-MADE LOUD SPEAKER

THE main difficulty in loud speaker horn construction lies in cutting the parts to fit, and in obtaining well proportioned lines and acoustics, which will be a credit to the finished product.

A brief study of the patterns and details given below, will enable anyone to build easily a horn which will be very satisfactory with an audio-frequency amplifier.

It is constructed almost entirely of  $\frac{3}{16}$  inch fibre or cardboard, and the dimensions for the various pieces are outlined in Fig. 2.

The back, A, is cut from a piece 9 inches wide and 24 inches long. A line drawn through the center and perpendicular to the 9-inch side, will aid in making the nine measurements, one every three inches, to secure the curves indicated. The two sides, B, and back, C, are likewise laid out and cut with a sharp knife.

The four parts are fitted together by lapping A and C over the two sides, B, beginning at the bell end and taking one corner at a time and bending to conform to the curves and fastening, wherever necessary, with a few stitches of No. 26 copper wire, which is threaded through perforations near the edge.

After all corners are fastened, four strips of strong paper, 4 inches wide, are cut to fit each corner. These are creased lengthwise,



THE FINISHED SPEAKER

scored where bends cause wrinkles, and pasted on smoothly.

To assist in making the base, D, a circle 14 inches in diameter is drawn on a piece of cardboard. This is then marked, cut, scored on the dotted lines, bent over a sharp edge and the seven  $\frac{1}{2}$ -inch woodstrips tacked in at the corners. Four of these may be used if desired. A  $\frac{7}{8}$ -inch hole is cut in the center of the base for a No. 522 CW Western Electric Loud Speaker Unit. The base and horn are then fastened together with moulding and small brass screws, and the whole given four coats of paranite. Paranite can be made by dissolving parts of an old phonograph record in denatured alcohol. It strengthens the horn and gives it a very desirable velvet black finish.

The unit is fastened in the base by first inserting the rubber bushing to a tight fit.

(Continued on page 37A)

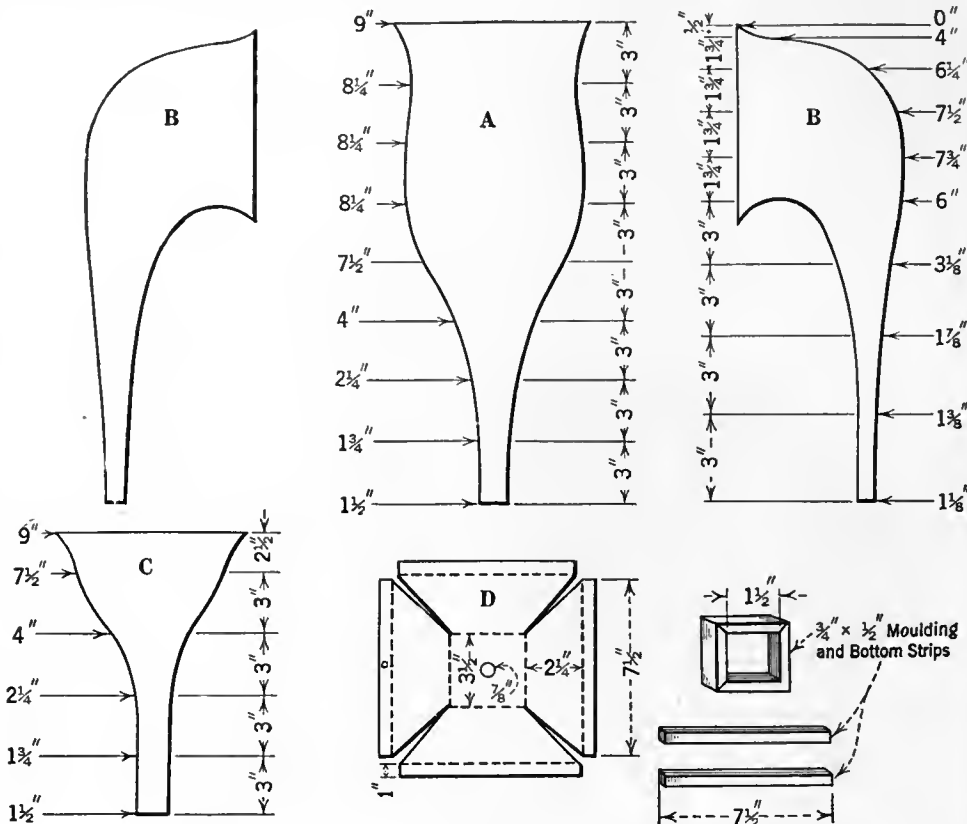

FIG. 2

**\$50. to \$250 a week  
IN WORK THAT IS  
ALMOST ROMANCE**

**Be a Radio Expert**

Get into the great new Big-Pay Industry—Radio. If you're earning a penny less than \$50 a week, **clip coupon now.** Send for **AMAZING FREE BOOK.** Be a Radio Expert and draw

down big money for the easiest and most fascinating work in the world. Positions everywhere. Thoroughly-trained men are in big demand. Need for Radio Experts in every community. Short hours. **BIG PAY. Free book gives all the facts.** Astonishing opportunities—thousands of them! Every day N. R. I. trained men are taking good places in the Radio field. Free book tells all about their success. Send for it now!



**Learn Quickly and Easily  
AT HOME**

Master Radio Engineers will show you how to qualify quickly and easily at home, for Radio's fine jobs. We **guarantee** to train you successfully. Lack of experience no drawback—common schooling all you need. Our tested, clear methods make it easy for you. Send coupon now for free proof.

**Instruments  
Given with Course**

All instruments shown here and many others given to students for practice work while learning. Receiving sets, from simplest kind to thousand mile receiver, an **UNEQUALLED OFFER.** Many other big features for limited time only.

**Famous  
Training That  
"Pays for Itself"**

Spare-time earnings are easy in Radio. Increase your income almost from the start through practical knowledge we give you. This is the famous **practical** training that **pays its own way.**



**Operates WMAQ**  
"Accepted a position with Chicago Daily News—Station WMAQ. My income practically doubled thanks to your fine course."  
KEITH KIMBALL, Chicago.



**Gets Big Job**  
"Just been made Sales Manager of this Radio concern—a big raise in pay. Regret I did not take course sooner."  
R. E. JONES, Bay City.

**Get  
this  
Amazing  
Book**

Most amazing book on Radio ever written—full, interesting facts about this great field and how we prepare you and help you start. You can do what others have done. **GET THIS BOOK.**

**SEND COUPON**

Send coupon to-day for special limited offer, including all instruments—you'll get full particulars by return mail.

**National Radio  
Institute**

Dept. AU5, Washington, D. C.

**You get  
all of  
these**

**RICH REWARDS IN RADIO**

**MAIL THIS NOW**

**NATIONAL RADIO INSTITUTE  
Dept. AU5  
Washington, D. C.**

Without obligating me in any way, send me your free book, "Rich Rewards in Radio," and all information about your practical, home-study Radio course.

Name .....

Address .....

Town.....State.....

**Radio  
Needs  
Trained  
Men**

**LARGEST RADIO SCHOOL IN THE WORLD**

**ORIGINATORS OF RADIO HOME-STUDY TRAINING**



No. 109

**ANOTHER JEWELL DEVELOPMENT—**

—Jewell

Engineers are constantly studying the latest developments in radio:—where there is need for a new instrument we are the first to design it.

**The Jewell No. 109 Super-Heterodyne Voltmeter**

—Shown above was designed for owners of Radiola portable Super-heterodyne sets. It is mounted in a panel which is an exact duplicate of those in the set.

**SAVE YOUR TUBES**

ASK FOR JEWELL 15-B RADIO CATALOG.

**Jewell Electrical Instrument Company**

1650 Walnut St., Chicago, Ill.

26 Years Making Good Instruments

The insertion of the nipple into this rubber under considerable force holds it permanently, while the cord is brought out through a small perforation in the side. The diaphragm of the unit is adjustable, and in conjunction with this horn and 90 volts on the plate of a two-stage amplifier, it brings in distant stations with as good definition and volume as many more expensive speakers.

J. T. GARVER,  
Huntington, Tennessee.

**CYLINDRICAL COILS FOR THE KNOCKOUT SET**

**T**HIS letter is in response to your request in RADIO BROADCAST regarding the use of cylindrical coils in the Roberts circuit. (Incidentally, I bought this particular issue at a newsstand in Singapore.)

I built a three-tube Roberts outfit last summer, using cylindrical coils, and consider it a very satisfactory set. I find that some distortion is present when receiving local or near-by stations, but on the DX stuff the reproduction is all that could be desired. The distortion on locals can be eliminated by slightly detuning the left hand condenser.

The circuit is shown in Fig. 3 while the arrangement of coils may also be seen in this diagram. Tubes of the UV-201A type,

daylight cut them off. It is interesting to note that all of the stations east of the Rockies suddenly fall off at about 3200 miles west of San Francisco, in longitude 173 East. The same effect is noticed on the 4200-3700 kilocycles-(75-80 meter) amateur signals which are very strong one night and unreadable the next as we go farther east. At the same time there is no decrease in the signal strength of the west coast stations.

I found that the use of No. 24 d.s.c. wire for the coils was satisfactory, and used this wire throughout. The dimensions of the coils and the data for their construction is perfectly simple, and is as follows: S-1 consists of forty-five turns wound in single-layer fashion, on a suitable tube of three-inch diameter; A, which is the primary coil, is next wound on the same tube and on top of S-1, in the center. It consists of 25 turns of the 24 d.s.c. wire, and is tapped at every fifth turn; N-P is the next consideration. It is formed of two 20-turn coils wound on top of each other, on a tube with a diameter of 2 5/8 inches; S-2 is bank wound, and is composed of 45 turns. Its cylindrical form is also 2 5/8 inches diameter; T, the tickler coil, is made by winding 20 turns on a 2-inch tube. The tickler coil is so arranged that it may be variably coupled to S-2, as shown by the dotted lines in Fig. 3. I have found this arrangement gives better results than if the tickler is mounted

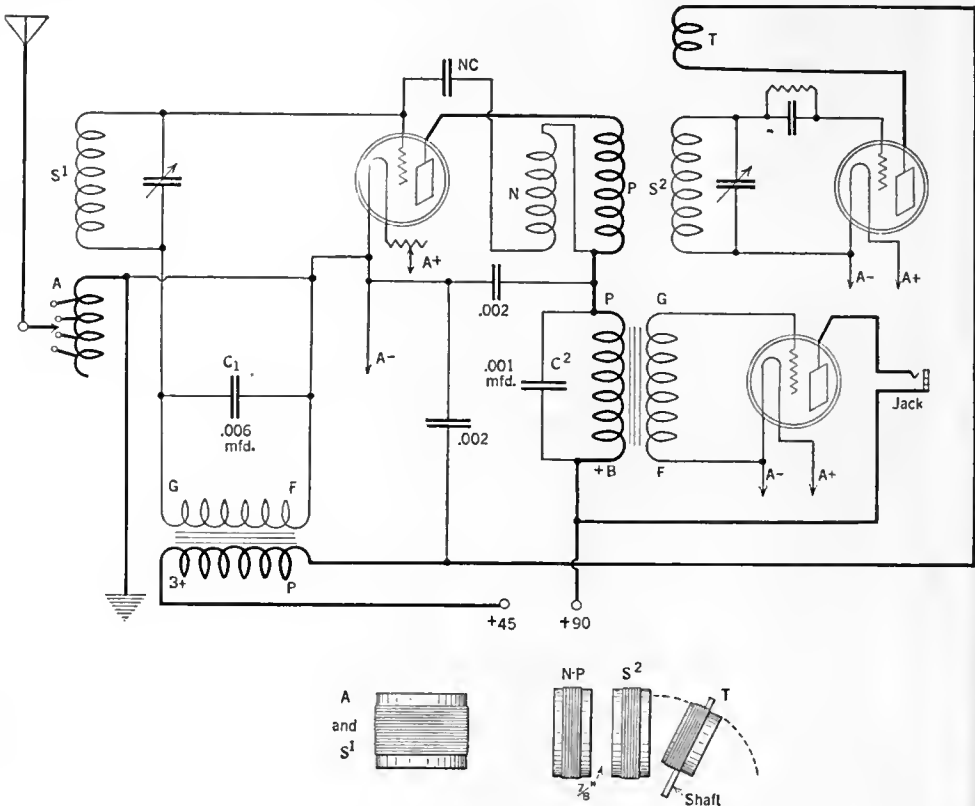

FIG. 3

and General Radio audio transformers are used throughout.

This set has brought in KGO Oakland at 820 miles west of San Francisco, in broad daylight, and practically every important station in the country at night, until we were so far west of San Francisco that the

to rotate within S-2. N-P should be placed about 3/8-inch from S-2 for best results. C1 and C2 were found necessary, as without them the receiver was found to be very unstable.

L. O. DORAN,  
San Francisco, California.

As stated elsewhere in this department, a \$25 prize is awarded each three months for the best contribution published. The winner for the December, January and February period will be announced in the next number of RADIO BROADCAST.



*"It works better than a lot of sets that sell for twice the price. I have owned four other sets and heard many more - and none beats this one."* **Now only \$59.50 Retail**

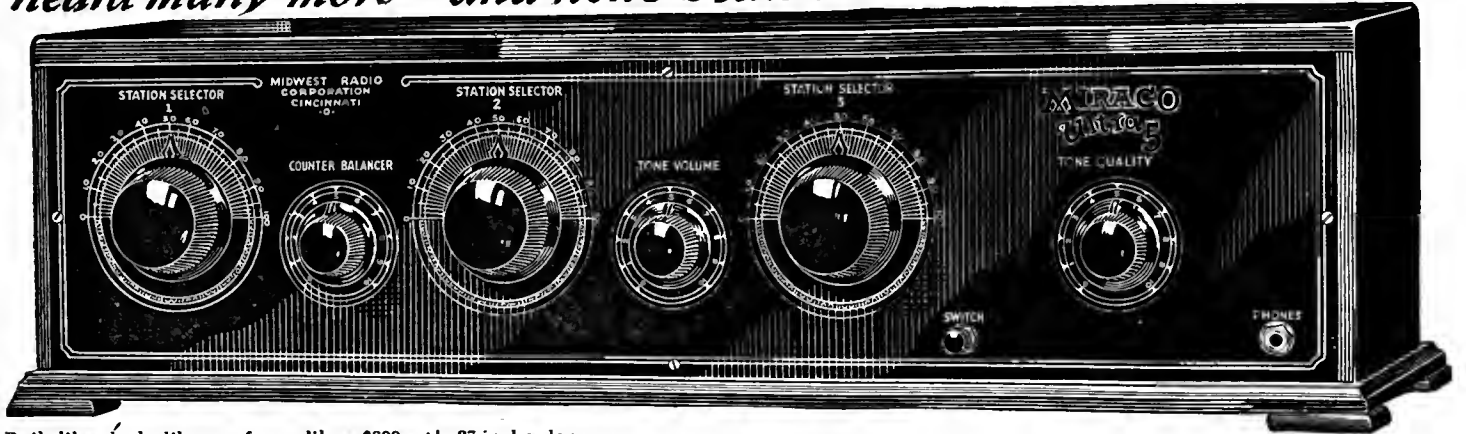

Built like—looks like—performs like a \$200 set!—27 inches long.

**Demand Breaking All Records—More User Agents Wanted—Get Wholesale Prices Quick**



**Notice!**  
Enormous demand for the celebrated Miraco Ultra 5 (resulting from its many enthusiastic users, so highly recommending it to their friends) enabled us to add hosts of costly new features, latest refinements and up-to-the-minute improvements such as you might expect to find only on the newest sets selling at much higher prices. So the Improved Ultra 5 for 1926 is even a better set—a more beautiful set—a more selective and more powerful set—incredible as this may sound!—for less money than ever before.

**COAST TO COAST RECEPTION VERIFIED BY USERS**  
Reports from Ultra-5 users everywhere leave little for us to add. These are only a few of the many in our files and which we receive daily. Send coupon for plenty of additional proof. Let testimony of users instead of high-sounding claims convince you.

**MANY SAY IT'S BEST THEY'VE HEARD**  
"Ultra 5" more than meets my expectations of a good radio set. Many think it is the best that they have heard. For volume, selectivity, clearness and long distance it is unsurpassed to my satisfaction. . . . Auto Supply, Allentown, Penna.

**PRaises the FINE TONE AND VOLUME**  
The Ultra-5 has a fine tone and good volume; last night had 24 different stations from 8 to 10—all on loud speaker. O. T. . . . Maline, New York.

**THE TONE IS "WONDERFULLY CLEAR AND POWERFUL"**  
Am more than pleased with my 5 tube Miraco. Tone wonderfully clear and powerful. D. C. . . . Detroit, Michigan.

**MORE PRAISE FOR MIRACO TONE QUALITY**  
The Ultra-5 received from you is the best I ever heard. It is just as clear as a crystal. Raymond W. . . . Massack, Ill.

**ONE OF THE clearest EVER HEARD**  
All who have heard my Ultra-5 set pronounce it one of the clearest they have heard, and I must say that the MIRACO is in every way as represented by you. George. . . . Colville, Washington.

**MONTANA HEARS BOTH COASTS**  
Ultra-5 set is O. K. Have got them. New York to Los Angeles. Wincooper to Dallas, Texas. W. H. . . . Polson, Montana.

**OHIO GETS 'EM COAST TO COAST**  
We are enjoying the Ultra-5 Radio. It is all you recommended. We set stations on the east coast, south and west coast. Walter. . . . Van Buren, Ohio.

**CALIFORNIA THE FIRST NIGHT**  
Headphones are not necessary with the Ultra-5. I had KFI, California, the first night with same volume as Pittsburgh. Fred G. . . . Liverpool, Ohio.

**COAST TO COAST FROM OKLAHOMA**  
With Miraco five tube set am getting stations on the Pacific and Atlantic coasts. Yerker E. . . . Pauls Valley, Okla.

**"COAST TO COAST" A REALITY**  
The two Miraco-5's have been working fine, in fact far beyond our expectations. Your statement of "coast to coast" reception proved absolutely a reality. T. D. . . . Houston, Texas.

**MICHIGAN GETS COAST TO COAST**  
I am overly pleased with the Miraco Ultra-5. Can get stations from coast to coast and from Texas to Canada. Geo. O. . . . Gordon, Michigan.

**LOTS OF VOLUME - 20 STATIONS FIRST NIGHT**  
Will drop you a few lines to let you know that I received my Miraco Ultra-5 and that it works fine. Had 20 stations the first night. . . . it has lots of volume. Fred. . . . Versailles, Ill.

The reports we print are from UNSOLICITED letters sent us by pleased users.

**INDIANA HEARS BOTH COASTS**  
Miraco Ultra-5 is a first-class set in every respect. It can't possibly be best for the price. The first night I received over twenty stations from both coasts. Adolph M. . . . Indianapolis, Indiana.

**MINNESOTA HEARS COAST TO COAST**  
Received Ultra-5 in fine condition. Have received programs from stations all over the United States and Canada. We find it is one of the best sets in this locality. We are well pleased with the wonderful results. Clarence. . . . Nashwauk, Minn.

**HEARS CALIFORNIA TO EUROPE**  
Enclosed is a partial list of the stations I received with the Miraco Ultra-5: KSD, WESH, WEAV, WFLA, WFLW, WGH, WJIS, WOR, WJAZ, WOC, WHAS, WWJ, CKAC, KFEX, WOK, WHAZ, WYAB, WHAA, in WASH, WCAP, WTAS, WQJ, KFEX, WAAW, WTAM, WOAI, WSOB, WCCO, WFLA, WFLW, WGH, WJIS, WFL, WHJ, WSZ, WHN, KFNE, KFL, WERI, WVL, WFAA, WAF, WOC, WCAZ, WHO, WCCA, WQAW, CFAC, WQAI, WOS, WCKE, KPUP, KBR, KFO, KFAA, WMCR, GKY, WCGE, WMAW, WBAF, WGN, KJR, WHI, WOS, WMC, WJL, WGA, WJL, WJL, WLV, WOOL, WBS, WFAI, WJAZ, KFS, WFF, KSAG, WTAI, KSKT, KFKR. On February 18th at 12:15 o'clock I received Ireland, the distance being several thousand miles. Richard. . . . Comertown, Mont.

**MONTANA HEARS CALIFORNIA TO IRELAND**  
I am more than pleased with the Ultra-5 Receiver. I have 90 stations on my record in 20 days' time, including KDKA, WCAL, KFLE, WEG, WCG, WIAM, WEAF, WEM, WGB, WGL, WLU, CAM, CFCF, WJL, WAE, KAKE, KOOW, WCCO, WOC, WCAZ, WHO, WCCA, WQAW, CFAC, WQAI, WOS, WCKE, KPUP, KBR, KFO, KFAA, WMCR, GKY, WCGE, WMAW, WBAF, WGN, KJR, WHI, WOS, WMC, WJL, WGA, WJL, WJL, WLV, WOOL, WBS, WFAI, WJAZ, KFS, WFF, KSAG, WTAI, KSKT, KFKR. On February 18th at 12:15 o'clock I received Ireland, the distance being several thousand miles. Richard. . . . Comertown, Mont.

**WEST VIRGINIA HEARS AUSTRALIA**  
Got 2-XB Wellington, Australia, plain last night at 12:40 A.M. over the Ultra-5 Miraco you sold me. I am delighted and would not trade for any instrument in town. Geo. . . . Glen Ferris, West Va.

**ALL WE CLAIM . . . AND MORE.**  
Miraco Ultra '5' Set in-cluded and would not trade for any instrument in town. Geo. . . . Glen Ferris, West Va.

**ALL WE CLAIM . . . AND MORE.**  
Miraco Ultra '5' Set in-cluded and would not trade for any instrument in town. Geo. . . . Glen Ferris, West Va.

**ALL WE CLAIM . . . AND MORE.**  
Miraco Ultra '5' Set in-cluded and would not trade for any instrument in town. Geo. . . . Glen Ferris, West Va.

**ALL WE CLAIM . . . AND MORE.**  
Miraco Ultra '5' Set in-cluded and would not trade for any instrument in town. Geo. . . . Glen Ferris, West Va.

**ALL WE CLAIM . . . AND MORE.**  
Miraco Ultra '5' Set in-cluded and would not trade for any instrument in town. Geo. . . . Glen Ferris, West Va.

**ALL WE CLAIM . . . AND MORE.**  
Miraco Ultra '5' Set in-cluded and would not trade for any instrument in town. Geo. . . . Glen Ferris, West Va.

**ALL WE CLAIM . . . AND MORE.**  
Miraco Ultra '5' Set in-cluded and would not trade for any instrument in town. Geo. . . . Glen Ferris, West Va.

**ALL WE CLAIM . . . AND MORE.**  
Miraco Ultra '5' Set in-cluded and would not trade for any instrument in town. Geo. . . . Glen Ferris, West Va.

**ALL WE CLAIM . . . AND MORE.**  
Miraco Ultra '5' Set in-cluded and would not trade for any instrument in town. Geo. . . . Glen Ferris, West Va.

**ALL WE CLAIM . . . AND MORE.**  
Miraco Ultra '5' Set in-cluded and would not trade for any instrument in town. Geo. . . . Glen Ferris, West Va.

The Powerful New **MIRACO Ultra 5**

Guaranteed by One of the Oldest Radio Builders

Tested and Approved by Radio's Highest Authorities

[ULTRA SELECTIVE FIVE TUBE SET IN MAHOGANY CABINET]

You can either *save* or *make* a lot of money on sets and supplies by sending coupon today for our *Amazing Special Offer!* It will astonish you. Big profits easy—accepting orders for Miraco Sets. Only necessary to order one set to demonstrate in your home. No agreements to sign—no salesmanship required. The performance of Miraco Sets does the selling. Greatest demand in the six years we have been building sets—we need more user-agents to supply it.

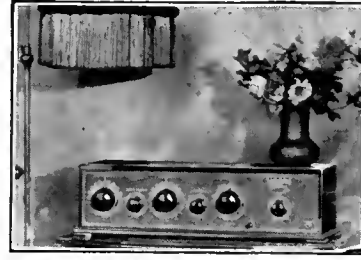

In the opinion of radio experts. Selectivity, long distance reception, clarity of tone, power and volume have been amazingly increased—"B" battery consumption is minimized—oscillations are easily controlled on all wavelengths, through use of latest radio inventions. Among these are: "Duoformers" (ultra low-loss inductance coils); the "Counter-Balancer" (patented); flexible wiring which prevents broken or noisy connections; an adjustment for different length aerials; use of only two rheostats; a cut-out switch; concealed wiring under genuine Formica base-

This latest improved 1926 model Miraco Ultra 5—completely built, thoroughly tested and factory guaranteed by the Midwest Radio Corporation, one of America's oldest, reliable and most successful makers of quality sets—is an

*The improved new Miraco Ultra-5 is a beauty! Hand-somely gold-etched genuine Formica panel and large dial with "arrow point" indicators (for fine tuning) add to the stylish appearance. Mahogany cabinet is hand-rubbed. A radio you will be proud to have your friends see and proud to have them hear perform.*

board and other features of costliest sets. Literature describes them fully. Send for it—and Special Offer that will surprise and interest you.

**AGENTS! DEALERS!**  
Write for the new Miraco proposition. Nation-wide use and popularity of Miraco sets, coupled with their amazingly low prices make them wanted everywhere.



Other Miraco Long Distance Sets \$13.75 up retail



Wonderfully improved new models in one-tube and three-tube Miraco Long Distance Sets also ready at lower prices! New Miraco R-3 at only \$27.35 (retail) operates loud speaker on distant stations. New one-tube Model R is also a record-breaker for distance at \$13.75. All Miraco sets work on storage or dry batteries, are easily connected and operated. Unmatched value! Let testimony of users convince you. Write for literature and Special Offer—use coupon.

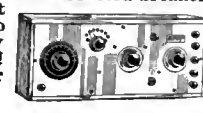

**All the Proof you want is waiting for You!**

Reports from hosts of users in every state prove Miraco sets—at rock-bottom factory prices—outperform sets costing up to three times as much. Send for latest literature, SPECIAL OFFER and plenty of additional testimony leaving no doubt that "Miraco Radio Gets 'em Coast to Coast."



Send coupon for **Amazing Special Offer!**

**MIDWEST RADIO CORPORATION**  
Pioneer Builders of Sets  
Cincinnati, Ohio

406-N East Eighth Street  
Send free literature. AMAZING SPECIAL OFFER and all particulars regarding your big money-saving proposition on Guaranteed Miraco Sets and all radio supplies.  
 Agent  User  Dealer.

NAME.....  
ADDRESS.....

## TONE

Full, sweet, mellow and natural, without the slightest indication of distortion, is another achievement that is making the APEX SUPER FIVE the most popular of all receiving sets.



## VOLUME

That supplies dance music or entertainment without any loss, is a feature for which the APEX SUPER FIVE is world famed.



## DISTANCE

Lends added enjoyment to radio with an indescribable fascination of tuning-in far away stations, which is always possible with the APEX SUPER FIVE.

Ask your dealer for a demonstration. Your eyes and your ears will tell you that APEX stands at the high point of perfection in both performance and appearance. \$80 without accessories.



## SUPER 5

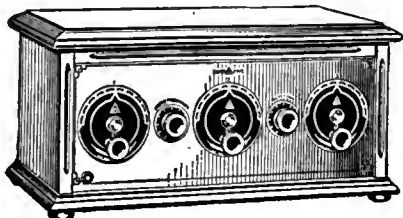

**APEX ELECTRIC  
MFG. CO.**

1410 W. 59th Street  
Dept. 104  
CHICAGO

# THE GRID

A Department Devoted to Solving the Problems of our Readers

## QUERIES ANSWERED

1. WHAT ARE THE VALUES OF THE CONDENSERS, RESISTANCES, AND BALLASTS ETC., FOR THE RADIO BROADCAST "ARISTOCRAT"?

T. J. L. Lansing, Michigan.

2. WHAT ARE THE CAUSES OF SOME OF THE NOISES PRODUCED IN MY RADIO SET? CAN THESE ORIGINATE AT THE STUDIO?

A. W. T.—Pompton Lakes, New Jersey.

3. WHAT IS THE THEORY OF OPERATION OF IMPEDANCE AUDIO AMPLIFIERS?

W. S. Burlington, Vermont.

### "ARISTOCRAT VALUES"

THE following values apply to the "Aristocrat" receiver which is shown diagrammatically in Fig. 1: C<sub>1</sub> and C<sub>2</sub>, .0005 mfd.; C<sub>3</sub>, .002 mfd.; C<sub>4</sub>, .0005 to .002 mfd.; C<sub>6</sub>, .00025 mfd.; C<sub>7</sub>, C<sub>8</sub>, and C<sub>9</sub>, not less than .01 mfd. C<sub>5</sub> is a midget variable condenser and its capacity approximates .00032 mfd. The values for the various resistances shown in the diagram, are as follows: R<sub>1</sub>, R<sub>2</sub>, R<sub>3</sub>, R<sub>4</sub>, and R<sub>5</sub> are filament ballasts, and their size will vary with the different types of tubes employed. Thus, for tubes consuming .25 amperes,  $\frac{1}{4}$  amp. ballasts are necessary, etc.; R<sub>6</sub>, 2 to 4 megohms; R<sub>7</sub>, R<sub>9</sub>, and R<sub>11</sub>, 100,000 ohms each; R<sub>8</sub>, approximately 1 megohm; R<sub>10</sub>,  $\frac{1}{2}$  megohm; R<sub>12</sub>,  $\frac{1}{4}$  megohm. The use of condenser C<sub>10</sub> often improves the results but its use may not be essential. Its capacity will be in the neighborhood of .002 to .004 mfd. A large capacity condenser of about half a microfarad will often improve the tone if connected across the B battery binding posts. In the original RADIO BROADCAST "Aristocrat," single

broadcasting, are often excessively noisy by induction from neighboring wires. A steady rushing sound, especially noticeable when the receiver is tuned to resonance, is often caused by the generator which supplies the plate potential to the transmitter tubes. This noise is more or less pronounced on all stations and continues until the broadcasting is finished and the stations sign off.

Noise contributed by the ether medium may be defined as those sounds which are caused by electrical disturbances between the broadcasting station and the receiver itself. In this group are found the disturbing influences of high tension power lines, violet and X-ray machines, leaky transformers, electrically operated elevators, sparking motors and generators, trolley and elevated systems, railway systems and telephone and telegraph wires, and a host of other electrical contrivances. Electrical impulses from those undesirable sources usually occur at short wavelengths and are picked up by sensitive receivers. Static also comes in this class and is

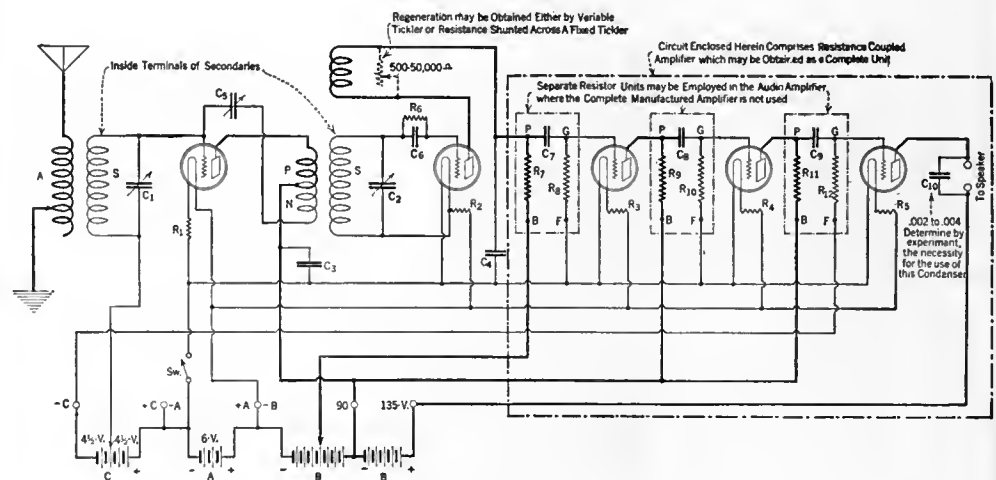

FIG. 1

units consisting of two resistances and a coupling condenser all in one piece were, among other arrangements, tried out. It is for this reason that the two resistances and coupling condenser preceding each audio amplifier tube are surrounded by dotted lines.

### NOISES AND THEIR CAUSES

IT IS possible that various noises heard through one's loud speaker can have originated at the transmitting station, but generally speaking the trouble can be traced to either the receiving equipment or the intermediate medium—the ether. Noisy microphones cause a steady hiss which often blurs the voice of the artist, while programs picked up outside of the studio and carried overland by wire for

more prevalent throughout the summer months. Many satisfactory programs are suddenly broken up by a series of unfamiliar clicks, and in many cases are interrupted entirely for short periods. Those may be caused by key clicks from continuous wave transmitters and by improperly operated regenerative and super-heterodyne receivers.

In another class are the noises which are caused by the receiver itself or by the equipment which is used in connection with it. Discharged B batteries become noisy and are usually the cause of a high pitched squeal when the receiver is operating on the second audio stage. These batteries should be discarded when their voltage drops below about thirty-four. Storage B batteries often cause the same trouble

# Made to Last

RADIO tubes will continue to be used for many years, and with careful, intelligent handling and periodic flashing with the Burton and Rogers Tube Flasher they will last for many years.

So will the Burton and Rogers Tube Flasher. It is made to last. Its genuine Bakelite panels, resistances accurate under all conditions and wound on porcelain, baked green enamel sides; proclaim its quality and insure its durability.

Electrically its design is based on fundamental principles and long experience and experimentation. It is the scientific development of an idea—not an unintelligent imitation of something else. And because *what is made right, looks right*, it is an ornament to the accessories of the most particular radio owner.

YOU CAN DO IT YOURSELF  
WITH A

**BURTON & ROGERS  
TUBE  
FLASHER**



★ \$7.50

One Model for D. C. or A. C. all cycles  
For tubes with thoriated filaments.

**BURTON & ROGERS MFG. CO.**  
755 Boylston Street, Boston, Mass.

## If Your Set Won't Percolate

write us about it. RADIO BROADCAST is establishing a special repair department to assist set builders in getting the best out of the receivers they build from plans published in the magazine. Write for complete information about this new department established for your benefit.

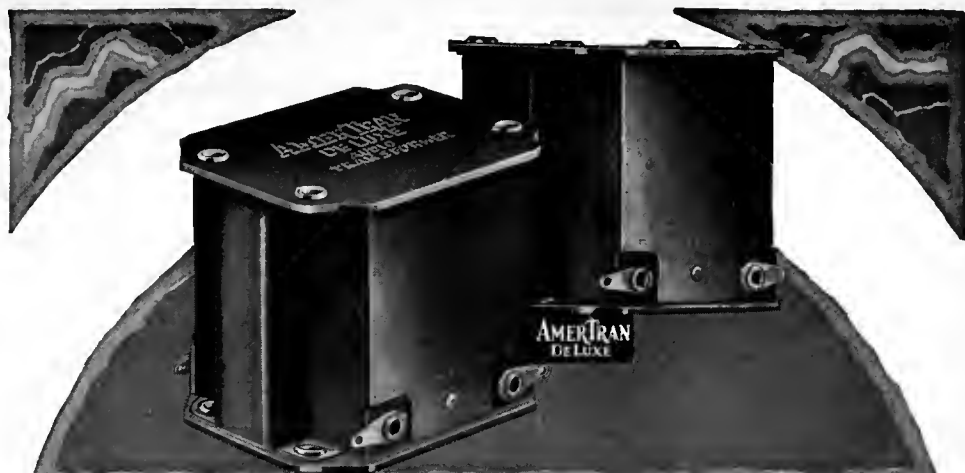

## Volume—with True Quality!

The value of radio as an entertainer increases only with the realism and quality of reception. This requires good broadcasting—reception and amplification equal to, or better than, the broadcast range of audio frequencies—and a loudspeaker of uniform response over the same range. Heretofore one of the weak links in this chain has been the audio amplifier.

But it is now possible with AmerTran DeLuxe audio transformers to obtain faithful, strong reproduction over a range of frequencies down to the lowest pitched audible sound. *This is nearly three octaves lower than that previously obtained.* The deep boom of the drum, the thrum of the base viol, and the thunder of the pipe organ are reproduced with startling realism—and at no sacrifice of the highest notes within the audible range. Once tried, the AmerTran DeLuxe will be recognized as setting a new high standard of excellence in audio amplification.

AmerTran DeLuxe requires no special circuit other than the use of a large tube in the last stage to prevent overloading at the low frequencies brought out. It is made in two types.

Price, either type, \$10.00

We have prepared a booklet describing these and other AmerTran products, together with recommendations for their use. We shall be glad to send you a copy upon request. ★

**AMERICAN TRANSFORMER COMPANY**

178 Emmet Street, Newark, N. J.

"Transformer builders for over twenty-four years"

SOLD ONLY AT AUTHORIZED AMERTRAN DEALERS



AmerTran Audio Transformers type AF6 (turn ratio 5) and AF7 (turn ratio 3½) have been substantially reduced in price. As before, they are today the leaders in their class. No changes have been made in the electrical characteristics since they were first sold. Either type now \$5.00. Be sure to see the other Amer-Tran ad on page 383

Why not subscribe to *Radio Broadcast*? By the year only \$4.00; or two years, \$6.00, saving \$2.40. Send direct to Doubleday, Page & Company, Garden City, New York.

Write for information

The new and improved line of

**ELDREDGE** ★

Pocket and Panel

Ammeters - Voltmeters - Voltammeters

**ELDREDGE ELECTRICAL CORPORATION**  
Springfield, Mass.

Established 1892

Dealers:--Address Dept. 5, for information

# Do you know about the "SUPERUNIT" FAMILY?

They are all tested assemblies which make possible the construction of various sets with no worry about the location of the parts.

They are all equipped with cushion sockets and nicked brackets.

They solve the problem for the folks who like to build their own sets.

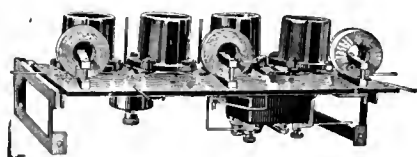

## 4-Tube "Superunit"

Type A for Standard base, Type B for UV199, Type C for UX tubes. Add two stages of audio for 6 tube set.....

**\$37.50**

## "Superunit-6"

The same as the standard type, but with two stages of Thordarson audio mounted and connected. Size 5x15 inches.....

**\$50.00**

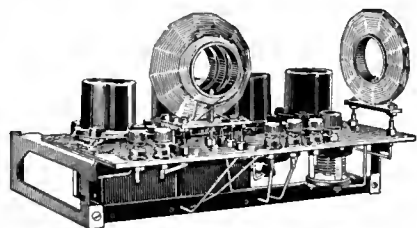

## "Superunit," Jr.

4 tubes with low loss plug in coils, R. F., detector and two stages of Thordarson audio.....

**\$37.50**

Any "SUPERUNIT" can be used with the S-C Capacity Element which we manufacture.

NOTE: The S-C Capacity Element is indicated by Mr. Arthur H. Lynch for the Radio Broadcast Aristocrat Receiver.

★ *Bulletins on request*

**Hanscom Radio Devices**

WOONSOCKET, R. I., U. S. A.

even when the voltmeter reading is high. Squeals in this case are caused by one or more dead cells which are usually not detected unless a voltmeter reading is taken of each individual cell.

Noises are sometimes caused by the vacuum tubes themselves. While outwardly they appear quite satisfactory, it sometimes happens that their internal elements are not rigidly supported, and any disturbance in the vicinity of the receiver may cause these elements to vibrate. This defect in construction produces a bell-like sound which has been known to build up in volume and drown out the program.

A somewhat similar sound may possibly be produced by placing the loud speaker on top of the receiver or by pointing the horn in the direction of the receiver. This may be remedied by a slight change in the position of the horn.

Noises are also caused by dirty prongs of vacuum tubes or by sockets which do not make perfect contact. These noises may be overcome by sandpapering the prongs of the tubes or by bending up the spring contacts of the tube sockets.

### IMPEDANCE AMPLIFIERS

THE desire for quality of tone, rather than excessive volume, is the dominant factor causing widespread investigation and research work in the quest of an audio amplifier that will entirely satisfy the critical tastes of the modern broadcast listener.

Up to recent times, transformer audio amplifiers have been accepted because very little was known about alternatives. The activity of independent investigators, however, led to very fine accomplishments as regards resistance-coupled amplifiers, yet there is still much to be found out about this very interesting phase of amplification work.

Now radio is repeating itself in a swing around

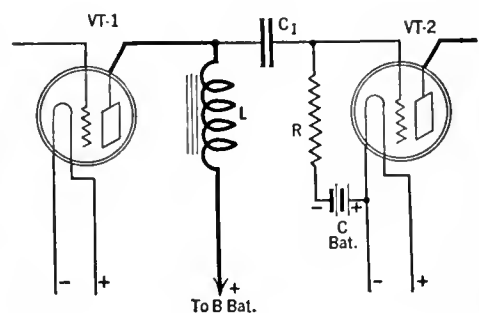

FIG. 2

the circle, and the old-time choke or impedance audio amplifier is coming into its own again.

Claims are being advanced to prove its particular advantages and superiority over other forms of amplification, and improvement has led to the development of a type of choke coil which has a satisfactory voltage step-up. Ordinarily, such amplifier units consisted of a single coil of wire having an iron core.

Such a coil is shown applied to an audio amplifying circuit in Fig. 2.

To-day, by means of a tap-off on the choke coil, it is possible to obtain a step-up ratio sufficient to overcome any drop that might take place in the condenser C. Commercially this type of choke coil is known as an "Autoformer."

Explaining the function of the circuit in Fig. 2, the variations in a.c. current in the plate circuit of the first tube set up a varying electromagnetic field in the choke coil; the e.m.f. produced is impressed upon the grid of the succeeding tube through the condenser C, which prevents the B battery potential from reaching the grid of the second tube.

Note the similarity in this type of amplifier

to the standard resistance type. In the latter, a plate resistance unit replaces the choke coil. Some claim that the resistance amplifier requires higher B battery voltage to be applied to the plates of the amplifying tubes, because of the drop in voltage through the high plate resistance. However, all tests conducted at the RADIO BROADCAST Laboratory tend to indicate that as low as ninety volts on the plate of the last stage resistance-coupled amplifier will operate entirely

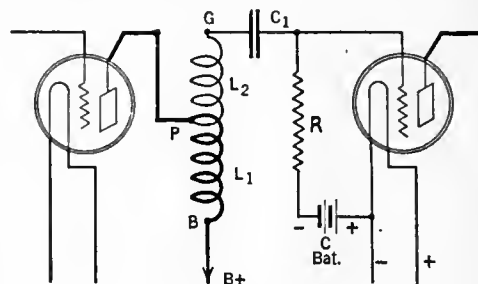

FIG. 3

satisfactorily. Of course, with the new high-Mu tubes, greater plate voltages are required.

The new type of choke coil, or impedance amplifier, as it is correctly called, employs the auto transformer system to obtain the desired step-up. In Fig. 3, P-B indicates the primary or plate winding of the coil, while G-B constitutes the secondary. Any variations of the electromagnetic field in P-B will cause corresponding but stronger variations in G-B. The resistance R, in both types of choke amplifiers, prevents excessive negative charges from piling up on the grid of the tube, by providing a leakage path back to the negative side of the filament. Ordinarily, the grid should be maintained at a negative potential in respect to the filament, and often a C battery is employed for this purpose; this, so that the tube may function on the proper part of its characteristic curve.

Several types of impedances suitable for use in an amplifier of this type, are finding their way to the radio market, and there are some companies, such as the Acme, General Radio, Dongan, Amertran, Thordarson, and National, that are either making such coils or have on stock a coil which may readily be employed in this capacity.

The experimenter may have an old transformer whose primary is burned out, in which case the secondary may be connected as in Fig. 2 to form quite an efficient choke coil for such an amplifier.

An important feature of the choke amplifier is the selection of a suitable isolating condenser, as C<sub>1</sub> is termed. If this condenser is too small, it will by-pass some of the higher frequencies. One on the order of .5 or 1 mfd. should be employed for satisfactory reproduction.

### WHEN WRITING TO THE GRID—

A TYPEWRITTEN letter, written on one side of the paper only, is to be preferred, as it aids in the quick formation of a satisfactory reply.

Don't fail to send a stamped addressed envelope with your inquiry.

Don't send a second inquiry about the first.

Don't include questions on subscription orders or inquiries for other departments of Doubleday, Page & Company.

In asking questions give us all the information that will aid in advising you. If the question relates to apparatus described in RADIO BROADCAST, give the issue, page number, and figure number of the circuit diagram, etc.

## Technical Booklets Worth Reading

Cardwell Quality Radio Parts are standard. Write for Bulletins on any or all of the following. They give a liberal education on radio theory and practice:

- 51 Variable Condensers
- 52 Special Condenser Types
- 55 Cordweave Coils (on press)
- 56 Transmitting Condensers
- 71 EQUITROL Dials
- 36 Engineering Service
- 37 Audio Transformers
- 82 Professional Set Builders Plan
- 85 Straight-Line Condensers
- 60 Dealer Electrotypes
- 72 Exclusive Dealer Agencies

PLEASE BE SURE TO CHECK BULLETINS IN WHICH YOU ARE INTERESTED.

**ALLEN D. CARDWELL**  
Manufacturing Corporation  
81 Prospect St. - - Brooklyn, N. Y.

## Antiques

interiors, houses, gardens, travel, sports, horses, dogs, blooded cattle—

all these are in

## Country Life

A Doubleday, Page Magazine  
Limited Supply at Newsstands

# The AMSCO ALLOCATING CONDENSER

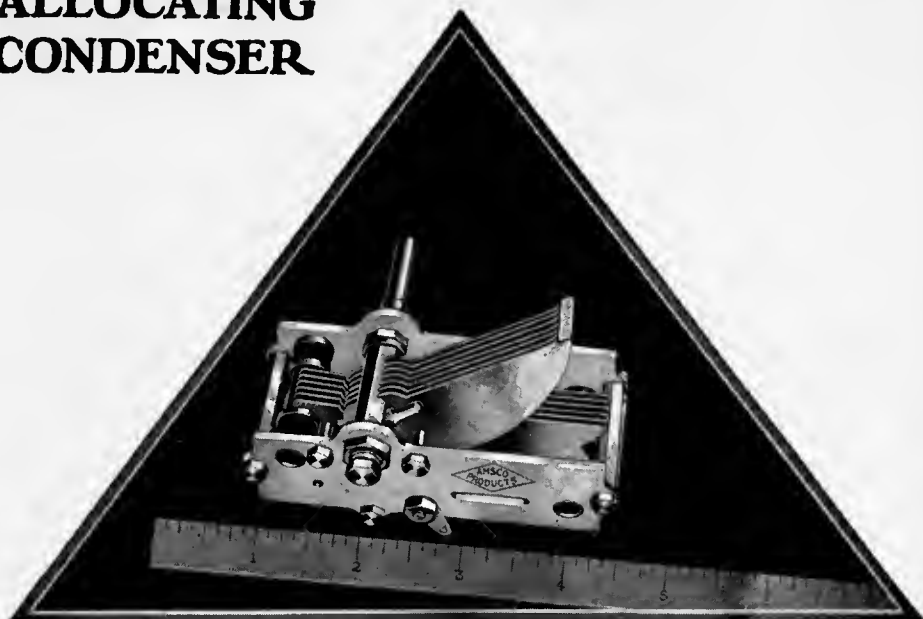

## IT SAVES SPACE!

This straight line frequency condenser is a space-saver in the radio cabinet . . . It can usually be substituted for the old time condensers in existing sets . . . Once installed, it revolutionizes your ideas about tuning . . . Those AmSCO half-a-heart-shaped plates add Kilocycles at the rate of ten to each dial division—giving "a station for every degree" . . . All wavelengths—high or low on the scale—tune in with equal ease . . . AmSCO allocation of the stations is uniform and correct to within a fraction of 1% . . . Insist on AmSCO Allocating Condensers . . . Made in six space-saving models, three Single and three Siamese, at very reasonable prices.

AmSCO Products, Inc.,  
Dept. E  
Broome & Lafayette Sts.  
New York, N. Y.

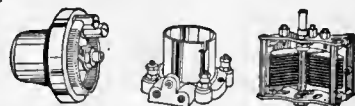

### OTHER AMSCO PARTS

Write for our booklet, "The Heart of the Hook-up" for full details and prices of the entire AmSCO line. AmSCO for Excellence.

## DEAFNESS IS MISERY GOOD HEARING A JOY



Millions of people know that, but Multitudes of persons with defective hearing and Head Noises are again enjoying conversation, go to Theatre and Church because they use Leonard Invisible Antiseptic Ear Drums, which are Tiny Megaphones fitting in the Ear entirely out of sight. No wires, no batteries, no head piece. They are Unseen Comforts and inexpensive. Write for booklet and sworn statement of the inventor who was himself deaf.

A. O. LEONARD, Inc., Suite 151 70 5th Ave., New York

## RADIO RENCH

Five strong little wrenches and a handy screw-driver fitting every nut and bolt on your radio. All held together by a patented device so none will be lost but easily detached for use.

Niagara Metal Stamping Corporation  
Niagara Falls, N. Y.

Folder Free

15¢

PREMAX

Send Payment Please  
Presented at cost to your dealer.

22½ Volt  
un-acid  
everlasting  
rechargeable  
"B"  
Storage Battery  
**\$2.95**  
includes  
chemical

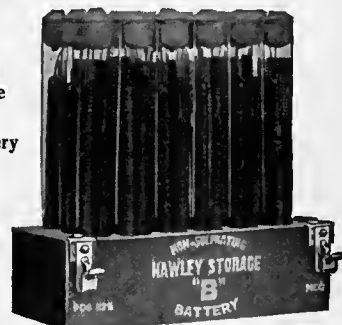

45 volts \$5.25, 90 volts \$10.00, 112½ volts, \$12.50, 135 volts \$14.75, 157½ volts \$18.80.

Truly the biggest buy today. Easily charged on any current including 32 volt systems. Any special detector plate voltage had. Tested and approved by leading authorities such as Popular Radio laboratories. Over 3 years sold on a non-red tape 30 day trial offer with complete refund if not thoroughly satisfied. Further guaranteed 2 years. Knock-down kits at greater savings. Complete "Hawley" "B" Battery Charger \$2.75. Sample cell 35c. Order direct—send no money—simply pay the expressmen cost on delivery. Or write for my free literature, testimonials and guarantee. Same day shipments.

B. Hawley Smith, 312 Washington Ave., Danbury, Conn.



## FAHNESTOCK CONNECTORS

Popular Wherever Radio is Used!

**Antenna Connector**  
Eliminates splicing and soldering of wires. Snap larger connector over antenna wire; insert lead-in wire into smaller clip and a perfect connection is the result.

Made of the finest quality Phosphor Bronze. SPECIES HERE

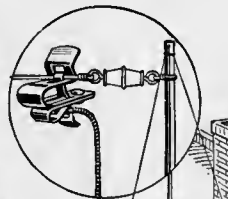
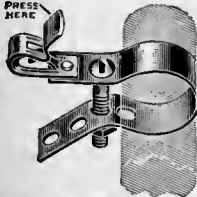

**Ground Clamps**  
Eliminates soldering, easily attached. Made from soft copper 5/8" wide with a phosphor bronze spring binding post, also a screw and nut attached.

**FAHNESTOCK ELECT. CO.**  
L.I. CITY, N.Y.

# Ring in the New Year!!

Listen to the clear tinkling bells on the frosty midnight air—at the stroke of 12.

## Why Not Use the "B" Rectifier?



Rhamstine★ "B" Rectifier

Only \$25

(Tube not included)

A Rhamstine\* "B" Rectifier eliminates "B" Battery troubles, converts alternating current (110 volts) into direct current, and assures a continuous flow of power through Radio receiving set at a constant voltage. The "B" Rectifier gives you better reception and reproduces the original sound in all its natural fullness. Its efficiency will amaze you. Endorsed by Radio Manufacturers and Dealers. Why not get one? Sold on assured satisfaction—you can depend upon Rhamstine\* quality and performance. Send no money. Just check the coupon.

## Why Buy New Tubes?

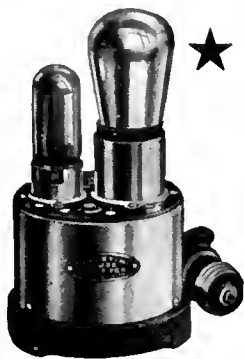

Rhamstine★ Tube Booster

Only \$6

★ A Rhamstine\* Tube Booster will re-energize the filament and reproduce the clear tones, and give better volume and reception. A few minutes, once a month, will re-create the energy in the old tubes and make them just like new.

Works on any A. C. 110-120 volts, 50-133 cycles—201A or 199 type tubes.

Mail the Coupon To-day

J. THOS. RHAMSTINE\* (t)

506 E. Woodbridge, Detroit, Mich.

Please send me

Rhamstine\* Tube Booster at \$6

Rhamstine\* "B" Rectifier at \$25

by express C. O. D. subject to inspection. If I am not entirely satisfied with the "B" Rectifier I will return it to you in five days and receive a refund of the full purchase price.

Name.....

Address.....

City.....

J. THOS. RHAMSTINE★

Radio and Electrical Products

506 E. Woodbridge St., Detroit, Mich.

# THE BEST IN CURRENT RADIO PERIODICALS

The Third Installment of a Useful Classified Survey of Material Appearing in the Radio Press

By E. G. SHALKHAUSER

How This Survey Can Help You

HOW often have you looked for information contained in some article which you recall having read months ago—the description of the Browning-Drake receiver, or the measurement of losses in inductance coils, for example? After looking through probably several issues of a dozen different publications, you either give up or become interested in something altogether different.

When data is wanted on some particular subject, a systematic file of subjects and titles becomes a real radio encyclopedia. Instead of having merely the title of an article given, which often is misleading, a summary of the contents gives all the information. These surveys cover the radio field as gleaned from material in to-day's periodicals. They will always serve as a future reference-guide to all who are interested in the science of radio, whether engineer, manufacturer, dealer, experimenter, or listener.

To be of practical value and easily accessible, these surveys should either be filed in a scrap book, or, better still, be pasted on individual cards and filed according to numbers, or alphabetically. In the matter of classification of articles, the Bureau of Standards circular No. 138 has been followed. This may be obtained from the Government Printing Office, Washington, District of Columbia, for ten cents. In addition, each abstract has certain key-words placed at the upper right, which may be used for the purpose of filing articles alphabetically.

With this series of surveys we hope to aid our readers and help them through many difficulties which they no doubt have often experienced. In future we will give information and references to articles previously surveyed upon receipt of a stamped and self-addressed envelope.

Following is the series of headings, made up according to the Dewey Decimal System used in the Bureau of Standards circular No. 138:



### R000 RADIO COMMUNICATION IN GENERAL.

Under this heading will appear all subject matter pertaining to laws, regulations, history, publications, etc., which deal with radio in a general way.

### R100 PRINCIPLES UNDERLYING RADIO COMMUNICATION.

Here will be given the phenomena of radio waves, their underlying theory of propagation, the principle of antenna and counterpoise, design and characteristics of vacuum tubes and their behavior in circuits, types of circuits, transmitting and receiving apparatus and their principles of operation.

### R200 RADIO MEASUREMENTS AND STANDARDIZATION METHODS.

The various known methods which have been used in measuring frequency, wavelength, resonance, capacity, inductance, resistance current, voltage, dielectric constants, and properties of materials, will be mentioned here.

### R300 RADIO APPARATUS AND EQUIPMENT.

A description of various types of antennas and their properties, the use of the electron tube in various types of receiving and transmitting sets, other methods of transmission of signals, various detecting devices used in reception, instruments and parts of circuits, come under this heading.

### R400 RADIO COMMUNICATION SYSTEMS.

The spark, modulated wave and continuous wave systems in transmission, beat and other methods of reception, wired wireless, automatic printing, the buzzerphone and Fullerphone, will be given here.

### R500 APPLICATIONS OF RADIO.

To aviation, navigation, commerce, military, private and broadcasting, and the specific information under their headings, are referred to here.

### R600 RADIO STATIONS.

The operation, equipment, and management of radio installations, both transmitting and receiving, the testing, the rules and regulations concerning stations, the reports and bulletins issued, will follow under this heading.

### R700 RADIO MANUFACTURING.

Data relative to costs and contracts of radio equipment from raw material to finished product, including factories, tools, equipment, management, sales and advertising, follows here.

### R800 NON-RADIO SUBJECTS.

The matter of patents in general; the mathematics and physics, including chemistry, geology and geography; meters of various kinds; all information not strictly pertaining to radio but correlated to this subject, will be found under this heading.

### R900 MISCELLANEOUS MATERIAL.

## A Key to Recent Radio Articles

R333. THREE-ELECTRODE TUBES. VACUUM TUBES, *Life Testing*

*Proceedings I.R.E.* Oct., 1925, pp. 625-645.

"Life Testing of Tungsten Filament Triodes," W. C. White.

Triodes are life-tested primarily as an aid to the manufacturers in proving their performance and useful length of service rather than to obtain any average life figure. The apparatus employed and its method of operation, together with the procedure in handling the data, is next described. Actual results obtained are given to illustrate the methods used. These results are outlined in the form of tables and curves. One point emphasized throughout the paper is that triode life is just as much a variable factor as other factors, such as electron emission or impedance.

R430. INTERFERENCE ELIMINATION. INTERFERENCE, *Popular Radio.* Oct., 1925, pp. 318-323. *General.*

"How to Improve Broadcast Reception," J. V. Hogan. Part VII.

The question of interference in broadcast reception is taken up from the receiver standpoint. The receiving set can be made very selective by proper choice of apparatus and good arrangement of parts. Various primary and secondary circuits are discussed in detail, and their advantages and disadvantages noted.

R110. RADIO WAVES. MAGNETISM OF EARTH AND WAVES

*Popular Radio.* Oct., 1925, pp. 309-316.

"How Earth Magnetism Affects Radio Waves," H. Nichols and J. Schelleng.

The discrimination made against waves of different frequencies by the medium through which they travel, has changed our ideas of wave propagation within recent years. The atmosphere is supposed to have a marked effect on electromagnetic waves, much as a glass prism has on light waves. Because electrons move in the magnetic field of the earth, we would expect them to be affected by this field. Such an effect seems to be particularly noticeable at about 1199 kilocycles (250 meters), and the much-discussed question of fading may be explained in this way.

R134.4 REGENERATIVE ACTION. OSCILLATIONS AND REGENERATION.

*Popular Radio.* Oct., 1925, pp. 388-390.

"The Prevention of Oscillation and Control of Regeneration in R. F. sets."

Radio frequency receivers usually have the tendency to oscillate at some frequency, especially if more than one stage is used. Several methods are described which can be used to prevent such undesirable noises. Diagrams are added to aid in applying these remedies

A new line of  
**COIL UNITS**

USING



**HEXCELL COILS** ★



Complete set of coils for Roberts circuit, List Price \$6.

	List Price
3 circuit HEXCELL tuner 200-575 meters.....	\$3.00
Complete set of HEXCELL coils for Roberts circuit.....	6.00
Complete set of HEXCELL coils for Browning-Drake circuit with new improvements.....	6.00
Short wave HEXCELL extra low loss 3 circuit tuner 40-115 meters.....	3.50

We have put real electrical and mechanical engineering into our inductances. Particular attention is given to efficient operation at the lower end of the Broadcast Wave Band.

Our coils are finished in beautiful silk shades, each coil having a different color. Highly polished bakelite and nickel mounting parts used. Merchandise packed in attractive boxes.

A live line for live dealers  
Liberal jobber and dealer discounts

Write for information

**EASTERN ELECTRIC & MANUFACTURING COMPANY**

Providence, Rhode Island

Licensed manufacturers of Zig-Zag Coils

**ACME WIRE RADIO PRODUCTS**

**Flexible Celatsite**

Flexible stranded wire for "point to point" and sub-panel wiring latest method of wiring sets. Five colors, black, yellow, green, red and brown, one for each circuit. Twenty-five foot coils.



**Stranded Enameled Antenna**

The best outdoor antenna you can put up. 7 strands of enameled copper wire; maximum surface for reception. Enameling prevents corrosion and consequent weak signals. 100, 150 or 200 ft. coils, boxed.



**Original Celatsite Wire**

Celatsite is a tinned copper buss bar wire with a non-inflammable "spaghetti" insulation in five colors. Supplied in 30 inch lengths.

**Flexible Varnished "Spaghetti"**

A perfect insulation tube for all danger points in set wiring. Costs a little more and is worth a lot more than the cheaper substitutes offered. Black, yellow, red, green, brown; for wires No. 10 to No. 18. 30 inch lengths.



**Celatsite Battery Cable**

For connecting A and B Batteries (or current supply) to radio set. Silk braid covering 5 flexible Celatsite wires—5 feet long—a different color for each terminal. Prevents messy wiring and "blown" tubes. Adds greatly to the appearance of your set.



Send for Folder

**THE ACME WIRE CO., Dept. B** ★  
New Haven, Conn.

**Antiques**

interiors, houses,  
gardens, travel,  
sports, horses, dogs,  
blooded cattle—

all these are in

**Country Life**

A Doubleday, Page Magazine  
Limited Supply at Newsstands

High Grade  
**SETS BUILT TO ORDER**

Repaired—Adjusted

Specialists in Hammarlund-Roberts,  
Roberts and Super-Hets

RADIO RESEARCH LABS.,

154 Nassau Street New York City

**RADIO DEALERS**

Send for our catalogue

New Circuits New Parts

Silver-Marshall Distributors

VAN-ASHE RADIO CO.

202 N. 10th St. St. Louis, Mo.

This is a good time to subscribe for

**RADIO BROADCAST**

Through your dealer or direct, by the year only \$4.00  
DOUBLEDAY, PAGE & CO. GARDEN CITY, NEW YORK

**Potter**  
BY-PASS  
**Condensers**

- Prevent "B" voltage fluctuation
- Allow undistorted amplification
- Make possible full bass tones
- Improve reception with "B" Supply Units. ★

Made in  $\frac{1}{10}$ ,  $\frac{1}{5}$ ,  $\frac{1}{2}$ , 1, 2, 3 and 4 Microfarad sizes  
Order from Your Jobber

POTTER MANUFACTURING COMPANY  
North Chicago, Illinois





# ROPE-CORE AERIAL

A marvelous, new aerial that is guaranteed to give greater distance, easier tuning, more perfect selectivity. Consists of pure copper ribbon, heavily enameled, wound around sturdy, weather-proof rope. Try this new aerial for better reception.

- ★ 50 ft. \$3.00      100 ft. \$5.00
- 75 ft. 3.85      150 ft. 7.00



### ACORN WINDOW LEAD-IN

Fits into sash as pictured. Made of pure copper ribbon— $\frac{1}{2}$  inch wide, heavily enameled by special process. Triply insulated with waterproofed fabric. Thousands of users recommend them for satisfactory service. Each 35c. (Unenameled—25c.)

### ACORN MASTER-SWITCH

Instantly connects your Battery to charger or to your receiver.

- Single socket type, \$5.00.
- Double socket type, \$6.25.

(For use with B-Eliminator)

Send for circulars on Acorn Products.

Dealers—Write for Discounts—Jobbers

Acorn Radio Products Co.  
708-A W. Madison St. Chicago

## 400 CENTS RESISTANCE

is the subscription price to Radio Broadcast for one year. This is less than the cost of a good low loss variable condenser. Let us enter your subscription to begin with the next issue.

Send \$4.00 with your name and address to Radio Broadcast, Garden City, N. Y.

GENUINE  
BAKELITE

# Radio Panels

We cut, drill and engrave for you Radio Panels of genuine Bakelite.

Send rough sketch for estimate. A properly drilled and engraved panel ready for mounting is half the job of construction. Plain panels shipped C. O. D. same day order is received. Write for New Catalog on Radio Panels, Tubes and Rods—all of genuine Bakelite.

STARRETT MFG. CO.  
521 South Green St.  
CHICAGO



## A Real Power Transformer

The modern home may now utilize its electric service for the operation of a Radio Receiver. Reception is greatly improved when efficient B and A eliminators are employed to use this steady power.

The AmerTran Power Transformer Type PF-45, 65 VA—60 cycles 110 volts primary, 450-8/4-8/4 secondary, is intended for use in converting the standard 110 volt, 60 cycle alternating house lighting current to a higher voltage for the plate and low voltages for filament supply. It can be depended upon to give good results when used in connection with the different tubes now available and is designed with the usual margin of safety. It is a real power transformer, in design, construction and usefulness.

The AmerTran Power Transformer Type PF-52 is another transformer of the AC Power Type similar to Type PF-45 except that it has a plate winding for 525 volts AC and a metal ground shield between the primary and secondary windings.

PRICE, Type PF-45, \$15.00—Type PF-52, \$18.00

We have prepared a booklet describing these and other AmerTran products, together with recommendations for their use. We shall be glad to send you a copy upon request.

## AMERICAN TRANSFORMER COMPANY

178 Emmet Street, Newark, N. J.

"Transformer builders for over twenty-four years"

SOLD ONLY AT AUTHORIZED AMERTRAN DEALERS

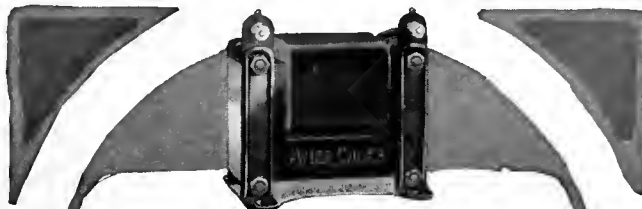

The AmerChoke Type 854 is a choke coil or impedance of general utility designed primarily for use in filter circuits. It has a current capacity up to 60 milliamps, and a no load inductance of approximately 100 henrys at 60 cycles. Price \$6.00 each. Be sure to see the other Amer-Tran ad on page 377

Order your copy of Radio Broadcast from your news dealer or radio store. Make sure that he reserves a copy for you each month. If your favorite radio store does not stock the magazine write us giving name of radio dealer and address.

A Laboratory Product



## CRESCENT LAMPE RESISTANCES

for Distortionless Amplification  
As transmitting Grid leaks, they are made in special sizes and are not afraid of power. Dissipate 10 watts. Four standard sizes \$1.50 each. Special resistances \$2.50 each.

Crescent Radio Supply Co. 1-3 Liberty St., Jamaica, N. Y.

Why not subscribe to Radio Broadcast? By the year only \$4.00; or two year, \$6.00, saving \$2.40. Send direct to Doubleday, Page & Company, Garden City, New York.

## LEARN THE CODE AT HOME with the OMNIGRAPH

"Just Listen—The Omnigraph will do the teaching"

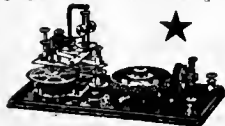

THE OMNIGRAPH Automatic Transmitter will teach you both the Wireless and Morse Codes—right in your own home—quickly, easily and inexpensively. Connected with Buzzer, Buzzer and Phone or to Speaker, it will send you unlimited messages, at any speed, from 5 to 50 words a minute.

THE OMNIGRAPH is not an experiment. For more than 15 years, it has been sold all over the world with a money back guarantee. The OMNIGRAPH is used by several Deps. of the U. S. Govt.—in fact, the Dept. of Commerce uses the OMNIGRAPH to test all applicants applying for a Radio license. THE OMNIGRAPH has been successfully adopted by the leading Universities, Colleges and Radio Schools.

Send for FREE Catalogue describing three models. DO IT TO-DAY.

THE OMNIGRAPH MFG. CO., 13K Hudson St., New York City

If you own a Radio Phone set and don't know the code—you are missing most of the fun



## Whether You Buy or Build

## Insist on EBY Cushion Sockets

THE most important elements in any set are the tubes. There's no getting around that! And what else but the sockets are responsible for the life and efficiency of those tubes? Whether you build or buy see to it that the tubes in your set are mounted on EBY Cushion Sockets.

The design of this revolutionary socket provides a three-point wiping contact on each of the four tube prongs. Each spring clip acts as a shock-absorbing cushion for the tube and is securely riveted to the base eliminating all microphonic noises and protecting the tube against damage from vibration.

Furthermore, EBY Cushion Sockets, which are now ready for delivery, fit all standard tubes including the new UX.

Manufacturers, jobbers and dealers write for complete information



Here is the socket that many of the foremost manufacturers and set builders depend on for 100% tube efficiency and protection. You can get them at most **60c** good dealers for Each

### H. H. EBY MFG. COMPANY

Makers of EBY Quality Binding Posts

4710 Stenton Ave.

Philadelphia, Pa.

#### R431. STRAYS. INTERFERENCE.

*Radio*, Oct., 1925, pp. 17ff.  
"How to Reduce Interference," L. W. Hatry.  
Most receivers in use to-day employ the untuned primary method of reception. This is undesirable from several standpoints. A method whereby greater selectivity can be obtained, is described, by adding a loading coil to the antenna circuit. This will permit rough tuning of the antenna circuit and insure much better reception.

#### R127. ANTENNA CONSTANTS. ANTENNA

*Radio*, Oct., 1925, pp. 20ff.  
"How Antenna Characteristics Affect Reception," K. B. Morcross.  
A description of the effect of resistance, capacity, inductance, direction, height, length and surroundings, of an antenna on transmission and reception of ether waves, is given. Various types of antennas are discussed, and equations are presented and interpreted for the benefit of the less experienced in the radio art.

#### R134.4. REGENERATIVE ACTION. OSCILLATIONS

*Radio*, Oct., 1925, pp. 22f.  
"Elimination of Oscillations in R. F. Amplifiers," Dr. Buchbinder.  
An analysis of the causes of oscillations and several of the methods used in preventing oscillations in radio-frequency amplifiers is given. Three general methods are employed usually: 1. Decreasing the amplification efficiency through losses; 2. Reducing stray magnetic and electro-static fields; 3. Using balancing-out arrangements. The last method is suggested as being the best because it leads to sensitive and selective receiving.

#### R145. REACTANCE REACTANCE

*Radio*, Oct., 1925, pp. 24f.  
"How Radio Circuits Work," G. F. Lampkin.  
A theoretical discussion of resistance, capacity and inductance in radio circuits is presented. Graphs and concrete examples of the application of various equations to typical radio circuits brings this much misunderstood and difficult information within the grasp of the average experimenter.

#### R384.1. WAVEMETERS WAVEMETER.

*Radio*, Oct., 1925, pp. 29ff.  
"A Detecting, Oscillating and Modulating Radiocast Wavemeter," E. E. Griffin.  
The construction and operation of a simple wavemeter, which may be used as a receiver, a modulator, or an oscillator, is given. In design and general arrangement it resembles any ordinary one-tube receiving set, but its uses are many. Method of calibration and testing is given. Its many uses in measuring constants of radio apparatus make this one of the best laboratory instruments for any radio worker.

#### R420. MODULATED WAVE SYSTEMS. MODULATING

*Radio*, Oct., 1925, pp. 31-32.  
"Plate and Grid Modulation Systems," L. Grignon and F. Jones.  
A constant carrier frequency is modulated by either a decrease in antenna current (Heising system) or a decrease or increase in antenna current (grid modulation system). The theory underlying these two methods, their advantages and disadvantages on the broadcast range of wavelengths, as discussed, lead the authors to believe that the grid system of modulation is the better. Circuit diagrams and data are given for the benefit of those wishing to try out these two systems for comparison.

#### R351. SIMPLE OSCILLATORS. OSCILLATOR,

*Radio*, Oct., 1925, pp. 33-34.  
"A Quartz Crystal Oscillator," D. B. McGown.  
A description of this new form of instrument, used as a standard of wavelength, and information on the construction of such an instrument, is given. The Hartley circuit is used. The parts that enter into the building of this oscillator are all standard and easily obtainable. It can be used as any other oscillator. Its accuracy is said to be much greater than ordinary forms of oscillators.

#### R342.6. RADIO-FREQUENCY AMPLIFIERS. RECEIVER,

*QST*, Oct. 1925, pp. 8-11.  
"A True Cascade R. F. Amplifier," Dr. L. M. Hull.  
According to Mr. H. Snow's experimental study, the so-called intermediate-frequency amplification in super-heterodynes, using three tubes, will not give a voltage gain of more than from 800 to 1000. A marked "tapering-off" effect is usually apparent. Straight cascade one-way stages were tried at 750 kc. with a voltage gain, starting with seven, of seven times for each tube used. Five tubes gave an amplification of more than 16,000. A description of the set, its peculiarities of construction, and a circuit diagram are given. The instrument is very selective and has but two controls.

#### R113. TRANSMISSION PHENOMENA. SHORT WAVES,

*QST*, Oct. 1925, pp. 12-21.  
"Wave Propagation at High Frequencies," Dr. A. H. Taylor and E. Hulbert.  
This article contains a detailed discussion concerning the probable condition of the upper ionized atmosphere and its effect on the propagation of waves at high frequencies. Ionization, de-ionization, wave-energy losses, absorption, skipped distances and their cause, effects due to frequency changes, day and night transmission—these are subjects taken up in turn and discussed in a very clear manner. Experimental evidence substantiates most of the statements made; curves and diagrams serving to illustrate points in question.

#### R005. EXECUTIVE, ADMINISTRATIVE. AMATEURS LINKED

*QST*, Oct. 1925, pp. 22-24.  
"The Army links up with the Amateur," A. R. L. Plan.  
A plan whereby amateur stations located in the United States will cooperate with the United States Signal Corps for a four-fold purpose: 1. To have channels available in case of emergency; 2. To have channels available for civilian components of the army; 3. To have operators available trained in army methods; 4. To have contact available between operators and Signal Corps for the exchange of new ideas in experimental work. The plan of affiliation is given verbatim.

**\$ DOLLAR VALUES \$**

*The*  
**RADIO BROADCAST**  
*Series of*  
**KNOCK-OUT RECEIVERS**

**Nine Receivers  
Fully Described**

*Additional Explanatory Notes  
on Coils, Tubes, Neutralization,  
Two-Element and Crystal  
Rectifiers*

**T**HE AUTHORS who have contributed the wealth of information and constructional data contained in this book are well-known for their past works. Read what Walter Van B. Roberts, Bouck, Brennan, Kenneth Harkness and Dr. L. M. Hull have to say about Reflex "Knock-Outs."

**\$ DOLLAR VALUES \$**

*How to Make the*  
**Radio Broadcast Knock-Out  
Four-Tube Roberts Receiver**

*Two Full-Sized Blue-Prints  
Showing the Constructional and  
Wiring Details Accompany  
the Instruction Book*

**A Non-Radiating  
Receiver, Easy to  
Build and Operate**

**I**N THIS BOOK John B. Brennan, Technical Editor of RADIO BROADCAST, tells how to make a Four-Tube Receiver having excellent tone quality characteristics. Since September, 1924, this receiver has commanded the attention of thousands of readers of RADIO BROADCAST and it is still going strong. The blue-prints, which are full-size, enable you to easily construct this economical receiver.

**DEALERS:**

RADIO BROADCAST will tell you how to make sales that stay sold. Write to us for our proposition.

**---Now!**

**\$ DOLLAR VALUES \$**

*How*  
**RADIO RECEIVERS WORK**

*by* **Walter Van B. Roberts,**  
B. S., E. E., Ph. D.

**The Up-To-Date Radio For the Radio Constructor  
Easily Understandable and Experimenter**

*Profusely Illustrated*

**H**ERE ARE SOME of the topics discussed in this Book: Electrons, The Volt and The Ohm, Impedance, Transformers, Simple Receivers, Regenerative Circuits, Loud Speakers in General, The Reason for the Super-Heterodyne, Problems of "Super" Design, Radio Tubes, Etc.

This is a six-chapter book that deals with up-to-date apparatus, and modern circuits. 53 pages, 65 Illustrations.

**\$ DOLLAR VALUES \$**

*How to make*  
**RADIO BROADCAST'S  
ARISTOCRAT RECEIVERS**

*by* **Arthur H. Lynch**

**T**HE BUILDER has his choice of two types of Aristocrat Receivers and the blue-prints which are full-sized show complete wiring, location, and constructional details. These prints are accompanied by an instruction pamphlet prepared by Arthur H. Lynch, Editor of RADIO BROADCAST.

The receivers embody the most modern features of circuit design such as a neutralized radio-frequency amplifier, regenerative detector, and three-stage resistance-coupled amplifier. Provision is made for the use of high-Mu tubes with high voltage and proper grid bias on the last audio amplifier.

**GET ALL FOUR OF THESE DOLLAR VALUES FOR THREE DOLLARS, OR, SINGLY AT ONE DOLLAR EACH. THIS IS THE BIGGEST RADIO LITERATURE OFFER MADE IN MANY A DAY!**

RADIO BROADCAST,  
Garden City, New York.

Gentlemen: SEND ME

- 1—ALL FOUR DOLLAR VALUES FOR THREE DOLLARS—ENCLOSED.
- 2—The RADIO BROADCAST Series of Knock-Out Receivers, for \$1.00, enclosed.
- 3—The RADIO BROADCAST Knock-Out Four-Tube Receiver Blue-Prints and Book for \$1.00, enclosed.
- 4—How To Make Radio Receivers Work, for \$1.00, enclosed.
- 5—How To Make RADIO BROADCAST'S Aristocrat receivers, for \$1.00, enclosed.

Name .....

R.B.E.

Address .....

# Superadio Receiver

5  
Tubes  
—  
2  
Dials

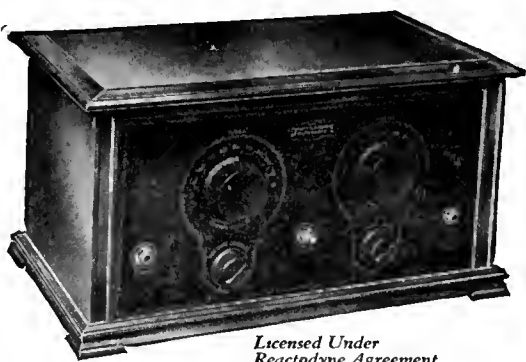

Licensed Under  
Reactodyne Agreement

Many  
New  
Fea-  
tures  
—  
\$56

**D**ISTINCTLY new engineering has produced in the Superadio a distinctly new type of Set with a richness of tone quality absolutely unequalled. S. L. F. condensers, tuned radio frequency with individual R. F. tube control and many other advanced features. Designed for low upkeep cost, maximum results are obtained with lowest possible drain on batteries and wear on tubes.

Ask your dealer or write us

## Superadio Dynamometer



Superadio Dynamometer equipped with phones and plug. Price \$120. (Patents Pending)

Measures Amplification Factor, Plate Impedance and Mutual Conductance of any tube. No curves, no calculations.

### Tube Manufacturers

Improve your product. A uniform output can be obtained if you use the Superadio Dynamometer.

### Jobbers and dealers

The superadio is direct reading and tests 3 tubes per minute. Write for discounts.

**SPECIAL MODEL \$30**  
S-2 AMPLIFIER

To be used with Dynamometer and loud speaker in place of phones

**Just out—The new Superadio B-Battery Eliminator.**

## De WITT-La FRANCE CO., Inc.

54 Washburn Ave., Cambridge, Massachusetts

Boston Representative:

Martin, Hartley & Dewitt Sales Co., 99 Bedford St.

Chicago Representative:

William A. Welty & Co., 36 So. State St.

This is a good time to subscribe for

### RADIO BROADCAST

Through your dealer or direct, by the year only \$4.00

Doubleday, Page & Company

Garden City, New York



Cord Tip Adapter No. 1



Spade Tip Adapter No. 2



Sure Tight Connector No. 3

### "McCALL'S" Little Hexagon Family of Sure Tight Connections

(Patents Pending)  
(Used as Favorites the world over)

These neat little sure tight wire terminal adapters and this Sure Tight Connector are the original "McCall" Hex Family of Connectors. Watch for our other Hex Members. Discount to Jobbers. Price 10c each

Manufactured by

The McCall Novelty Co.  
631 West Edwards St.  
Springfield Illinois

**I**F you like this magazine with its coated paper and enlarged size—then why not subscribe and get it regularly—by the year, \$4.00, Six months, \$2.00.

Doubleday, Page & Co.  
Garden City New York

### R383. RESISTORS RESISTORS.

*QST.* Oct. 1925, pp. 25-28.

"High Frequency Resistance Standards," J. M. Clayton. In measuring frequencies above 2000 kc. the ordinary resistance units are inaccurate, either adding inductance, capacity, or both to the circuit being tested. A new form of resistance made of magnesium wire is described, which can be used for much higher frequencies with extreme accuracy. The method of construction is given. Diagrams illustrate method of mounting and adjusting.

### R343. ELECTRON TUBE RECEIVING SETS. RECEIVER, SHORT-WAVE.

*QST.* Oct. 1925, pp. 33-36.

"Short-Wave Receivers," R. R. Batcher. *Grebe CR-17.* Valuable pointers concerning construction of short-wave receivers are brought out in this discussion, with particular reference to the *Grebe CR-17.* A short-wave tuner chart is used for inductance and capacity calibrations.

### R356. TRANSFORMERS. TRANSFORMERS.

*QST.* Oct. 1925, pp. 37-39.

"Transformers and Reactors in Radio Sets," R. H. Chadwick. Part II.

Audio-frequency transformers are discussed, more or less theoretically, with particular emphasis on the amplification factor at various frequencies. At low and high values of frequency, the amplification is less, due to effects noted in diagram, Fig. 10. Filter reactors are used for the purpose of introducing opposition to the flow of alternating current. Depending upon the circuit they are to serve, their construction will be determined. The discussion brings out the general principles involved in reactor design.

### R110. RADIO WAVES. SHORT WAVES, PHENOMENA OF.

*Radio News.* Oct. 1925, pp. 410ff.

"The Behavior of Radio Waves," Dr. E. F. W. Anderson.

Little is known concerning the radiation of energy from antennae. Our conception of the ether and the electron is more or less vague at present. Experience points towards the fact that short waves are reflected according to the Larmor Theory of propagation, herein described. A new phenomenon was noted recently, namely that of horizontally polarized waves when sent from a horizontally mounted multiple-tuned loop. The plane of polarization changes as the wave progresses. The method used for analysis, and the construction of the loop, are shown in photographs.

### R504. GERMANY. GERMAN RADIO DEVELOPMENTS.

*Radio News.* Oct. 1925, pp. 412ff.

"Radio in Germany," Dr. E. Nesper. Radio developments in Germany have been making great strides, as is indicated by the interest shown in recent radio exhibits. Since September 1st, the German radio laws and regulations have been greatly modified, so that experimenters have about the same range of freedom that we, here in America, enjoy. Interest in broadcast programs is keen. The broadcast system is owned by the Postal Company and licenses are issued for receivers. Photographs of several home-made receivers are shown.

### R550. BROADCASTING. SUPER STATIONS.

*Radio News.* Oct. 1925, pp. 418ff.

"Super-power Broadcasting." This article describes the new wgv 50-kilowatt broadcasting station. The accompanying photographs give a very clear idea of the size and scope of the equipment. The circuits used in the many transmitters at Schenectady are of the master oscillator type. Much of the work is experimental, for little is known regarding the use of super-power on the various frequencies. The stations are operating primarily for the purpose of learning more about the "attenuation constant" of transmitters.

### R800(535.3) PHOTOELECTRIC PHENOMENA PHOTOELECTRIC CELL, ITS USE.

*Radio News.* Oct. 1925, pp. 426ff.

"The Vacuum Tube and Photoelectric Cell," General G. Ferrié.

A method whereby the photoelectric cell is used in conjunction with three and four electrode tubes, to detect and amplify extremely small currents set up by light waves (particularly ultra-violet), is here given. This principle has many applications in astronomy. It is also used in determining the period of a pendulum, a mirror being attached to the swinging arm, and light reflected into the cell.

### R130. ELECTRON TUBES. VACUUM TUBES.

*Radio News.* Oct. 1925, pp. 434ff. *Detecting and Amplifying*

"Hard Tubes and Soft Tubes as Amplifiers and Detectors," Prof. C. Bazzoni. Part I.

An elementary but nevertheless very thorough and comprehensive discussion on the operation of vacuum tubes is presented. Emission, space charge, degree of vacuum and the action of gas atoms and electrons, determine detector and amplifier action in vacuum tubes. Graphic diagrams help to form a mental picture of the action within the tube.

### R381. CONDENSERS. CONDENSERS, S.L.F.

*Radio News.* Oct. 1925, pp. 447ff.

"Does a Straight Line Frequency Condenser Exist?" S. Harris.

The question of obtaining straight line frequency calibration curves with a so-called straight line frequency condenser, is a point much discussed. The author shows the relation between condenser capacity and coil at various frequencies. There is practically no deviation from the straight line even with coils of a large distributed capacity when connected to a straight line frequency condenser. So for all practical purposes the instrument does exactly what it is supposed to do.

### R149. RECTIFICATION. FILTERS.

*Radio News.* Oct. 1925, pp. 452ff.

"All About Filters," E. W. Berry. In order to obtain a source of good direct current for plate supply, either a generator or alternating current rectifier is often employed. Both need considerable filtering. The article describes in detail the effect of choke coils and condensers in a circuit. Concrete examples serve to illustrate the points brought out. A series of graphs show the result of tests made with series, parallel, and series-parallel connections of chokes and condensers. A thorough presentation of the subject for experimenters.

FOR—  
REAL ENJOYMENT



**Burns** ★

LOUD SPEAKER

Assures remarkable clarity of tone with maximum volume—reaches full range of musical scale and gives a faithfulness of reproduction that equals hearing the original. New Concert unit is of substantial size and is designed along scientific lines.

Burns Horns are of distinctive design and have special amplifying properties which combined with the pleasing tone of the Concert Unit give most remarkable results.

PRICES

- No. 205B—With black flare..... \$22.50
- No. 205D—Mahogany tinted flare..... 25.00
- No. 205P—Mother-of-pearl flare..... 30.00
- No. 100 —Medium phonograph unit.... 10.00
- No. 120 —Concert phonograph unit.... 12.00

Manufacturers

**American Electric**  
COMPANY

Chicago, U. S. A.



CONCERT UNIT

We Have Specified Parts  
TO BUILD THE NEW 6 TUBE  
**Silver - Marshall**

“MODERN BROADCAST  
RECEIVER”

Model 1926

When building this receiver be sure you use only the parts specified and you will not only have the satisfaction of possessing the finest receiver yet developed, but you will be a year ahead of all others.

- 3—S-M 311 .00035 S. L. F. Condensers
- 3—4 in. Na-ald moulded dials
- 3—S-M 515 Coil Sockets
- 2—S-M 112A Inductances
- 1—S-M 110A Inductances
- 6—S-M 510 Sockets
- 1—Carter 6-ohm imp. Rheostat
- 1—Central Laboratory 500,000 ohm Modulator
- 3—Muter or Daven Resistance couplers complete
- 1—Carter 101 Jack
- 1—Carter 102A Jack
- 1—Benjamin On-off Switch
- 1—.002 M. F. Condenser
- 2—S-M .5 M. F. By-pass Condensers
- 1—7 x 24 Drilled, Sanded and Engraved Panel
- 1—7 x 23 Oak Base Board, Bus-bar, Screws, Lugs, etc.
- 1—Belden 5-lead color cable

Complete Parts \$49.50  
as Specified, Only . .

Wired and Ready to Use \$8. Extra

EXTRAS

- Daven MU-20 Tubes / \$ 4.00
- Daven MU-6 Power Tube / 5.00
- Western Electric 540-A.W. Cone Speaker / 24.50

WE ALSO CARRY ALL THE PARTS FOR THE

**Hammarlund**  
**Roberts**  
Receiver

Endorsed by ten leading Radio Engineers

This is the circuit described, illustrated and listed on pages 73 to 78 in  
NOVEMBER RADIO BROADCAST

The engineers of the leading manufacturers who make these parts endorse the operation of the Hammarlund-Roberts Receiver only when it is constructed with these specified units which the designers have found to coordinate most efficiently with one another.

Order from this list and we guarantee you prompt delivery.

- Unit No. 1. 2 Rauland-Lyric Transformers .....@ \$9.00 \$18.00
- Unit No. 2. 1 Hammarlund “Midget” Condenser 5 plate, 16 mmfd. ....@ 1.80 1.80
- Unit No. 3. 2 Hammarlund .0005 mfd. Model “C” or S. L. F. Condensers .....@ 5.00 10.00
- Unit No. 4. 1 Set Hammarlund-Roberts Coils .....@ 6.00 6.00
- Unit No. 5. 2 Na-ald “Super DeLuxe” 4 in. Bakelite Dials .....@ .75 1.50
- Unit No. 6. 5 Na-ald “DeLuxe” Sockets .....@ .75 3.75
- Unit No. 7. 1 Na-ald K3844—1 3/4 in. Dial .....@ .20 .20
- Unit No. 8. 4 Amperites No. 1-A .....@ 1.10 4.40
- Unit No. 9. 5 Prs. Union Phone Tip Jacks, per pair @ .25 1.25
- Unit No. 10. 1 Carter 25-ohm “Imp” Rheostat .....@ 1.00 1.00
- Unit No. 11. 1 Carter Single Circuit No. 101 “Hold-Tite” Jack, .....@ .70 .70
- Unit No. 12. 1 Carter “Imp” Battery Switch .....@ .65 .65
- Unit No. 13. 1 Dubilier Type 640-G .00025 mfd. Grid Condenser .....@ .50 .50
- Unit No. 14. 1 Dubilier Type 640 .002 mfd. Fixed Condenser .....@ .45 .45
- Unit No. 15. 1 Dubilier Type 640 .006 mfd. Fixed Condenser .....@ .80 .80
- Unit No. 16. 1 Durham Metallized Resistor .....@ .40 .40
- Unit No. 17. 1 Hammarlund-Roberts Foundation Unit (contains engraved bakelite Westinghouse Micarta panel, drilled bakelite sub-panel, metal brackets and wire) @ 9.40 9.40

HAMMARLUND MFG. CO., INC.

Complete Parts as specified . . \$57.50

Cabinet \$10.00 extra

Booklet “How to Build the Hammarlund-Roberts Receiver” with complete diagram and illustrations—Postpaid, \$.25.

We Also Have Specified Parts For The New  
L. C. 1926 MODEL RECEIVER

HEINS & BOLET, 46 Park Place, New York

ANNOUNCING

A Complete New Line of

ADJUSTABLE  
ENCLOSURES - CONSOLES  
AND TABLES

(PATENTS PENDING)

Panels adjustable to length, depth, width, and location, upright or tilted, all quickly and easily in one STANDARDIZED MODEL, open and closed of many designs. Beautiful inlaid WOODCRAFT PANELING. Built in Loop, inside Antenna and other new Pat. Pdg. features. Large production at factory prices, etc.

WATCH for Them! NEXT ISSUES Wait for THEM!

Better still, write for literature to Factory and Sales Department.

DETROIT WOODCRAFT CORP. ★

The Original

2262-4 Hendric Street  
Detroit, Mich.

The Adjustable

“MAKES YOUR RADIO LOOK LIKE A RADIO AND UP-TO-DATE”

Product of over 30 years' Experience



## The Favorite Voice of Radio in All Tongues

**T**O hear an Amplion in comparison with any or all other loud speakers is to appreciate at once why Amplions are the largest selling radio reproducers throughout the world—favorites of music lovers in all lands.

The actual originators and oldest makers of loud speakers, Alfred Graham & Co., London, England, evolved The Amplion. Its superbly life-like

reproduction and supreme clarity on all notes give eloquent testimony to Graham's more than thirty years' experience in sound reproduction.

Bring out the full musical quality of your set with an Amplion loud speaker or console unit. The prices are \$12 to \$42.50. All Amplions are completely equipped with cord and panel plugs. Write for the "Amplion Pedigree" and dealer's address.

### THE AMPLION CORPORATION OF AMERICA ★

Executive Offices: Suite L, 280 Madison Ave., New York City

Canadian Distributors: Burndept of Canada, Ltd., Toronto

Associated Companies and Agents: Alfred Graham & Co., London, England, Patentees; Amplion Corporation of Canada, Limited, Toronto; Compagnie Francaise Amplion, Paris, France; Compagnie Continentale Amplion, Brussels, Belgium; Amalgamated Wireless (Australasia), Ltd., Sydney and Melbourne; British General Electric Company, Ltd., Johannesburg and Branches; Indian States and Eastern Agency, Bombay and Calcutta; C. J. Christie E. Hijo, Buenos Ayres; David Wallace & Co., Valparaiso; Mestre & Blatge, Rio de Janeiro; F. W. Hammond & Company, London and Tokio.

# AMPLION

BLUE PRINTS FOR THE "ARISTOCRAT" RECEIVER DESCRIBED BY ARTHUR H. LYNCH IN THE NOVEMBER MAGAZINE CAN NOW BE OBTAINED AT YOUR RADIO DEALER. IF HE CANNOT SUPPLY YOU SEND US HIS NAME AND ADDRESS.

Price one dollar for complete set.

## BOOK REVIEW

### A History of Radio Men and Their Contributions to Radio Progress

RADIO: BEAM AND BROADCAST. By A. H. Morse, Published by Ernest Benn, Ltd., London. In New York, by D. Van Nostrand Company. 186 pages. \$4.

**T**HIS recent book on radio is well worth while the attention of any who expect to do developmental work in radio, or in any of its allied fields. While it is entirely different from what we had expected to find, it proved to be of sufficient interest that we stayed with it on the first reading until the last page had been covered.

Instead of being as we had supposed, a book written more or less in the manner of a text, it proved to be an interesting and continuous history of the art of radio as a whole, having no special connection with either beam or broadcast methods of communication. The author's intentions are perhaps best given in his own words. Says he in the introduction: "Within the last few years, the radio field has been invaded by many thousands of persons who know nothing of its evolution, and are therefore sometimes unable to distinguish between what is new and what is old. The consequence is that they waste much time and money in re-inventing old devices and in developing others to circumvent imagined patents, or inventions, long since in the public domain. The case of the spider-web coil may be cited as an example. This will be found to have been illustrated and described several years before the Great War, but was heralded as a novelty two or three years ago. It is one of the author's objects to help to create the perspective of these newcomers, and it is hoped that this book will be of some assistance to British and American patent agents' attorneys (new to the art), inventors, experimenters, journalists, radio enthusiasts, and 'why men' generally, on both sides of the Atlantic.

"The evolution of the radio art is traced herein mainly through the Patent Office records of inventions in use to-day, or their lineal forebears. As a consequence, many inventions of great merit and one time promise, receive little or no mention; and except in a few cases where inventions are cited merely as evidence of the contemporary knowledge of the art, a selection has been made, not by the author but by the test of utility. It may be observed that this test has proved too much for some of the most heralded inventions."

The first chapter of the book briefly relates the accomplishments of the early workers in the radio field, starting with Christian Huygens, who first propounded the undulatory theory of light in 1678, and ending with the year 1912. The author has been at a deal of trouble evidently in consulting original writings, and has given in an interesting manner a story of the high spots of radio's development during this period. To indicate the scope of the material given, there is a note that in 1843 Professor Joseph Henry succeeded in magnetizing needles two hundred and twenty feet distant from his energizing apparatus. In the opinion of one of America's foremost physicists, these experiments of Henry really constitute the first disclosure of radio communication, but they apparently were not appreciated as such by Linsely, and his work had no important commercial outcome. In 1879, Professor Hughes, an Englishman, succeeded in sending radio signals a distance of about sixty feet. Among those present were some of the most noted English scientists and engineers,

# A Hookup for Dealers that Eliminates Interference



When a Radio Dealer "hooks up" with the House of Hommel—he is assured of the closest co-operation and of a dealer service unexcelled, if even equaled, by any other radio jobber,—all of which means greater profits for Hommel Dealers.

The numerous user inquiries referred to their dealers—their policy of wholesaling only—the large stocks of reputable radio equipment carried at all times for immediate shipment to dealers—their inspection and repair department—their modern display room,—are but a few of the many features of Hommel Service that are responsible for the reputation and success of the Hommel organization to-day.

Hommel's Encyclopedia No. 466-B tells the story in detail—write for your copy to-day.

WHOLESALE

EXCLUSIVELY

## LUDWIG HOMMEL & CO

929 PENN AVENUE



PITTSBURGH, PA.



### Charge your battery OVERNIGHT

Model "A"—for radio "A" and 6 volt automobile batteries. A.C. line, 40 to 60 cycle, 110-120 volts. Battery—6 volts 6-8 amperes. Comes complete with cords, plug and leaded clips. **\$18.00**

Price.....East of the Rockies

Model "A-B"—for charging radio "A" and "B" batteries *simultaneously*. A.C. line, 40 to 60 cycle, 110-120 volts. Battery—"A," 6 volts 3-4 amperes; "B," 48 to 96 volts in series, 1/10 ampere, up **\$22.00**

Price.....East of the Rockies

**Pays its cost in a short time  
by what it saves you**

Ask your dealer to show it to you—or write for booklet.

## You can do it right in your own home with the



### RADIO BATTERY CHARGER

THE ordinary charger uses only half the electric current wave.

Ful-Wave, by a new and better principle, uses the full electric wave.

Because of this and other reasons Ful-Wave takes only about half the usual time to charge a battery.

—Uses approximately half the current cost to do the work.

There's no charger like it. Quiet, dependable, factory sealed. It needs no adjustment, no water, no chemicals.

Its service is absolutely guaranteed. See it and compare it—at your nearest dealer.

**LIBERTY ELECTRIC CORP. of NEW YORK - 342 Madison Ave. New York**

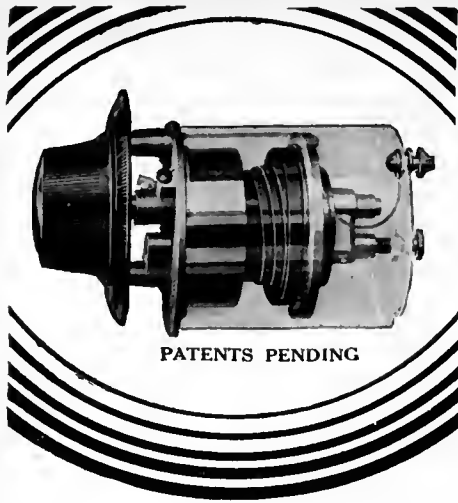

## The First radical improvement in radio SLF condensers

**A**T LAST! A new era in variable condensers. With practically all other radio parts undergoing constant improvement the limitations and deficiencies of the old-style multiple plate condenser have handicapped progress.

But now—professionals recognize in the new FURNELL Condenser—based on an entirely new and simplified principle—the most practical and efficient condenser ever designed for straight-line Frequency tuning. It is the only condenser of its type on the market and experts agree that:

*"It's the most important step forward that has yet been made in its field."*

Simplicity is the keynote of progress. The FURNELL replaces open multiple plates with only two shielded plates, each coiled in the form of an evolute. Simple—sound—durable. Assures clean-cut separation of stations, tone clarity and scientific precision heretofore impossible. Dust-proof, moisture-proof damage-proof.

Each condenser complete with special 4" Bakelite 360° Dial and enclosed in a transparent Dust-proof case.

Exclusive Sales Franchises Available to Reputable Jobbers in Locations Still Open.

Write for Literature ★

FURNELL MANUFACTURING CORP.  
24L Scott St., Newark, N. J.

# FURNELL

360° TAPER COIL  
CONDENSERS

but Hughes apparently did not really appreciate how important and real his work was, and so was discouraged by the comments of a fellow scientist. They took the romance out of Hughes's experiments by telling him that the ordinary laws of mutual induction might be used to explain all of his experiments. In 1899, Sir William Crookes, commenting on Hughes' work, said: "It is a pity a man who was so far ahead of all other workers in the field of wireless telegraphy should lose all the credit due to his great ingenuity and prevision."

Of course every radio enthusiast now knows that in 1888 Professor Hertz succeeded in showing that electro-magnetic waves and light waves are the same thing, and that he actually did carry on radio experiments in his laboratory with such skill and perseverance that one may read in his laboratory reports a description of practically all of the radio schemes which it has taken us thirty-five years to develop. For those who have not read Hertz's book, a real treat is in store, for one may see pictures and read about experiments disclosing the whole idea of radio beam communication, which many people believe originated in the comparatively recent experiments of Marconi.

The author takes us through the work of Branly (who recently received the Nobel prize for the work he carried out during this period), Thomson, Lodge, Popoff, Rutherford, Marconi, and Fessenden. In 1906 DeForest put the B battery in the plate circuit of the Fleming valve and, in 1907, introduced the third electrode, giving us the now famous audion. In the same year, in Italy, Bellini and Tosi were showing the possibilities of direction finding by radio, and in Germany von Lieben and Reisz were experimenting with the three electrode tube. This brings us up to 1912, when the regenerative circuit was patented in England by Franklin, in Germany by Meissner, and in America by Armstrong. Here the author expands greatly his previously brief presentation of the subject to show that DeForest should be credited, at least in America, with the regenerative and oscillatory features of the audion. He cites the recent decision of the United States Court of Appeals of the District of Columbia, which gives precedence regarding the invention of the oscillating audion to De Forest, whereas the public is accustomed to think that Armstrong was the first to develop this idea.

As we read over this part of the book, and again read over the comparison of the work of Fleming and De Forest, we were urged to look up the former connections of the author, and found on the title page that he was formerly associated with De Forest as superintendent of one of the De Forest wireless telegraph companies. In reading certain parts of the book this fact should be kept in mind.

Chapters II and III deal with radio between 1912 and the present time, and the prediction as to future development. It is not apparent why the prediction should be inserted in Chapter III, as this chapter is followed by others on such subjects as the Poulson arc, broadcasting, regeneration in reception, the triode as generator, one on beam and short wave radio, ending up with the ninth chapter entitled "Conclusion."

An interesting paragraph in the final chapter calls our attention to the fact that many inventors fail to get the credit which is due them. In this place the author writes as follows: "Prior to 1896, Preece had in operation a system of inductive wireless telegraphy, and it was just when he was smarting under the failure of this system to provide communication with East Goodwin lightship, that Marconi came to him with a letter of introduction from Mr. A. A. Campbell-Swinton. Both Lodge and Rutherford had already shown that wireless telegraphy was practicable, and by the same essential

Today  
-in every  
good set!



"I'm a MASTER OPERATOR"

AMPERITE never distinguishes between a novice and an experienced operator for the wonderful clarity and full, rich tones it makes possible. Just pull the switch and each individual tube does its utmost to outdo the other tubes. The "Self-Adjusting" rheostat that takes the guess out of tube control. Used in all popular construction sets. Price, \$1.10.

There is an AMPERITE for every tube

Write for free hook-ups

Radiall Company ★

Dept. R. B.—1 50 Franklin St., N. Y. City

# AMPERITE

REG. U.S. PAT. OFF.

The "SELF-ADJUSTING" Rheostat

O. Henry  
Kipling  
Conrad

Three names that  
just about cover  
modern literature.

AT ALL BOOK STORES

**WRITTEN 2-YEAR GUARANTEE**

**Battery Prices SMASHED!**

**To Consumers Only**  
Here is a real battery quality, guaranteed to you at prices that will astound the entire battery-buying public. **Order Direct From Factory.** Put the Dealer's Profit in your own pocket. You actually save much more than half, and so that you can be convinced of true quality and performance, we give a **Written 2-Year Guarantee.** Here is your protection! No need to take a chance. Our battery is right—and the price is lowest ever made. Convince yourself. Read the prices!

Auto Batteries		Radio Batteries	
6 Volt, 11 Plate, \$9.50	6 Volt, 100 Amp. \$9.50	6 Volt, 13 Plate, \$11.50	6 Volt, 120 Amp. \$11.50
12 Volt, 7 Plate, \$13.00	6 Volt, 140 Amp. \$13.00		

**Buy Direct—Send No Money**  
We ask no deposit. Simply send name and address and style wanted. Batteries will be shipped same day we receive your order Express C.O.D. subject to your examination on arrival. Our guarantee accompanies each battery. We allow 6% discount for cash in full with order. You cannot lose! Send your order today—NOW!

**ARROW BATTERY CO.**  
Dept. 10. 1215 So. Wabash Ave., Chicago



# TUBE SERVICE

Your set is no better than your poorest tube  
They must be uniform

A good tube must have:

1. Good Tone Quality.
2. Impedance not too high.
3. Low filament consumption.
4. Long life.



### Pingree Tube Characteristics

Plate impedance 8500—10,000 ohms.  
Amplification factor 8-9.  
Filament consumption .25 amp.  
Filament voltage 5.0 volts.  
Plate voltage 16v-90v.

A—TYPE \$2.00

## PROTECTION

Each tube is tested rigidly on a Superadio Dynamometer before shipment.

## TRIAL OFFER

Try these tubes 10 days at our expense. If they are not what we claim, we will gladly refund your money.

**PINGREE RADIO SERVICE, INC.**

170 Summer Street

Boston, Mass.

Dealer inquiries solicited

# On to Success in RADIO!



Mr. R. L. Duncan  
Director of the  
Radio Institute  
of America

**R**ADIO is a profession well worth following. The work is interesting—fascinating. The pay is high. The demand for new men—skilled men—is strong.

You can embark, right now, on a successful career in radio. With a few months study under the expert instruction of the Radio Institute of America you can pass your U. S. Government Commercial or Amateur Radio License Examination and be ready for your first real radio job.

## Study in spare time

There's no need to give up your present work. Study at home in spare time. If you really want to make a success in radio, fill in and mail the coupon to the Radio Institute of America for information on the finest theoretical and practical radio courses offered today.

## RADIO INSTITUTE OF AMERICA

Formerly Marconi Institute Established in 1909

328 Broadway

New York City

## 5 WIRE BATTERY CABLE

with heavy leaded terminals, soldered to stay. Conductors are insulated with rubber, preventing short circuits and blown tubes.

Cable with storage battery clips	\$1.00
Without clips	.75
Without terminals	60

Each wire is coded so that wrong connections are impossible. PREMIER 20 foot extension cord with new connector, \$1.75, longer lengths also. PREMIER JR., \$1.25.

Take your loud speaker anywhere.

At your dealer or write us

**CRESCENT BRAID CO., Inc.** ★

Providence

Rhode Island

-----CUT HERE-----

RADIO INSTITUTE OF AMERICA  
328 Broadway, New York City

Please send me full information about your Home Study Course of radio instruction.

I am interested in the complete course, including code instruction, which qualifies for the U. S. Government Commercial or Amateur Radio License.

Name.....

Address.....

City..... State.....

*The moustache, the beard and the bustle are hopelessly out of date. But no more so than the obsolete slow 2-ampere battery charger!*  
**Buy nothing but an up-to-date 5-ampere charger!**

*The New Improved*  
**5 AMP. A & B**  
**GOLD SEAL**  
**HOMCHARGER**  
**\$19.50**



Over 500,000 already in use

**Modern-Fast-Efficient!**

**N**OW you don't have to wait for days while your battery charges. The new 5-ampere **GOLD SEAL HOMCHARGER** charges A or B batteries three times as fast as last year's slow chargers - - - it fully charges the average radio battery **OVERNIGHT!**

This year when you buy a battery charger, be sure it is a modern fast charger - - - one that charges at 5-amperes. To be absolutely sure, insist on the 5-ampere **GOLD SEAL HOMCHARGER.**

*Free* Write for new edition of our interesting 16-page booklet "The Secret of Distance and Volume in Radio." ★

**THE KODEL RADIO CORPORATION**  
 505 EAST PEARL ST. CINCINNATI, OHIO



This is a good time to subscribe for  
**RADIO BROADCAST**  
 Through your dealer or direct, by the year only \$4.00  
**DOUBLEDAY, PAGE & CO. GARDEN CITY, NEW YORK**

**FREE RADIO STAMPS**

616 beautiful copper etched American, Canadian, and European stamps, each with the call letters of a station, **FREE** with Ideal 48-page Radio Stamp Album and Log. Also contains complete list of stations both alphabetically and by call letters. As you hear new stations, just put the proper stamps in your album. Album and stamps become a permanent and interesting record of the stations you receive. You and your children will enjoy it. Complete album, 5"x11", heavy board covers, \$1 plus postage.

**Send No Money**

Just pay postman after album and stamps arrive. We prepay postage if you prefer to pay with order. **MONEY REFUNDED if not DELIGHTED.** Send order today—**NDW.** Postal will do. **IDEAL CO., Dept 3371, 366 Wrigley Bldg., Chicago**

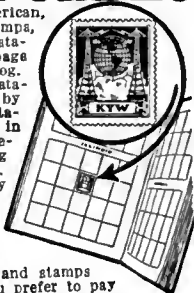

Why not subscribe to *Radio Broadcast*? By the year only \$4.00; or two years, \$6.00, saving \$2.40. Send direct to Doubleday, Page & Company, Garden City, New York.

**Big Money In Radio**

Demand for high pay radio men is so great that a big Kansas City wholesale concern is now fitting men free to get into the radio business for themselves and make \$60 to \$200 a week without any capital invested. Select territory open. Send to-day for free catalog and amazing offer. Write direct to Mr. H. J. Salzw, Standard Radio Co., 1426 Walnut St., Kansas City, Mo.

method that was used by Marconi, but apparently they did not see, or were not interested in, its commercial potentialities, or were too much engrossed in other activities to endeavor to exploit them. This circumstance has no doubt contributed to the fact that to-day the layman regards 'Marconi' and 'Wireless' as interchangeable terms, while the credit which is due to Hughes, Lodge, Popoff, Braun, Fessenden, Stone, and others, is in danger of being forgotten, except by technicians."

The author's views on monopoly are especially interesting in light of the investigation now being carried on by the Federal Trade Commission regarding the activities of the Radio Corporation of America. Quoting Sir William Crookes, regarding the activities of the Marconi Company, the author says: "The whole effect of the operations of the Marconi Company has been to check and really stop the growth of wireless telegraphy as a convenience to navigators as well as a commercial undertaking." This comment, it is to be borne in mind, is made regarding the British Marconi Company, and quite possibly Sir William Crookes might not have expressed the same thing regarding an American monopoly.

In the appendix, which occupies the second half of the book, there are given copies of the important patents which have been granted in the radio field since its inception.

The material given in the book, although not presented in very carefully thought out manner, is extremely interesting, and is well worth the attention of anyone who wishes to appreciate the development of radio and its growth.

J. H. MORECROFT

### HIGH-SPEED FADING

**M**UCH experimental work is being carried out by British "hams" with a view to finding some feasible explanation, and a suitable cure, for high-speed fading. This phenomenon manifests itself, at nearby receiving stations, by distortion and very ragged modulation. As an example of the far-reaching effect of high-speed fading, it is interesting to cite a case experienced by that well known British "ham" Mr. Gerald Marcuse, who operates station 2NM, and whose telephony transmissions are often heard in this country on 6663 kc. (45 meters). He states that, while his short-wave telephony tests, carried out on Sunday evenings with Iraq and India, are reported as being received with crystal purity in those countries, nearby listeners (within a hundred miles or so) write and tell him that his modulation is terrible; nothing can be received intelligibly.

Often this condition is far less troublesome during the hours of daylight, and in this instance we might mention an interesting fact about the short-wave transmissions of KDKA. Listeners in the city of Washington state that it is impossible to receive this station's short-wave emission with anything like good quality during the night hours. However, during the daylight hours, the Pittsburgh programs are perfect.

High-speed fading is only one of the many short-wave telephony problems with which the amateur has to cope, and it is hoped that the recommendation by the recent Washington Radio Conference, that amateurs should be permitted the use of a short-wave band for telephony experiments, will materialize. Already, we understand, the United States Navy Department have concentrated their attention in an effort to overcome this and other short-wave difficulties. If, then, the American amateur is permitted the use of the short waves for his radio vocal efforts, it is more than likely that the data already collected by the Navy Department, will be greatly supplemented, and at least, the many short-wave problems greatly mitigated.

Model 2 RK, antenna coupler and regenerative tuner for Robert's, Radio Broadcast Knock-out, etc.

\$7.50

# CLAROTUNER

Model TCH, for straight three circuit hook-ups and Radio World's Thoroughbred

\$4.50

FOR THE "KNOCK-OUT" BECAUSE—

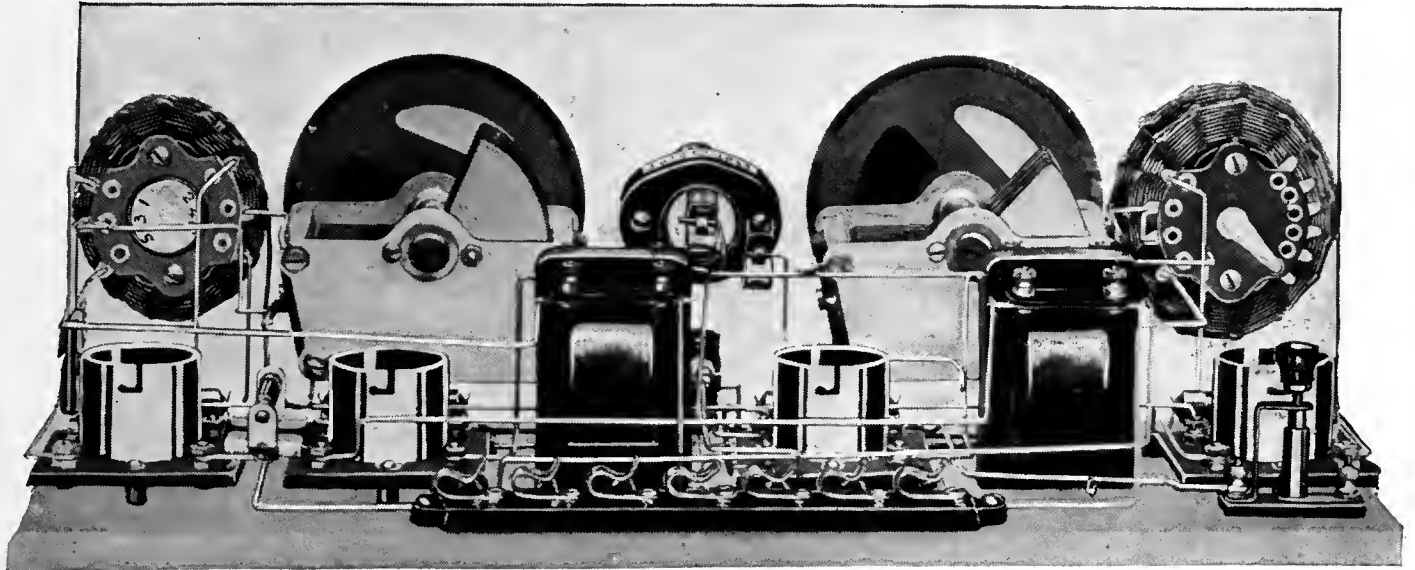

Knock-out Receiver using model 2 R.K. Clarotuners and Clarostat as tone modulator

- they are easier to mount (requiring only one hole)
- they are easier to connect (all terminals are designated)
- the antenna coil is tapped, making for greater selectivity
- the regenerative tuner is easier to control because its fixed tickler arrangement affords a more even approach to the point of maximum amplification.

If your local dealer cannot supply you, send your remittance direct to us.

**AMERICAN MECHANICAL LABORATORIES INC.**  
285 North Sixth Street, Brooklyn, N. Y.



CLAROSTAT, the heart of the Clarotuner, is the most accurate variable resistance ever placed on the market. It has a continuously variable resistance ranging from practically zero to five million ohms—and all this without a single abrupt step!—\$2.25.

The COMPLETE radio guide—96 pages, compiled by radio experts and crammed full of interesting data for radio enthusiasts. From the first to the last page, it's a review of the newest, finest in radio; EVERYTHING listed is standard, nationally known, merchandise; Sets parts, equipment, apparatus, cabinets,

*Yours Free*

*Now Send for IT*

etc. 1-3-5 and multi-tube circuits, kits as well as ready-built outfits.

**FREE EXAMINATION**

Everything you order from WRS is sent with the privilege of free examination. You do not risk a single penny, you MUST be satisfied or the sale is NOT complete!



Patented Nov. 18, 1924

*Windsor Loudspeaker Console*

## For EVERY Radio Set

A stunning piece of furniture that restores order in the room where you have your Radio! No more cluttered table-tops, nor litter of equipment under-foot.

No unsightly horn in evidence, either! This console has its own loudspeaker, in-built. It's out of sight, but with very apparent tonal superiorities. For it has the highest-developed type of unit. With horn built of special non-vibrating, extra-hard material. Produces clear non-vibrant tone.



**Non-Vibrant Horn**  
The clearest tone producer on the market. Made of special composition which defeats vibration.

There's ample room for everything; space for A and B wet batteries—or battery eliminator—and for a charging outfit, too.

Finished in mahogany, or walnut color. Dainty design of parquetierie on two front panels. Top, 38 in. x 18 in.

Additional pattern No. 128 (Special for Radiola No 125) in two-tone finish. Top, 21 in. x 31 in. Fitted with doors for access to control switches of combination eliminator-charger.

The price, forty dollars, is for the complete console and includes the loudspeaker horn and unit. Thousands of dealers are showing this artistic addition to home radio equipment.

Rear View—Set Hooked Up



Price, \$40  
West of Rocky Mts., \$42.50

**Windsor Furniture Co.**

1420 Carroll Ave.  
Chicago, Ill.

## WHAT OUR READERS WRITE US

*What Some Famous Radio Men Think of the New "Radio Broadcast"*

HERE are a few extracts from letters of radio men known to all of our readers, telling us what they think of the new RADIO BROADCAST.

DE FOREST PHONOFILMS, INC.  
NEW YORK CITY

*Editor*, RADIO BROADCAST,  
Doubleday, Page & Company,  
Garden City, New York.

SIR:

I have just had time to look over the last issue of RADIO BROADCAST. I am highly pleased with its appearance and contents. The new is certainly a distinct advance over the old style.

Mr. Thompson certainly succeeded in making another live, interesting story on the "Audion"—full of the personal touch which surely appeals to the average reader. Congratulations and continued success to RADIO BROADCAST.

Very truly yours,  
LEE DEFOREST.  
President

DEPARTMENT OF COMMERCE  
WASHINGTON

*Editor*, RADIO BROADCAST,  
Doubleday, Page & Company,  
Garden City, New York.

SIR:

The November number of RADIO BROADCAST makes a very fine appearance in its new form. . . . I wish you the best of fortune in the further development of your very excellent periodical.

Very truly yours,  
J. H. DELLINGER.  
Physicist.

RADIO CORPORATION OF AMERICA  
NEW YORK CITY

*Editor*, RADIO BROADCAST,  
Doubleday, Page & Company,  
Garden City, New York.

SIR:

On my return to the city, after a week's absence, I had brought to my attention the new RADIO BROADCAST. . . . It is a well prepared magazine and should meet with the public's approval.

Very truly yours,  
J. G. HARBORD.  
President.

NATIONAL ASSOCIATION OF BROADCASTERS  
NEW YORK CITY

*Editor*, RADIO BROADCAST,  
Doubleday, Page & Company,  
Garden City, New York.

SIR:

I am very happy to see the recent changes in RADIO BROADCAST. It augurs well for a continued advancement in publications dealing with radio. We have always considered RADIO BROADCAST a foremost radio magazine of the country, and hope that it will always continue to be so.

Very truly yours,  
FRANK W. ELLIOTT.  
President.

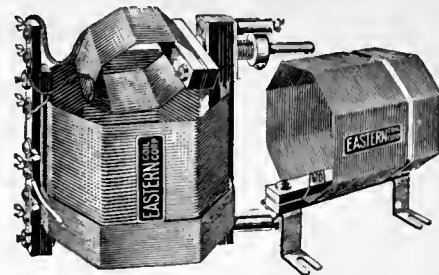

## EASTERN KNOCKOUT COILS TYPE R

Designed in strict accordance with Radio Broadcast specifications and approved for the "Aristocrat" and for all Roberts Knockout Circuits, reflexed or un-reflexed. Latest design—mid-tap on single layer wound N. P. Coil—simplifies neutralization and tuning. Per set, \$8.50

All Eastern Coils are in the efficient low loss *pickle bottle* form of winding, guaranteed incomparable for the BROWNING-DRAKE (Type B-D, \$8.00 per set), O'CONNOR FREQUENCY CHANGER (Type FC Coupler, \$6.00), OSCILLATOR COILS (Type O C), for same, with special .00013 mfd. fixed condenser (\$4.75). THREE CIRCUIT SET (Type 3C Coupler, \$6.00), and for other leading circuits.

At your dealers  
or direct postpaid

EASTERN COIL CORPORATION  
22 Warren Street New York Dept. R. B.



ALL STANDARD TYPES \$2.50

## CLEARTRON

GUARANTEED RADIO TUBES

Why spoil your enjoyment of radio with inferior tubes when Cleartrons are guaranteed to give perfect service—clearer tone, more volume, greater distance and sharper selectivity. Buy quality and service—Cleartrons.

At All Reliable Dealers

Write for free six page tube folder. CT 101A, the original Hi-Mu tube for Resistance-Coupled Amplifiers \$3.00

CLEARTRON VACUUM TUBE CO.

28 West 44th Street, New York City

Factories: West New York, N. J., Birmingham, Eng.

## FOR BETTER RECEPTION

**FIXED RESISTORS**  
**Micamold**  
**FIXED CONDENSERS**

“Made of Mica and Moulded in Genuine Bakelite.”

Capacities of Resistors and Condensers guaranteed within 5% and constant in value.

They are indestructible and Moistureproof.

At all good Radio Stores

**Micamold Radio Corp.**  
 Flushing & Porter Ave.  
 BROOKLYN, N. Y. ★

ACCURACY GUARANTEED  
 -VALUES REMAIN CONSTANT

MOULDED UNDER PRESSURE OF 50 TONS



**RUDYARD KIPLING**



“A set of KIPLING in the home is read by every member of the family. Buy KIPLING’S books.”

**AT ALL BOOK STORES**

**FOR CLEAR, QUIET “B” POWER**



**RADIO Storage “B” Battery**

12 Cells  
 24 Volts  
 Economy and performance unheard of before. Recharged at a negligible cost. Delivers unflinching power that is clear, pure and quiet. Approved and listed as Standard by leading Radio Authorities, including Pop. Radio Laboratories, Pop. Sci. Inst. Standards, Radio News Lab., Lofax, Inc., and other important institutions. Equipped with Solid Rubber Case, an insurance against acid and leakage. Extra heavy glass jars. Heavy rugged plates. Order yours today!

**SEND NO MONEY** Just state number of batteries wanted and we will ship day order is received. Extra offer: 4 batteries in series (96 volts), \$10.00. Pay exp. salesman after examining batteries. 5 per cent discount for cash with order. Mail your order now!

**WORLD BATTERY COMPANY**  
 1219 So. Wabash Ave., Dept. 24 Chicago, Ill.  
 Makers of the Famous World Radio “A” Storage Battery  
 Prices: 6-volt, 100 Amp. \$11.25; 120 Amp., \$13.25; 140 Amp., \$14.00.  
 All equipped with Solid Rubber Case.

**World STORAGE BATTERIES**

Set your Radio Dials at 210 meters for the new 1000 watt World Storage Battery Station, WSBG, Chicago. Watch for announcements.

KDKA - WEA - WGN - WJS - KHL - RGO - KFA - WJY - KOP



# The Best in the World

**No Batteries**  
 are required even to operate the most powerful 10-tube receiver pictured above, if you use the new laboratory type  
**Model A Power Unit**

**One Customer Telegraphs:**  
 “Receiver assembled, performing like a thoroughbred.”

The Amateur or Experimenter with his ultra-modern high-powered receiver is years ahead of Commercial Radio.

It is significant that unsolicited testimonials are constantly being received from even the far corners of the earth, where Norden-Hauck Engineers have furnished the finest radio apparatus known to the art today.

Quotations gladly furnished on radio parts and apparatus having non-infringing uses.

Write for Literature ★

**NORDEN-HAUCK, Inc.**  
 Engineers

1617 Chestnut Street, Philadelphia, Pa.

**RADIO BROADCAST**  
 For February

will be a better magazine than this. Make sure of it by telling your newsdealer to hold one for you—or better still, subscribe through him or direct.

**RADIO BROADCAST**  
 Garden City New York

**This Booklet Resistance Coupled Amplifiers**  
 IN THEORY AND PRACTICE  
 By Arthur B. Cole R.E.  
 sent post-paid on receipt of 10¢ in stamps or coin  
**COLE RADIO MFG. CORP.**  
 BLOOMFIELD, NEW JERSEY



RADIO FANS, a one-year's subscription to Radio Broadcast will cost you four dollars, two years six dollars. Consider this expenditure as being a necessary investment on your part for the future development of your own knowledge of Radio.

**Play Jazz in a week**

on your Buescher Saxophone

You can do it—easy. 3 lessons free with each new instrument give you a quick start. Practicing is fun because you learn so fast. And it will make you popular, in demand, the center of attraction everywhere you go. Always a hit. Even if you have failed with some other instrument, you can learn the simplified Buescher Saxophone. Don't delay. Get into the big fun. Any instrument sent for 6 days' free trial. Easy terms if you decide to buy. Write now for beautiful, free literature. Address:

**Buescher Band Instrument Co.**  
 1218 Buescher Block Elkhart, Indiana



# Centralab Radiohm

## for oscillation control

The Centralab Radiohm gives you perfect oscillation control—enables you to get full efficiency from your radio set.

By controlling oscillation with this little unit, you can hold that sensitive regenerative position which immediately precedes the oscillation point, without distortion or loss of selectivity. Think what a boon to clear, true-tone reception this is!

The Radiohm provides smooth variation of resistance from zero to 200,000 ohms. Ideal for plate circuit control of oscillation. Used as a standard unit in many leading commercial sets. Price: \$2.00.

# Centralab Modulator

## for volume control

This improved type of potentiometer takes the "rough spots" out of volume—smooths out powerful "locals" as well as difficult "DX." It provides noiseless control of tone volume without in any way affecting the tuning of your set. Has a maximum resistance of 500,000 ohms, specially tapered to give smooth, even control from a whisper to full volume—or vice versa—without de-tuning.

Used in the "Silver Six" set! also in audio circuits with any transformers or with Thordarson "Autoformers." Price: \$2.00.

**CENTRAL RADIO LABORATORIES**  
22 Keefe Avenue Milwaukee, Wis

Mail the coupon



# Centralab

**CENTRAL RADIO LABORATORIES 14 Keefe Ave., Milwaukee, Wis.**  
( ) Send me literature describing Centralab controls. Enclosed find \$..... for which please send me the following:  
( ) Centralab Modulator, at \$2.00 each. ( ) Centralab Radiohm, at \$2.00 each.

Name .....  
Address .....

This is a good time to subscribe for

**RADIO BROADCAST**  
Through your dealer or direct, by the year only \$4.00  
**DOUBLEDAY, PAGE & CO. GARDEN CITY, NEW YORK**

# Radio Dealers WANTED!

If you are the type of dealer who hustles after business, who isn't content to wait for trade to come in but who takes sets out to demonstrate, can talk and sell quality merchandise, and knows Radio values, we have a big proposition for you. Are you that dealer?

## 50% Discount to Dealers

We manufacture a complete line of high grade receivers and sell to dealers at 50% discount. We are distributors for more than 225 Nationally advertised lines.

**FREE** Write today for amazing offers, new 112-page catalog and regular monthly catalog quoting below-the-market prices on latest merchandise—all free. Everything in Radio for less.

**AMERICAN RADIO MFG. CO.**  
1426 McGee St., Kansas City, Mo.

## GRID INQUIRY BLANK

Editor, The Grid  
RADIO BROADCAST  
Garden City, New York

DEAR SIR:

I am a subscriber to RADIO BROADCAST and therefore will receive answers to my queries free of charge.

I am not a subscriber and enclose \$1 to cover cost of answers.

NAME .....

ADDRESS .....

G. D.

THE CROSLY RADIO CORPORATION  
CINCINNATI, OHIO

Editor, RADIO BROADCAST,  
Doubleday, Page & Company,  
Garden City, New York.

SIR:

I wish to compliment you on the beautiful copy of RADIO BROADCAST which has just come to my desk. . . . It is certainly attractive, and I feel sure that in its new form it is destined to greater accomplishments than ever before.

Very truly yours,  
POWEL CROSLY, JR.  
President.

## A Remedy for Congestion

SOMETHING will have to be done to reduce the congestion of broadcasting stations, which is probably felt more in New York than in any other city. Even in Europe trouble is being met with in this respect, and it is suggested that some of the British relay stations will have to be closed down to make room in the ether. Here is a reader's suggestion to alleviate the congestion in New York.

Editor, RADIO BROADCAST  
Doubleday, Page & Company,  
Garden City, New York.

SIR:

Regarding the congested condition of available wavelengths for broadcasting, particularly in this vicinity, I would like to state my views in the nature of constructive criticism. I believe that a mistake is being made in granting so many New York stations exclusive Class B wavelengths. There are now nine Class B stations operating in and around this city on seven different frequencies, only four stations dividing time, namely, WOR and WJY on 740 kc. (405 meters) and WGBS and WAHG on 949 kc. (316 meters), and now, another station, WLWL, has been granted a license to operate on an exclusive frequency, 1041 kc. (288 meters). When there is already a shortage of wavelengths, I cannot understand why every new New York station is given its own wave instead of dividing time with some other station, particularly when such fine stations as WCAP and WRC in Washington are compelled to share time. Each of these two stations, I believe, deserves its own wavelength as they both give the highest grade of programs. Here in New York only two stations, WEF and WJZ, are in my opinion rendering the type of service which justifies an exclusive wave.

I have no grievance against any particular station, but I fail to see any good reason for stations WHN, WMCA, and WNYC not dividing time. The latter, especially, could easily rearrange its programs and allow some other station to share its wavelength. At present it is only on the air for three or four hours a day, seldom starting before 7 P. M. and usually signing off by 10:30 or 11 P. M. If these three stations and the new one, WLWL, were put on a part time basis (WEAF, WJZ, WOR, WJY, WGBS and WAHG continuing as at present), New York would still have six Class B channels which, with the Class A stations in operation, should be enough to satisfy any listener. This would leave two waves available for other eastern cities, one of which should be assigned to Washington and the other reserved for future use.

In Chicago, every station divides time with another and I believe this arrangement has been satisfactory to all concerned, while the programs broadcast from that city are in most cases of the highest caliber. If such a plan were put into effect here, while no doubt it would not meet with the approval of the owners of the stations concerned at once, it would enable them to concentrate more on the time they would be on the air and thus furnish better programs.

Yours very truly,  
GEORGE W. CLINCHY,  
New York City.

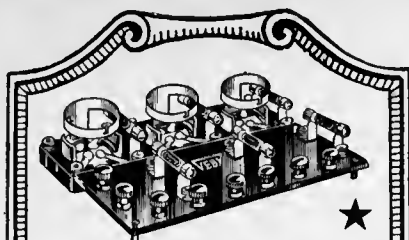

**The VEBY  
Resistance Coupled  
Amplifier**

A REVELATION to Music Lovers—amplifies all frequencies alike, thereby producing the radio concerts with utmost fidelity. Size 5x7 inches—fit within any receiving set. Price **\$12.00**

- A. F. 20 High Mu Tubes for R. C. Amplifiers. . . . . **\$3.00**
- A. F. 6 Power for the last stag e . . . **4.50**
- A. F. 30 Super High-Mu Tube. . . . . **6.50**

VEBY PRODUCTS are uniform at all times—you can depend on them. Manufacturers, Distributors and Dealers write or wire for particulars.

**VEBY RADIO COMPANY**  
"Quality Resistors"  
47-51 Morris Avenue  
NEWARK N. J.

**I**F you like this magazine with its coated paper and enlarged size—then why not subscribe and get it regularly — by the year, \$4.00, Six months, \$2.00.

Doubleday, Page & Co.  
Garden City New York



"a new 5-Tube Set with all the power and none of the grief of the Supers"—so wrote Henry M. Neely, Editor of Radio in the Home, Philadelphia.

**Get This Book**

Write to-day for this big fascinating 32-page booklet which tells how you can build the truly amazing new QUADRA-FORMER receiver. Based on a new radio principle, five tubes give remarkable results.

Enclose 10c and you'll have it by return mail

**Gearhart-Schlueter Radio Corp'n.**  
713 Voorman Avenue, Fresno, California



**-it's in the Tube**

A receiving set is no better than its tubes.

With other parts and connections *right* a set may be as good as its tubes—no set can be better.

That's why you want CECO Tubes. They stand up and deliver. With them your set works at its maximum. Clarity of tone, rich volume, long life—CECO has them all to a superlative degree.

Our charted tests (results confirmed by laboratories of national reputation) PROVE CECO TUBE SUPERIORITY—whether used as detectors, audio or radio frequency amplifiers.

CECO Tubes make a Good Receiver BETTER. Try them and you'll BUY them always—for results.

*Now Ready!* CECO Tubes with new type Long PRONG BASES. Also, Power Amplifier Tubes, E (Dry Cell Type), F (Storage Battery), for last stage of Audio Frequency.

Dealers write giving jobbers name.

**C. E. Mfg. Co., Inc.**

702 Eddy Street, Providence, R. I.

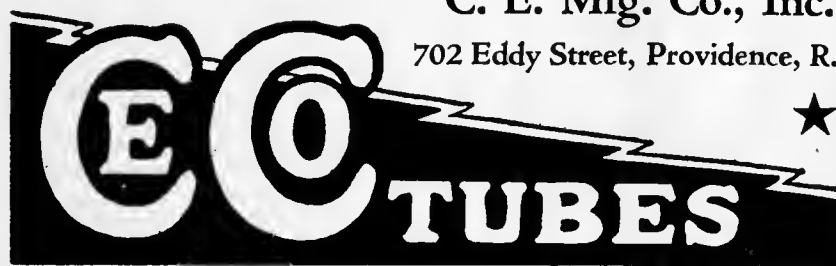

This is a good time to subscribe for

**RADIO BROADCAST**

Through your dealer or direct by the year, only \$4.00

DOUBLEDAY, PAGE & CO.

GARDEN CITY, NEW YORK



TRADE MARK REG.

Above types in copper—tinned copper—enameled copper—tinned bronze.

Loop wires in silk or cotton covered.

Litz wires.

Enameled wires.

**RADIO WIRES**

We manufacture all types.

Round braided antenna wires

Flat braided antenna wires

Round stranded antenna wires

Antenna supporting springs.

Cotton and silk covered wires for set wiring.

Write us for descriptive catalogue.

**ROSS WIRE COMPANY**

69 Bath St., Providence, R. I.

# ELECTRAD

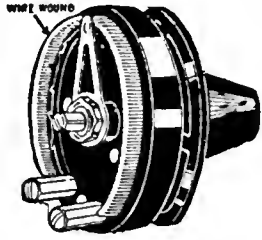

## Royalty Variable High Resistances

They provide all the flexibility of the throttle of a twin-six—better control of volume—complete control of tone quality and smooth variation of resistances.

Specially designed as a compensator or a volume control in audio amplifiers wherever a high resistance is specified. Neatly wire wound, indestructible, and the same setting provides the same resistance at all times. Bakelite moulded and provided with holes of standard spacing for panel or base board mounting.

Type A—Variable Grid Leak,  $\frac{1}{10}$  to 7 megohms.

Type B—1,500 to 100,000 ohms.

Type C—500 to 50,000 ohms.

Price \$1.50

Type D—Specially designed for control of detector plate current in B-Battery Eliminators. 10,000 to 700,000 ohms. Price \$2.00.

# ELECTRAD

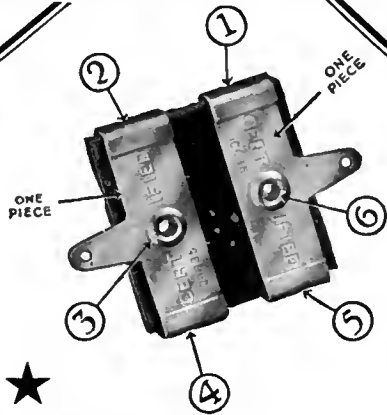

## The Six Point Pressure Condenser

The "Electrad" Certified Fixed Mica Condenser is a revelation in accuracy and design. Ingenious rigid binding and firm riveting fastens parts securely at Six different points insuring positive electrical contact. Value guaranteed to remain within 10% of calibration. Standard capacities, 3 types. Price 30c to 75c in sealed dust and moisture proof packages.

**ELECTRAD, Inc.**

428 Broadway

New York City

## Is All Broadcasting Advertising?

Whether advertising should or should not be permitted is a question which the radio public will ultimately have to decide for itself. It is a much-mooted question and one in which most of the readers of RADIO BROADCAST have a deep interest. As long as broadcasting stations are owned and operated by private individuals they will be advertising, regardless of whether they are or are not doing so in the abstract. When an announcer states that "This is station WPY, broadcasting from Bambell Brothers Store, West Oskaloosa," he is placing the name of that concern before the public in a manner which defies competition. Yes, after that, it is advertising, regardless of whether or not he broadcasts grand opera or education or economics. The letter printed below sets forth some very interesting ideas on the subject.

Editor, RADIO BROADCAST  
Doubleday, Page & Company,  
Garden City, New York.

SIR:

Referring to the invitation to express views on the matter of advertising matter being broadcast, I venture to ask if all broadcasting is not advertising? What difference does it make to the listener whether he is told that Miss Jones will sing from station WOC, the Palmer School of Chiropractic, etc., or that the A & P Gypsies will play from station WEA? In either case it will be a good number, well worth hearing. The number from WOC advertises the Palmer School, the one from WEA advertises the little red store. Or take for illustration the stations operated by educational institutions; is the purpose for which they are conducted to furnish laboratory facilities for their students or to make the college better known, that is, to advertise the college?

Speaking only from recollection, I am of the opinion that the newspapers were among the first to install broadcasting stations. In any event several good stations are still operated by newspapers. What purpose is there for the operation of stations by newspapers except advertising?

It seems to me that advertising is the logical support of a broadcasting station the same as it is the support of periodicals, and that there can be no more objection to advertising in connection with broadcasting than there is in connection with publishing. Any owner of a receiving set, except possibly a crystal set, is within range of more than one station and as free to make his choice of the station to which he listens as he is to read the newspaper he prefers. Any newspaper that cannot make its news pages of sufficient interest to have enough readers to make its advertising space valuable loses money and in time goes out of business. If a broadcasting station does not make its programs interesting it will have few regular listeners, it will have no advertising value and in time it will go out of business. If we could have a frank expression from the owners of the broadcasting stations that have been discontinued we would find that these stations were discontinued because they did not pay, in other words that they did not have sufficient advertising value to warrant the cost of operation.

The use of broadcasting for advertising purposes seems to be the logical way to maintain good broadcasting; the broadcasting has to be good to make the advertising worth while. Even the talks which are purely advertising, such as those given some time ago regarding tea and surety bonds, are in no way objectionable because such talks must be of sufficient interest to hold the attention of listeners, or they would dial another number.

Very Truly Yours  
B. O., New York.

# Building Better Service into RADIO PARTS



Aside from recognized radio uses in which no other metals can be substituted, COPPER and its alloys help you to make good radio sets *better* sets.

For instance, binding posts are superior posts, and battery nuts give best service and satisfaction when made of dependable free-cutting BRASS rod. And—their speedier production makes labor costs lower.

★ **COPPER & BRASS**  
RESEARCH ASSOCIATION  
25 Broadway, New York

RADIO FANS, a one-year's subscription to Radio Broadcast will cost you four dollars, two years six dollars. Consider this expenditure as being a necessary investment on your part for the future development of your own knowledge of Radio.

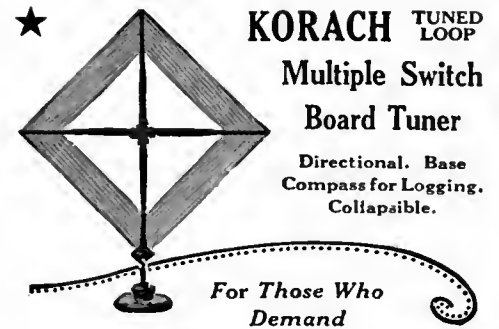

## KORACH TUNED LOOP Multiple Switch Board Tuner

Directional. Base Compass for Logging. Collapsible.

For Those Who Demand

### Superior Results

Leads the march toward perfect radio reception under all conditions. Not merely a "loop" but an ingenious arrangement of mechanical skill designed for superior results. L. M. Cockaday, using this loop, reached out across the Atlantic to hear many trans-continental Stations.

### Selectivity Plus Distance

Unheard of with common loop aerials. The Korach excels on all sets designed for loop reception. Priced at \$16.50 and for sale by all good dealers. Full particulars sent for 2c stamp and name of local dealer.

**KORACH RADIO CO.**  
20 E. Jackson Blvd. Dept. 8 Chicago, Ill.

Dealers and Jobbers:

Write to-day for attractive proposition.

## The KORACH JUNIOR

A modification of the "Senior" but possessing all its important features—\$12.50.





(Not a Wave Trap!)

It *IS* true!

188 times the energy... and there is absolutely nothing else at all like

# P E N E T R O L A

Without Penetrola the signal intensity of WOAI was 11, on the Audibility Meter—an impartial precision measuring device. With Penetrola the signal intensity of WOAI jumped above 2000—188 times the signal strength!

Without Penetrola the scientifically measured signal intensity of WCAL was 35, scrambled with WCBD at 29. With Penetrola WCAL went to 2000+ and WCBD to zero—*selectivity with a vengeance!*

This is just exactly the sort of thing any Penetrola demonstration will show you on any set with any number or arrangement of stages. The wanted station is immensely intensified; interference is overwhelmed by Penetrola. There is so much volume available for the most distant signals that a shorter aerial may be used, curing excess static. Your set is stopped from radiating, and is stabilized. It is needless to operate near the oscillation point. And dial readings stay substantially the same.

Radio principles known to be of immense promise, but hitherto elusive, are now successfully applied by Walbert Penetrola. The widely heralded Isofarad Circuit, latest development of Walbert engineers, is the foundation of Penetrola performance. Here is one radio appliance literally unduplicated in any way by anybody, because there is no other Isofarad circuit. Nor is there any substitute for Penetrola action, which amplifies *ahead* of the detector entirely, strengthening signals which would otherwise never be detected! Remember, signals too weak to detect cannot be amplified by any means placed *beyond* the detector.

In a few moments any receiver, however costly, can be transformed with Penetrola. Or anyone can quickly assemble the Penetrola kit and obtain amazing Penetrola results most economically. The Penetrola price buys performance which cannot be obtained with any amount of investment in a receiver alone.

**1st**  
Walbert  
Made It  
FIRST

For the sensation of the European tests note Penetrola Reception!

Penetrola in beautiful Black Crystallite, for Instant Attachment . . . . . \$35  
Penetrola Kit with Complete, Simple Instructions . . . . . \$15



If your dealer is not stocked, remit purchase price direct to factory and you will be promptly supplied. State whether you wish Penetrola for outdoor aerial or for loop receiver.

# W A L B E R T

Manufacturing Company, 923 Wrightwood Avenue, Chicago

# RADIO BROADCAST

ARTHUR H. LYNCH, Editor  
 WILLIS K. WING, Associate Editor  
 JOHN B. BRENNAN, Technical Editor

FEBRUARY, 1926  
 Vol. VIII, No. 4

## CONTENTS

Cover Design . . . . .	<i>From a Painting by Fred J. Edgars</i>	
The Hamilton Rice Expedition . . . . .	<i>Frontispiece</i>	426
Radio: The Jungleman's Newspaper		
	<i>John W. Swanson</i>	427
The March of Radio . . . . .	<i>J. H. Morecroft</i>	431
Design of Radio Inductances . . . . .	<i>W. W. Harper</i>	436
How to Build a Grimes Inverse Duplex		
	<i>Florian J. Fox</i>	439
Prize Contest Announcement . . . . .		444
The Listener's Point of View . . . . .	<i>John Wallace</i>	445
"Radio Broadcast's" Universal Receiver . . . . .		450
"How Long Will My B Batteries Last?"		
	<i>George C. Furness</i>	452
How to Use Vacuum Tubes . . . . .	<i>Keith Henney</i>	456
The 1926 International Radio Broadcasting Tests		
	<i>Willis K. Wing</i>	462
"Radio Broadcast's" Booklet of Foreign Broadcasting Stations . . . . .	<i>Lawrence W. Corbett</i>	465
As the Broadcaster Sees It . . . . .	<i>Carl Dreher</i>	467
Wavelength-Frequency Conversion	<i>Homer S. Davis</i>	471
Wavelength-Frequency Chart . . . . .		472
The Grid—Questions and Answers . . . . .		482
An Explanation of Tuning How to Obtain Better Regeneration Protecting the Loud Speaker C Batteries in the Detector Circuit		
"Now, I Have Found" . . . . .		488
Quarterly Prize Award Announcement Using a Voltmeter as a Milliammeter Coil Design Data A Simple Long-Wave Receiver A Good Audio Amplifier Improving the Volume of the Two-Tube Roberts Winding Spider Web Coils		
What Constitutes a Radio Patent? . . . . .	<i>Leo T. Parker</i>	494
A Key to Recent Radio Articles	<i>E. G. Shalkhauser</i>	504
Book Review . . . . .		514
"ECONOMICS OF THE RADIO INDUSTRY"		
What Our Readers Write . . . . .		518

## BEHIND EDITORIAL SCENES

PROBABLY one of the most interesting numbers of RADIO BROADCAST presented to our readers in a long time is this February magazine. To start it off, Mr. John W. Swanson, who is now a radio inspector for the Department of Commerce, with headquarters at Norfolk, Virginia, tells of the unusual experiences he and his comrades had on their trip to the headwaters of the Amazon and shows how short waves saved the day. Mr. W. W. Harper, who wrote "Design of Radio Inductances" on page 436, is a consulting radio engineer in Chicago who has practically lived with coils in his laboratory for the past year. His conclusions should excite considerable comment and, in addition, prove very valuable to every home constructor. Florian J. Fox, who prepared the very complete constructional article on the four-tube model of the Grimes Inverse Duplex Receiver, is chief engineer of the Grimes Radio Engineering Company. The reader will notice that on page 441 appears a complete chart of the set being described. The same terse description was applied to the short wave transmitter in the January magazine. It would interest us to know whether readers like this feature well enough for us to continue it. Write us and let us know.

THE \$500 prize contest for the design of a non-radiating short-wave receiver indicates one of the most unusual steps taken in the short-wave communication field. Amateur experimenters have already shown that they will try hard to meet the challenge to their ability. The four receivers shown on pages 450 and 451 follow those models of the "Radio Broadcast Universal Receiver," so completely described in this magazine for January. The Universal has jumped into more than immediate popularity, not merely because RADIO BROADCAST and others say it is good—that, by the way is certain, for it was developed in our own laboratories—but chiefly because others have found it to be good. Mr. Henney's article on how to use vacuum tubes on page 456, lives up, we are certain, to all the promises made for it in this space last month. The transmitting schedule for all stations in the International Tests during the week of January 24th will be found on page 463, together with all late information on the Tests in the article which accompanies it.

ERRORS, when they occur, should be corrected and not glossed over. In Roland F. Beers's article, "An Improved Plate Current Supply Unit" in our December number, it was stated on page 190 that "one lug of the single-pole double-throw switch goes to the full secondary terminal at 1250 turns." The phrase should read "primary" for "secondary." The proper placement of the tap and its circuit connections are evident from the wiring layout and circuit diagram accompanying the article.

NEXT month we expect to print details of the design of a very interesting receiver, from the pen of a well known radio man, whose talents entitle him to be mentioned in the same breath as Dr. Walter Roberts. The third of the "Home Radio Laboratory" articles, prepared by Keith Henney, will appear in March also. This should please many constructors who have reached the "end of their string" and who have shown such great interest in the possibilities opened up by these articles. Mr. J. C. Jensen, who has spent much time in research on the subject, will have a fascinating and stimulating article on how radio reception can be calculated from known weather conditions. It is worth waiting for.—W. K. W.

### Doubleday, Page & Co. MAGAZINES

COUNTRY LIFE  
 WORLD'S WORK  
 GARDEN & HOME BUILDER  
 RADIO BROADCAST  
 SHORT STORIES  
 EDUCATIONAL REVIEW  
 LE PETIT JOURNAL  
 EL ECO  
 THE FRONTIER  
 WEST

### Doubleday, Page & Co. BOOK SHOPS

NEW YORK: { LORD & TAYLOR BOOK SHOP  
 PENNSYLVANIA TERMINAL (2 Shops)  
 38 WALL ST. AND 166 WEST 32ND ST.  
 GRAND CENTRAL TERMINAL  
 ST. LOUIS: { 223 NORTH 8TH STREET  
 4914 MARYLAND AVENUE  
 KANSAS CITY: { 920 GRAND AVENUE  
 306 WEST 47TH STREET  
 TOLEDO: LASALLE & KOCH  
 CLEVELAND: HIGBEE CO.  
 SPRINGFIELD, MASS.: MEEKINS, PACKARD & WHEAT

### Doubleday, Page & Co. OFFICES

GARDEN CITY, N. Y.  
 NEW YORK: 120 WEST 32ND STREET  
 BOSTON: PARK SQUARE BUILDING  
 CHICAGO: PEOPLES GAS BUILDING  
 SANTA BARBARA, CAL.  
 LONDON: WM. HEINEMANN LTD.  
 TORONTO: OXFORD UNIVERSITY PRESS

### Doubleday, Page & Co. OFFICERS

F. N. DOUBLEDAY, *President*  
 A. W. PAGE, *Vice-President*  
 NELSON DOUBLEDAY, *Vice-President*  
 RUSSELL DOUBLEDAY, *Secretary*  
 S. A. EVERITT, *Treasurer*  
 JOHN J. HESSIAN, *Asst. Treasurer*

DOUBLEDAY, PAGE & COMPANY, Garden City, New York

# AMERTRAN

TRADE MARK REG. U.S. PAT. OFF.

## DE LUXE

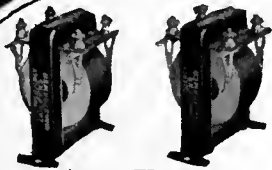
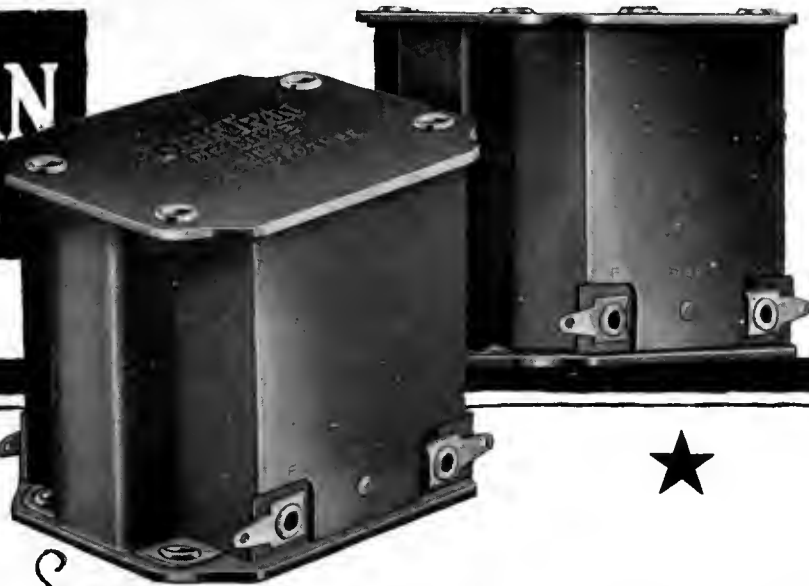

AMERTRAN  
Types AF-7 and AF-6

AmerTran audio transformers Types AF-7 and AF-6 have been considered for years among the leaders in audio amplification. These popular and efficient models may now be purchased at a considerable saving in cost. Types AF-7 (ratio 3½:1)—AF-6 (ratio 5:1) . . . \$5.00 each



The  
AMERTRAN Power Transformer

Type PF-45, 65 Va-60 cycles 110 volts  
primary, 450—8/4-8/4 secondary

Type PF-45 is intended for use on the standard 110 volt, 60 cycle house lighting circuit. It has three separate well-insulated secondary windings. These are enclosed in a strong metal case provided with mounting feet. The secondary leads are standard code flexible wires left long enough to reach the terminals in the average set without splicing. This transformer is well suited for supplying AC power for filter circuits, and is designed with the usual margin of safety . . . . . \$15.00 each

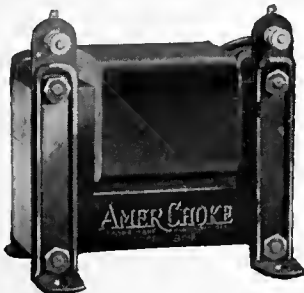

The New AMERCHOKE  
Type 854

Type 854 is a scientifically designed impedance or choke coil of general utility, designed primarily for use in filter circuits. As an output impedance for by-passing direct current from the loudspeaker it is just as efficient and more economical than an output transformer. When used with a 1 mfd. (or greater) fixed condenser, the tone quality equals that of the best output transformer. DC saturation is prevented by two adjustable butt joints in the core. \$6.00 each



## A New Standard of Excellence in Audio Amplification

THIS new audio transformer has been developed for those who are satisfied only with the utmost in quality. It possesses an unusually straight line frequency characteristic extending the range below the lowest note now being broadcast, and actually shows a gain of about three octaves below that previously obtained.

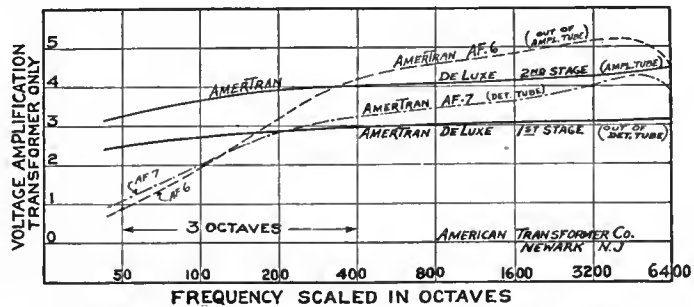

The AmerTran De Luxe is a transformer of moderate size and weight, enclosed in a strong metal case with mounting holes at both top and bottom so that it may be inverted, affording simplified connections. While the AmerTran De Luxe will improve any set, appreciation of its uniform amplifying qualities can best be realized when operated in conjunction with straight line frequency loudspeakers, such as the best cone and disc types, and with a tube in the last stage capable of handling the output.

The AmerTran De Luxe is made in two types, one for the first stage and one for the second stage, and plainly marked as such. The chief difference between these two types is that the first stage transformer has approximately 50% greater primary inductance than the second stage transformer, thus more nearly corresponding to the operating impedances of the tubes out of which they work. For this reason it is advisable to purchase and operate these transformers by the pair!

PRICE, EITHER TYPE, \$10.00

Write for descriptive booklet on AMERTRAN Radio Products

### American Transformer Company

178 Emmet Street, Newark, N. J.

"Transformer builders for over twenty-four years"

SOLD ONLY AT

# AUTHORIZED AMERTRAN DEALERS



#### RADIO AND THE HAMILTON RICE EXPEDITION TO BRAZIL

The country conquered by men, flying machines, and radio. The large photograph, taken in the expedition's advance airplane piloted by Walter Hinton, was made by Captain Albert W. Stevens of the United States Army Air Service whose photographs are world renowned. The expedition proceeded up the Rio Negro 500 miles from Manaus, Brazil. Manaus is 1500 miles from the ocean, and the base of the explorers was set up at Boa Vista. The Rio Negro at the point photographed is about three and a half miles wide and appears a veritable archipelago of curious shaped islands. The photograph above shows the short wave transmitter and receiver used to maintain communication with the outside world. The natives, after they gained courage enough to wear the phones, showed little surprise at the "white man's magic" when they heard the short wave broadcast signals from KDKA and WGY through the head set

# RADIO BROADCAST

VOLUME VIII



NUMBER 4

FEBRUARY, 1926

## Radio: The Jungleman's Newspaper

How the Rice Expedition in the Jungle Maintained Communication with the Outside World  
—A Triumph of Short Waves and Low Power When Long Waves and Higher Power Failed

By JOHN W. SWANSON

*Chief Radio Operator of the Expedition*

NOT so many months ago the public was thrilled to read in its morning newspapers an account relating how radio amateurs all over this and other countries had established two-way communication with the Rice exploration party, then in South America. Receiving apparatus only had been carried on the two previous expeditions, which was used for reception of time signals, necessary in accurate topographical surveying, and of press dispatches, which were, to the members of the expeditions, what the London *Times* is to King George's subjects. Radio's capable handling of these assignments led Dr. A. Hamilton Rice, vice-president of the American Geographical Society, when his third expedition was being organized at New York, to allot a more important task to the writer, who had been radio operator on the preceding Brazilian ventures.

Where radio had been acting the part of a listener, a masculine part, if you please, it was to be given a tongue on the third expedition and, now cast in a feminine rôle, was, if its abilities were not overestimated, to keep the advance exploration party in touch with the base party, and the base party, through stations of the Brazilian government, on speaking terms with the rest of the world. It must be admitted that this mission assigned by Doctor Rice was regarded with a certain amount of doubt and misgivings on the part of the radio personnel. The advance party, in the

first place, could only carry featherweight apparatus and an insufficient source of power supply, while the erection of efficient antennas would present a big problem. The interior of South America, experience had taught, bred static as it did fever, while venomous insects and rank vegetation were not the least of their troubles.

How far radio's performance exceeded expectations; how "it might" became "it did," is a tale which deserves a paragraph or two in the history of short-wave communication. Called on to bridge one hundred—two hundred miles of jungle, the Rice Expedition's transmitters night after night, months on end, laughed at the 3000-odd miles of space between upper Brazil and the United States. Naked, half-savage Indians were the explorers' neighbors while the operators whispered into the ears of amateur radio men over half the civilized world.

To the American amateur is due a large share of the credit of the success of the Rice Expedition's employment of radio in the Amazon valley. Playing for love of the game alone, they handled the cards as if the stakes were gold and mountain high. Hats off to 2 AG, 2 BR, and 2 CVS, of New York City, 1 COT of Braintree, Massachusetts, 3 ATE—Baltimore, 8 ES—Akron, 5 SK—Fort Worth, and the others! Radio is a game at which one cannot play a lone hand and Thomas S. McCaleb, former inspector for the Independent Wireless Telegraph Company, of New York, was the writer's capable assistant and fellow burden bearer in the tropics.

The expedition's radio history begins at New York City where, previous to taking ship for Para, at the mouth of the Amazon, \$6000 was expended upon a stock of radio material which ran up and down the list from binding posts to generators, fifty-watt tubes to bus bar. Variable condensers are conspicuous by their absence on the store shelves of small Brazilian towns, and no explorer has yet discovered a jungle palm tree which bears milli-volt meters. Once in the jungle there was continual construction and destruction of transmitters and, to some extent, of receivers.

AMERICAN BROADCASTING  
HEARD



LISTENING TO KDKA

From the midst of the jungle. WGY was another short-wave station heard. When the short-wave apparatus was first tried out at Manaus, only three stations were heard. Two of these, curiously enough, were broadcasters, while only a single code station was heard

INITIAL tests of the radio apparatus were made at Manaus, an Amazon town of 5000 inhabitants, 900 miles from the ocean, and the jumping-off place for

these who probe the uncharted interior of the great southern continent. Here the expedition's 400-watt transmitter was set up temporarily and put in operation on 200 kc. (1500 meters). With this set the Para station, 850 miles distant, was "raised" without difficulty.

Tests of short-wave receiving equipment at Manaus did little to bolster the confidence of the radio detachment. Nights of dial-twisting and ear-straining brought in but three short-wave stations, two of them broadcasters. Hearing KDKA and WGY with regularity on high frequency was, it is true, a distinct contribution to the expedition's entertainment, but reception of a lone code station—it was 8 X1—was discouraging. The road ahead appeared as dark to the radio men at this stage as the native tobacco they were smoking.

Radio work at Manaus was drawing to a close when a political tidal wave engulfed the town. Making merry in the Hotel Grande on July 23, at a gathering to welcome others of the party who had just come up the river to join their fellows, the radio men were thrust into box seats at a South American revolution.

Zero hour came without warning. From the restaurant windows the explorers were gazing idly, between drinks, at a detachment of olive-skinned soldiers shuffling down the Broadway of Manaus. Troops in movement are so frequently encountered in South America that the military exhibition awakened no interest until the infantrymen halted, took interval quickly, and sent a steel-jacketed shower in the direction of the governor's palace. A bullet in motion is not a desirable neighbor, no matter who fires it. There is small comfort in the knowledge that marksmanship is bad when brick dust begins to fly. There was a great slamming and barring of doors and windows within the Hotel Grande restaurant, and a scramble for safe places behind thick walls as the government of Manaus began to totter.

Soon a panting revolutionary wormed the news though a crack in the hotel door that *right* had triumphed. "Long live the revolution," in its equivalent Portuguese, came between gasps.

Screwing up courage after a time, the Americans filed out upon Rua 28 do Setembro to find all quiet. They stole softly down dark thoroughfares where the arc lights had gone on the casualty list. Carefully they trod to avoid slipping on the blood which, they judged from the wholesale expenditure of powder, must have showered the rough pavements. Their guess was wrong; no blood or dead. Even the martyred donkey, the usual accompaniment to tropical internecine strife, was not encountered. Thousands of brass cartridge shells underfoot and the white flag flying above the governor's palace alone lay in the wave of the revolution. Next morning, commercial Manaus was doing business at the same old stand.

Rebel rule imposed strict surveillance upon foreigners, but the upheaval little

hampered the expedition's work, though it brought an end to radio tests. The interdiction of ether communication at Manaus by the de facto government was followed by a laughable incident, the humor of which registered even upon the officials who called the Americans to account when it was reported to them that antennas had been erected by the explorers on the outskirts of the town.

Without much difficulty, official Manaus was convinced that what had been described as "radio wires" were baited fish lines set to catch turkey buzzards, the blood of which was being analyzed by the medical branch of the party. When the time came to move upriver, an old stern wheel steamer transported the party to Vista Alegre, on the Rio Branco, where the first semi-permanent camp was established. Ascertaining that Vista Alegre was a poor radio location, the two operators put their equipment aboard a batalao (a barge towed by a steam launch), and proceeded further upstream to Boa Vista, which was to be the expedition's base during the time the advance party was in virgin territory.

During the batalao's slow ascent of the river, the radio men slept in filthy quarters, foggy with mosquitoes. McCaleb went down with high fever the day of his arrival at Boa Vista. Two weeks he lay ill at the small mission, attended by the kindly padres, a casualty of the never-ending conflict between man and the insect life of the Brazilian river country.

The anthem of the Amazon valley is the whining, petulant song of the mosquito, chief of a happiness-blighting clan which includes the pium, a smallish black fly with a red-hot snout and others whose names would carry nothing to American readers but whose blood-sucking operations would shame even a radio gyp dealer.

Against these barely visible foes the expedition fought. They were its unwelcome guests at meals, its bedfellows; many a radio message sent by LR, the portable station set up at camps and bivouacs beyond civilization's frontier, was dispatched by operators whose right hand tapped the key and whose left repulsed an insect onslaught.

Larger insect enemies included several species of the ubiquitous ant, whose acquaintance was made at Manaus, and hornets encountered in the jungle. They attacked apparatus as well as operators.

Anti-ant measures became a regular part of radio routine after the short-wave receiver, opened one day for inspection, was found to be full of very live radio bugs. A blow torch, in McCaleb's hands, did for the most of them. Those escaping cremation perished under the huge feet of Chico, native servant of the radio detachment.

Hornets, of a species which build a mud dwelling, took possession of LR one day upriver. The operator found that all crevices in the apparatus had become hornet home-sites. Their mud huts shorted the grid and plate terminals of one transmitter tube and a veritable firework display resulted when the current was turned on.

#### ESTABLISHING THE BASE STATION

WHILE McCaleb convalesced, the erection of a station at Boa Vista went forward, the main trouble encountered in putting it up being inability to secure timber for masts in a treeless country. Four days' journey from the camp mast material was found, cut and floated. With the help of natives, most of them Indians, three masts went up, eighty, seventy-five, and forty feet high. An antenna for long-wave work was suspended between the two highest; a short-wave antenna was hoisted between the shorter sticks. There was an elaborate ground system for long-wave work and a litzendraht cable counterpoise for the high-frequency set.

There followed six days of calling and listening while static alone caused the head-phone diaphragms to vibrate. Two operators were deep in the dumps, half-sick and nearly played out when a woman's voice floated in on the sixty-meter wave. The song, ironically enough, was "Happy Days." KDKA's short-wave set did a physician's work at Boa Vista that night.

An American amateur, 4 SA, shattered the silence with a readable signal the next night, but failed to respond when called repeatedly. This was a disheartening chapter and the events of the next few days produced more gloom.

McCaleb, sent down the river to join the expedition proper at Vista Alegre, took with him the twenty-five-watt transmitter, hoping to effect communication with the base station wjs at Boa Vista, as the expedition moved along. The attempt failed dismally.

The only silver lining during these days of discouragement was that another American amateur was heard, and wsc, an American coastal station of the Radio Corporation, boomed in. They could not be made to hear us, however. Then things brightened for Manaus, called in vain for days, one morning responded with a snappy "O. K." This was a slice of bacon where a whole side of meat was needed.

The base party having established itself at Boa Vista, and McCaleb in charge of wjs, the advance party early in December set out on the jungle trail, the twenty-five-watt transmitter, under the wing of the writer, accompanying it. Communication between the two parties was established without difficulty after the advance party had made some progress, and radio stock soared. Equipment overlooked when the advance party set out, and needed urgently by the scientists, was ordered dispatched in pursuit from Boa Vista. The portable set was demonstrating its usefulness.

At this juncture, with things going swimmingly, partial failure suddenly loomed in the radio detachment's path. Short waves and the American amateur saved the day.

The rock on which the radio plans threatened to wreck was the heavy tube mortality at wjs. The fifty-watters expired in such numbers that not enough remained to



ERECTING WJS'S MASTS

The wood for which had to be brought from a point four day's journey away as no suitable trees were found at Boa Vista

power the long-wave base transmitter. The Boa Vista-Manaos link broke and the expedition's communication with the outside world was disrupted.

Now McCaleb's short-wave experiments bore fruit. During the months since the expedition's sailing, the great amateur migration to the 40-80 meter band had taken place. So, unable to work Manaos which was, as radio distance is measured, but a step away, wjs began shooting Rice Expedition traffic almost daily to American amateurs. First two-way communications was effected with 2 cvs, New York City. This success was followed by the transmission of long and important messages to dozens of other amateurs in the United States, two in England, one at Buenos Aires, and to sj, the United Fruit Company's efficient station at San Jose, Costa Rica.

JUNGLE RADIO ADVENTURE

SOME of the traffic was destined to American points but much of it was addressed to Manaos. Consider what this meant: Manaos was 400 miles from wjs but could not be reached direct during the tube shortage days. A message for Manaos went 3000 miles by ether to the United States, 3000 miles by cable from the United States to Para, then by radio, a matter of nearly 1000 miles, to Manaos. Costly? No end. Subject to delays? Yes, frequently. But the messages, many of them of utmost importance to the party, reached those to whom they were addressed, and that was the object of the game.

The advance party, with its portable set, had now penetrated well into the dense forests it had come to explore and map, its canoe fleet daily engaging the rapids of the turbulent stream, which the Indians who live beside it have appropriately named "The Poison River."

In a clumsy, heavy, spoon-billed craft, more scow than canoe, radio made its fight against the angry river, its guardians being Weld Arnold, jovial topographer of the expedition; an Indian boatman of the region; Antonio, in whose veins ran mixed negro and Indian blood; and the writer.

There were many rapids up which the canoes could be pulled by ropes, but some, more waterfalls than rapids, would stop a salmon's upstream rush. Encountering these, the canoe fleet was forced to portage. This meant heart-breaking labor under an unrelenting sun. It meant more than carrying equipment and canoes on the backs of men to navigable water above the obstruction, because, in order that this could be done, a trail must first be hacked with machetes through the jungle, which came down to the river banks. On a day when the river seemed set to baffle the canoeists, the party gained, with infinite labor, an advance of one-half mile. Camp was made that night within sight of the camp of the night before.

Beau Brummels of the advance party fought the river in B. V. D's and bathing suits.

From day to day the program varied little: During daylight a contest with the river; in late afternoon selection and clearing of a camp site, pitching of fly tents and preparation of the evening meal, which, if the hunters had made a kill, might include a venison steak sweet and juicy enough to tempt an epicure; at night, work by the map-makers, the scientists and the radio man, each with his specialty.

Erection of an antenna was the first step in establishment of radio stations at



LR'S POWER SUPPLY

Which consisted of a dynamotor operated by storage batteries. The batteries, in turn, were charged by an auto generator belted to an outboard motor which in turn did canoe duty at other times. The plates of the two fifty-watt tubes received 500 volts

the jungle camps. Trees were the masts, and the vegetation for some distance about the antenna trees was cleared away to give the wires breathing space. Obtaining an efficient ground was no problem; a length of antenna wire thrown into the river served well. The receiving antenna was usually a thirty-foot length of wire, suspended one foot off the ground. The low antenna reduced signal strength materially but reduction in static more than compensated for this loss. In a tropical region, where every night is a static night, LR thumbed its nose to atmospherics.

The portable station's short-wave receiver, put together in the wilds out of camp odds-and-ends, including two empty sugar tins procured from Kwong, the Chinese cook, was a thing to bring a blush of shame to the cheek of the radio constructor who likes to see things shipshape. That its appearance was not a measure of its sensi-

tiveness was demonstrated when it picked up amateur signals from every radio district of the United States, and from several foreign countries. A simple Armstrong circuit was used.

The transmitter, designed for 100-meter work, was revamped upriver after its operator became convinced that better results were obtainable lower down the scale. Alterations fitted this set for eighty and forty meter work. The lack of a wavemeter at the portable station was met one night when the operator had the good fortune to pick up the standard frequency



A CABOCLOS VILLAGE IN THE MIDST OF THE JUNGLE

They are a Portuguese-Indian people, and, after being presented with a few cigarettes, proved most hospitable. The flying boat, which was piloted by Lieutenant Walter Hinton and used to survey the country ahead of the expedition, made a forced landing at this point. The walls of the thatched house were covered with pictures cut from various magazines, among which were some of the 1922 New York-Rio de Janeiro flight. The natives became wildly excited on being informed that Lieutenant Hinton was the pilot on that trip

signals emitted by wvw, the Bureau of Standard's station at Washington. Utilizing the system of harmonics, a hastily assembled, but accurate instrument, was calibrated.

The portable station's power supply was a dynamotor operated by storage batteries, which were charged by an auto generator belted to an outboard motor, which in turn did canoe duty at other times. The plates of the two fifty-watt tubes received 500 volts.

Both outboard motor and generator threatened frequently to give up the ghost but were nursed along to a remarkable performance by the gas engine experts of the party who lent a hand to the radio operator when failure of the power supply loomed.

Jungle days and nights were crammed with incidents. Among them there was an encounter with tucandera ants whose sting, which carries a long-lived pain, the natives dread more than that of any other insect.

The operator's carelessness in lashing one end of his hammock to a dead tree, which gave way in the night, made him food for the tucanderas. Extricating himself in the darkness from the fallen hammock he rolled into their nest. He remained there but a moment—there is a limit to man's endurance—but the tucanderas which had crawled into his clothes emerged from the ant hill with him. Before all were routed the radioman's skin, from head to foot, burned with the fire to which the wicked are headed.

More pleasant recollections are those of the visit to one of the river camps of four naked Guihibo Indians, shy but not unfriendly savages of the country traversed by the explorers. Their call on the white men, the natives of the party learned from them, had been made at some difficulty. It appeared that enemy country lay between their village and the explorers' camp, and the enemy had sought to block their route. It had been necessary for them to slay four hostile tribesmen. Arrows, as long as spears, were their main weapons; a dugout canoe their means of getting about.

There were few nights spent in camp when traffic was not exchanged between wjs and LR and scarcely a night when signals from American amateur stations were not heard on the crude short-wave receiver. Due to the necessity of conserving power, the portable station's messages destined to the outside world were habitually shot to the base station, which relayed them north-

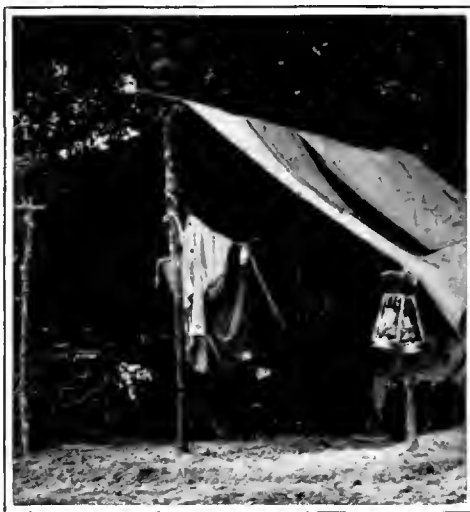
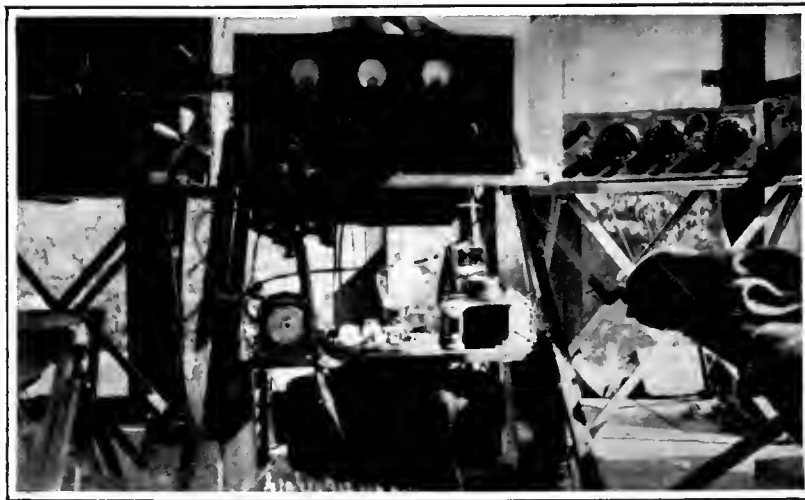

THE EXPEDITION'S RADIO APPARATUS

The upper picture is of the interior of the base station at Boa Vista. It was intended that wjs (the base station) should be employed for communication with the station at Manaos, a distance of about four hundred miles, but heavy tube mortality at Boa Vista brought long-wave medium power work with Manaos to an end. Short-wave communication was then established with amateur stations in the United States, using low power and smaller tubes, the supply of the latter being plentiful. Messages for Manaos reached their destination by a round-about route, often going to New York first. The advance party's short-wave station, LR, provided the connecting link with wjs. The second picture shows LR's "shack" at one of the camps. Below: Natives listening to code signals on the short-wave receiver

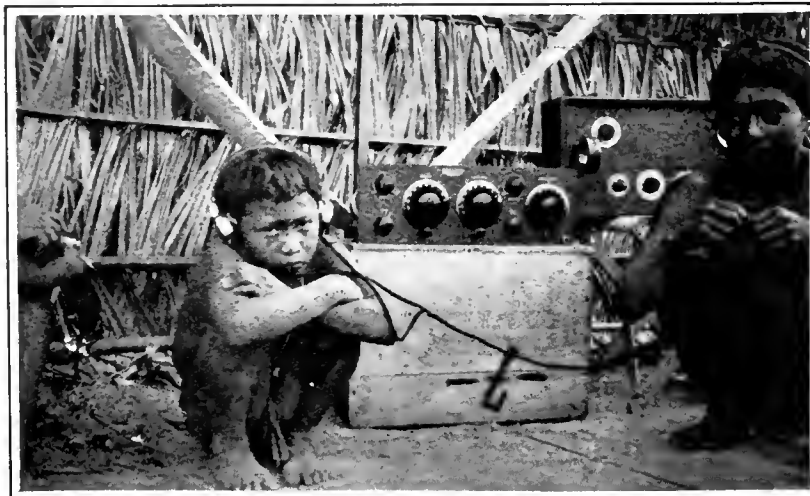

ward. This was, however, no insult to the twenty-five-watt set at LR for, on one occasion, when the operator's curiosity to learn how the low power equipment would reach out got the best of him, he passed with ease a message direct to station 4DO, of M. M. Burns, at Atlanta, Georgia.

Radio operations during the final months of the expedition's work in the tropics followed the lines established during the period with which this article deals. On February 23, 1925, the writer returned to Boa Vista by

means of an aeroplane used mainly in mapping from the air. His leave from the Department of Commerce expired, so he came back to the States. McCaleb took over the portable station and capably handled his task until early summer, when the explorers came home.

There were times when, unsuccessful in "raising" wjs on eighty meters, a shift to the forty-meter wave brought immediate results. Even after nights when signals carried poorly, when static was terrific, there was a short period just following sunrise when the world could be heard. Sometimes this fruitful interval lasted two hours; often not longer than fifteen minutes.

The amount of power used in transmission appeared not to be a factor of much importance. Many of the amateurs heard in the forest were using sets with as little as ten watts of power. McCaleb reported that he was often warned that LR was about to call, by a clearly audible sound which could only have been occasioned by a minute amount of radio frequency energy leaking into the antenna when the tubes were lighted but when the key contact points were not actually meeting.

Elevation above sea level was important, the ease with which traffic could be handled apparently varying almost directly with the elevation. During early evening the short waves gave poor results. It was a rare night when much work could be done before 9 o'clock.

On the whole, while transmission on high frequencies proved to a certain extent freaky, communication was established over such long distances, with so little power that the conclusion seems unescapable that short waves will come to be used extensively in long range work. We have not yet solved many of the mysteries of their propagation but we have opened the gate wide enough to enable us to see that there is much inside the field we hardly realized, until recently, was ours to explore and to use.



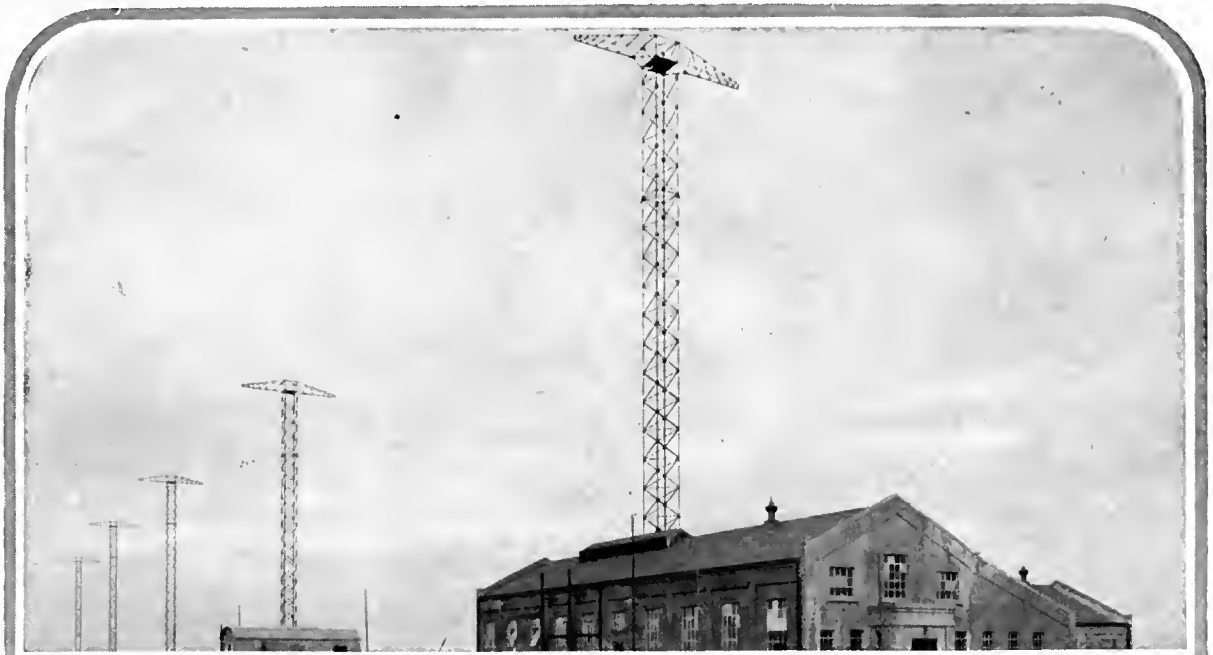

# THE MARCH OF RADIO

By *J. A. Morecroft*

Past President, Institute of Radio Engineers

## What Happened at the Fourth National Radio Conference

**T**HE radio industry is to be congratulated upon the outcome of the deliberations of the 1925 Radio Conference, and this seems to be the burden of the average editorial comment throughout the country. The spirit in which the various questions were approached and the remarkable display of reasonableness on the part of the many conferees augurs well for the healthy development of our industry.

The radio industry can well get along with no governmental interference or help—that was the keynote of Secretary's Hoover's opening address and that was the natural conclusion to be reached from the deliberations of the conference. Many people are too ready to ask the government to regulate something or other, somehow or other, so that it is remarkable that no action was taken along this line.

To legislate away the regenerative receiver, to subject the advertising question to federal legislation, to pass laws closing down the super-power stations, even before they had started; many such questions were in the air waiting to be settled by government action of some kind and yet the conference actually put through no such resolution.

The one action of the conference which

stands out more than any other was the stand taken on the number of broadcasting stations. The opinion of the conferees was almost unanimous in favor of positively limiting the number of licenses issued. We have advocated the limitation of the number of stations for a long time and certainly it is gratifying to hear the voice of the conference so unanimous in settling this question. The conference recommended that the number of stations is not to be increased, but is actually to be diminished. No new licenses are to be issued and those licenses which become forfeited because of disuse are not to be reissued to another station unless there is a demand from the public. The pleasing thing about this action is that the question was settled with the purpose of satisfying the radio listener instead of the station owner. The public is surely to be congratulated upon this stand taken by the conference. It all simply means that the radio listener's interests are to be paramount in guiding the future licensing of stations and matters of similar import.

"It is a piece of hard luck," remarks one commentator, "for the would-be station owner who has his station built and paid for, to be told that no license is available and his investment is valueless." How-

ever, unless the broadcast listeners in his neighborhood show unmistakably their desire for the new station it should remain silent. No one has a right to intrude into ether channels where he is not wanted and those who know whether he is wanted or not are the neighboring listeners.

Coöperation between various branches of the radio industry, no governmental regulation or censorship, settlement of interference troubles entirely in the interests of the broadcast listener—these three features stand out as real accomplishments of the Fourth National Radio Conference so well directed by Secretary Hoover.

### A Praiseworthy Bit of Radio Research

**I**N NOVEMBER, 1925, a most remarkable paper was presented to the Institute of Radio Engineers by a group of three researchers of the American Telephone and Telegraph Company, Messrs. Bown, Martin, and Potter. To those of us who look upon radio primarily as a branch of electrical engineering rather than simply a scheme of communication, the paper seemed to be the best which has been presented in years. Of all the divisions of engineering, electrical is the most accurate and scientific. Of the branches of elec-

The photograph above shows the towers of the beam station at Dorchester, England, which will communicate with New York.



RADIO ON MOVING TRAINS

Passenger trains of the Canadian National Railways making the transcontinental run are all equipped with broadcast receivers. The installation of a receiver to give regular service has been entirely successful. On one trip of the "Quebec," the following stations were logged by operator N. Bonneville, who is seen in the view here: WBZ, KDKA, WFI, WGBS, WOR, WEA, CKAC, WGR, WGN, WJAS, WCAE, CNRO, WTAM, WAAF, WGY, and WCX

trical engineering, that dealing with radio phenomena contains the most intricate and interesting problems. To the student who has a keen imagination, a reasonable grasp of mathematical relations, and an intense desire to penetrate into the unknown, there is today probably no more attractive field than that in which Bown, Martin, and Potter have been working for the past two years and about which they reported in their recent paper.

There are three general subdivisions in radio engineering which offer opportunities to the experimenter. The receiving set is being made the subject of intensive study by thousands of keen experimenters. The cost of suitable laboratory facilities is comparatively little and the reward for a worth while discovery is ample and sometimes fabulous. The transmitter can be made the subject of development work by comparatively few. Expensive apparatus is required and only a small group of engineers of the large companies can possibly work on the improvement of transmitters.

There is another field of radio investigation, however, which apparently offers no financial return for successful endeavor, that is the question as to how radio energy is actually carried from the transmitter to the receiver. Even a complete answer to this question may bring with it no material reward of any kind. One says "may" because there have been several cases in the past in which an apparently useless scientific research has yielded tremendous financial returns to those who developed the idea. We think of the work of Richardson and

other "pure scientists" who studied the evaporation of electricity from metal, working simply to discovering the truth, then we consider the profits of the Radio Corporation of America last year on tubes, which utilized the result which these scientific workers gave to the world for nothing.

The question of how radio waves are transmitted can be tackled only by the best trained engineers we have today. Not only must they be able experimenters, but to make any reasonable progress based on the interpretation of their results, they must be conversant with many allied branches of science. The electro-magnetic theory of light (the bugaboo of many a student of college science), must be thoroughly understood and the laws of reflection and refraction of such waves be sufficiently familiar that their occurrence is at once recognized.

In the experiments reported to the I. R. E., the engineers used many thousands of dollars worth of the most modern electrical apparatus; the experiments were such that only one or two of the most prosperous companies could afford to finance them. The American Telephone and Telegraph Company really felt the need to investigate the question because of the very poor quality of WEA's signals throughout Westchester County, only a short distance from the transmitter. Not only was the signal unexpectedly weak but the quality also was poor. So began a most exhaustive study to discover just what happened to WEA's radio waves as they traveled the fifty or more miles up Long Island Sound.

These experiments showed conclusively that the signal received in these defective localities is produced by waves arising from two directions. One wave comes along the ground and is greatly weakened as it travels through New York's forest of steel skyscrapers. The other goes apparently up in the air and is reflected after going up perhaps one hundred miles and comes down again to combine with the other wave which has arrived via earth. These two waves add their effects to give the actual signal and, unfortunately for the dwellers in these districts, the combined wave frequently looks entirely different from the wave which started out from the transmitting station. The length of the extra path continually varies with atmospheric conditions and thus the amount of interference of the two waves with each other continually changes. The result of this interference is to make the signals so badly distorted as to be sometimes unrecognizable. A photograph of the signal current received close to WEA, and another photograph of the signal current received in Westchester County, only a few miles away, are so different that one cannot be identified with the other.

An explanation of the extraordinary distortion which this radio current suffers, which Bown and his co-workers offer us, does but little at present to make the transmission better. Their work did show, however, that certain improvements are possible at the transmitting station which will make the distortion somewhat more constant that it is at present, but that won't help the broadcast listener very much. It appears to be a fact that certain districts will get bad transmission from certain stations and there is at present no apparent remedy for it.

### Radio Control for Railroads

IT HAS been recently announced that radio was doing much to accomplish automatic train control, which the Interstate Commerce Commission has ordered installed on all of the principal railroads. The scheme required by the Commission must automatically apply the brakes of a train which runs into a danger zone so that even if the engineer ignores the danger signals set against him, his train will be stopped before a wreck occurs.

Among the schemes which give promise of success is that which uses the two rails to carry high frequency currents. These currents, acting on a coil carried on a locomotive, will apply brakes, shut off steam, or whatever other operation is necessary. Tuned circuits are used on the locomotive so that different operations are carried out on the locomotive according to the frequency of the current in the track.

To be economically successful, it should not be necessary to feed the high frequency energy into the tracks at too many points, preferably only at one point in each block. But very high frequency currents will not travel far along the railroad tracks, for they waste away too rapidly. The radio

engineer trying to use this scheme must employ frequencies very low compared to those in which the listener is ordinarily interested. About 20,000 cycles (15,000 meters) is as high as is generally useful in the continuous train control scheme. The amount of power radiated from the tracks with such current is practically negligible. The tracks are really acting as the two wires of a power transmission line and there is no real radiation of power in the scheme at all. This "radio" system would probably operate as well or even better if there was no radiation, so that the scheme can scarcely be hailed as an application of radio. The frequencies useful are those used by the telephone engineer in carrier telephony, they are so low that even if there was appreciable radiation, no broadcast receiver, as used by the average listener, could possibly pick it up.

### Detroit Has a Good Radio Supervisor

WHEN the recent radio conference convened there appeared on the scene a real radio inspector properly equipped to do his job. Probably the most pressing duty of the government radio inspector today is to locate sources of interference and to do this with any degree of ease requires a portable receiving set. Supervisor S. W. Edwards, of the Detroit district saw the need some time ago and by shrewd application of the meagre funds furnished to the inspection service was able to buy and equip a portable radio laboratory. An enclosed truck was fitted up with all kinds of receivers, frequency measurers, and the like, so that wherever the truck may be, measurements of frequency, direction from which interfering

signals are coming, and so forth, can be readily made.

When complaint of interference comes into his office, Supervisor Edwards at once dispatches his portable laboratory to the scene and by direction finding apparatus, wavemeters, etc., locates the source of the trouble. He reports that in no case so far investigated has he failed to locate the source of interference.

### Is the Loop or Antenna Receiver More Popular?

A RECENT bit of propoganda by one of the manufacturers of loop sets, states that fifty-three per cent. of the public prefer loop sets to those operated from an antenna. Just where these figures came from is not stated but we were surprised at the conservative claims of this loop-set manufacturer. Why not say one hundred per cent. of us prefer loop sets—it would not be contradicted provided the qualifying clause were added "other things being equal."

Naturally people prefer loop sets. They don't have to bother with outdoor antennas coming down in a country snowstorm or with the obdurate city janitor when trying to put one up. Further the loop has directional qualities (except in some steel buildings) and this offers the possibility of cutting out undesired stations. Why then don't we all use loops? Because we can say in general that a set requires between one and two extra stages of radio frequency amplification to give as strong a signal with a

loop as with an ordinary antenna. Tubes cost money to buy and maintain. Furthermore tubes themselves give noise due to electrical irregularities in their behavior and when excessive amplification is used in a multi-tube set, these noises become quite apparent and sound much like static. Sets having eight or more tubes at times give a lot of noise even if the input circuit is shorted so that no static can get in. Until very quiet tubes are available at low cost the loop set actually works against quite a handicap when compared to the antenna set.

### A New Short Wave Ray Is Discovered

AT A recent meeting of the National Academy of Sciences, Dr. R. A. Millikan of the California Institute of Technology reported the discovery of some new rays of the greatest power. Doctor Millikan's name should be known to all radio enthusiasts because of his wonderful work in measuring the size and charge of the electron, the thing that evaporates from the filament of the vacuum tube and makes its operation possible. And when Doctor Millikan's announces a new ray the public may rest assured that he has one. Such an announcement is not to be confused with that of such exploiters as Grindell-

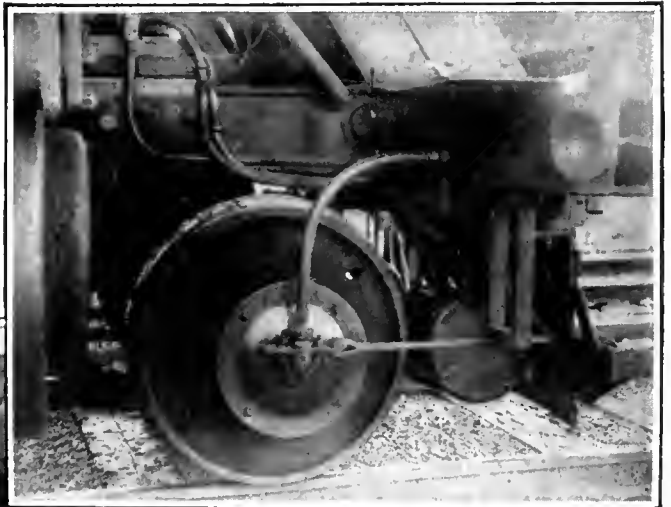
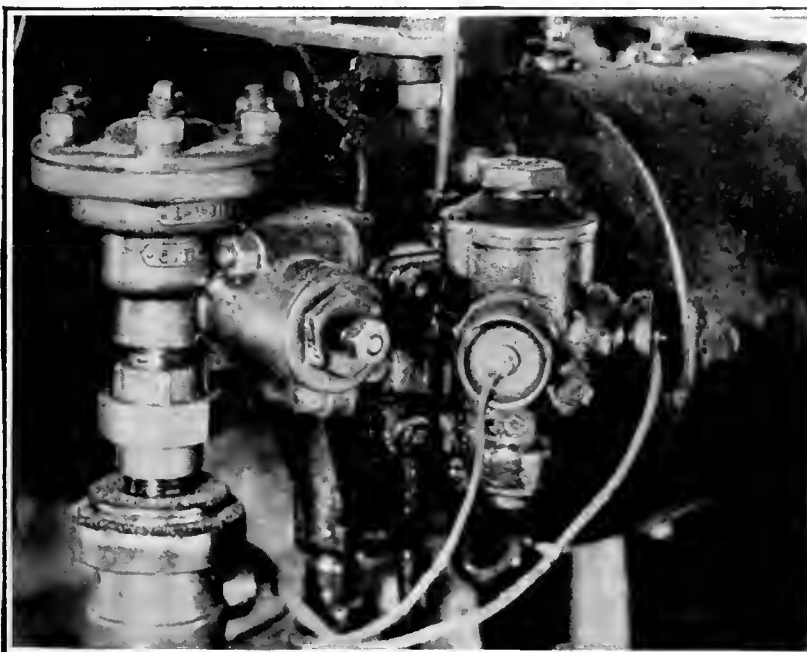

A RADIO TRAIN CONTROL SYSTEM

Developed by Thomas Clark of Detroit who, in the early days of wireless telegraphy headed a "wireless" company of his own. The control system is really not wireless but rather, "wired wireless," for high frequency currents are sent along the rails and used through the proper combination of apparatus to control danger signals in the engine cab and valves which will stop the locomotive. The view at the lower left shows a close-up of the valves which are worked by this "radio current" to stop the engine when desired. Above is shown the control device applied to the drive wheel of the locomotive. The smaller view shows a typical locomotive on the Pere Marquette Railroad which is experimenting with the system

Matthews, who gave to his fellow Englishmen the bad attack of ague some time ago when he announced his "death ray" which was to be sold to the French if his country wouldn't pay his price. This death ray, it will be remembered, was never proved to be at all valuable or effective.

Millikan has already received the Nobel prize for his scientific researches which marks at once any announcement he makes with the stamp of reliability. The new rays are of the nature of X-rays, he says, but perhaps one thousand times as powerful. They are discovered only at great height; he sent his measuring instruments up in balloons and only at ten miles height were the new rays found with intensity great enough to be recorded.

These rays fall in with the tendency of the times, by the way. The radio engineer every day hears of the increasing reliability of short waves. The shortest waves of radiation which the scientist has known until now are the X- or Roentgen rays. These new rays, christened Millikan Rays by the discoverers' fellow scientists, have a wavelength only one thousandth that of X-rays. Whether we shall ever be able to produce them on earth or use them after they are produced, is problematical, but the probable answer to the question is "Yes."

### The Ethics of Radio Advertising

**S**URELY when a novice looks over the radio advertisements with the idea of purchasing a receiving set, he must be greatly confused and misled as to what the different sets will do. Most extravagant claims are made for radio apparatus of any kind and price. Everything is the very best and when one adviser hits upon some

extravagant word with which to brand his goods all of its synonyms are sure to appear in the next issue of the periodical. Now, no matter what the manufacturer may say, we cannot believe that a forty dollar set is as sensitive, selective and as good in quality of reproduction as the hundred and fifty dollar set—yet the advertisements all say so.

Mr. E. H. Jewett, recently commented on the situation in the following way.

It (the radio advertising competition) has reached the stage where it is practically interchangeable, really almost cancellable. The race in superlative claims is so intense that most advertisements almost duplicate one another. One could interchange the corporate names and hardly destroy the purpose of the advertisement.

The majority of radio manufacturers are much concerned about the good name of their industry. It is essential to their purposes that when Mr. Ultimate Consumer shoves his money across the counter he gets value received. So the old admonition about letting the buyer beware is very apropos nowadays. Every radio purchase deserves personal investigation. Personal inquiry is the best checkup on too effusive advertising.

### The Month In Radio

**L**AST month saw the passing of two of our most promising radio engineers. Returning from the Fourth Radio Conference, G. Y. Allen, technical assistant to the manager of the radio department of the Westinghouse Company, was killed in a train wreck near New Brunswick on November twelfth. He was a

graduate of Stevens Institute, a member of several technical societies and was highly appraised by his company. "Mr. Allen's death means a great loss to the Westinghouse Company," said E. B. Mallory, his superior in the Westinghouse organization. "Brilliant as an engineer, indetigable as a worker, and of charming personality, it will be impossible to replace him."

Dr. H. W. Nichols, research engineer of the Bell Telephone Laboratories, died at his home recently after a brief illness. After getting his Ph.D. degree at the University of Chicago, Dr. Nichols joined the research staff of the Bell Laboratory and was



CAPTAIN E. P. ECKERSLEY

—London—

Chief Engineer, British Broadcasting Company; in a statement especially written for RADIO BROADCAST

"Based on our previous experience, the International Radio Broadcast Tests in January, 1926, should mark a distinct advance. It should be possible to secure with the assistance of the International Bureau de Radiophonie, more definite and accurate data on the programs of the broadcast stations on our side of the water than ever before. It is especially important to communicate to all listeners to the programs in these tests that there is five hours' difference in time, for example, between New York and London. The tests will start Sunday, January 24 at 10 P. M., Eastern Standard, or New York Time: that will be 3 A. M. Monday, January 25th, London time. The stations on our side of the water will begin their test programs at 4 A. M. London time, or 11 P. M. the night before, New York time. Our European schedule of transmissions is being settled at a conference in Brussels. We believe radio intelligently developed in the public interest is destined to become a potent auxiliary to international cooperation in bringing closer together broadcast listeners and wireless enthusiasts all over the world. Radio should perform invaluable work in establishing common points of interest and in consolidating conscious world citizenship without which there can be no assurance of permanent peace between nations.

largely responsible for the radiophone development carried on in this laboratory during the past few years. He was a member of several scientific societies, on the Board of Direction of the Institute of Radio Engineers and had been nominated for President of the Institute at the time of his death.

**T**HE Western Union Telegraph Company is not suffering much from the air mail and radio competition, as had been predicted; radio, the air mail, and the telephone, it has been claimed, constitute a real menace to the telegraph companies, but Newcomb Carleton, President of the Western Union, says they are allies of the



Courtesy New York Evening World

"HOW IS YOUR RADIO RECEPTION HERE?"

telegraph rather than competitors. The business of his company was three times as great last year as in 1914 and the profits have so increased that a three million dollar salary increase is to be granted to the employees and a fifty per cent. stock dividend probably declared.

**I**N A previous paragraph we spoke of the effusiveness of the radio advertiser and how slightly his claims are influenced by the truth. A recent advertisement of the Radio Corporation of America, under the attractive caption "How important is vacuum?" claimed for its engineers that they have succeeded in reaching a vacuum "ten million times greater than the vacuum of the high exhaust incandescent lamp"; the rest of the copy suggests that all of the R C A triodes are thus exhausted.

We think that Thomas F. Logan, Inc., the advertising agency concerned, will find upon inquiry that the engineers, capable as they may be, have succeeded in doing no such thing. The vacuum claimed is nearly a thousand times as great as the research men have succeeded in attaining unless some remarkable discovery, not yet disclosed, has been recently accomplished.

**A** BRITISH mail plane recently en route from Croyden to Paris encountered trouble, and anticipating a forced landing, called to both English and French stations for its bearings. These were promptly given and so the plane located itself. It had to come down on the water but was able to send its location with sufficient accuracy that after a few hours floating on the Channel it was picked up by one of the searching vessels. This is in contrast to the radio service the *PN-9 No. 1* secured from its own equipment and the destroyers placed in the Pacific to help guide it.

**T**HE Amsco Products, Inc. was recently sued by the Westinghouse Company and R C A for putting out sets which, it was claimed, infringed the regenerative patent.

The set was supposed to be neutralized, but, as the neutralizing condensers were adjustable, and instructions were given as to how the set might be made to regenerate, the judge decided that infringement had been accomplished and found for the plaintiffs. A special master has been appointed to assess damages.

**D**URING a recent talk in England, Senator Marconi stated that he and his engineers have not only found it possible to communicate with Argentina, from England, with only one-fifth of a kilowatt of power at 20,000 kilocycles (15 meters), but that he had actually found the communication more reliable in the daytime than in the night time. This is an entirely unexpected result as night time transmission has always heretofore established the long distance records.

*Interesting Things  
Said Interestingly*

**A. H. MORSE** (in *Radio: Beam and Broadcast*, published by D. Van Nostrand Company): "Unquestionably there is much that Britain and America may learn from each other in the matter of broadcasting, and it is certain that it would be an advantage if announcers in North America were required to satisfy a central authority as to the purity and standard quality of their diction, as they do in Britain. This done, there would soon be no point in the announcement of the facetious German shopkeeper, 'English spoken, American understood,' and the New York Eastsider might learn to articulate an 'r'."

**MAJ. HERBERT H. FROST** (Chicago; president of the Radio Manufacturers Association): "Listeners in America will never be called upon to pay a tax of any kind to support broadcasting, as is the case in some European countries. This will never happen in the United States for the reason that there are enough broadcasting stations owned and operated by the radio manufacturers to reach every part of the country. The manufacturer will, if necessary, pay for broadcasting, for his business depends on it."

**GEN. J. G. HARBORD** (New York; president of the Radio Corporation of America): "Broadcasting in South America is at present chiefly confined to the few large cities. Buenos Aires boasts of four stations. There are two stations in Rio de Janeiro, two in Sao Paulo, while smaller stations operate occasionally, one in Bahia and one in Pernambuco. In Chile there are two stations operating at Santiago. These stations, while perhaps not as powerful and well-organized as those of the United States, give a very fair degree of service in each instance though for the most part, the sched-

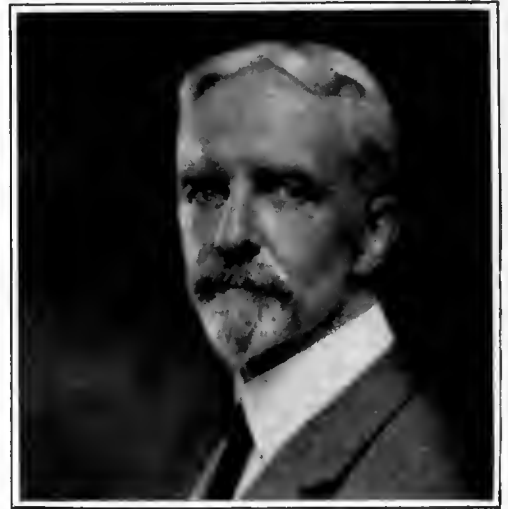

CHARLES GRAY SHAW  
—New York—

Professor of Philosophy, New York University, in an address "The Philosophy of Radio," through station wjz

*"Our interest in radio is as great a mystery as radio itself. There is no real reason why we should listen to sounds which come to us from afar, but we have our radio sets by the million and tune-in on anything. We listen-in without regard to the character of what is being broadcast. It may be an inferior soloist or a cheap minstrel singer, a bedtime story, or a college professor. If these artists were to hire halls they would perform before empty houses. But radio somehow makes it all different.*

*"How we love to listen-in. A pious old lady was found sitting enchanted listening to the report of a prizefight, round by round. A profane gambler boasted that on the previous Sunday he had caught a dandy prayer. These individuals would not have taken prize-fight and prayer in any way but the uncanny one of radio. How shall we explain this mad interest in the 'air'?"*

ules are well interspersed with phonographic music. In Buenos Aires excellent broadcasting is given the people during the operatic season when the opera is broadcast direct from the Teatro Colon.

"It is interesting to compare the 'radio coverage' in the countries, Argentine, Brazil, and Chile, with that of the United States. Here one station serves an area of roughly 6000 square miles, while in South America one station serves more than 300,000 square miles. From these figures, it is obvious that the South American broadcasting service is wholly inadequate, even in view of the fact that large sections are not extensively populated."

**BENNO MOISEWITSCH** (London; following his recent recital from 2 LO): "Alone in my room, sitting at the piano without coat, collar, or tie, with nothing whatever to distract my thoughts, I believe I can play better than on the platform. It was the same in the broadcasting studio. I found when I arrived there that a number of people were in the room, but, at my request, they were asked to leave. Then I took off my collar, tie and waistcoat and abandoned myself to my task.

"I was completely happy. There was no one near me save the operator, and the thought that, in my own way, I was entertaining an unseen audience of, perhaps millions, supplied me with all the inspiration I needed.

"It is a remarkable experience."



©Henry Miller News Pictures, Inc.

JOHN OCHACKI, JR. AND GEORGE SEEBER

Chief and Assistant Radio operators of the Clyde liner *Lenape* which caught fire off the Delaware Capes recently and was burned to the water's edge. Only one life was lost and passengers and crew numbering 367 were rescued

**R**ECENT conditions in radio broadcasting have resulted in new requirements for the design and construction of receiving equipment. The new frequency allocation of transmitting stations, and their increased numbers, have created the need for receiving systems capable of yielding a very high degree of selectivity. It is probable that the necessity will never be less.

Further refinements in mechanical detail and physical appearance of receivers have also made imperative the most compact internal construction. The radio set builder, confronted with the problem of selecting suitable elements for a receiver to meet the above requirements, has encountered many difficulties. Parts available for purchase have not been designed to overcome the handicaps to reception brought into being by these new conditions.

Radio inductances for commercial broadcast work have undergone only slight improvements in recent years and the purpose of this paper is to point out the need for advancement in this specialized field and to relate some developments which are thought to be new.

A tuned radio frequency transformer, or "coil" as it is often referred to, is recognized as being of great importance in any receiving system. Let us consider some of the characteristics of a radio coil which play an important rôle in the proper functioning of a receiving system in which it is used.

The efficiency of the coil has a very direct and significant bearing upon the receiving results obtainable. It has been stated many times that a coil should be designed so as to permit sharp tuning inherently; that is, its resistance to the frequencies for which it is intended should be as low as possible. Reduction in coil resistance is the fundamental design problem where selectivity is wanted.

Various engineering texts have defined coil efficiency in terms of the ratio of inductance to resistance. A coil, to be highly



## Design of Radio Inductances

Why the Conventional Inductances Do Not Meet the Electric and Mechanical Ideal—How an Electrically and Mechanically Desirable Shielded Inductance Was Designed and a Suggestion of Its Possibilities

By W. W. HARPER

efficient, should have as much inductance per unit of resistance as possible. There are certain limitations to the magnitude of this ratio, but it is reasonable to say that a radio coil for broadcast reception should be designed so as to permit an inductance of 25 or more microhenries per ohm.

### NECESSITY OF FIELDLESS CHARACTERISTICS

**T**HE need for efficient coils has been recognized for many years, but it is only recently that we have been forced to con-

broad in their tuning. At any rate, under conditions such as described, the receiver will appear to be just as broad as the broadest circuit. A non-regenerative detector input circuit in the ordinary tuned radio frequency amplifier system is an example of a broad circuit. It is possible, in many cases, to have other circuits equally broad, however.

So we see why it is necessary to design a coil which will not function as a "collector" or antenna. The logical solution of the problem seemingly resolves itself into a matter of confining the magnetic and electric fields of the coil. It is through these agents that this "pick-up" action occurs. The effect of unconfined fields is also detrimental from other standpoints.

Very compact construction of receivers many times necessitates the placing of other instruments in close proximity to the coil. Penetration of these bodies by electrical fields of the coil is usually accompanied by resistance increases within the coil. This is equivalent to saying that these adjacent objects have caused energy to be absorbed from the coil. This disadvantage will be eliminated if effective confinement of the coil fields is attained.

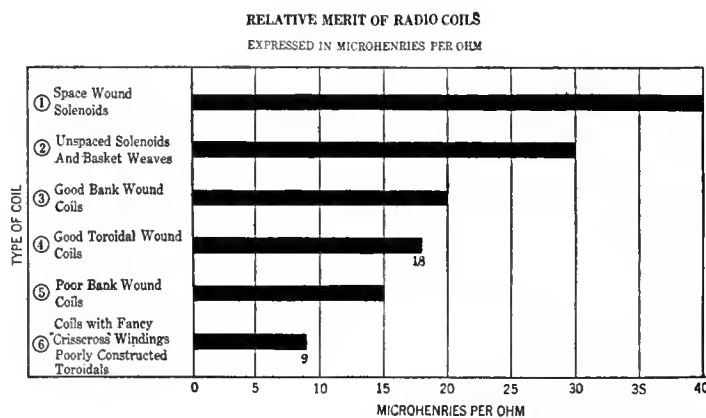

FIG. 1

One of the requisites of a good coil is that it have a large value of inductance per ohm. From this chart, showing graphically the results of tests conducted by Mr. Harper, it will be seen that some types of coil have distinct advantages in this respect over others. This chart should help to answer the question, "What is a good coil?"

sider carefully other factors.

It is known quite well throughout the radio industry that ordinary coils within a receiver may act as miniature antennas. Some of us have even disconnected the antenna and ground and used the coils themselves in this capacity in order to demonstrate the so-called merit of the receiver. If we had sufficient influence upon radio wave energy so that we could make it behave and enter the first coil only of a receiving system, then such a demonstration as mentioned would have a real value. It happens, however, that in a very unavoidable manner the radio energy impresses itself with tremendous speed upon all the coils in the receiver. Some of these coils may be in circuits which tune sharply, while others may be in circuits which are intentionally or unintentionally very

Inter-stage coupling phenomena has also been a drawback with the old type coils when attempts were made to construct receivers of small size. Effects of this kind also have their source in the electrical fields surrounding the coils.

The mechanical characteristics are also worthy of consideration. They should be of such nature that the inductance, resistance, and other electrical characteristics will be invariable whatever the minor mechanical stresses the coil is subjected to. This feature is doubly important in tandem control receivers where it is almost imperative to match successive coils so as to get identical characteristics in each circuit. The usual method of coil building where the insulation on the wire is relied upon for spacing of turns, is an example of constructional methods which must be discarded. Variations in the thickness of insulation produces similar variations in pitch of winding. This results in unfortunate variations in inductance and other electrical properties.

STANDARDS OF COIL DESIGN

IT SEEMS possible from the foregoing generalized considerations to set down definitely certain axioms of efficient radio receiving coil design. These may be stated as follows:

- (1) Low resistance over the broadcast frequency spectrum combined with as high a value of inductance as is permissible under the circuit conditions.
- (2) Effective confinement of the electromagnetic field.
- (3) Effective confinement of the electrostatic field.
- (4) Consistent mechanical and electrical characteristics.
- (5) Small physical dimensions so as to permit compact construction. (Points 3 and 4 also assist in this connection, for with the coil fields confined it is obvious that they may be mounted in closer proximity without harmful coupling.)

The first consideration is that of coil efficiency in terms of low resistance combined with maximum inductance. It is necessary to select the most desirable type of coil in this respect before any attempts at solution of the remaining factors are

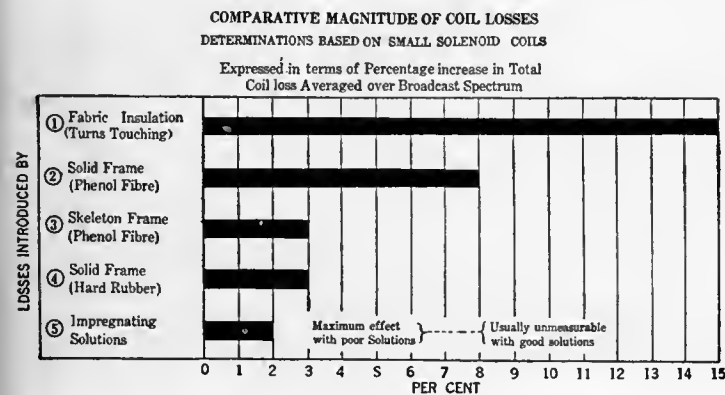

FIG. 2

From this chart it can be seen what effect the various factors entering into the winding of a coil have upon the finished product insofar as introducing losses in the coil and in the circuit in which it is used are concerned

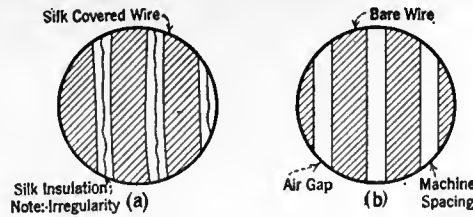

FIG. 3

The separation afforded between turns of a coil by silk insulation is apparently uniform, but when examined under a magnifying glass, its irregularities manifest themselves. In comparison, note the uniformity of spacing when a coil is wound by the aid of a machine which places each turn in position correctly. Uniformity of spacing of turns insures accurate calibration of coils on a quantity basis. Furthermore, by eliminating the silk or cotton insulation from the wires and employing a grooved cylinder, there is not the possibility of adding to the total of losses due to hygroscopic effects

made. Satisfactory results in any receiving system may only be anticipated when this requirement of maximum inductance per unit of resistance is reached.

In Fig. 1 is shown a statistical chart compiled from numerous tests conducted on various types of coils commercially available. The reader should not incorrectly interpret the significance of this data. It is well known that solenoid type coils can be so constructed that they offer greater values of microhenries per ohm than given on this chart. The same applies to all the types mentioned. The impressive point relative to the chart in question resides in the fact that the figures given are the results of averages made on measured observations of the characteristics of coils picked at random from the commercial market. The outstanding merit of the solenoid type coil is clearly apparent. This data in combination with other published works by various investigators seems to indicate emphatically the superiority of the solenoid inductance.

The fulfillment of the first requirement is therefore gained by the adoption of the solenoid type of coil, and if this were all, our problem would be a comparatively simple one. The further requirements, as listed, however, prevent such an easy solution.

The second and third points stated above require that the two field components be confined in order to eliminate or reduce "pick-up" effects and eddy current losses arising from too compact construction, as well as serious and unuseful coupling phenomena. It is therefore necessary to cast aside the usual solenoid and attempt to devise something more effective.

It is known that confinement of the electromagnetic field may be satisfactorily ac-

complished by the use of a toroidal winding. A step in this direction appears to be distinctly undesirable, however, for it is seen from the first chart that toroidal type coils inherently are less efficient than some other types. It would therefore seem that the satisfactory solution of one requirement which imposed a very noticeable loss upon another equally important one could hardly be considered the totally best solution.

It is also evident that the toroidals are incapable of meeting the entire problem of field confinement, since this form of winding has little or no effect upon the electrostatic field. The toroidal coil, is difficult to construct with the aim of satisfying the fourth requirement of electro-mechanical consistency.

NEW CONSTRUCTIONAL METHODS

THE desirability of the space-wound solenoid in respect to efficiency and the possibility of shielding it metallically suggested a much more satisfactory method of fulfilling the requirements we desire to attain.

It was reasonably safe to assume that a metal container could be used as both housing and shield for an efficiently designed solenoid. This belief, having been verified by experiment, led to the design of an inductance which is called the Metaloid.

Preliminary attempts to "screen," electrically, solenoid coils by metallic cans met with many misfortunes. A solenoid which had a very low resistance unshielded, would

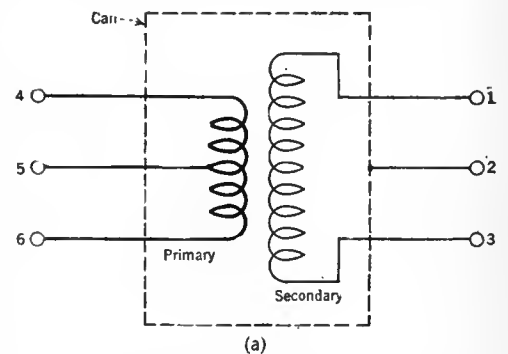

FIG. 4

The connections of the Harper coil unit. Below, the finished coil with "can" removed. The dimensions:

Primary: Form: 1 1/2" diameter, 3 1/2" long. Turns: 22, No. 28 D S C wire. Winding: Started 1/8" from top of form. Tap at 14th turn. Secondary: Form: 2" diameter, 3 1/2" long. Turns: 115, No. 28 Enamel covered wire in grooves separated by thickness of wire. Winding: Started 7/8" from top of form. Can: Size: 3" x 3" x 5". Cubic Volume: 45" cubic inches. Material: 12 oz. copper. General: Secondary-320 microhenries. Average resistance-9.5 Ohms. Approximate inductance per ohm: 33 microhenries Coil Form: Hard Rubber.



undergo tremendous resistance increase when "canned."

There are two obvious reasons for these failures. It was almost a radio legend that good solenoids could not be efficient if they were made smaller than, say, three inches in diameter. And true, when the diameter was reduced to two inches, the resistance increased at an enormous rate. The larger coils, however, could not be easily encased by a metal can. When the can was made of convenient size, the coil characteristics were harmed and by making the can of correct size to avoid this difficulty, it became of tremendous dimensions.

The second reason was due to lack of knowledge regarding the shielding characteristics of various metals.

Elimination of the first difficulty led to a careful analysis of the various sources of losses in small solenoid coils. The results of this investigation are depicted in the chart of Fig. 2, compiled after numerous measurements of various coil losses had been made.

The magnitude of losses introduced by insulation averaged as high as 15 per cent. and in some instances ran as high as 20 per cent. The loss effect in the framework and impregnating solutions, which have been thought to be of vital importance, dwindle to inconspicuous factors in view of insulation losses.

Insulation losses, of course, are reduced to a very low value by space winding so that an air-gap exists between successive turns.

The experiments leading to this discovery yielded the data necessary to proceed with the design of a small solenoid without the customary resistance increase. Eliminating the insulation immediately suggested the use of bare or enameled wire wound on a threaded hard rubber tube. Following in a fortunate sequence came the elimination of impregnating solutions, which are undesirable from both the standpoint of manufacturing and electrical efficiency.

It was also apparent that the framework

tubing could be machine threaded with great accuracy, thereby attaining electrical and mechanical constancy in every coil.

The Metaloid secondary is constructed along the lines mentioned above. It is approximately two inches long and two inches in diameter, space wound with bare or enameled wire in a machined groove. The inductance is approximately 320 microhenries and the average resistance is 9.5 ohms. This gives approximately 33 microhenries per ohm. These figures are based upon measurements made on the secondary coil encased in the metal can, which will be described later.

In Fig. 3 is shown a magnified comparison between coils in which the insulation is depended upon to give spacing and those in which the wire is space wound by means of an accurately machined groove in the supporting framework. Fig. 3A indicates the variations which arise because of variations in the thickness of fabric insulation. Fig. 3B shows the remarkable accuracy possible where the wire is spaced by a machine cut groove.

The second difficulty, that of selecting the proper metal as well as the determinations of the optimum dimensions for the can, was found to be more involved than one might anticipate, and a detailed *résumé* of the work done is not possible within the limits of this article.

It was found, however, that with the small solenoid previously mentioned, a four-sided metallic can approximately three inches square and five inches high, of ordinary 12-ounce copper sheet was satisfactory in all respects.

This arrangement apparently affords very effective confinement of both field components. Direct signal "pick-up" is very materially reduced as compared to other coils. It is understood, of course, that, due to pick up by other elements, this difficulty cannot be totally eliminated, unless the receiver is completely screened.

Audio-frequency transformers, sockets, and any metallic objects may be mounted directly against the can and no measurable eddy current losses occur.

Grounding the individual cans to the low potential secondary terminals of their respective coils entirely obliterates electrostatic potential gradients between successive coils. The four-sided can is also effective in nullifying inter-stage electromagnetic coupling.

The cubic volume of the can is approximately 45 inches. It should be remembered that this space houses the coil as well as its associated fields. While the actual physical size of the Metaloid is larger than average coils, it really takes up less space electrically, and may therefore be mounted more compactly.

The winding, which is seen in the photograph, is the secondary. The primary is mounted concentric and inside the secondary framework.

Fig. 4A is a schematic drawing of the Metaloid windings and connections. The primary is tapped as shown at 4, 5, and 6. This permits the use of large and small tubes as well as special circuit arrangements.

Contact to the can is independent of other connections and is made at terminal 2. In this way, the shield may be used either "grounded," or "floating." It is customary, however, to connect this terminal to the low potential end of the secondary winding.

The secondary terminals are indicated at 1, and 3. It was stated that the secondary inductance is approximately 320 microhenries. A variable air condenser having a maximum capacity of 250 picofarads (.00025 microfarads) will therefore be necessary to tune the coil to broadcast frequencies.

A new coil of this type appears to open up a broad field to the receiving experimenter, and in its correct application to receiver problems, many handicaps have already been met.

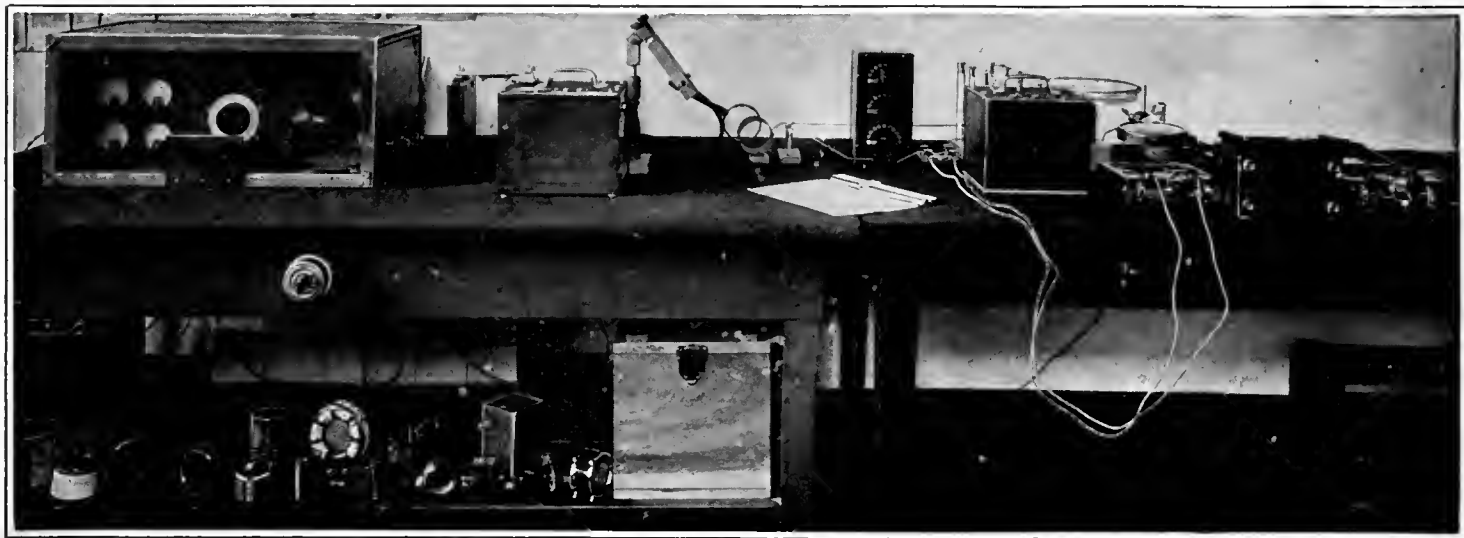

FIG. 5

This view shows the layout of apparatus used by Mr. Harper in making radio frequency resistance measurements of coils. At the extreme left is the radio-frequency oscillator, next in line is the wavemeter used to determine the frequency of the oscillator, and next the coupling coil. The coil being measured is the one resting on the block. It is connected to the resistance box and then to a microammeter through a thermo-couple. Note the magnifying glass suspended above the microammeter for precision readings. Other coils which have been tested are shown on the shelf in the lower left side of the photograph. The Harper coil is the high one to the left of the wooden box



# How to Build a Grimes Inverse Duplex

Constructional Details of a Four-Tube Receiver Which is Highly Selective, Built of Standard Parts, and Which Produces Signals of Irreproachable Quality

By FLORIAN J. FOX

LET us say in the beginning that the Inverse Duplex is not a specific circuit—it is a system which can be applied to any circuit in which both radio and audio frequency amplification are to be found.

Reflexing, which is the foundation of the Inverse Duplex system, permits one tube to function as both radio and audio frequency amplifier, and where it is employed in a

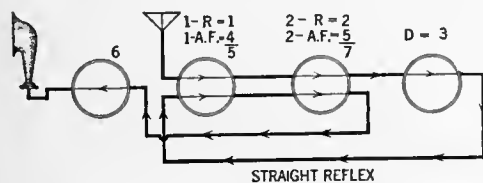

FIG. 1

Schematic diagram of a "straight reflex," circuit. The figures above show how the several tubes are employed to provide more than one kind of amplification

circuit, special attention must be paid to the function of various parts under differing conditions for instance, small condensers offer very little impedance to high frequency radio currents, but their impedance to current flow at the relatively low voice, or audio, frequencies is extremely high. In the case of inductances (transformer windings, choke coils, etc.) exactly the reverse is true. Circuits can therefore be so arranged that they discriminate against low frequencies in favor of the radio frequencies and vice versa. These principles are used in reflexing. Radio and audio frequency voltages are applied simultaneously to a tube, and since tubes work practically as well at radio frequencies as at audio frequencies, both the applied component voltages are amplified. By means of an appropriate circuit arrangement of coils and condensers, these amplified components are separated in the output circuit of the tube. In a properly designed reflex system, the presence of the audio system has no harmful effect upon the efficiency or "sharpness" of the radio circuit.

The Grimes Inverse Duplex is really an inverse reflex system. By that we mean

that the reflexed audio signals are passed through the amplifiers in a direction opposite to that of the incoming radio signals. The simple sketches, Figs. 1 and 2, illustrate this point.

The Inverse Duplex system is superior to the straight system in several ways. It is more stable because any radio frequency energy which may pass the detector and first audio transformer through capacity coupling will only be impressed on the input of the stage ahead of the detector, instead of two or more stages ahead of it as in the case of the straight reflex. In the latter case, oscillation due to feedback would be almost beyond control. In a

greater output volume level before overloading begins. In the sketch, Fig. 2, we have assumed that each stage has an amplification of one unit. The sum for any one tube will represent the load that it carries.

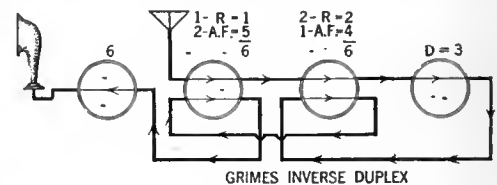

FIG. 2

A sketch which shows schematically how the Grimes Inverse Duplex system works. The tubes are shown in the order in which they are employed in the set and the figures above indicate their functions

FOR those constructors who are interested in building a receiver which is efficient and very sensitive, which employs no regeneration, the Grimes Inverse Duplex receiver described so completely in the accompanying article should appeal very strongly. This set is selective, a virtue not present in many simple reflexed receivers, and delivers tone quality of a high order, because the transformers selected for use in the audio channel are of excellent quality and the design makes best use of them. The filament and plate current drain with four storage battery tubes suggested for the circuit is fortunately low. Every part of the circuit can be made by the home constructor, for complete details of the coil construction are given, an important point, since many experimenters desire to make their receiver, as far as possible, with their own hands.

—THE EDITOR.

straight reflex receiver the first radio tube is usually also the first audio amplifier. Therefore if any audio frequency noises, such as hum from power lines, are induced



RADIO BROADCAST Photograph

FIG. 3

How the Inverse Duplex Model receiver looks from the outside. Three main tuning controls, which read almost the same for each station tuned-in, take up the major portion of the panel. On the lower portion of the panel, from left to right may be seen the output jack, series antenna resistance for controlling volume, audio amplifier switch, and rheostat. In the accompanying article it is explained how the series antenna resistance is eliminated from the circuit and in its place is substituted the antenna tap-switch which is shown in other photographs

One of the greatest advantages of the Inverse Duplex system is its economy of tubes and battery power. This is especially apparent if the receiver is to be operated by means of dry batteries, either in part or entirely. In the set to be described, if 201-A tubes are used throughout, the A battery drain is only 1 ampere. If a 90-volt B battery is used in connection with a  $4\frac{1}{2}$ -volt C bias, the total B drain from the amplifiers will be only about .009 amperes (9 milliamperes). Since the drain on the detector battery will be less than 2 milliamperes, even a small battery should last about a year at this point. This set properly handled will enable the user to get results equal to that of a six-tube set. This should have a strong appeal to those fans who like to get greater distances on less tubes or "more miles per ampere."

Looking into the set in the normal manner the tube arrangement

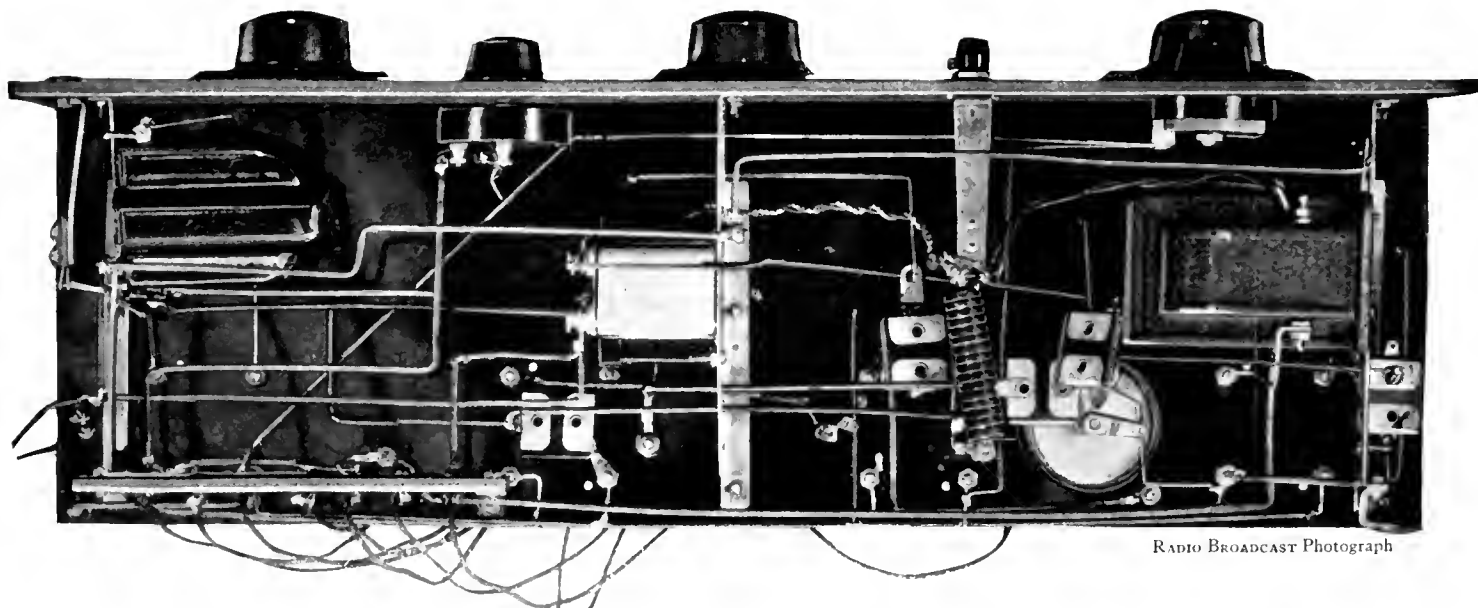

RADIO BROADCAST Photograph

FIG. 4

In this bottom view of the sub-panel, the important feature to observe is the location and distribution of the three audio transformers. Three brackets support both sub-panel and transformers. The variable resistance unit located directly below the Rauland Lyric transformer is the stabilizer

is as follows: (from left to right) 1. Third audio, or power amplifier; 2. First radio and second audio; 3. Second radio and First audio; 4. Detector.

The table printed with this article contains a list of the parts used in the construction of this model.

If a certain amount of good judgment is used in the selection of the materials, parts made by other reliable manufacturers may be substituted. For good results one must use dependable parts.

Since most experimenters know how to build sets, we shall not spend too much time in describing constructional details.

Fig. 8 shows the general panel layout. The dimensions given should be followed rather carefully, otherwise considerable difficulty may be experienced later when the set is to be mounted in its cabinet. Only the holes for the condenser shafts are shown because the mounting holes will be different for different makes of condensers.

Fig. 10 shows the layout of the inside sub-panel. On account of their height, it will be necessary to remove the bases of the Benjamin sockets. The base is then used as a template for drilling the four spring terminal holes. The sockets may then be mounted on the sub-panel as shown in Fig. 12.

As for mounting the vernier dials, directions are generally given by the manufacturer of the dial. If Hammarlund condensers and National Velvet dials are used, it will be necessary to remove the friction drags supplied with the condensers and to cut off a half inch or more of the condenser

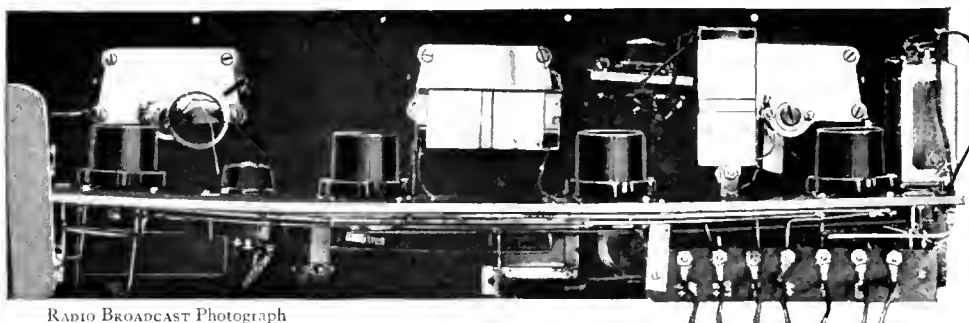

RADIO BROADCAST Photograph

FIG. 5

The coil units located in front of each tuning condenser are mounted so that their axes are aligned at right angles to each other. On the extreme left may be seen part of the grid leak which is shielded by the copper strip

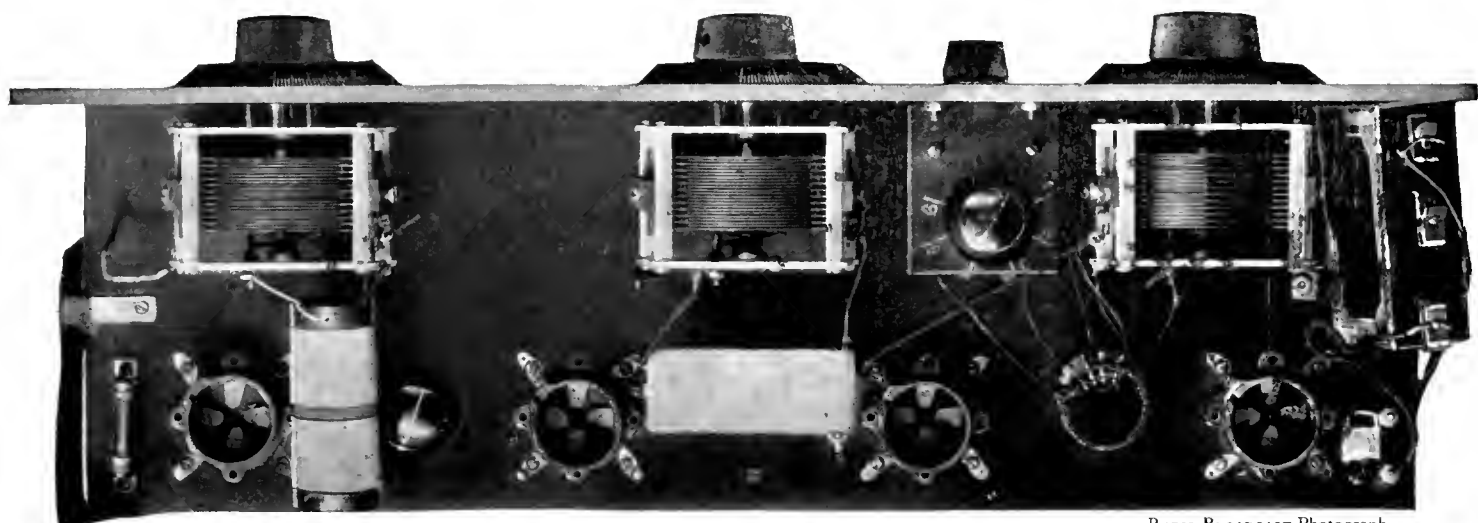

RADIO BROADCAST Photograph

FIG. 6

A top view of the receiver which will be of further aid to the constructor in placing the parts mounted above the sub-panel. As explained elsewhere, the antenna coil tap-switch situated between the two tuning condensers at the left is placed in the regular model directly on the main panel

shaft. It would probably be easier to buy National condensers complete with dials. There are, of course, other good vernier dials on the market which the constructor may favor. We suggest that the builder consider the purchase of a set of straight line frequency condensers for this circuit for they help to spread the tuning points of the higher frequency (short wave) stations, found at the lower end of the dial.

There are quite a large number of concerns that make radio-frequency transformers for use in tuned radio frequency circuits. Since it is difficult to advise the builder how to choose between them, we suggest that he copy the coils that we have designed. The diameter of these coils is small. This concentrates the magnetic field and thus reduces magnetic feed-back. Also, since the voltage per turn is low, the distributed capacity is very low. The resistance is not appreciably increased and the result is a coil which tunes very sharply. Let us now describe its manufacture.

The winding form is a bakelite or formica tube  $3\frac{1}{2}$  inches long and  $1\frac{3}{4}$  inches in diameter. A  $\frac{1}{2}$ -inch space is left in the center of the secondary winding. In this space the primary is wound. Before winding, drill all necessary holes for mounting-brackets, terminals, and anchor holes for

the ends of the windings. Then make a cut with a hack saw in the middle of the tube, and at an angle of about 45 degrees to the axis of the coil. Now begin the secondary winding in such a direction that this saw cut can be used for leading the wire across the  $\frac{1}{2}$ -inch space reserved for the primary. The secondary is wound with No. 28 d.c.c. wire. The total winding length is  $2\frac{1}{4}$  inches or the equivalent of 90 turns. The primary is now wound in the same direction as the secondary and consists of 15 turns of No. 32 or 34 d.c.c.

wire. Two such coils are made. The remaining, or antenna coil, has a primary of 25 turns (same size wire as the other primaries) tapped as follows: 2 turns, 4 turns, 8 turns, 15 turns, 25 turns. The beginning of this winding is connected to ground, and the taps are connected to points on the inductance switch. This arrangement provides both a volume and selectivity control. Decreasing the number of turns by means of the switch will decrease the volume and increase the selectivity of the receiver. See Figs. 6 and 9.

BUILDING THE R.F. CHOKE COIL

THE radio frequency choke coil shown in the wiring diagram of the receiver is absolutely necessary. Since there are none available on the market, this piece of equipment will have to be made. The choke coil described is the best we have been able to devise. It consists of about 20 separate windings all connected in series. Spacing the windings in this manner lowers the distributed capacity to such an extent that its presence across the tuned circuit does not affect the setting of the tuning condenser.

If the builder has no lathe, he can have the form made in a machine shop, or by a hard rubber turning company. The form is a piece of hard rubber, hard wood, or bakelite, 3 inches long and  $\frac{1}{2}$  to  $\frac{3}{4}$  inches in diameter. Slots  $\frac{1}{8}$  of an inch wide are cut to a depth of  $\frac{1}{8}$ -inch. The slots are spaced  $\frac{1}{8}$ -inch apart. This will enable the cutting of about 20 slots altogether. A saw cut is now made along the form parallel to its axis. This will be used for leading the wire from a filled slot to the next empty one. Fill each slot with No. 36 d.c.c., or better, d.s.c. wire. The ends of the wire may be later soldered to lugs that can be screwed to the ends of the form. An easy way to wind a choke coil is to drill into the dead center of one end of the form for a distance of about one inch and leave the form on the drill. Then clamp the breastdrill in a

The Facts About This Receiver

No.	NAME OF PART	MAKE OR KIND	OTHERS RECOMMENDED
3	.0005 mfd. Variable Condensers	Hammarlund	Any good make
3	4" Vernier Dials	National Velvet	} Any good make
3	Radio Frequency Transformers	Home made	
1	6:1 Audio Trans.	General Radio	Amertran, Karas high ratio
1	2:1 Audio Trans.	Thordarson	Jefferson 1½:1
1	Rauland Lyric Audio Trans.	Alt Amer. Trans. Co.	Amertran 3½:1
1	Panel 7" x 24"	Formica	} Any good make
1	Sub-panel 7" x 22½"	Formica	
3	Panel Mounting Brackets	Benjamin	
1	Open Circuit Phone Jack	Carter Radio Co.	Any good make
1	Inductance Switch	J. W. Jones	Any good make
1	6-ohm Rheostat	United Scientific Laboratories	Bradleystat, or any good make
1	Double-pole double-throw Jack Switch	Carter	Any good make
3	.00025-mfd. Mica Condensers	Dubilier	} Any good make
3	.002-mfd. Mica Cond.	Dubilier	
4	Standard Sockets	Benjamin	Any good make
1	R. F. Choke Coil	Home made	
1	1000-ohm. Non-ind. Var. Resistance	Central Radio Laboratories	} Any good make
1	Radio Cabinet	Jewett Parkay	
	Wire, Screws, etc.		To suit builder

NAME OF RECEIVER: Grimes Inverse Duplex.  
 TYPE OF CIRCUIT: Two tuned radio amplifier stages, detector; two audio stages reflexed through the two radio stages; and one straight audio stage.  
 FREQUENCY RANGE: 512-1330 kc. (225-585 meters)  
 NUMBER OF TUBES: Four.  
 KIND OF TUBES: All UV-201A's.  
 FILAMENT CURRENT: 1.1 ampere at 5 volts.  
 TOTAL PLATE CURRENT: 9 mils.  
 APPLIED B VOLTAGE: Amp—90 V—Det. 22½ V.  
 APPLIED C VOLTAGE: 4½ volts.  
 SELECTIVITY: Sharp.  
 REPRODUCTION QUALITY: First Audio Good; last Audio Fair, with some distortion—controllable.  
 NUMBER OF CONTROLS: Three for tuning, one for filament, one for volume, one for quality.  
 PARTS EMPLOYED: contained in article.  
 CONSTANTS OF CIRCUIT: contained in article.



RADIO BROADCAST Photograph

FIG. 7

An external view of the commercial model of a receiver employing the Inverse Duplex system. The dial indicators are engraved on the panel with pointers revolving over a semi-circular scale

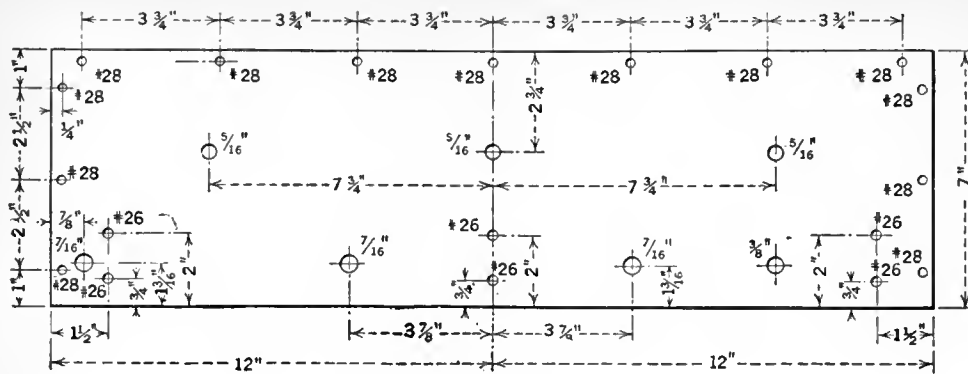

FIG. 8  
The layout for the main panel

wise in such a way that by turning the crank, the wire can be easily and rapidly wound on. Fig. 9 shows a sketch of the winding form.

If it is impossible to obtain the above form, some makeshifts may be devised. A dowel could be used and the windings spaced by means of heavy cardboard washers. It might even be possible to get fair results by using a long thread spool filled with wire. Fill the spool up as the winding advances, do not wind in layers. No mounting brackets will be necessary because the finished coil can easily be supported by the wires that connect to it.

The illustrations show the inductance switch mounted inside of the panel. This arrangement has been changed since the photographs were taken. The switch may be better placed where the small knob appears on the panel to the left of the middle dial. The unsymmetrical arrangement of the panel, as the photographs show, was due to a fear when this model was designed that the parts would be too crowded when the receiver was assembled. The fears were not well founded. However, the following change from the photographed model is suggested: Do not mount the rheostat under the third dial. Install a Bradleystat in the extreme lower right hand corner of the panel, in a position corresponding with that of the jack in the lower left hand corner. Do not change the position of the double-pole double-throw jack switch. The increased length of the audio transformer leads might cause the set to howl.

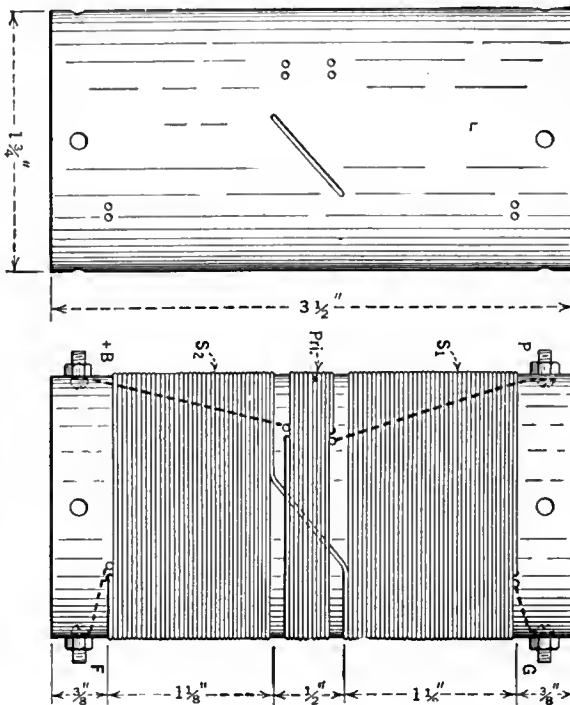

FIG. 9  
A detail drawing showing how the coil forms for the radio-frequency transformers are prepared and wound

Before using the sub-panel brackets, drill holes in the sides in such a way that an audio transformer can be mounted to each one. Study the photographs carefully in order to get the correct order and approximate position of each transformer on the brackets. Notice that the General Radio transformer is at the left, the

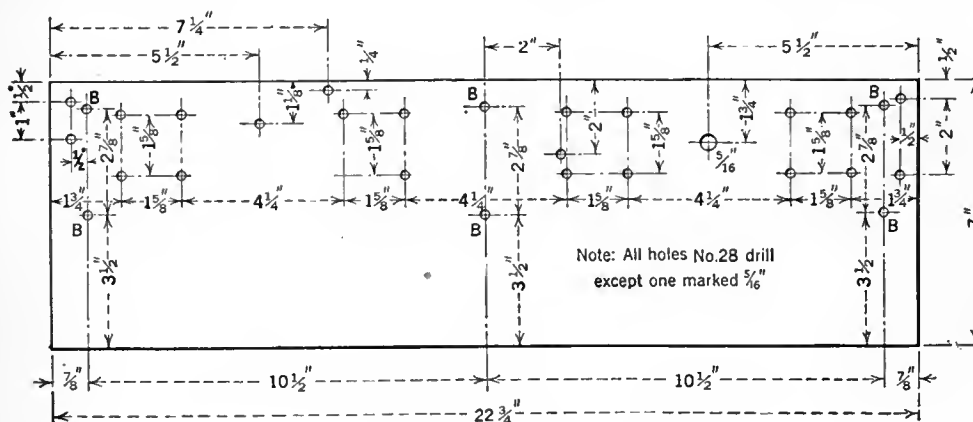

FIG. 10  
The sub-panel dimensions

Thordarson in the center, and the Rauland Lyric at the right of the receiver. Before drilling the bracket holes in the sub-panel (marked B in Fig. 10.) check the distances between holes and between holes and panel.

DETAILS OF CONSTRUCTION

**H**OLEs will also have to be drilled, before wiring, in the sub-panel to allow for the passage of the condenser and coil leads through it. The location of the holes is not shown. These may be drilled where convenient. Wherever possible, use one of the coil mounting brackets for bringing one of the coil leads through the sub-panel.

The brass brackets which are used to support the coils are shown in Fig. 11.

The grid leak mounting clips used in this model were obtained from a Daven grid leak holder. This is perhaps an unnecessary expense, because these parts can be easily made from a piece of spring brass. The clips are fixed to the top of the sub-panel in order that the grid leak be easily accessible. If this feature is not desired, a grid leak and condenser may be mounted beneath the sub-panel, where it is out of sight.

Notice also in the photographs that a brass bracket is made to support the end of the binding post strip that is not supported by the left hand panel mounting bracket.

The C battery and its terminals are placed at the extreme end of the sub-panel. In the model of the Inverse Duplex shown a small spring brass bracket was used to hold the battery against the cabinet. The hole for this is not shown.

The 1000-ohm variable stabilizing resistance, since it is not to be considered a control, is mounted on

the sub-panel where it is accessible for adjustment. In order that this stabilizer

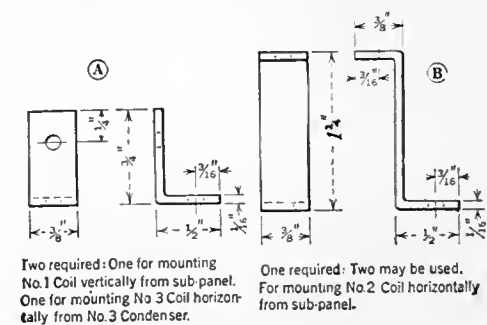

FIG. 11  
Details of the coil mounting brackets

may work properly, the primary of the second radio frequency coil *must* be reversed as shown in the wiring diagram. If this is not done, the stabilizing resistance will make the set oscillate badly.

The double-pole double-throw jack switch changes the set from a six-tube to a five-tube outfit (theoretically) by cutting in or out one of the audio-frequency stages.

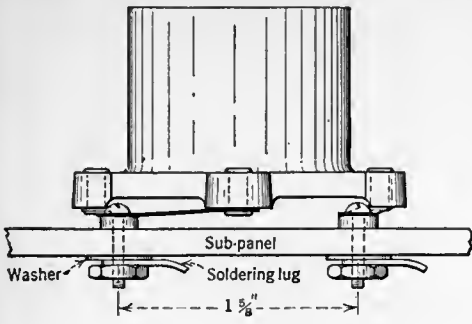

FIG. 12

The assembly for the Benjamin sockets

A switch that has a fibre cam should be used if possible.

If other makes of audio transformers are chosen, insist on two low ratio transformers for the two reflexed stages. Use a high ratio in the last free audio stage. This will insure good quality in this circuit.

Because of the sub-panel construction it is not necessary to waste time in fancy wiring. This will appeal to a large number of home builders. Avoid large closed loops in the wiring of the audio circuits. Wherever possible, twist the wire with its return. That is, in the case of the wires connecting an audio transformer, twist the plate wire with the plus B wire and the grid wire with its minus filament wire. This helps to reduce the tendency for audio feedback which is very great with three stages of audio amplification. Notice also that the third audio tube is placed as far away from the detector tube as possible.

Do not allow the output wires from the third audio stage to run anywhere near the detector tube or its grid leak and condenser. The grid leak and condenser should be mounted as close to the detector grid as possible. This is very important in a set employing this circuit. In the set described, a grounded metal shield has been placed near the grid leak and condenser and the detector tube. This helps considerably in shielding these parts which are extremely sensitive to induction from various sources, such as electric light wires, trolleys, small motors, and so on. It is also desirable

to ground the brackets which support the sub-panel and the audio transformers.

For best results in Inverse Duplexing, there is a certain definite way of poleing the primaries of audio transformers. A technical explanation of this statement is not necessary in this article. The circuit shows the best arrangement for the transformers used. If transformers of a different make are used some experimenting will perhaps be necessary in order to determine whether the primaries are to be connected as marked or reversed. All transformers do not have their primaries marked in the same way.

For local, or perhaps moderate distance reception, it is possible to dispense with the antenna and substitute for it a loop. The loop is connected in the circuit in place of the first secondary tuning coil. It can be so arranged that by means of a double-pole double-throw switch, the loop is connected in the circuit in place of the antenna system. By no means can it be expected

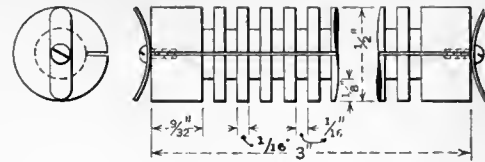

FIG. 13

Specifications for making the choke coil forms

that the loop will prove as satisfactory as the antenna where only distance reception is to be considered, but the constructor will note that with its use there will be a freedom from the usual collection of noises that find their way into a receiver via the antenna.

The circuit is quite stable in operation when UV or UX-199 tubes are substituted, but when this is done, it is well to employ a power dry-cell tube such as the UX-120 in the last audio stage to prevent overloading which results in distortion.

Builders often experience a certain amount of difficulty in constructing a set of entirely new design. We shall outline some of the troubles that may be experienced, and how to locate and correct them.

### HOW TO LOCATE AND REMEDY TROUBLE

THE first indication of trouble is usually a howl of some kind. These can be divided into three main classes.

1. AUDIO HOWL. This is a steady high pitched sing which is absolutely independent of dial settings. It may be caused by: (a) audio feedback due to wiring; (b) audio feedback due to common resistance in old B batteries; (c) use of a common detector B battery.

In this set, a separate small 22½-volt battery must be used for the detector tube except when storage B batteries are used; (d) long detector grid lead; (e) the proximity of a loud speaker or loud speaker cord to the detector tube, or to its grid leak and condenser; (f) improper shielding of audio transformers; (g) open grid circuits. Look the set over carefully and check everything except (a) and (f). If the howl still persists, there are only two things to be done; rewire the set, or load the secondaries of the audio transformers. Try placing ¼-meg. or 1/10-meg



RADIO BROADCAST Photograph

FIG. 15

The three dials on this panel seem to be similar to those on any number of sets, especially those of the two-stage tuned radio frequency receiver. Actually this is a panel view of the new Kurz-Kasch E-Z Toon Group Control. By means of the center dial, all three tuning condensers may be rotated simultaneously. All three dials have verniers, permitting each condenser to be finely adjusted independently

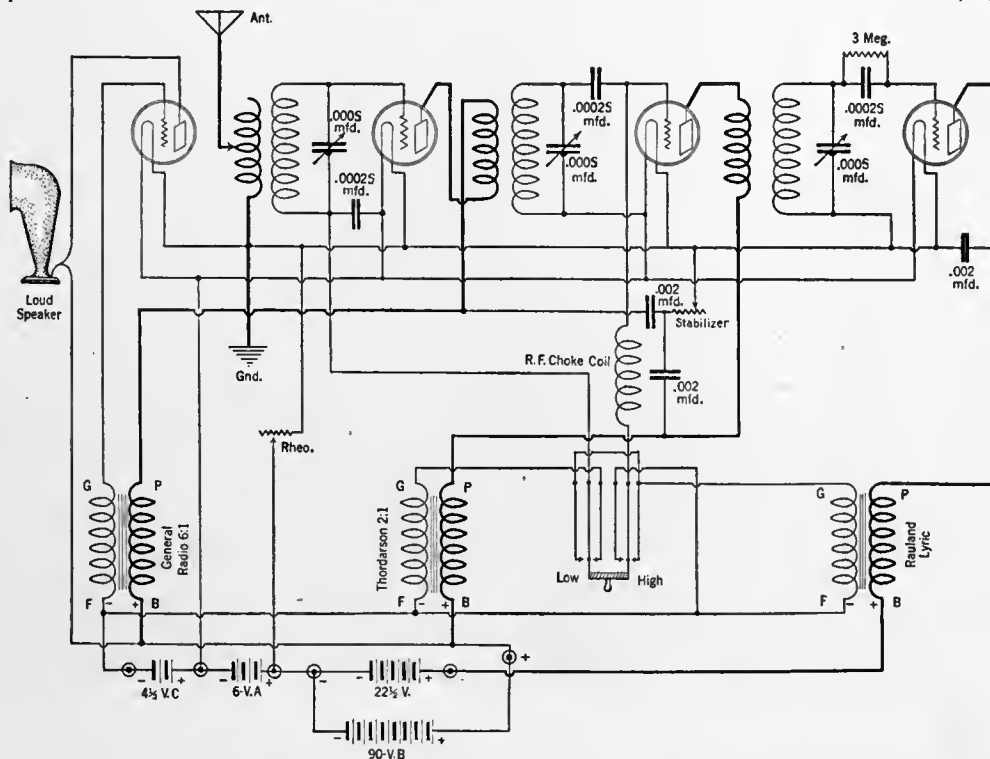

FIG. 14

The circuit of the Grimes Inverse Duplex. The first and last tubes are 3rd audio and detector tubes respectively. The other two are both radio and audio amplifiers

grid leaks across one, two or all three of the secondaries. This should certainly kill the howl. If it does not, the author would be glad to hear in detail by letter from constructors and we shall try to help you. The addition of these leaks, while it reduces the amplification, tends to improve the quality.

2. RADIO HOWL.

This is usually a very low pitched buzzing noise. It only occurs when two or three of the dials are set alike. Removing the antenna and ground tends to make it even worse. Radio Howl is caused by radio oscillation in the receiver. Radio oscillation, in turn, is caused by either electrostatic or electromagnetic feed-back between the radio-frequency stages. It may also be due to capacity feed-back within the tube. In any case, first make sure that the pri-

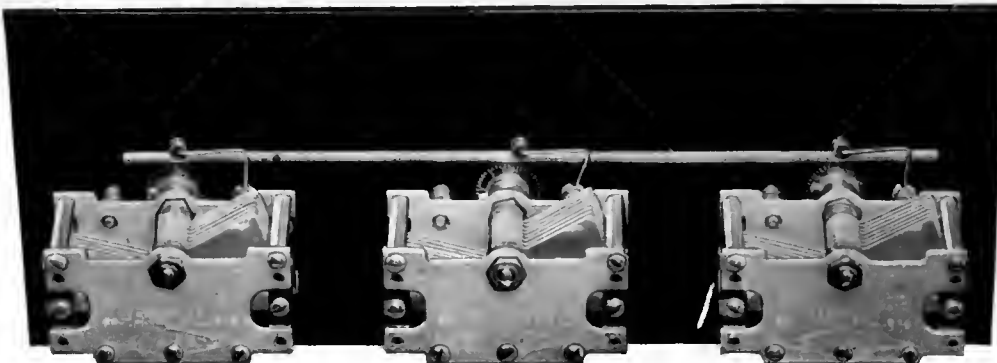

FIG. 16

RADIO BROADCAST Photograph

How the Kurz-Kasch arrangement works. By means of the rack and gears, one dial controls three condensers, an advisable simplification of the tuning of any set employing three condensers. This arrangement can be applied without difficulty to the Inverse Duplex set, and to many other types of receivers employing two stages of tuned r. f. amplification

mary of the second r.f. transformer has been reversed. Next cut in some of the stabilizing resistance, retune carefully, and repeat until no oscillation can be produced, even at the low dial settings. If the stabilizing resistance has no effect, the primary of the second radio coil probably has not been connected according to instructions.

3. OVERLOAD HOWL. The pitch is generally higher than that caused by Radio Howl. It occurs only when all three dial

readings are the same and when antenna and ground leads are connected. The removal of these leads stops it at once. Overload Howl is produced when the set is tuned-in to a very powerful local station. If the pitch is rather low and occurs before the volume reaches the overload point of the free audio tube as indicated by distortion, the audio transformer primaries are poled wrong. Try reversing them in various combinations until the Overload Howl is of rather high pitch. This is the condition for least overload. The receiver should now be capable of delivering volume up to the limit of the tube in the third audio stage. To avoid Overload Howl always cut out one audio stage when tuning-in to local programmes. The third audio stage should only be used when extra volume is desired.

## A PRIZE CONTEST FOR THE DESIGN OF A NON-RADIATING SHORT WAVE RECEIVER

SO GREAT has been the interest in the RADIO BROADCAST-Eveready experiments carried out at station 2 GY, and so many inquiries have come from readers who want to listen on the short waves, that the contest outlined below will serve many purposes. In the first place it will indicate that up to the present time there is no receiver which the Editors of RADIO BROADCAST feel that they can recommend. It will also indicate what these Editors, and the judges of the contest, believe an ideal short wave receiver should be. And finally, it will serve to awaken interest among the thousands of amateurs toward developing real honest-to-goodness receivers.

Perhaps a few words on the reason for the first statement will not be amiss. It may be remembered by many readers of RADIO BROADCAST that the clearest cut and longest standing policy of that magazine has been to frown on radiating receivers. It has consistently refused to publish how-to-make-it articles on receivers that were liable to interfere with nearby receivers, and it has endeavored in many ways to show owners of such receivers how they can make them innocuous and more efficient.

The second important point in this connection is the fact that there are at present about 20,000 amateur operators listening-in on the short waves, and practically all of them use very simple two- or three-tube sets, which are of the "blooper" variety. To encourage thousands of broadcast listeners to go down to the short waves with similar receivers would be contrary to our long established policy, and would result in a hopeless medley of meaningless parasitic signals on the higher frequency bands.

At 2 GY, the experimental station of RADIO BROADCAST-Eveready, a receiving tube with 180 volts on the plate has transmitted signals to Philadelphia, 100 miles away, under favor-

able conditions. Of course no receiver regularly uses 180 volts, but with 90 volts, there has been no difficulty in communicating over distances of ten miles and at that distance the 90 volt set produced very strong signals.

What is wanted is a non-radiating short wave receiver, preferably one that will cover all of the amateur bands, but most certainly the so-called 40, 80, 150 meter bands.

To aid possible contestants, the following schemes are suggested. A receiver with such loose coupling that the single oscillating tube cannot radiate; a simple receiver of the present type with a stage of neutralized radio frequency ahead of the oscillating detector; a super-regenerator with a blocking tube ahead of it; some simple form of super-heterodyne, such as the O'Connor frequency-changer described in RADIO BROADCAST for June, 1925. Such a receiver should be as efficient as present receivers, preferably it should be better. That is, it should go down to the noise level in places where a single oscillating tube will not do it.

The conditions of the contest are outlined below. In order to appear in the May issue of RADIO BROADCAST, complete specifications, photographs etc., of the receivers will have to be in the editorial office by the first of March, 1926, in order to be considered.

### THE CONTEST

**Object:** The object of this contest is to aid in the development of improved short wave receiving apparatus, so that the possibilities of high frequencies may be more effectively studied.

**Prizes:** First prize, \$250; Second prize, \$150; Third prize, \$100. Only one prize to a contestant.

**Eligibility:** Anyone interested in short wave reception is eligible to compete, though no prizes will be given to manufacturers making short wave receivers or parts therefor.

**Conditions:** Each contestant must submit a complete description, photographs and hook-up of a short wave receiver which does not radiate. The receiver should be adapted to the entire short wave band from 35 to 150 meters, although this may be accomplished by interchangeable coils. RADIO BROADCAST shall be permitted to request the most promising receivers sent to its laboratories, in order that the final award of the prize may be determined, after exhaustive tests. In addition to the prizes, RADIO BROADCAST shall be permitted to use descriptive matter, either in whole or in part, submitted by any contestant, at its regular rates.

**Determination of Prizes:** The winning receiving sets will be judged on a basis of points as follows:

Workmanship . . . . .	15
Simplicity of handling . . . . .	20
Ease of Calibration	
Freedom from hand capacity	
Independence of tuning and regeneration	
Low Cost . . . . .	10
Use of standard or easily constructed parts	5
Performance . . . . .	25
Overall amplification of signals	
Use in relaying	
Ability to use break-in	
Ability to cover foreign amateur bands	
Appearance . . . . .	15
Method of avoiding radiation . . . . .	10
Total	100

**Board of Judges:** The following constitute the board of judges: Boyd Phelps, Prof. Louis A. Hazeltine, Zeh Bouck, G. C. Furness, Arthur H. Lynch, Edgar H. Felix, Dr. Lawrence Dunn, and Dr. A. Hoyt Taylor.

The contest positively closes March 1 so that prizes may be announced in the May issue, appearing April 15. All correspondence and prize manuscripts must be addressed: Director of the Laboratory, RADIO BROADCAST, Doubleday, Page & Company, Garden City, New York.

# The Listeners' Point of View

Conducted by — John Wallace

## What Radio Programs Chiefly Need

**W**AS it Irvin Cobb who described in whimsical fashion the dire results of his attempt to reduce, by taking alternate steaming hot and icy cold baths? Whoever it was, he attests that it resulted in his developing a set of highly trained, trick pores, capable of opening or closing at the slightest provocation, or at no provocation at all. This double action, hair-trigger arrangement, he further averred, was no unmitigated joy, inasmuch as said pores used absolutely no discretion as to the proper time to do their stuff, being prone, nay even fain, to open wide on a brisk, six-below zero morning, or shut up, like offended clams, in a stuffy telephone booth.

Another disease, similar in causation, threatens at any moment to sweep across the continent, sparing Mr. Cobb perhaps, but reducing to mild insanity a large army of listeners-in. This scourge we dub *Radio-Emotionalis*—or perhaps better *Radio-Super-Emotionalis* (medical term for an insidious neurotic condition).

The hapless victim of the epidemic may be readily recognized. He will greet you

right cheerily enough, perhaps laughing boisterously the while. But a second later he will be weeping copiously on your shoulder only to relapse quickly into the belligerent, defiant attitude of one resolved to crush out the little white menace. This may, like as not, be followed by a period of calm, whilst the victim, with gently heaving chest, gazes off into space, a where-have-you-been-all-my-life look in his eye. Then he will cackle hideously and start tuning-in the buttons on your coat, whereupon you will take to your heels, unless, as is probable, you have by that time caught the disease, in which case you will make it a cackling duet accompanied by Miss Blaughk on the mighty Baldwin.

Which is reason enough for the Government to establish a colony on some isolated island and confine thereon, as menaces to the public health, sixty per cent. of all existing radio program directors.

The "bigger and better" radio stations have, in response to the nowise concealed wishes of the listeners, largely got away from the kaleidoscopic type of program. But a large majority of the jerk-water

stations, keeping abreast, as is their wont, with the times now three years passed, still persist in this nerve-wracking offense. An extra-horrible example of the kaleidoscope program runs something as follows:

- 8:00 P.M. Announcement. Name of station. Its street address and telephone number. List of pickle manufacturers and dance halls it represents. Name of announcer. Color of his eyes. Call letters of station. Slogan of station. Bright remark.
- 8:03 Valse Triste . . . . . *Sibelius*
- 8:07 (Same as 8:00 P.M.)
- 8:10 Itchy Foot Rag . . . . . *Joe Goose*
- 8:13 (Same as 8:00 P.M.)
- 8:16 Elegy . . . . . *Massenet*
- 8:20 (Same as 8:00 P.M. and repeated hereafter as frequently as possible)
- 8:23 Reading: "The Shooting of Dan McGrew"
- 8:29 Quartette: "Oh Lord Where Art Thou?" . . . . . *Larch*
- 8:36 Quartette: "Where's My Sweetie Hiding?" . . . . . *Ed Ock*
- 8:41 Solo: "Fly With Me" . . . . . *Verdi*
- 8:46 Address: "Swat the Fly" by Ald. Skink
- 8:51 And so forth.



BROADCASTING A CARILLON AT WJZ

On Sunday nights at 7 P. M., Eastern Standard Time, the carillon recently installed in the Park Avenue Baptist Church, through the generosity of John D. Rockefeller, Jr., is broadcast. The chimes sound much better on the air than they do to listeners nearby. There are many high buildings near the belfry and unfortunate sound reverberations occur. The view at the left shows engineers of wjz experimenting with the location of the microphone. Anton Brees, formerly assistant carillonneur of the famous Antwerp Cathedral, and now in charge of the New York chimes, is shown at the manual in the center view. The photograph at the right shows H. B. Glover, of wjz, installing the microphone above the bells

Well, yes, we'll admit that this is a slightly exaggerated example, but the inconsistent program, even in its mildest form, is very annoying. Unity is a quality inseparable from anything that is well constructed, whether it is a watch or play or a sermon or a railway station. We don't always consciously note the force that unifies an otherwise heterogeneous collection of miscellany but we quickly and instinctively sense its absence.

Of course even a che-ild (that hypothetical youngster who, as shown in numberless illustrated advertisements, spends its infant years at pushing pianola pedals, running vacuum cleaners, operating Blum Bros. Cross Index Files, and cranking Tripco Trucks) could tell you that the above program was decidedly lacking in unity. But with the less flagrant offenders, the problem becomes a less evident one and its solution rests

finally on the taste and sense of the fitness-of-things of the program director. If he already lacks this sense the chances are he won't acquire it, and it would be better for the station to throw him out and get someone else.

Appreciation of Sibelius' *Valse Triste* requires that we be in a certain frame of mind. Likewise thorough enjoyment of *The Shooting of Dan McGrew* presupposes our being in a certain frame of mind. And the two frames are as dissimilar as passe-partout and carved ebony. The desirability of an audience being in receptive mood is so evident that it hardly needs to be stated. The overture that commonly precedes an opera constitutes a recognition of this truism. Containing as it does inklings of all that is to happen, it prepares the auditor for the three or four acts to follow and effectively bridges the gulf that exists between listening to music

and the previous occupation of the listener, be it clipping coupons, or punching a typewriter.

Even the movies take cognizance of this device. If, in one of the larger palaces, the feature film "Why Shoot Your Husband?" is shown, it will inevitably be preceded by an "opulent stage presentation" showing a chorus of bored wives engaged in target practice.

If the *Valse Triste* and *Itchy Foot Rag* are put on the same program, one or the other, or both, is going to suffer from the juxtaposition. The difference in mood between the two is greater than we can be reasonably expected to bridge.

But giving unity to a radio program does not, by any means, imply making it monotonous. Variety and unity are not necessarily antagonistic. Shakespeare, who was no ham at play construction, and who was a stickler for unity, didn't hesitate



IN THE STUDIO OF WRNY, NEW YORK

What probably is called a motley crew, peering through the plate glass window of the studio, inspecting Jerome Lama playing on the musical saw, an "instrument" capable of curious and unearthly melodies—as many radio listeners know from their own experience





DR. EDMUND A. WALSH

Vice President and Regent of the School of Foreign Service at Georgetown University who inaugurated the first radio school of international relations at station WRC, Washington. Conferences in this school are broadcast weekly by WRC, and test periods have been arranged for examination of listeners who enroll for the course

to introduce variety into his tragedies. He occasionally made use of the most sudden and violent contrasts. For instance the execrable pun pulled by Othello as he blows out the candle preparatory to smothering his wife, which, in 1926 version amounts to: "I'll douse this glim, and then, douse that one!"

If it's a joke it's a rather dismal one, and quite in keeping with the tragic mood. Thus Jarnefelt's *Praeludium* could be sandwiched in along side of the aforementioned *Valse Triste* with no disconcerting effects. For, though the one is riotously funny and the other mournfully sad, they are united by a common bond: both are music.

Mixing in a lot of fundamentally different things in the same hour's broadcast simply means that the edge is going to be taken off all of them. We can only give such a program the most superficial sort of attention and consequently derive a most superficial sort of enjoyment. If we were to try to get the most out of it by changing our mood as fast as the program director's whims we would expose ourselves mercilessly to the dread disease described above—*Radio-Emotionalis*.

The mixed program is doubtless the program director's honest effort to reach and entertain the maximum number of people of widely varying tastes. But in his attempt to please everybody he pleases nobody. Moreover, in considering it his duty to please everybody, he is flattering himself as to his indispensability; forgetting he is only one of the ten or twenty, or more, stations at the listener's command.

He performs no valuable service in offering variety, since it is the simplest thing in the world for the listener to get the variety himself, if he wants it, by tuning from one station to another. But if the listener, on the other hand, wants a uniform program, with no jarring inconsistencies, his only recourse is to tune-in on those few progressive stations on which he can count to deliver such a program.

And that is exactly what the listener does. Which is well. For in the long run it will mean that the hodge-podge program station will either come around to some sort of an organized presentation or simply waste its vaudevillian offerings on the thin air—which would not be economically advantageous.

So we would seem to have been tilting with a wind mill for the last several hundred words since all will right itself in time. But the sooner the better. The ideal

state of affairs will have arrived when each station adheres to one type of offering for at least sixty minutes on end. Then,

but not till then, we will be able to regard the faint snatch of something or other we hear flickering across our dials, as a fair sample of what that station is offering.

Under present conditions, we have more than once been fooled into patiently tuning-in a station because we heard a bit of a Brahms symphony (which, now that it is no longer the fashion to do so, we will admit we crave inordinately) and have been rewarded by the clear and perfect reception of *Palpatin' Mamma*.

### In Defence of the DX Fishers

THE Chicago district is, at present writing, engaged in a fearsome battle on the question of silent nights. One station has lingered on through months of warfare and refused to shut down on the specified night. Hence the fracas. While the recalcitrant station frequently asserts, with an air of injured righteousness, "We are considering the interests of the thousands of fans who, if no local station were in the air, would be



HOW WGY IS REBROADCAST AT WCAD, CANTON NEW YORK

Left to right: Harold K. Dergman, radio operator in charge at WCAD; Ellis L. Manning, announcer at WCAD, and instructor in physics at St. Lawrence University; S. E. Barber; Charles Geyh, control room assistant, and Prof. Ward C. Priest, chief announcer. The WCAD station is maintained by the students and faculty of St. Lawrence University and broadcasts on Wednesday evenings between 8 and 11 P. M., Eastern Standard Time, on a frequency of 1140 kc. (263 meters). The main features of the WCAD programs are rebroadcast from WGY at Schenectady, 175 miles away. The illustration shows the staff at the receiving station, picking up the WGY signals on their 192.2-kc. (1560-meter) wave

entirely deprived of radio on Monday nights, and the multitude of owners of large sets who can get outside stations, but who prefer to tune-in on local programs" it is transparent enough that it is playing the martyr for publicity purposes.

And, of publicity, it has received plenty in the controversy in the newspapers. One of the most amusing communications to the press was that of a lady who said "Indeed we do not want silent nights. We want to listen to the good programs in Chicago."

Any one familiar with the general run of Chicago programs should get a large ha-ha out of that!

But while we have not been inflamed by the controversy to the point of contributing to the symposium of nasty letters, it seems to us that were we questioned we'd advocate a silent night. Why not?

The thousands of fans who "would be entirely deprived of radio on Monday nights" could doubtless find something else to do. They didn't sit around thumb twiddling in the Before-Radio age.

We can't see why there should be any gnashing of teeth over the fact that the capital tied up in a station lies idle on silent night. There's many a large factory, representing an investment equivalent to a gross of broadcasting stations, that grinds forth no goods of a Sunday.

Moreover, why isn't the station's force entitled to a bit of a vacation at least once a week? Perhaps for some stations a two-, or even three-day vacation might be desirable. Who knows but that the program director, freed for the nonce from his duty of filling up the programs, might, during the enforced idleness, give birth to an original thought concerning said programs!

DX fishing has been pooh-poohed quite a bit by those who claim that it is a hold-over from radio's infant days. Its chief thrill they protest is merely (powerful word that "merely") the satisfaction gained in conquering vast distance. This, they go on to say, is silly; a perversion of radio's purpose, which is not to furnish geographical gymnastics, but to entertain.

Granting the fact that the largest use to which radio is put is to furnish entertainment in the home, and granting likewise that this will doubtless continue to be its chief attraction, we still maintain that its faculty of entertaining is not radio's greatest attribute. Its greatest potentiality is the conquering of distance.

Entertainment in the home is no new thing. We have always had Cards and Conversation. Pianos abound. Then there is always Charades or Post Office, to say nothing of Photograph Albums. Add to all these boons the Talking Machine and what more could you ask! Surely if radio's claim to admission to the Hall of Fame is on the ground that it has brought entertainment into the home, its argument is a feeble one. Cross Word Puzzle books could with as much right demand a pedestal. The unique feature of radio is not that it entertains, but, that it conquers distance. Every seeker after glory must pursue that chimera in his own line—not in the other fellow's. Hence it is in the conquering of distance that radio must achieve its laurels.

When we get a string quartette from Omaha we are getting nothing that we couldn't get out of a talking machine. But when we get an opportunity to sit in, by radio, on a national political convention, in session perhaps halfway across the continent, we are getting something we

never got before and couldn't get any other way. When (if ever) we are able to listen to some important history making event in a distant country, we are experiencing something undreamed of a generation ago. It is in service such as this that radio achieves its greatest purpose.

So to us the most potent argument for a silent night is that it encourages DX fishing. And by stimulating DX fishing it is stimulating designers and manufacturers to greater efforts toward perfecting long distance receivers. In short it is a step toward the development of radio's greatest and most valuable potentiality.

### Readings in Foreign Languages

AMONG the very few things that radio is actually capable of doing in the educational line is to assist in the teaching of foreign languages. Time and again we hear someone moaning "If I could only get someone to talk to me in French I could learn the language, but you know you can't get it all out of a book. You've got to hear it spoken."

We seem to remember that some years ago the broadcasting of lectures and readings in foreign languages enjoyed a brief vogue. But of late we have combed our dials assiduously and discovered a paltry few such offerings, generally in the form of lessons. In New York, WEAJ broadcasts a twenty minute French conversational lesson on Tuesday evenings conducted by Dr. Thatcher Clark of Columbia University and WNYC gives an hour on Monday, Wednesday and Friday evenings to elementary lessons by V. Harrison Berlitz in German, Spanish, and French. In Denver KOA contributes forty-five minutes a week to a conversational Spanish lesson on Mondays at 8 P. M. There are doubtless several other stations we have overlooked, but in all there is very little attention paid this excellent educational possibility.

There may be some question in the minds of program directors as to how widespread an appeal such an offering would have. Certainly it is true that there is no universal desire in this country to become bi-lingual. What if the most disreputable little newsboy in Rome can hawk his wares in three languages? He needs to. We don't.

But with the constantly increasing ease and decreasing cost of transportation to foreign strands, we, of America, are gradually going to find it more convenient to know other tongues. Moreover, the time is not centuries off when communication, via broadcasting, with foreign countries will be an everyday occurrence.

Besides there are already a goodly number of persons who would be interested in having an opportunity to listen-in on French or Italian or Spanish from time to time—persons who have struggled through Mr. Woman's or Otto-Onion's estimable grammars in their school days and have a foundation of knowledge which needs only exercise to become useful.



DOC HOWARD'S WKRC BROADCASTERS

Who are heard every Monday night from station WKRC at Cincinnati as a part of the "Kodel Mid-night Frolic." The entertainment includes this jazz orchestra, a male quartet, a whistler, and character monologuists

Such an educational program might take the form of a lecture on some current topic, given perhaps by an attaché of a consulate or by some first rate pedagogue. Or perhaps better it might consist in readings from some of the standard classics in the foreign tongues. Then the radio scholar would be able to sit with the book in hand and supplement with his eyes what he could not get with his ears.

The desirability of such readings or lectures being given by someone to whom the tongue is native, and who is possessed of the most perfect enunciation, is evident.

### Announcers as Automatons

SEVERAL readers have taken the trouble to inform us, and in no uncertain terms, that we are all wrong in advocating that the radio announcer be an automaton. We were assured that "no one wants to hear the plot of the opera to be broadcast read in the same monotonous voice that is used for stock market quotations." And we make haste to agree heartily.

When we urged that the announcer be an automaton rather than a personality-plus salesman of the radio station's wares, we had reference only to the announcer engaged in the routine business of labeling the next number and citing the name of the performer. We still think he should sink unobtrusively into the background.

The individual whose duty it is to comment at length upon the program (where absolutely necessary), to explain the music (where absolutely necessary), or to prepare us with some historical background (where absolutely necessary), is not, in the strict sense of the word, an "announcer." Call him a public speaker, if you will, or an "artist."

Of course he should have free rein to do his job in the best possible manner; though, unless he is the author, he should see fit to read the interpolations with only the inflection necessary to make them clear, spritely, and pleasant, and with no attempt to put his own personality forward.

But if, on the other hand, his observations are his own, he has a perfect right to put them across any way he pleases—just as he would do in ordinary conversation.

### Broadcast Miscellany

ACALL has been sent out by KFI to its receptionists to send in lists of old music dating from the Civil War period up to 1900. Plans are on foot in the Los Angeles station to review American music in a thorough and painstaking manner. Request is also made for copies of the old songs, songs such as "Climbing Up the Golden Stairs," "I'll Meet Her When the Sun Goes Down," or "We'll Paint the White House Green."

And, WKRC at Cincinnati performed a similar service in ferreting out folk songs

that have been preserved in the mountain fastness of Kentucky and are still played and sung in the cabins that are found in the clearings atop the mountains. This station arranged with the Cincinnati Post and the Rudolph Wurlitzer Company to send a musician on a trip through the hills to listen to, and record, the tunes—most of them unpublished. Among the songs, many of them two hundred years old, that were gathered together to form a broadcast program were: *Brother Green*, *Frog Went A-Courting*, *Lady and the Glove*, *Sourwood Mountain*, and the *Hangman's Song*.

H. V. Kaltenborn, associate editor of the Brooklyn Daily Eagle is on the air again Monday evenings from eight to eight-thirty through station WOR. His Current Events talks have been a popular feature of radio programs for the past three seasons. Mr. Kaltenborn interrupted the series last spring to make an extensive journey through Europe and the Near East in search of new material.

WITH the addition to its program of a new feature entitled "Things Talked About," which is presented every Friday afternoon by Mrs. Nina Reed, station WRC at Washington is now covering the weekly trend of current events for both its masculine and feminine audiences. Mrs. Reed's new series of weekly talks takes up the important events of the world that are of particular interest to women, and reviews those questions that are not covered by Frederic William Wile in his excellent weekly discussions of the political situation in Washington every Tuesday evening.

THE Uncle Charlies and other bed-time boys who persist in calling their juvenile listeners "kiddies" are, we suspect, some kin of the coy word-coiners who attempted to label the American soldiery in the late fracas "Sammies."

WHAT ho! we thought, there is much talk of how Music is insinuating itself into the Radio World. Let us see, vice-versa, how much of a ripple Radio is creating in the Musical World.

So we hied ourself to the public library and surrounded ourself with seven of the current musical publications. This, thought we, should be a fair enough index of the interest aroused among bonafide musicians by radio. Well, we shall chronicle the result of our research without comment: nowhere in the music trade journals did we find the word "radio" as much as mentioned. Which may or may not prove anything.

AN INTERESTING variation of the traditional ritual of announcing is that employed by WEBH, Chicago. For some time this station has been announcing only the "next number," omitting reference to the preceding one. Recently this

system was reversed and the practice now followed is to announce only the number just completed, after which the next number starts without any introduction. Either practice is commendable since it results in cutting the announcer's time on the air in half—and announcements, like subtitles in the movies, are best when brief.

Of the two methods, the one finally adopted by WEBH as a permanent practice has the most to commend it; for frequently a listener tunes-in during a number and is perhaps curious to know what he has heard.

This rule of omitting introductions is subject to exception. Where the importance of the artist, or the novelty of the offering, warrants it the announcement is made both before and after—for routine studio offerings the "back announcement" alone suffices.

SOME attention-caller, amateur or professional, ought to take it upon himself to inform these enthusiastic and breezy announcer-persons that g-e-n-u-i-n-e is not pronounced genuine. Concerts "broadcast direct" from some place or other, also leaves us exceeding cold. The logic of this last statement is positively astounding. Everyone is of course familiar with indirect concerts, and knows that the direct brand are vastly to be preferred.

THE editor of this department is pleased to hear from readers who agree or dispute his opinion. Those who write should address their letters to "John Wallace, Conductor, Listeners' Point of View, RADIO BROADCAST Magazine, Garden City, New York," and sign their communications.

IN TAKING stock of recent noteworthy additions to the broadcast listener's fare, we discover that the Radio Corporation of America stations have been responsible for at least two of the outstanding features on the winter's programs.

First in importance was the series of recitals from Steinway Hall, sponsored by Steinway and Sons. Such important musicians as Josef Hofmann, Guy Maier and Lee Pattison, pianists; Walter Damrosch and William Mengelberg, conductors; and Paul Kochanski, violinist, were heard in this series of one and one-half hour concerts broadcast through, WJZ, WRC, WGY, and WBZ.

Also of interest to many have been the Lewisohn Free Chamber Music Concerts broadcast from Hunter College, New York, every Wednesday night. The Chamber Music Series was founded by Dr. Henry Fleck and is still under his direction. They comprise the first course in musical appreciation offered to the public. In arranging the concerts, Doctor Fleck devoted the first part of the program to the classical school of writers, presenting them in chronological order. The second part has been reserved for modern works, however radical. Several excellent quartettes and trios have been heard in this series.

# FOUR RECEIVERS

*Each of Which Were Experimented With In Developing the "Radio Broadcast Universal"—Showing How Variations in Panel and Sub-Panel Arrangement Can Be Used to Advantage*

DUE to space limitations, it was not possible to show the readers of RADIO BROADCAST all the models of the popular RADIO BROADCAST "Universal" Receiver completely described in this magazine for January, 1926. A great many of these models were constructed while we were experimenting with the circuit in search for the final receiver. Several of the models which were not illustrated in our January number are shown here and it is possible for the reader to ascertain for himself the wide scope of application of this circuit to other designs. Other coil units, different panel and base layouts may be employed. On these two pages are shown several views and a circuit diagram of an excellent receiver which has points in common with the "Universal." We believe that many of our readers are

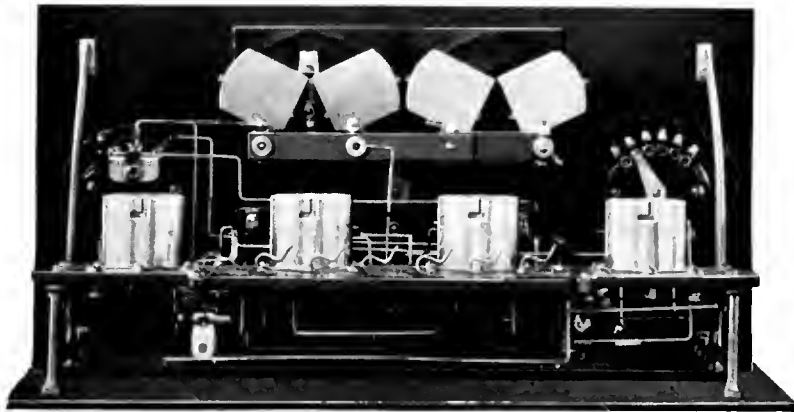

RADIO BROADCAST Photograph

FIG. 1

Rear view of the Phonograph model. Note the compactness of the unit which is made possible by using the Clarotuner coils and Hanscom single control unit

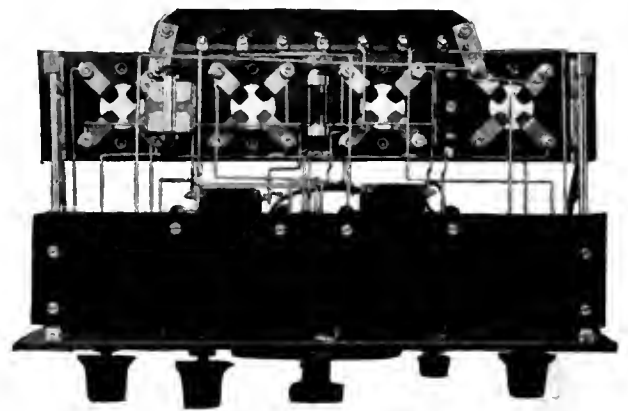

RADIO BROADCAST Photograph

FIG. 2

Bottom view of RADIO BROADCAST's Universal made to fit in a phonograph cabinet. This design is due to the engineers of the American Mechanical Laboratories and employs several departures from our original model to good advantage, including the Bruno Brackets which make for great rigidity in a compact receiver of this kind

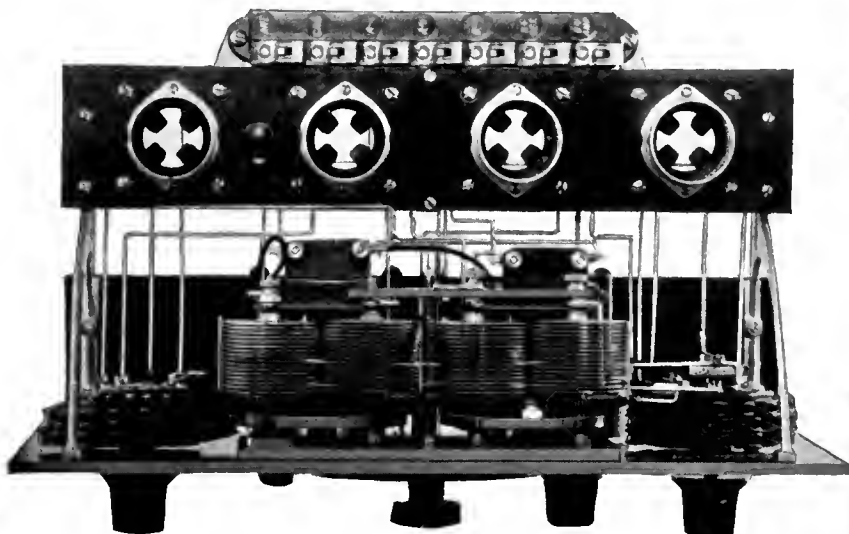

RADIO BROADCAST Photograph

FIG. 3

Top view of the same receiver illustrating the ease of assembly and wiring as well as the particularly neat appearance this form of assembly makes possible



RADIO BROADCAST Photograph

FIG. 4

A front view of the Sampson T C Receiver which has been developed by the Sampson Electric Company of Canton, Massachusetts, after a design of J. K. Clapp of M. I. T. This set is a very good example of the design adaptations possible in the Universal Receiver. The changes in the circuit employed are briefly covered in an accompanying illustration

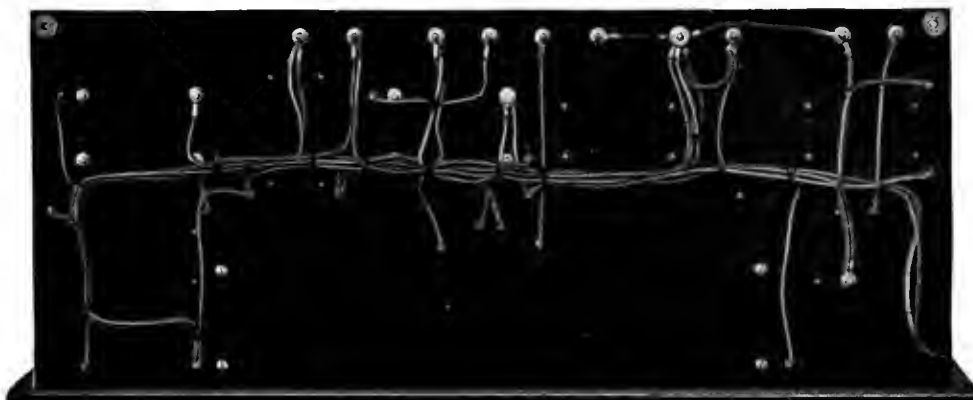

RADIO BROADCAST Photograph

FIG. 5

Cabling the wiring—when it is done intelligently—is advisable. Here is the base of the Samson and is a very good example of how it is done

undoubtedly familiar with this receiver, the Sampson T C, and for those who are not, it is shown here by illustration and circuit diagram.

The circuit diagram for the "Universal" Receiver is found on page 331 and the six pages following of RADIO BROADCAST for January, 1926.

Public Library,  
Kansas City,

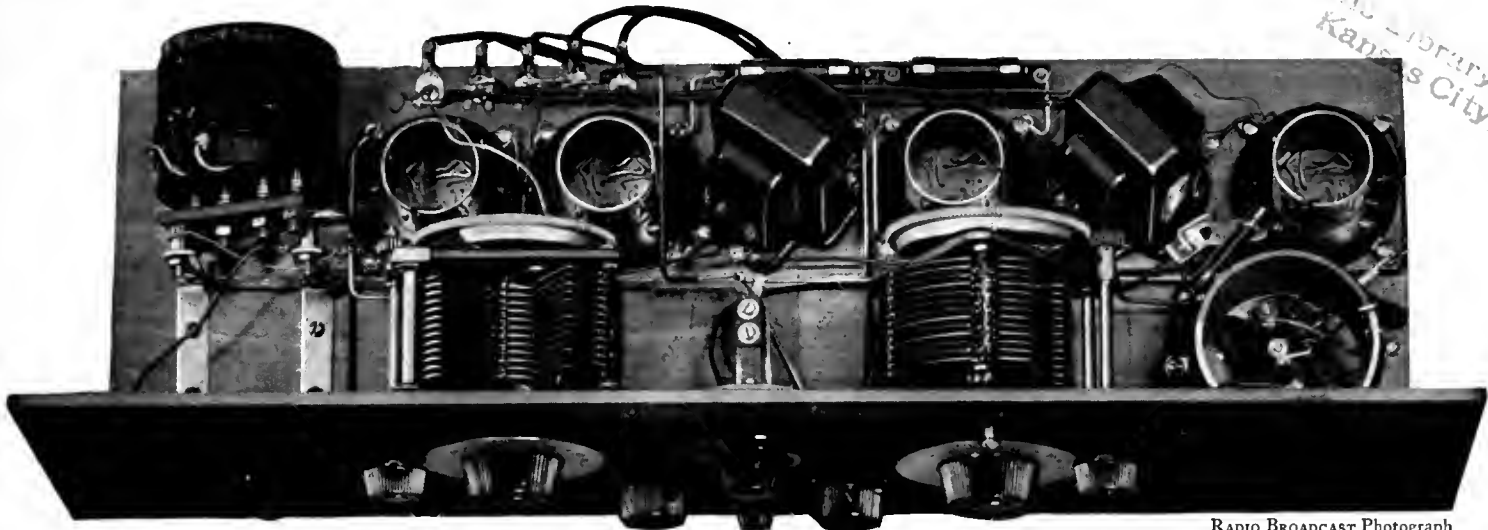

RADIO BROADCAST Photograph

FIG. 6

One of the early models of the Universal which was abandoned because of wiring and electrical feedback difficulties

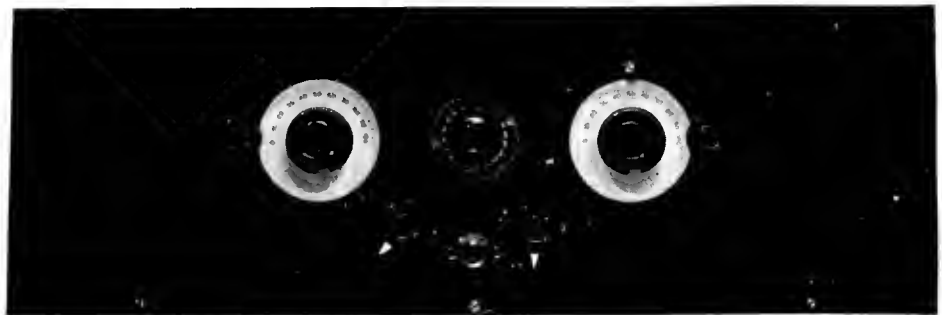

RADIO BROADCAST Photograph

FIG. 7

A very symmetrical panel may be had by bringing the volume control resistor to the center as shown here

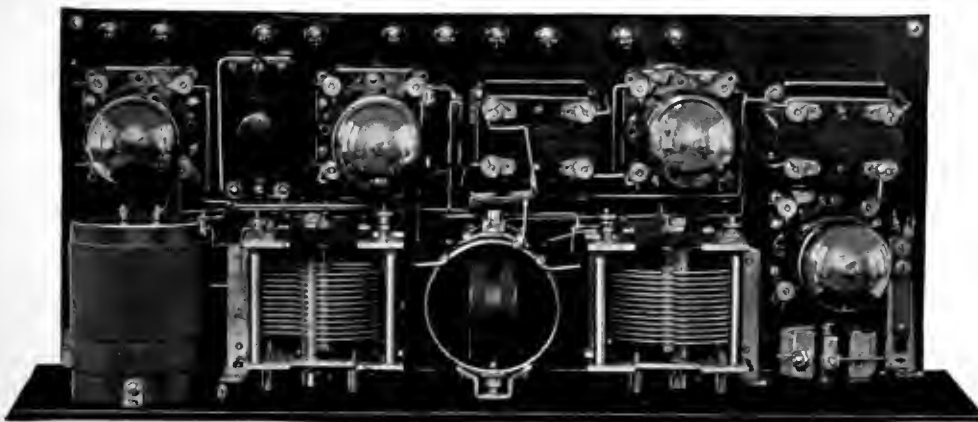

RADIO BROADCAST Photograph

FIG. 9

The circuit used in the Samson receiver is our old stand-by-the stage of neutralized, tuned radio frequency amplification, a regenerative detector and two stages of high quality transformer coupled audio amplification. The neutralizing system is particularly simple to handle and but few improvements in the circuit could be made. Some reduction in plate current consumption may be had by placing a 3 to 4½ negative bias on the first tube and better performance may be had from the audio, without complicating either the building or operation, if the R. F. stage rheostat is confined to that tube and ballasts are used in the filament circuits of the first and second audio tubes. If a 201-A type tube is used in the first stage, a ¼-ampere ballast may be used and where the new 112 type tube is used, a ½-ampere ballast will serve very well. In this last case, raising the plate voltage on the last tube to 135 volts and increasing the grid bias to minus 9 volts will be found worth while

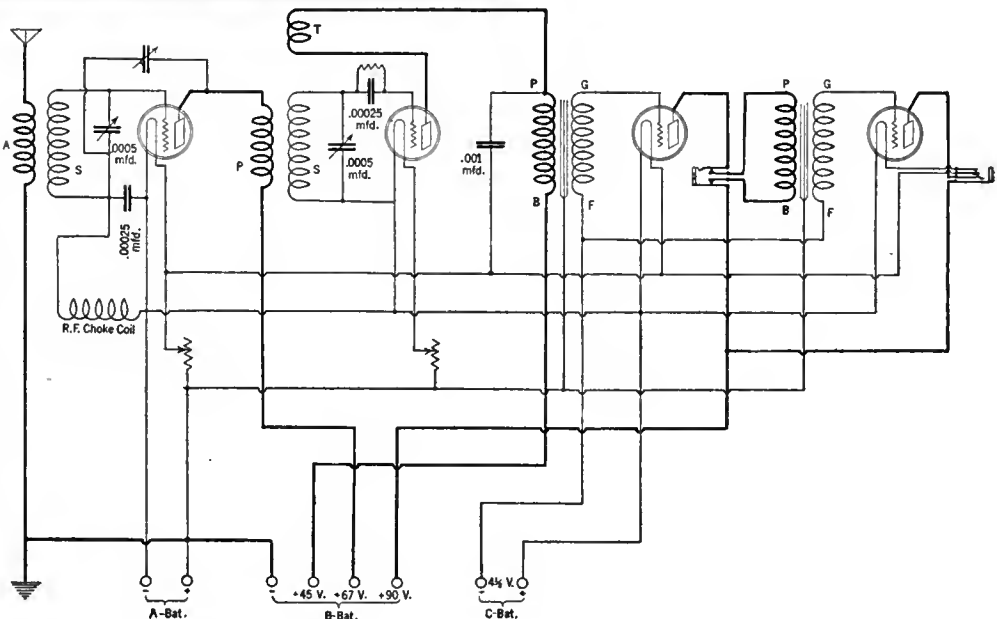

FIG. 8

Looking down on the Sampson T C Receiver. So much equipment in so small a space is in itself an accomplishment. This layout is a little difficult to approximate, but when you have it finished it is a real receiver. The tests run on it in our Laboratory revealed it to be one of the best we have ever had submitted for test. It is compact, easy to handle, economical to use, and the tone quality is far above the average. On the second stage audio it performs very well with a cone speaker which is saying much for a transformer-coupled audio receiver

# "How Long Will My B Batteries Last?"

New Thoughts on an Old Question—How to Choose the Proper Unit for the Proper Use—The Economic Importance and Use of the C Battery



By GEORGE C. FURNESS

Manager, Radio Division, National Carbon Company

THE question "How Long Will My B Battery Last?" was old when radio broadcasting began, and from then until now, the answers have rarely been satisfactory. If the question were asked of a radio battery expert, the answer would consist of a cross-examination of the user as to the kind and size of battery, number of tubes, the B battery voltage, the C-battery bias and so on, world without end, until the inquisitive child appears dumb in comparison. If the question were asked of an unreliable clerk in the radio store, who had become an expert over night and who, knowing little, feared less, the answer would be whatever figure the clerk thought would most please the questioner.

Both types of answers are equally unsatisfactory to the radio user. In the one case, he is not generally interested in a discussion of the many factors which affect the life of his battery, and in the second case, he does not want an incorrect answer.

Although the laws of physics and chemistry continue to operate as formerly, thus bringing in just as many factors as of old in affecting the life of a B battery, conditions have become sufficiently standardized with respect to broadcast receivers so that we can now fix many of what formerly were variable factors. Common practice thus enables us to simplify a complex subject and give results which are in close approximation to actual performance.

This article is written by a student of radio batteries who still finds it impossible entirely to get over the old habit of severe cross-examination and discussion of every factor. We are therefore unable to come to the consideration of battery life under simplified conditions without first explaining the basis on which simplification is accomplished.

Here then are the assumptions on which the simplified story is built:

1. That the battery is of reliable, high grade manufacture.
2. That 90 volts of B battery is used on both radio and audio frequency amplifier tubes.
3. That 45 volts is used on the detector tube.
4. The battery is considered as discharged when each  $22\frac{1}{2}$ -volt section drops to 17 volts. This is the conventional "cut-off" voltage. Experience has shown that many users continue to obtain satisfactory results and do not discard their B batteries until long after they have passed this 17-volt point.
5. That the grid bias on all radio frequency tubes is zero.
6. That the grid bias on the audio amplifier tubes is either zero (no C battery) or is  $4\frac{1}{2}$  volts negative when a C battery is used.

7. That the tubes are burned at normal filament brilliancy.
8. That the receiving sets employ tubes which have the electrical characteristics of the UV-199 or UV-201A.

HOW MUCH IS THE AVERAGE RECEIVER USED?

WHEN a user asks "How long will my B battery last?" he wants to know how long it will be before he will have to buy another battery. He does not want to be told how many hours of operation he will get from his battery because he does not know how much he is going to use his receiver, and therefore he cannot tell how soon he will have to renew his batteries. The other horn of this dilemma is that the life of a B battery, in terms of elapsed time, rises and falls with the extent to which it is used. Therefore, a satisfactory answer forces us to a consideration of the average hours of use of a radio receiver. This is a fertile subject for discussion among radio fans and, in general, one man's opinion has been as good as another's because they have all been opinions rather than facts drawn from extensive investigation. We are fortunate in having available a considerable amount of data which warrants the conclusion that average year-around use is in the close neighborhood of two hours daily. We have, therefore, based all of our battery life figures on a two-hour daily use. Any reader who feels that his use is more or less than two hours per day, should decrease or increase the figures given, accordingly. In those rare instances where the average use exceeds three hours daily, the battery life should be somewhat more than proportionately decreased. Similarly, if the average use is less than one and one-half hours' use daily, the battery life should not be increased in full proportion.

Experience has shown that the drain on



FIG. 1

The cylindrical cells which go to make up two types of B battery. That at the left is for light duty batteries, that at the right for heavy duty batteries. A zinc cylinder encloses a compound in which is located centrally, the carbon rod. The carbon is the positive pole of the battery cell, the zinc can the negative



FIG. 3

This is a heavy duty battery designed for use with receivers where the current drain is 14 milliamperes or over

storage battery tubes at 90 volts and without bias is 6 milliamperes per tube, and when using the proper C battery, this figure is reduced to 2 milliamperes. The drain on this tube when used as a detector is also 2 milliamperes.

The difference between the B battery current drain of dry cell and storage battery tubes is not great enough to warrant separate figures or calculations for dry cell tube sets.

We have been clearing out underbrush all this time, so that we can see one of the two things which we must always know to determine how long a B battery will last that is, the current drain on the battery. This is now merely a matter of arithmetic, knowing the number of tubes and how they are used. For example: here is a three tube set without a C battery. Its drain is twice 6 for the two audio tubes, plus 2 for the detector, a total of 14 milliamperes. A C battery would change the story to twice 2 plus 2, or 6 milliamperes. (We never work out one of these examples of the B battery drain with and without a C battery, that we don't marvel afresh at the saving involved.)

Once we know the current drain of a battery, all that we have to do to determine its life is to put it on test at that drain and see how long it lasts. It doesn't suffice, how-



FIG. 2

Several types of B batteries, varying both in voltage and size. All are for light duty

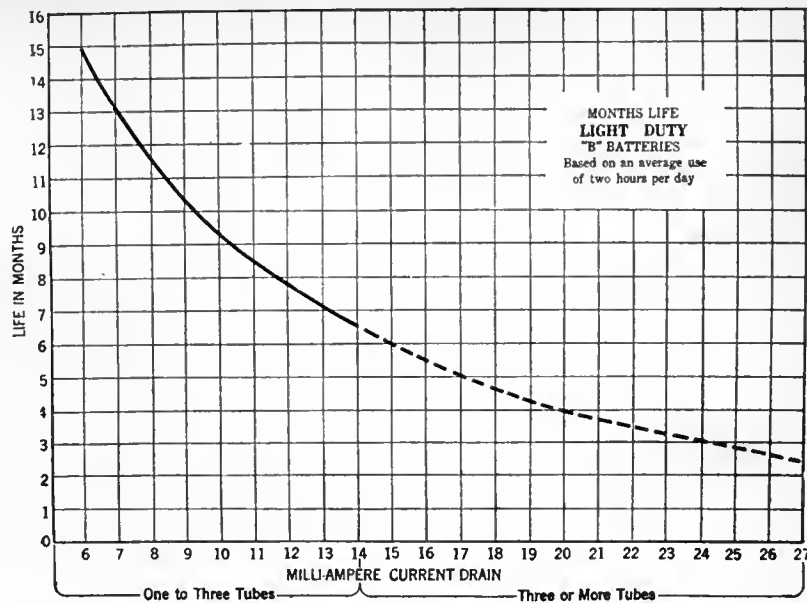

FIG. 4

All the curves shown on these pages are based on the results obtained from a test conducted to determine the average number of hours of use of a receiving set. The unbroken part of the curve indicates the life of a battery when used with a receiver employing one to three tubes where the total milliamperes drain does not exceed 14 milliamperes. Where more tubes are used the drain is greater and the battery correspondingly lasts over a shorter period

ever, to test a battery at one drain and then calculate the life at other drains, for the electrical capacity varies somewhat with the drain. If a battery lasts 1000 hours at one drain, it probably will not last a full 500 hours at twice the drain. Therefore, the only way to determine how long a battery will last at different loads is to test it at those loads. This has been done.

The drains chosen were 4, 8, 16, 24, and 32 milliamperes, which covers the entire range of load ordinarily encountered. Several tests were made for each drain at different periods and each test represents the performance of several batteries.

The entire series of tests were made on two sizes of batteries, designated as the Light Duty and the Heavy Duty. The illustrations in Fig. 1 show the size of the

cells used in the Light Duty and in the Heavy Duty battery. The illustrations in Fig. 2 show the three common forms of the Light Duty battery—the 22½-volt unit which is sometimes referred to as the "5-pound battery" and the vertical and horizontal forms of the 45-volt unit.

The size of the cells in a battery determines its electrical capacity, not the number of cells and the voltage. The 22½-volt and 45-volt units shown in Fig. 2 are all Light Duty batteries, even though one is twice the weight and dimensions of the other.

Fig. 3 shows the Heavy Duty battery which is generally made only in a 45-volt unit.

One of the results of the elaborate series of tests on the two sizes of batteries has been to enable us to determine the field, i.e., the drain, where each is best suited. The answer is this:—Use the Light Duty on all drains below 14 milliamperes and the Heavy Duty on all drains above 14 milliamperes. An approximate rule, in terms of the number of tubes, is:—The Light Duty battery should be used on sets of one to three tubes; the Heavy Duty size on sets of four or more tubes. Let it be noted with all possible emphasis that the rule makes no mention whatever of the smaller size batteries. This is because the Light Duty size is more economical than any of the smaller size batteries *however low the drain*. The justification for the smaller size batteries lies entirely in their portability, never in their economy.

When we tell how to fit the right size battery to a receiver in terms of the milliamperes drain of that receiver there are practically no exceptions, for we are dealing with a fixed electrical unit: the milliamperes; when, however, we talk in terms of number of tubes, a simple unit, under-

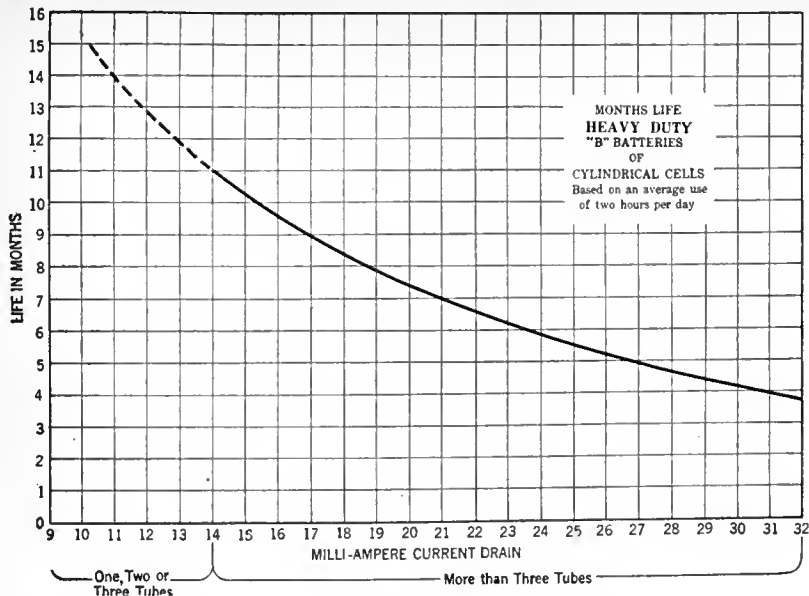

FIG. 5

Where the ordinary heavy duty battery is employed for receivers having more than three tubes, the period of life is greater as can be seen by the above curve, than if light duty batteries were employed

standable to all, we obtain a simple rule, but, like most simple rules, there are exceptions.

"One to three tubes" covers most sets below 14 milliamperes, and "four or more tubes" covers the great majority of sets whose drain is above 14 milliamperes. One exception is that of one model of the Radiola super-heterodyne, which is so designed that, although it employs six tubes, the drain is only 12 to 13 milliamperes. Another exception is the four- and five-tube receivers, recently described in RADIO BROADCAST, which are so constructed that their drain is much less than 14 milliamperes. There are, therefore, certain exceptional cases where the Light Duty battery is the proper size for sets of four or more tubes.

Practically no one uses the Heavy Duty battery when the Light Duty battery should be used. A recent survey has indicated, however, that a large proportion of the radio users are making the rather serious mistake of using the Light Duty when they should be using the Heavy Duty battery. The use of the Heavy Duty battery on sets of four or more tubes is not only much more economical, but also raises still further the high convenience factor of dry cell B batteries.

At last we have come to the point where we can discuss B battery life, for we know now the two essential factors, the current drain, and the correct size of battery to use for that particular drain. The rest is clear sailing.

THE LIGHT DUTY BATTERY ON ONE- TO THREE-TUBE SETS

THE curve in Fig. 4 is derived from the data furnished by the tests on the Light Duty battery. To "work" the curve is easy. Take the three-tube set about which we have already spoken. The drain without a C battery was 14 milli-

amperes. Reference to the curve shows that at this load, the life is 6.4 months.

With the set pulling only 6 milliamperes when a C battery is used, the life is just fifteen months. "Too long," you say. You don't believe it? Very well, we won't quarrel. You and I both know that Niagara Falls is very, very high, but neither cares whether it is actually 250 or 400 feet from top to bottom. Let's say "more than a year" for the life of the battery and let it go at that.

The curve does not show battery life for drains of less than 6 milliamperes because there is little interest in a life of over fifteen months, and also because we do not wish to overtax the reader's credulity.

We have said that the Light Duty bat-

tery should not be used on drains in excess of 14 milliamperes but we have extended the curve in a dotted line up to 27 milliamperes. This makes it possible to determine the life of the Light Duty battery even when wrongfully used on excessive drains.

Another way of expressing the same data given by the curve in Fig. 4 and of avoiding the necessity of even thinking milliamperes, is shown in the following table:

LIFE OF LIGHT DUTY B BATTERY

(Based on average use of two hours per day)

NUMBER OF TUBES	WITHOUT C BATTERY	WITH C BATTERY
1	More than a year	More than a year
2	11 months	More than a year
3	6 months	More than a year

The shortest life in the table is six months, i.e., two renewals a year. The Light Duty story then comes down to this: When properly used, this battery will not require more than two renewals per year for two hours' use per day.

THE HEAVY DUTY BATTERY ON SETS OF FOUR OR MORE TUBES

THE life of the Heavy Duty battery under various drains is shown in Fig. 5. In this case the curve is dotted below 14 milliamperes—the field of lower drains where the Light Duty battery is better suited, as previously discussed.

The life of this battery on a five-tube neutrodyne with a C battery on the audio stages is worked out thus: Two radio frequency stages at 6 milliamperes each is 12; the detector at 2 and each audio stage also at 2—totals 18 milliamperes. The curve shows the life to be 8 months.

A substitute for the curve is given in the following table:

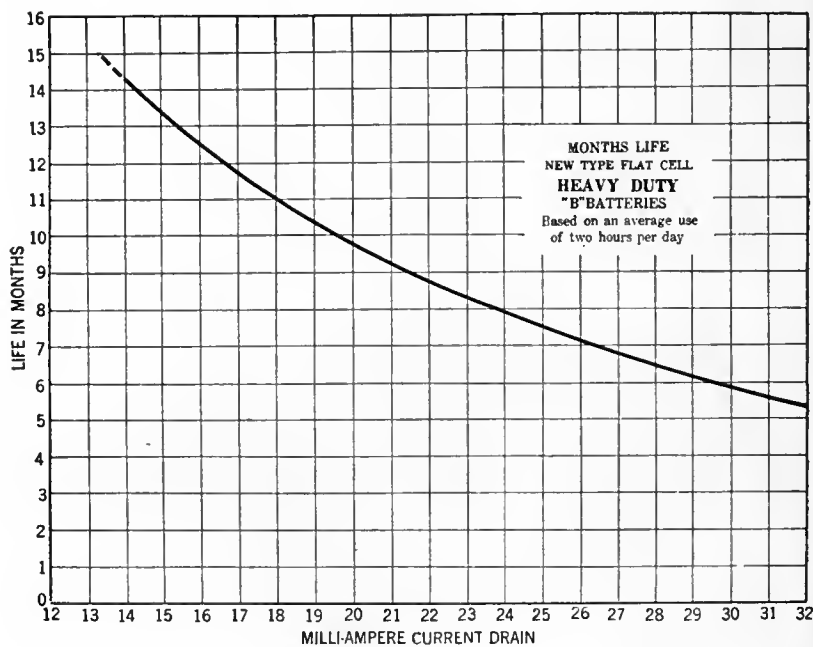

FIG. 6

This curve of a newer type of heavy duty B battery shows conclusively that where high drain is to be experienced and where long life is to be expected, the flat type cell unit approximates, more than the other types, the ideal condition



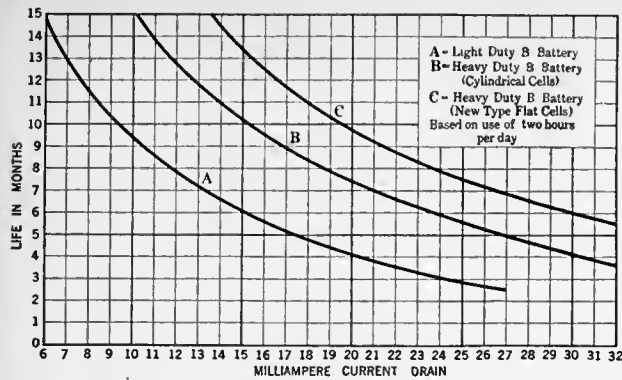

FIG. 7

This composite curve illustration shows very definitely the comparative longevity for three types of batteries, where the current drain is the same in each case

LIFE OF HEAVY DUTY B BATTERY

(Based on average use of two hours per day)

NUMBER OF TUBES	WITHOUT C BATTERY	WITH C BATTERY
4	7	Over a year
5	*6	8 mos.
6		6 mos.

\*This figure is slightly higher than is shown by the curve when using the calculated current drain. Experience has shown, however, that six months' life is generally obtained. This longer life results from operating the receiver at lower drains in order to avoid the distortion which accompanies high volume in the absence of a C battery.

The space for the battery life on a six-tube set without a C battery is left blank for we are not familiar with any six-tube, factory-made set now being produced which does not use a C battery.

Here again it will be noted that the *minimum* life to be expected from the Heavy Duty battery is six months, or two renewals per year, based on 2 hours' use per day.

The new type of dry cell battery, consisting of flat cells piled on each other layer by layer, instead of the conventional cylindrical cells soldered together, is a special case under our discussion of the Heavy Duty size battery. The external dimensions and general characteristics of this new type of battery are the same as those of the Heavy Duty battery. The difference lies in the higher capacity and longer life of the new battery. The flat construction results in the use of more of the active chemical ingredients per unit of volume because it avoids the waste of space between the cells in the cylindrical type of battery.

The curve in Fig. 6 shows the life of this flat cell, Heavy Duty battery at various drains.

POWER TUBES

WE MUST also consider the effect of the new, highly important power tubes, UX-112, UX-120, and others on B battery life. The situation is a bit complicated technically, but is most simple from the standpoint of results, particularly when we confine our attention to those cases where

practically all the power tubes will be used, i.e., in sets of four or more tubes.

The new power tubes must be used with a C battery. Therefore it is necessary to provide C battery connections in order to use either of these tubes in sets which were formerly without a C battery. The net result of the change will be a decrease in B battery life.

The drain of these power tubes when properly biased averages around 5 or 6 milli-amperes. This is 3 or 4 milli-amperes more than that of the biased tube which it replaces. The use of either of these power tubes on a set already equipped with a C battery will therefore increase the total drain about twenty per cent.

In selecting the proper size batteries for multi-tube sets employing either of the new power tubes, one point should be kept in mind. The Heavy Duty size will, of course be chosen to supply the original 90 volts, but the battery which furnishes the "top 45 volts" to supply 135 volts to the power tube should be of the Light Duty, not the Heavy Duty, size. This "top" 45 volt battery carries the 5 or 6 milliampere drain of the power tube only, and will therefore last "more than a year."

Articles on "How to Build a Radio Receiver, How to Erect your Antenna," in fact all the "How to" articles on radio generally have a paragraph near the end on "How to look for trouble," as though it were necessary to search for it. But the

precedent is too strong to break. We shall therefore include the customary paragraph of warning and advice.

The figures on the B battery life are based on proper radio equipment and normal operating conditions. They will *not* apply under such conditions as:

- (1) Leaving the set turned on for a week and then forgetting that you did so.
- (2) Use of tubes which have an abnormally high B battery drain (an occasional misfortune.)
- (3) A faulty by-pass condenser or any form of short circuit which continuously drains the B battery.
- (4) Chronic over-burning of the filaments.
- (5) When using old exhausted tubes which need renewing or re-activating.
- (6) Failure to renew an exhausted C battery.
- (7) Leaving the shears resting on the battery terminals over night.

The next time any one asks us how long his B battery will last we shall not ask a single question, but immediately reply, "Six months at least, generally eight months and often a year or more." Then if the combination of a New England conscience and an engineering training gets in its deadly work, we will be forced to add "Of course you understand that this answer is based on your using batteries of proper size and of a reliable make and also on an average use of your receiver of two hours per day."

We might also go on to explain that there would be occasional, rare cases where the battery life would be only four or five months but that for every such case there would be literally thousands of instances, even with multi-tube sets, where the battery life would be in the nine- to twelve-month range.

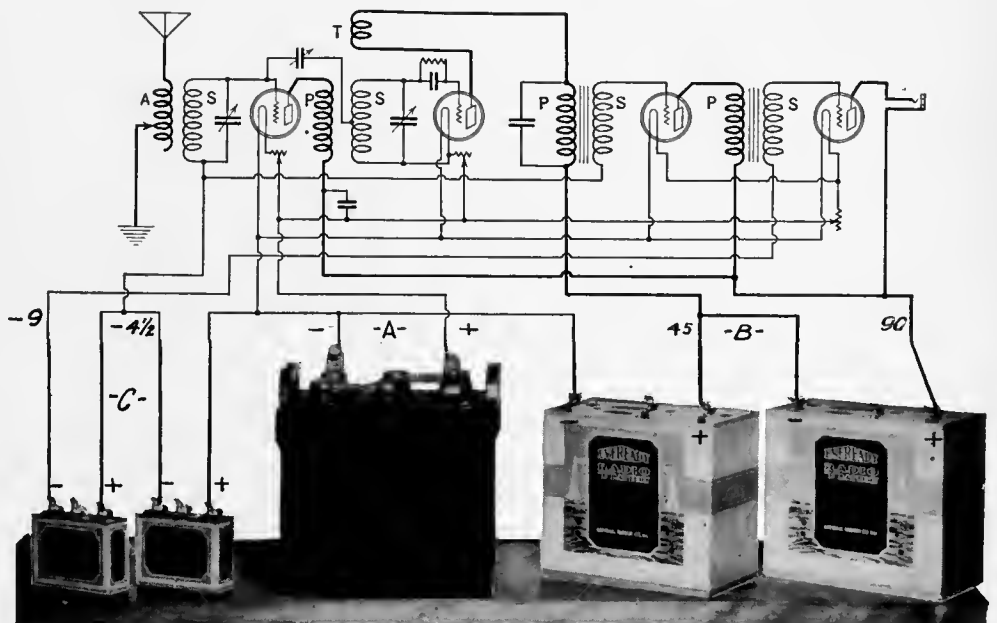

FIG. 8

It is usual in depicting the circuit diagram of the Browning-Drake receiver described in the December, 1924, issue of Radio Broadcast, to represent the batteries employed, symbolically. Here is the diagram showing actual illustrations of batteries connected in the circuit. The reader, however, will do well to become accustomed to the symbolical representation of batteries and other parts of radio circuits

# How to Use Vacuum Tubes

A Clear Explanation of How and Why Tubes are Rated as to Amplification Constant, Mutual Conductance, Plate Impedance, Etc.—How to Make and Use a “Characteristic Curve”—Answers and Explanations for the Most Commonly Asked Questions About the Use of Receiving Tubes

By KEITH HENNEY

Director, Radio Broadcast Laboratory

OF ALL the various instruments that go to make a radio receiver, there are none that approach the vacuum tube in importance. In the majority of receivers to-day the tube is the most essential accessory, and upon its proper operation depend all of the qualities of which the owner of the receiver brags. The sensitivity of the receiver, the volume and quality of reproduction, the economy of operation, all rest upon the tubes that are used and the manner in which they are operated.

Therefore, it behooves the owner or builder of a radio receiver to become as well acquainted as possible with the various functions which his tubes perform, and to know what happens when he does this or that to those small bits of glass and metal.

In the December RADIO BROADCAST, the use of new semi-power tubes was discussed and the connection between undistorted audio output and the operating conditions of tubes was outlined. Data on the amount of power necessary to operate a loud speaker properly and the power obtainable from various tubes were given. It was pointed out that the purchase of high quality audio transformers, or cone type loud speakers was futile unless one used a tube with an output of about .06 watts to operate the loud speaker; that sufficient power was not obtainable from a single dry-cell tube to operate a cone type speaker without distortion; and that the “scratching” in cone speakers was due, in the vast majority of cases, not to the speaker but to the amplifier which was overloaded.

In this article some of the other important

THIS is a most unusual article in many ways. For one thing, it contains the most up-to-date presentation of information on the use of commercially available vacuum tubes which has so far been presented. The curves and tables in this article are the result of tests on more than 250 tubes and show the amount of work which has gone on recently in the Laboratory. The data given here shows, for example, what C battery potential to use with a given B battery voltage, and what the effect of varying either or both is. The curves show also, the proper filament potential which should be applied to many types of tubes for greatest efficiency. All in all, this is in reality a semi-technical guide book to radio tubeland. The first article in this group appeared in this magazine for December, and another will be published in an early number which will conclude this series, prepared by Mr. Henney, director of the RADIO BROADCAST Laboratory.—THE EDITOR

aspects of vacuum tube operation will be discussed, and an attempt will be made to clear up some misunderstanding with regard to what is generally considered as complex tube terminology.

For example, nearly everyone will say that a tube should have a high value of mutual conductance. But what does nearly everybody understand by this high sounding phrase? And what is a characteristic curve, how is it made, and after one has it, of what use is it? What of amplification constant, “high mu,” plate impedance, etc. What do these terms mean?

It must be understood, first of all, that a tube is a complex creation, that its actions are always controlled by certain boundary conditions which surround it, and that everything that it does is a product of not only one external cause, but of several. It will be possible to treat of but few of the important aspects of vacuum tube theory and practice in this article, or to more than scratch the surface of those few. Readers are referred to Professor Morecroft's excellent book, *Principles of Radio Communication*, which has nearly half of its 1000 pages devoted to vacuum tubes, and to the standard 385-page text of Van der Bijl, *Thermionic Vacuum Tubes*.

## SOME FACTS ABOUT THE FILAMENT

A TUBE consists of a glass container into which are sealed three metallic elements, after which the air and gas sealed into the tube are pumped out. The most important of these elements is the filament. It is the thing that lights up when the A battery is placed across its ends; and which blows up when the B battery is accidentally connected to the terminals. When the filament is dead the tube might as well be buried. And when the filament wire is poor, the tube is poor. And that's that.

In general there are three types of filament now being sealed into glass containers for radio use, the tungsten filament, the thoriated filament and the oxide filament. The tungsten is represented in the detector tube, UV-200, thoriated filaments are in the newer types, the 201-A, the 199, the 120, and similar tubes, and oxide filaments are used in Western Electric tubes as well as the WD-12, and the UX-112.

The pure tungsten filament and the oxide coated filaments are the oldest of the present types. Pure tungsten must be heated to a much higher temperature than either the thoriated or the oxide filament before it emits sufficient electrons for ordinary operation. In other words it is not so efficient, for more electrical “filament power” must be expended to get a given number of electrons. The data in Table 1 represents the filament efficiency of several tubes under average operating conditions and shows the plate current in milliamperes per watt expended in heating the filament.

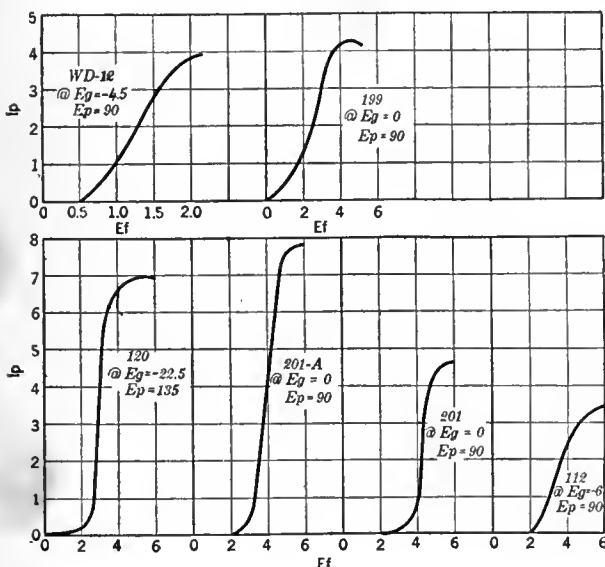

FIG. 1

These curves show the relation between the filament voltage and the plate current, giving plain evidence that it is useless to run filaments above their rated voltage. Attention is called to the plate and grid voltage conditions under which these curves were made

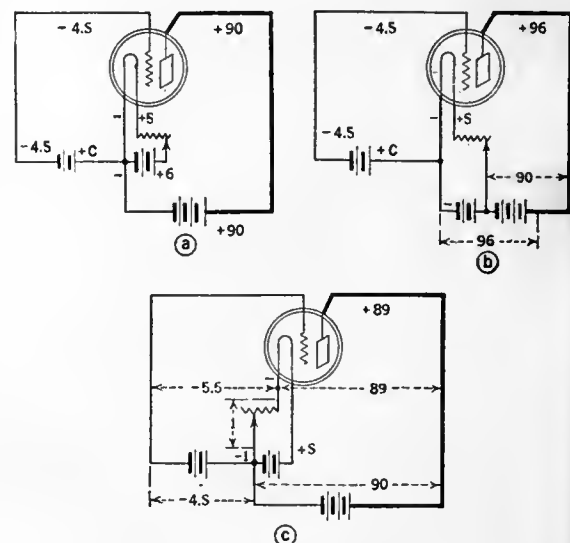

FIG. 2

Many questions are asked the Grid department of this magazine concerning the proper method of connecting A, B, and C batteries together. These diagrams give three possible connections, giving in each case the resultant filament, grid, and plate voltages. It has become standard practice to connect negative A, negative B, and positive C together

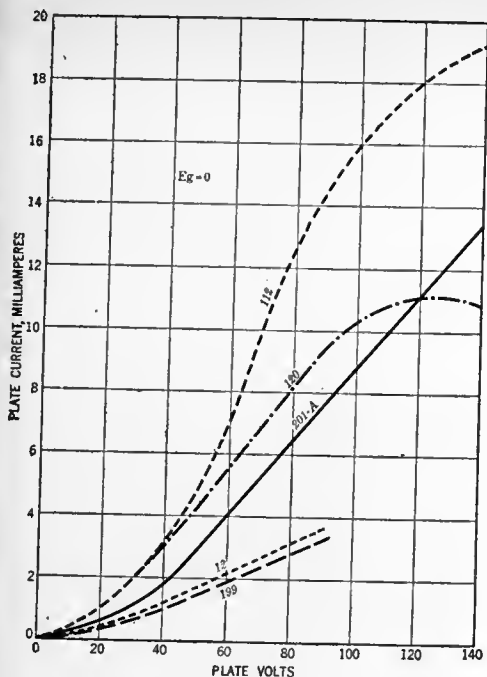

FIG. 3

The effect of increasing the plate voltage on various standard tubes is shown in this Figure. Data for these curves was made at rated filament voltage and at zero grid voltage.

Oxide filaments are made by a complicated process of baking on to the surface of a platinum, or other metallic wire the oxides of strontium, barium, and calcium, which emit electrons at a low temperature. In Europe such tubes are known as "dull emitters" since they are operated at a dull red heat and never as bright as the tungsten or the thoriated wire. Thoriated filaments are the result of a fortunate accident in the laboratories of the General Electric Company. A certain run of tubes was found to be very efficient, much more so than usual. It was found that the filament wire had come from a container in which thorium had been treated. The tungsten had combined with some of the thorium which like the oxides of the elements mentioned above emits electrons at a low temperature.

The result of this important discovery, that thorium mixed with the filament wire would increase the filament efficiency, was the production of the tubes with which everyone is now familiar. Instead of a tube filament that needed one ampere at 5 volts to get the proper number of electrons, present day tubes require but one fourth of this current. Four of the thorium tubes can be run at the same expense as one of the old ones. It may be interesting to those who still use the soft detector tube, UV-200, to know that it requires more current than three of the 201-A type.

The charts in Fig. 1 show the plate current in milliamperes of several important tubes for various filament voltages. They show the futility of burning tubes beyond their rated voltage, for above that point there is slight increase in plate current. Furthermore, pushing up

the filament voltage is one of the most certain methods of decreasing the life of the tube. For this reason a filament voltmeter is an important and economic addition to any existing receiver.

THE PART PLAYED BY THE GRID AND PLATE

THE other elements in the orthodox tube play important parts in the operation of this remarkable device. The plate has been mentioned already. It is maintained at a positive voltage with respect to one end of the filament by means of the B battery. The electrons coming from the heated filament are attracted toward the plate, because they are negative quantities of electricity. Each electron that arrives at the plate represents a certain flow of electric current, and the sum total of this electronic flow makes up the plate current. The plate battery supplies the energy for this transfer of electrons as shown in Fig. 2.

The number of electrons that flow to the plate depends upon at least two factors, the filament temperature, and the plate voltage. Under ordinary conditions the filament is heated to the point where further increase in temperature has no effect on the plate current. In other words the tube is operated under the condition of "filament saturation."

Under this condition the plate current is a function of the plate voltage, and Fig. 3 shows the effect of varying the B battery voltage while a constant A voltage is applied to the filament and a constant voltage is on the grid.

The grid is a mesh of wires placed between the filament and the plate. It, too, has control over the flow of electrons toward the plate for when negative it repels the negative electrons; when it is positive it draws more electrons out

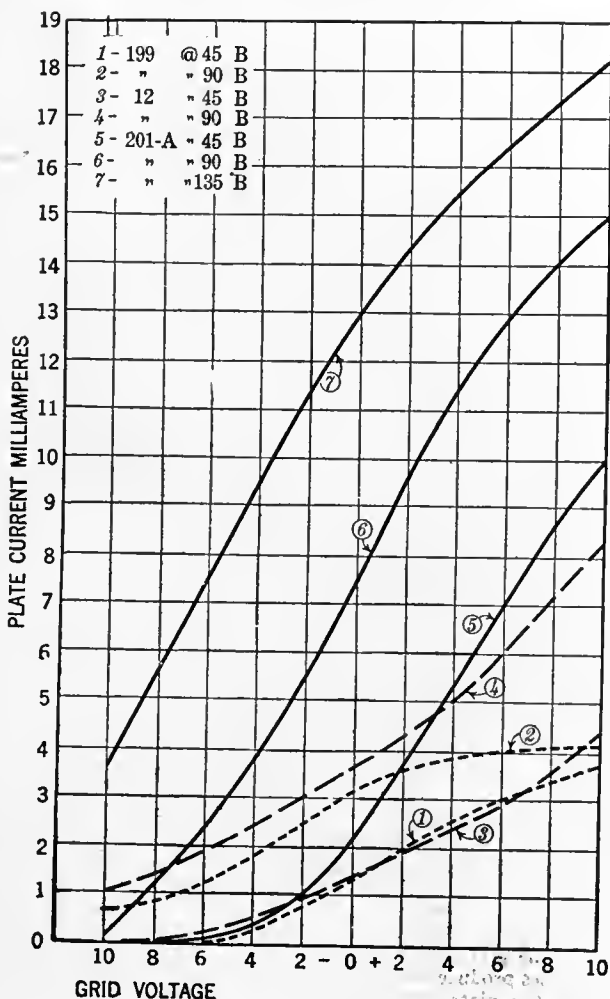

FIG. 4A

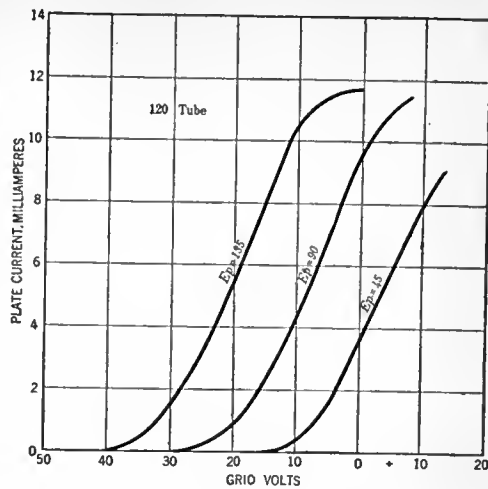

FIG. 4B

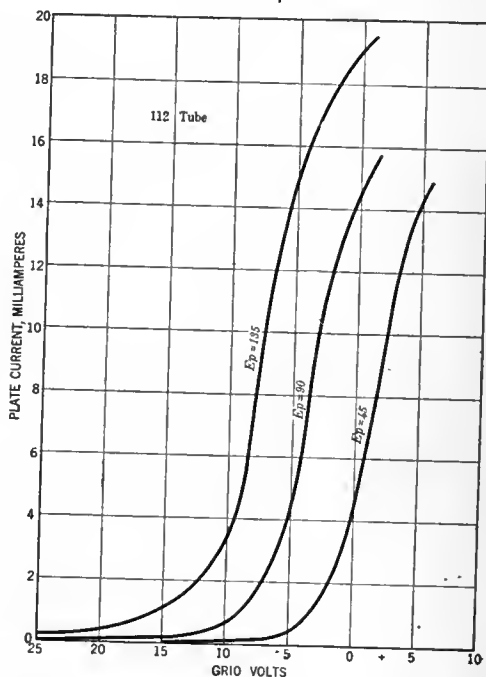

FIG. 4C

Characteristic curves, plate current vs. grid voltage, are shown here. Increasing the plate voltage on amplifier tubes makes it possible to use much greater C voltages, with the result that greater input voltage may be used without distortion due to "overloading." The lower curve of the 201-A tube at 45 plate volts is an indication of an excellent detector. The long straight portions of the 201-A curves are the parts that are useful for amplification

into the space between the elements, and the plate current increases—provided the filament temperature is up to the required point.

It is a matter of great importance that the voltage of the grid has more effect on controlling the plate current than has the plate voltage. It is for this reason that the tube amplifies, and carries out its other multitudinous functions. If the grid has ten times the effect that the plate voltage has upon the plate current the amplification factor of the tube is said to be ten, and so on.

The manner in which the grid controls the plate current may be seen in Fig. 4A which is a "characteristic curve" of an average 5-volt receiving tube of the 201-A type. There are several curves on this plot, each one representing the effect of the grid voltage and each taken at a different value of plate voltage.

There are, then, three factors which control the plate current of a vacuum tube, the filament voltage, the plate voltage and the grid voltage.

TUBE	MILS PLATE CURRENT	FIL. WATTS	MILS PER WATT	MILS PER WATT PER DOLLAR
199	3.2	.18	17.8	7.10
201	7.6	5.00	1.52	( )
201-A	7.6	1.25	6.1	2.44
120	7.0	.375	18.7	7.45
112	14.4	2.5	5.75	.89
12	3.6	.275	13.10	5.24

As stated before, tubes are usually operated under the condition of filament saturation, that is, the conditions are stable with regard to the filament voltage. This leaves only two factors which control the plate current, and since a tube is usually operated with a fixed value of plate voltage, it is only the fluctuating grid voltage that varies the plate current.

WHAT CHARACTERISTIC CURVES MEAN

NOW let us see how these characteristic curves are made, and what they mean. Suppose that in our home laboratory we have a double range voltmeter, such as the one made by Weston Electric Instrument Company, or the Jewell Model 55, or Hoyt type 17. Such a meter will read from zero to about 10 volts and from zero to about 100 volts. Thus it will measure the voltage across the filament and on

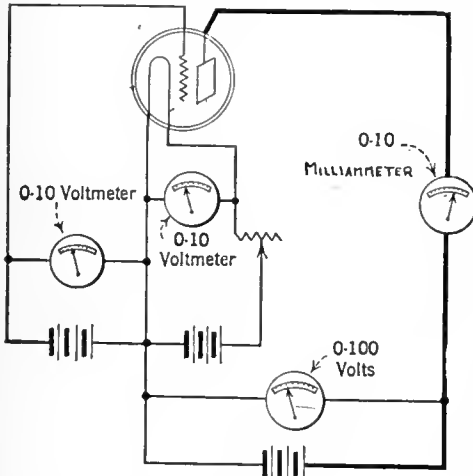

FIG. 5

A simple arrangement of apparatus by means of which characteristic curves of Fig. 4 may be taken. With proper switches, two meters will suffice for this experiment, a milliammeter and a double-range voltmeter

the plate or grid of an average tube. Let us connect it first across the filament of a 201-A type tube, regulate the rheostat, as shown in Fig. 5 until we have the required 5 volts on the filament. Then the meter should be placed across the B battery. Now we know that the tube is operating under the proper conditions and all we need to make a characteristic curve is a plate ammeter such as a zero to 5 or 10 milliammeter, Weston or Jewell, which is placed in the circuit between the plate of the tube and the plate battery as shown in Fig. 5. A potentiometer placed across a C battery will give us variations in grid voltage which may be measured as in Fig. 5 and placed on the grid of the tube. As a matter of rough measurement, the potentiometer is not necessary, and indeed our C battery will last considerably longer if the potentiometer is not used.

The low range part of the voltmeter is now placed across the grid and filament to show what voltage is being placed on the grid. The grid voltage is then varied and each change in plate current noted as shown in the data for Fig. 4A. It will be found that for large negative values of grid voltage the plate current will be small, and that for less negative grid voltage the current increases. This is one reason why a C battery on a modern five-tube receiver is quite essential. It reduces the plate current of a single tube from about 7 milliamperes to about 3. After zero grid volts is reached, the C battery must be reversed in order that positive voltages may be supplied. Care must be taken in this process, or the milliammeter will be injured, since a positive grid permits a large plate current to flow.

For this reason a tuned radio frequency receiver which uses a potentiometer to stabilize the radio-frequency amplifier is an expensive proposition. In order to keep the amplifiers from oscillating, the grids must be kept positive by a certain amount. This means that two amplifier tubes will draw considerable current from the B battery

Now that we have collected this data on the relation between grid voltage and plate current,

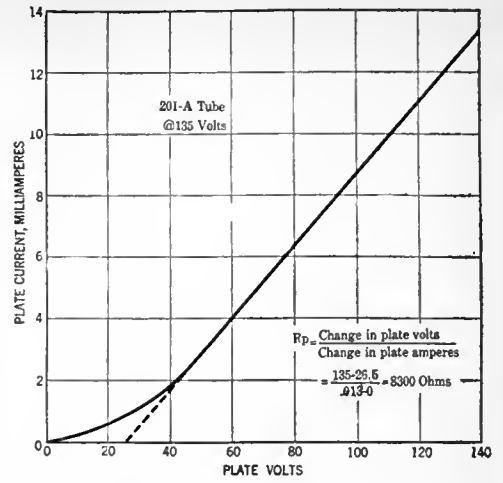

FIG. 7

A method of obtaining the plate impedance of a tube. Only the straight part of the curve is to be used, and the proper values of plate current and plate voltage may be obtained from the curve. To simplify the calculation, the straight part of the curve is prolonged to the zero current line. In mathematical language, the plate impedance is the slope of the plate current-plate voltage line

TABLE 2. 201-A TYPE TUBES

TUBE	NO. TESTED	PLATE CURRENT	AMP. CNST.	PLATE IMPEDANCE	MUTUAL CONDUCTANCE
Arion	4	1.9	9.2	14,400	638
Kismet	3	2.60	7.75	13,250	590
Ureco	8	2.62	8.15	12,300	660
Gold Seal	6	2.43	8.13	13,000	630
Duoiron	9	1.83	10.00	16,000	615
Van Horne	12	2.64	8.63	12,800	677
Sylfan	6	3.00	6.90	12,800	542
Sylvania	6	2.63	8.29	11,350	735
Sturdy	2	2.90	8.20	12,500	678
Magnatron	6	2.75	8.00	12,250	652
Goode	3	2.50	7.90	12,000	658
Empire-Tron	2	1.80	9.50	16,500	581
CeCo	9	2.2	8.48	14,300	592
R. C. A.	6	3.40	7.53	10,100	745
Marathon	2	2.60	8.20	11,500	712
Supertron	3	2.00	9.50	14,600	680
Sea Gull	12	3.60	6.70	10,600	640
Boehm	4	3.62	7.10	9,740	734
Speed	5	3.82	7.35	9,950	734
Ken Rad	5	2.78	8.24	12,400	677
Cleartron	6	4.2	6.75	9,450	715
Perryman	6	3.98	6.53	9,750	670
AVERAGE	125	2.59	8.2	12,700	660

CONDITIONS

FILAMENT VOLTS	GRID VOLTS	PLATE VOLTS
5	-4.5	90

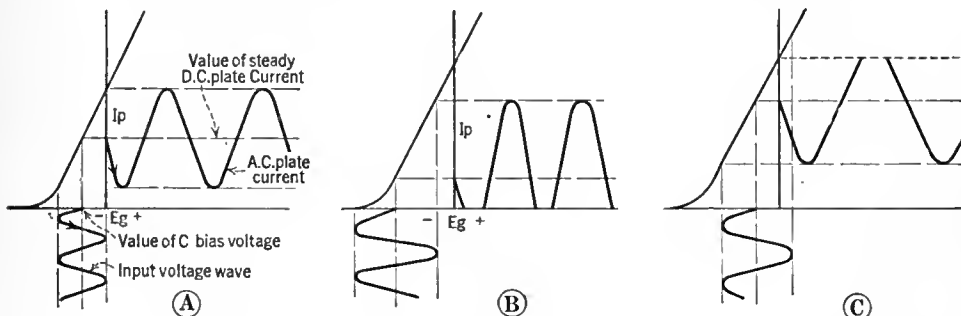

FIG. 6

Three curves showing the effect of proper and improper C bias are shown in this illustration. It will be noted that when the grid goes negative, the plate current decreases. In (a) the correct C voltage is used so that the plate current is a perfect reproduction of the incoming wave. When the C bias is too negative, the lower parts of the plate current curve are cut off. In other words the plate current is actually brought to zero at times. On the other hand in (c) when there is not enough C battery used, the grid goes positive at times, and the tops of the curves are cut off. Both of these latter cases produce distortion of the worst type, most easily detected by watching a milliammeter in the plate circuit. If the needle jumps about, one of the two latter cases is in effect

we may try another value of B battery and repeat the experiment. In this manner data for the three curves shown in Fig. 4A, B and C were taken. The only thing that remains is to plot the data in a curve which gives a complete picture of what happens to the plate current under variations of the grid and plate voltages. They are called "static" characteristics because they were made under static conditions, that is not under the exact operating conditions, for in actual practice there is a load of some kind, in the plate circuit, such as a pair of receivers, a transformer primary, or a large resistance, whose characteristic, when alternating voltages are applied, differs from its direct current characteristic.

Now to see what these curves tell us, let us look at them rather closely. It will be seen that increasing the plate voltage increases the plate current. For instance let us look at the curves in Fig. 4A at the exact center of the picture at zero grid volts. With 45 volts on the plate, the

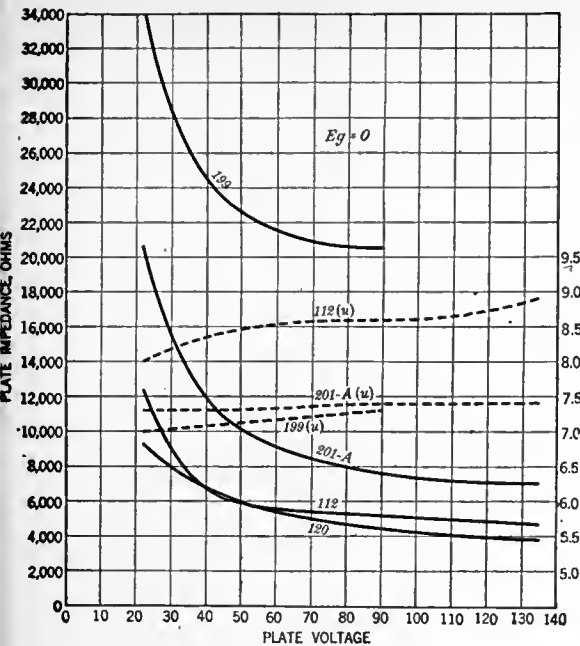

FIG. 8

The three important tube factors, plate impedance, amplification constant, and mutual conductance all vary with plate voltage and with grid voltage. This curve shows how these factors vary with plate voltage

plate current of the 201-A is 2.2, with 90 volts, the current is 7.6, and with 135 the current is 13. Also it will be noted that increasing the grid voltage increases the plate current. For example let us take the 90-volt curve. At negative 2 grid volts, the plate current is 5.6 milliamperes and at positive 2 the plate current is 9.7. It will be seen at once that the grid voltage has greater effect than has the plate voltage. The ratio of these effects is known as the amplification constant of the tube. For example it

will be found from this data that it requires only 5.5 volts change in grid potential to produce the same change in plate current that 45 plate volts change produced. In other words the amplification factor is  $\frac{4.5}{5.5}$  or 8.2.

This may be stated as follows:

Amplification factor =  $\frac{\text{change in plate volts}}{\text{change in grid volts}}$  to produce the same change in plate current.

PROPER USE OF THE C BATTERY

UNDER actual operating conditions, the plate is maintained at some definite value, say 90 volts, and the grid is biased negative by a definite value, say  $4\frac{1}{2}$  volts. The incoming signals which are impressed on the grid are alternating in value, and they cause the actual voltage on the grid to vary from  $4\frac{1}{2}$  as a mean value. For instance, let us suppose that the tube is the second audio amplifier tube and that fluctuating voltages of a maximum, or peak, value of one volt are coming from the previous audio stage. When the impressed alternating voltage is positive the actual negative grid voltage is  $4\frac{1}{2}$  minus 1 volt or  $3\frac{1}{2}$  and when this a.c. voltage is negative, the negative bias on the grid has been increased to  $5\frac{1}{2}$  volts. In other words the voltage actually on the grid varies from  $3\frac{1}{2}$  to  $5\frac{1}{2}$  volts.

We may see how the plate current varies with these changes in grid voltage by noting the proper values from the characteristic curve. Fig. 6 gives a picture of the process showing that small changes in grid voltage produce large changes in plate current.

Now for distortionless amplification, only the straight part of the curve may be used, and the grid must never be permitted to become positive. This limits the input grid voltages to certain definite values. The characteristic curves shown above indicate the proper value of C battery that is to be applied to an amplifier tube with a given value of B voltage. For example it will be seen that if the grid of the tube shown in Fig. 4A at 90 volts B battery goes negative by 4 volts it will be approaching the lower bend in the curve while if it goes beyond  $4\frac{1}{2}$  volts positive, the grid will actually be positive with respect to the filament and distortion is inevitable.

To find from the curve the proper C voltage it is only necessary to measure the length of the straight part of the curve. For example at 90 volts the length in volts is about 9 volts. Then the C bias is about half this or  $4\frac{1}{2}$ . At 135 volts B, about 9 volts C battery may be used.

In an article by Mr. George Crom in RADIO BROADCAST for October the effect of improper C and B batteries was discussed. A consideration of the characteristic curves shows what actually happens when incorrect values are used. For example, when the grid is forced too negative by input voltages, the curved part of the characteristic will be used with the result that harmonics are added to the original sounds coming from the broadcasting microphone. If

TUBE	NO. TESTED	PLATE CURRENT	AMP. CONST.	PLATE IMPEDANCE	MUTUAL COND.
Arion	5	2.00	6.8	19,650	346
CeCo	3	2.33	6.1	16,900	361
Jove	6	1.87	6.0	22,800	268
Gold Seal	3	1.50	6.3	35,400	207
Sylvania	6	1.87	6.0	19,600	305
Perryman	2	1.80	6.35	21,475	296
Van Horne	5	2.66	7.35	24,500	305
Magnatron	6	2.60	6.5	18,500	350
Empire-Tron	2	1.70	7.1	23,400	303
Speed	3	2.2	6.0	19,500	310
Ken Rad	5	2.0	6.76	22,800	300
R. C. A.	5	2.5	6.3	18,600	332
TOTAL	51	2.00	6.5	22,400	304

CONDITIONS

FILAMENT VOLTS	GRID VOLTS	PLATE VOLTS
3	-4.5	90

still greater negative values are impressed on the grid, or if the grid is biased too negatively, the lower parts of the waves will be cut off as shown in Fig. 6 resulting in still greater distortion. As mentioned in Mr. Crom's article, a milliammeter in the plate circuit of such a tube will show an upward deflection under such conditions. The remedy lies in increasing the plate voltage to the values he specified.

Fig. 6 also shows the effect of too little C battery. In this case a strong signal will force the grid positive at times which again results in distortion, though of a slightly different nature. In this case the plate current will decrease as Mr. Crom pointed out. Increasing the C battery negative potential will eliminate this difficulty.

An amplifier that is working properly, with correct B and C batteries will turn out a distortionless output—as far as the tubes are concerned—only when a milliammeter in the plate circuit remains steady. This is the best method of investigating the conditions under which an amplifier works. In a great many cases the C battery value is much too low to take care of loud signals. Increasing the C battery, however, without making corresponding changes in the B voltage is fatal, as Fig. 6 indicates.

Fig. 4 shows the effect of increasing the B battery voltage. The straight part of the characteristic is much longer, a fact that has important consequences. Greater values of C bias may be used, greater input voltages may be applied without distortion, and the tube will have a lower plate impedance. This latter fact is explained later in the present article, and the value of a low plate impedance was mentioned in the article on tubes in the December RADIO BROADCAST.

The curves in Fig. 4, known as the static characteristics of the tubes in question, reveal many interesting facts. For instance the method of calculating the amplification factor

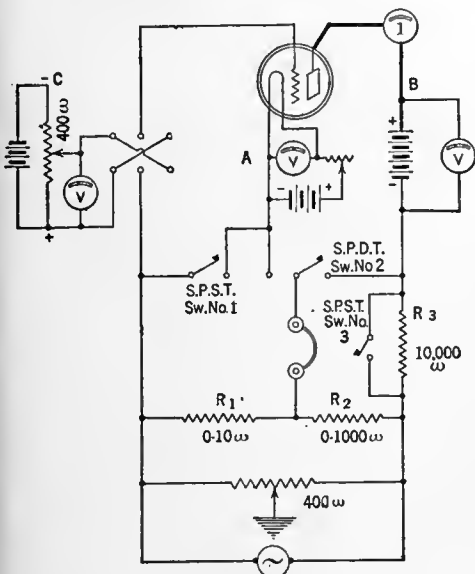

FIG. 9

A diagram of the bridge used in RADIO BROADCAST Laboratory for determining tube characteristics. The resistances R1 and R2 may be a simple slide wire bridge or they may be decade resistance boxes. To measure amplification constant, open switch No. 1, throw No. 2 to the left, close No. 3. Then when silence is obtained in the phones,  $\mu = R_2/R_1$ . To measure plate impedance, close No. 1, throw No. 2 to the right, open No. 3. Then  $R_p = \frac{R_1 \times 10,000}{R_2}$ . The potentiometer across the input with the variable arm grounded is useful in obtaining a balance

TUBE	PLATE CURRENT	AMPLIFICATION CONST.	PLATE IMPEDANCE	MUTUAL COND.	POWER OUTPUT
Daven Mu-6	8.7	6.35	5,350	1,190	.076
Cleartron	6.0	6.35	5,340	1,190	.076
CeCo	5.8	7.0	6,700	1,050	.060
Ureco	8.0	6.8	5,570	1,235	.084
UX-112	5.8	7.9	6,000	1,315	.105
216-A	7.4	6.0	6,000	1,000	.060
Van Horne	4.7	8.65	8,050	1,075	.0936

CONDITIONS

FILAMENT VOLTS AS RATED	GRID VOLTS	PLATE VOLTS
	-9	135

of the tube has been mentioned. It is only necessary to measure along the zero grid line the number of milliamperes change in plate current produced by varying the plate voltage from 45 to 90, and to take any of the three curves and find out how many grid volts change are required to produce the same change in plate current.

THE MEANING OF "PLATE IMPEDANCE" AND "MUTUAL CONDUCTANCE"

NOW there are two other important tube factors, known as the plate impedance, and the mutual conductance. The plate impedance is defined as the change in plate current a given change in plate voltage produces. This may be expressed as below

$$\text{Plate impedance} = \frac{\text{plate voltage change}}{\text{plate current change}}$$

and using the values ascertained for calculating the amplification constant, the plate impedance of the tube under question is

$$\frac{90 - 45}{.0076 - .0022} = 8330 \text{ ohms}$$

This value may be obtained directly from the plate current—plate voltage curve, Fig. 3. Fig. 7 shows how this may be done. This second method is more accurate, since the plate impedance varies with each change in plate or grid voltage. For that reason it should be calculated for small changes and only over the straight part of the characteristic.

The mutual conductance of the tube is an important factor, since it is an expression for the value of the grid voltage in controlling the plate current. It is defined as

$$\text{mutual conductance} = \frac{\text{change in plate current}}{\text{change in grid volts}}$$

For example from Fig. 4A we see that a change of ten volts on the grid, from plus 6 to minus 4 of the 135-volt 201-A curve produced a change of 6.9 milliamperes. Therefore

$$\text{mutual conductance} = \frac{.0069 \text{ amperes}}{10} = .00069 \text{ mhos.}$$

or expressed in the usual units of micromhos the mutual conductance of the tube under question is 690.

This may also be obtained from the interesting relation between amplification constant and plate impedance,

$$\text{mutual conductance} = \frac{\text{amplification constant, or } G_m}{\text{plate impedance}} \text{ or } G_m = \frac{\mu}{R_p}$$

showing that the best tube is one with a high amplification constant and a low plate impedance—but in popular language "try and find one."

All three of the tube factors,  $\mu$ ,  $R_p$ , and  $G_m$  vary with grid voltage and plate voltage as the curves in Fig. 8 show. For purposes of power amplification a low plate impedance is of importance, and the effect of increasing the plate voltage to produce this lowered impedance is clearly indicated. For voltage amplification, a high amplification constant is important.

The effect of tube impedance on the characteristics of an audio-frequency amplifier was shown in Curve 2 in the article by Kendall Clough in the January RADIO BROADCAST.

Anyone can verify the improvement in signal quality with the use of low plate impedance tubes by noting the difference when substituting a high impedance tube, say a 199, or a tube designed for resistance-coupled amplifiers for the final tube in a transformer-coupled set. The low notes of the viols and horns will be lost in the latter case but will suddenly reappear when the low impedance tubes are again replaced. Characteristics of these tubes were discussed in the December RADIO BROADCAST, page 163, and were found to be an extremely important advance from the standpoint of quality.

The methods outlined above for obtaining the important tube characteristics required only two meters, a milliammeter and a double range voltmeter. The method is not so accurate as that employed in well equipped laboratories, but is sufficient for all practical purposes provided small changes of plate and grid voltage are used.

In the RADIO BROADCAST Laboratory a special bridge is used which places an a.c. voltage on the grid and measures the factors of the tube under conditions that are closer to actual operating conditions. A diagram of connections is given in Fig. 9 and by the proper use of switches, only two meters are necessary. The source of a.c. tone may be obtained from a buzzer or from a

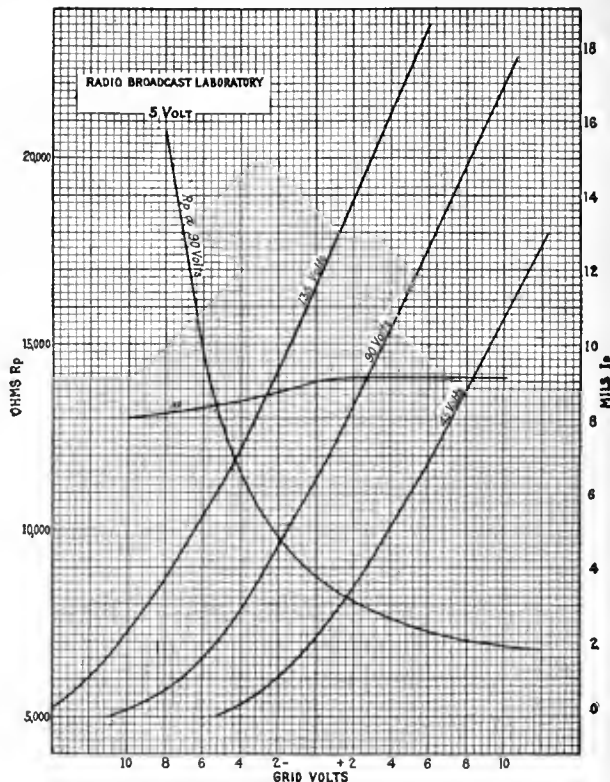

FIG. 11

The effect of grid voltage is clearly shown in this figure. Plate current, plate impedance and amplification constant all vary with changes in grid voltage. Mutual conductance may be obtained by dividing the amplification constant by the plate impedance. These curves were made from 201-A type tube

modulated oscillator as described in RADIO BROADCAST for September.

HOW TUBE VALUES ARE FOUND

IN PRACTICE the tube is lighted at its rated voltage, the switches are thrown as indicated, and at silence in the phones, the values are as shown in the Figure. The accuracy of the method is such that one can repeat measurements to within a few per cent. depending upon the accuracy with which the meters can be read and readjusted to proper value. All of the data in Table 3 were taken by means of such a bridge.

Several machines are on the radio market which are useful in measuring the tube constants, but attention must be paid to the methods in which they are used. For instance, one meter submitted to the Laboratory measured the plate impedance by an Ohm's law method. It was argued that from Ohm's law,

$$\text{current} = \frac{\text{voltage}}{\text{impedance}} \text{ or } \text{impedance} = \frac{\text{voltage}}{\text{current}}$$

and from the data used above, impedance =  $\frac{90}{.0076} = 11840$  while the actual impedance as measured on a bridge = 7600 ohms.

The error in using such a meter is explained on page 424 of Prof. Morecroft's Principles of Radio Communication.

In connection with tube constants and their measurements, the question naturally arises, at what values of grid and plate voltage should tubes be measured and rated. At the present time there are several points of view, to judge from the printed matter sent out by tube manufacturers. All tubes rated in the Laboratory are measured under the conditions under which they are usually operated. For example an

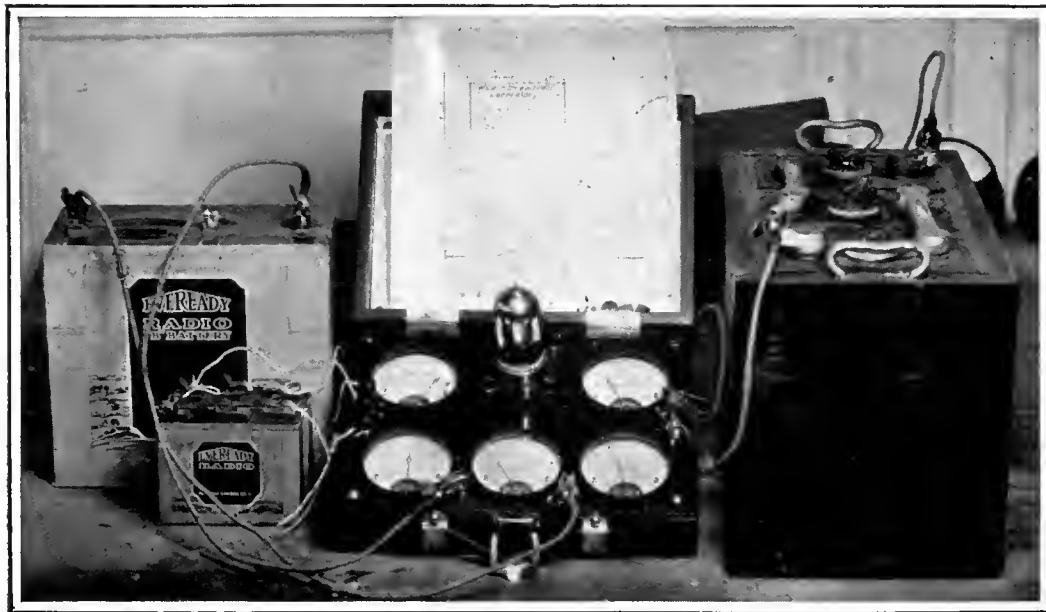

FIG. 10

A laboratory set-up for making characteristic curves of tubes. The group of instruments is a Jewell test set and is made up of plate, grid, and filament voltmeters, and plate and filament ammeters

amplifier is usually operated at 90 volts on the plate and negative 4.5 volts on the grid. The plate current, the amplification constant, the mutual conductance, and the plate impedance will all be different under these conditions than at zero grid voltage. For this reason Laboratory measurements are made under these conditions, notwithstanding that the fact that many tube testers now on the market, and in the hands of tube dealers, have no provision for adding C batteries.

It is to be noted in this connection that the circulars recently sent out by the Radio Corporation give values for these important constants under standard conditions, namely 90 volts plate and negative 4.5 volts grid. To state tube constants at zero grid is to give no indication of what these tubes will do under actual conditions, and for this reason the table of tube data included in this article gives values at the proper C bias.

The reader who is interested in tubes and the proper conditions under which they should work would do well to study the booklet published by the Radio Corporation which gives tube constants for all of the well known detectors and amplifiers. The reader should see that tubes that he buys measure up to these standards,

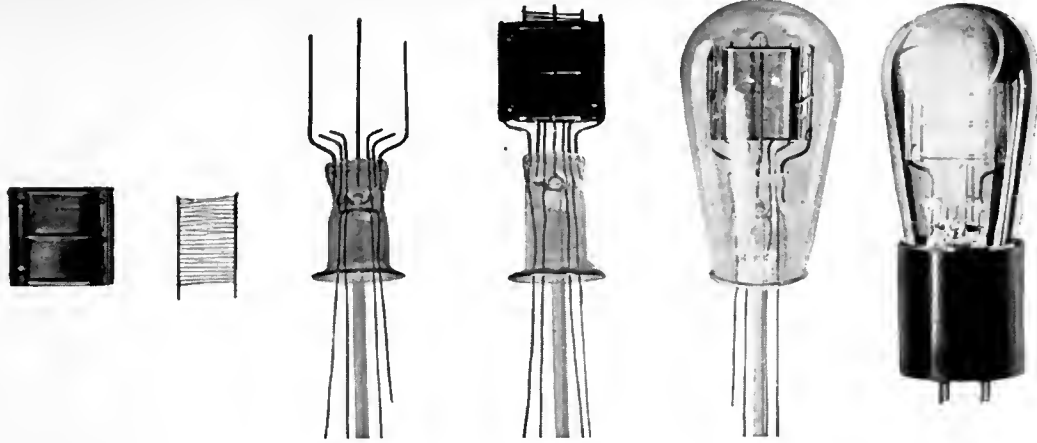

FIG. 12  
The main elements of a standard UV-201A tube

and should not let dealers give him tubes that the dealer has used in his own receiver—for sad to relate, reports come frequently of this nefarious practice.

And the data in the table of tube constants must be considered with the proper respect for what the ear actually hears. For instance a tube with a mutual conductance of 650 will differ but little—as far as the ear is concerned—from one with a conductance of 675 or even greater. It is probable that any of the tubes in this table will give identical results as is pointed out in an interesting manner by a recent booklet on tubes published by the Radiofax Company. The point to be noted is that the average of all those tubes listed is about 650 and that tubes that one buys should be of this order, and not of only 400 or so. Having a tube with a high plate current is no disadvantage, for this current may be reduced

by the use of a C battery. In fact the best tubes obtainable give large plate currents—they are equipped with good, long lived filaments.

From all available data the reader may rest assured that reputable tube manufacturers are doing their best, and that they will be glad to replace a defective tube, provided that it lights. Dry cell tubes are suitable for radio-frequency amplifiers, detectors, and first audio amplifiers, but that for operating a loud speaker without overloading larger tubes must be used with greater values of B and C voltages. It is here that the 112 type tubes of the R.C.A., Cleartron, Sea Gull, Golden Tone, the Daven Mu 6, the 216-A, and others are most useful. The reader is referred to the table in the November RADIO BROADCAST which gives the output of these tubes in undistorted power.

For resistance and impedance-coupled amplifiers, there are several tubes with higher amplification constants that are useful and curves will be found of these tubes in this number. Such tubes are Daven, Cleartron, Golden Tone, and there are doubtless others which have not yet been submitted to the Laboratory.

Tubes are the important items in present day receivers, they make the wheels go round—but they must be operated intelligently, and with care.

NOTE

THE data in Table 4 represents the average of at least four tubes of each manufacturer. It will be noted that it differs in some respects from similar data published in December RADIO BROADCAST. This is due to the fact that some manufacturers, at least, have not decided definitely upon the desired characteristics. It is probable that another month will see other changes and additions to this table. When this article was written (December) this data was the best obtainable from existing tubes.

Throughout this article and in other texts which deal with the subject of vacuum tubes, their characteristic curves, etc., reference is made for convenience's sake to letters and signs intended to represent some constant or value. The

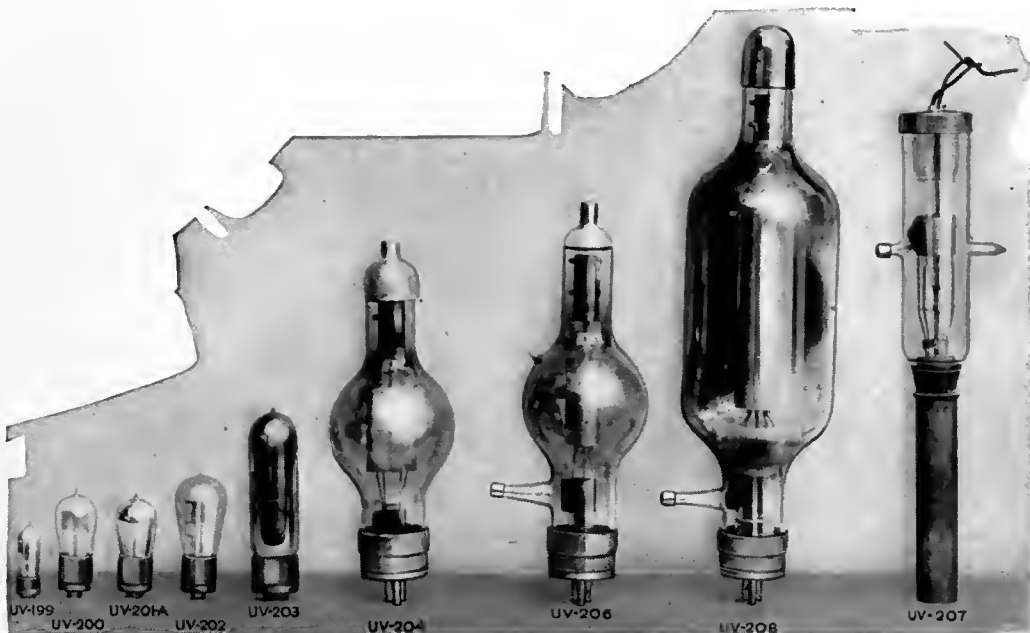

FIG. 13  
The Radiotron family from the little 199 to the big water cooled fellow that is being used at the new wjz and other stations

derivation of these symbols is originally from Ohm's Law where volts is represented by E, amperes by I and resistance by R. The elements of a vacuum tube, the filament, grid and plate are represented by the letters F, G, and P respectively. Now by combining these and

Ef. . Filament Volts  
Ep. . Plate Volts  
Eg. . Grid Volts  
Rp. . Plate Impedance

Ip. . Plate Current  
If. . Filament Current  
 $\mu$ . . Amplification Constant  
Gm. . Mutual Conductance

the letters of Ohm's Law, we can denote a value such as plate voltage by writing Ep. Filament current or amperes would be If and so on.

The symbols designating amplification constant was borrowed from the Greek alphabet and is represented as  $\mu$ . Mutual conductance is usually represented by Gm since G is a symbol for a "conductance," and the term "mutual conductance," m, was coined by Prof. Hazeltine.

Following is a list of letter symbols most commonly used, with their meaning.

# The 1926 International Radio Broadcasting Tests

What Radio Listeners Everywhere May Expect in the Most Comprehensive International Tests Ever Arranged—The Final Transmitting Schedules

By WILLIS K. WING

**B**ASED on previous experience, the January International Radio Broadcast Tests should mark a distinct advance over the others held," says Captain Eckersley, chief engineer of the British Broadcasting Company, in a radiogram just received by RADIO BROADCAST. "It should be possible," he continues, "with the coöperation and assistance of the International Bureau de Radiophonie recently organized at Geneva, to secure more definite and accurate data on the test broadcasting of all the European stations than in the Tests of November 1924. All listeners should remember the differences in time, in order to avoid confusion and disappointment. Our council meeting at Brussels during the second week of December, at which representatives of all English and Continental broadcasters took part showed a most commendable spirit of coöperation on the part of all concerned.

"We believe that radio, intelligently developed in the public interest is destined to become a potent auxiliary of international coöperation in bringing closer together broadcast listeners and wireless enthusiasts all over the world. Radio should perform valuable work in establishing common points of interest and in consolidating conscious world citizenship without which there can be no assurance of permanent peace between nations," concludes Captain Eckersley.

The idea of the International Tests originated with Mr. F. N. Doubleday, president of Doubleday, Page & Company, on his return from a trip to England in 1923, during which time he had made a detailed study of radio broadcasting there. Mr. Doubleday felt that it would be extremely interesting and stimulating both to the progress of radio and to international friendship were it possible for RADIO BROADCAST to arrange a program of broadcasting from this country to England. So it was arranged that a two-way test should be held. And during the last week in November, 1923, the first International Tests took place, between the broadcasters of England and America. The plans were not extensive, but the success of listeners on both sides of the water, in logging broadcasters at great distances was really extraordinary. And the second series of tests, during the last week of November, 1924, more ambitious than the first, since Continental

broadcasters were invited to participate, boasted a huge total of listeners in the United States and in England who received stations foreign to them. This is all the more remarkable because in both years, atmospheric conditions were certainly not all that could be desired. In addition to the mere DX features of the first two Tests, there was the side, perhaps not so evident, but really none the less important, that radio enthusiasts on both sides of the water were bending their thoughts toward a kind of international radio unity. To the American listeners, the English and Continental peoples seemed closer, as indeed they were, than ever before. And the same may be said of the English listeners.

#### EUROPEAN PARTICIPATION GREATER

**T**HE 1924 Tests inaugurated the broadcasting of European stations, and the Tests of 1926 will see the European and the British stations in fuller coöperation

than ever before. This increased coöperation is due to the recent organization of the International Bureau de Radiophonie, with headquarters in Brussels, headed by Arthur Burrows, formerly chief program director for the British Broadcasting Company. The European broadcasters have realized that broadcasting is not a sectional or national matter, and that they must arrange their affairs so that all listeners may benefit, and the international bureau, which attempts to settle wavelength allotments and allied problems, is the logical result.

The success of the International Tests depends entirely on the coöperation of all the broadcasters, because silent hours, allowing for the uninterrupted reception of stations outside national boundaries is essential. And in this respect, the American and Canadian stations have definitely demonstrated their feeling that the Tests meant enough to radio for them to make special sacrifices. These sacrifices have been greater for the American and Canadian stations than they have for those of the other nationals, because these Tests have come on this side of the water during the regular evening hours of broadcasting, while the difference of time between the American continent and Europe has called the foreign broadcasters from their more or less downy couch at three o'clock in the morning, and no paraphrase of a once popular song meant.

But what is going to happen this year? The editors of RADIO BROADCAST felt that the International Tests had grown too big for any one organization in this country to assume entire charge. So the matter of the Tests was put up to many organizations, including the Radio Manufacturers Association and the National Radio Trade Association who felt that so important an event to the radio world should not continue without their active support. The result has been that about eighteen organizations devoted to furthering the interests of radio have aligned themselves with this movement. So in the United States this year, the International Radio Broadcast Tests are not supported and supervised by RADIO BROADCAST alone, but by all the influential organizations in radio. And in Europe, the aid of the three most powerful radio groups has been enlisted, the British Broadcasting Company, the International Bureau de Radiophonie, and



"FOR SERVICES RENDERED"

In arranging the International Test. Presented to the editor of this magazine at the recent New York Radio Show





RECEIVING FOREIGN STATIONS

During the International Tests of 1924, at Mitchel Field, New York. This Army radio truck was driven to the center of the field, and a superheterodyne set up and many stations were heard. Light was furnished by lanterns and flashlights

Radio Press, the latter controlling a circulation of radio readers in England totalling more than a million. Mr. Scott-Taggart, the editor-in-chief of all the Radio Press publications has been appointed, jointly with Captain Eckersley, chief engineer of the British Broadcasting Company, as heads of the European broadcasting program during these Tests.

In the United States and Canada, the broadcasters, at a considerable sacrifice, have arranged their programs so that silent hours are provided. The activities during this test week also involve Mexican and Cuban and South American stations. Among the South American stations participating is OAX, at Lima, Peru, owned by the Peruvian Telephone Company, operating on a wavelength of 380 meters ( 789 kc.). The Cuban broadcasters are directed by Frank H. Jones, owner of the famous Cuban station 6 kw. Canadian broadcasters are operating under the direction of Jacques Cartier, director of station CKAC, *La Presse*, Montreal.

UNUSUALLY INTERESTING PROGRAMS

A GREAT number of American stations are arranging special programs for the American test period, which is from 10 to 11 P. M., Eastern Standard time. Mr. A. Atwater Kent, whose excellent radio programs through the WEAf chain of stations are so popular, expects to present a program of more than usual interest to listeners on both sides of the water. This program will be broadcast the first night of the Test Week, Sunday, January 24, 1926. Those in charge of work at Newark admit that their program for the Test week will offer some genuine surprises. This station was heard abroad in both the previous tests. Station wvj, the Detroit News, is planning features of unusual interest during their transmitting period for over-seas listeners. This is true of practi-

cally every broadcasting station on this side of the water, and to list all the special plans of all the broadcasters would take far more space than can be spared in RADIO BROADCAST. Every individual and organization in any way connected with International Radio Week realizes that this year there is an opportunity to share in an international party of huge proportions.

The Tests were scheduled this time for the last week in January, instead of the last week in November, because receiving conditions are much better in January than in November.

This was found to be true by the experience gained in the first two Tests and we firmly believe that receiving conditions will give a greater number of

listeners a better chance to hear foreign stations. Tests recently conducted by the Bureau of Standards on the transmissions of KDKA at Pittsburgh, seemed to show that the worst atmospherics were found in June, and the least in February, with the next best months in the following order: March, January, November, December, May, October, April, August, July, and September. The worst fading was encountered in October and the least in February. Fading increased in the months in the following order: April, July, March, June, January, May, November, December, August, and September. These results, while not conclusive, certainly point to the last week in January as a very favorable time to schedule the Tests.

The final schedules and latest information about the Tests will of course appear in the daily newspapers. This is written some weeks before the Test Week and while the main features of the schedules are settled, there are many details which cannot be announced until a few days before the first night of the Tests.

Wavelengths and call signals of the European stations have been subject to many changes since the organization of the International Bureau de Radiophonie and

Schedule of Transmissions International Radio Broadcast Tests of 1926

All the Times in This Table are Eastern Standard

DAY	TIME	STATIONS PARTICIPATING
Sunday, 24th January	10—11 P. M.	Canadian, United States, Mexican, Porto Rican, Cuban
Sunday, 24th January	11—12 P. M.	Foreign (British, French, German, Dutch Spanish, Italian, Austrian, Czech, Polish and South American stations)
Monday, 25th January	10—11 P. M.	American Continent (as shown above)
Monday, 25th January	11—12 P. M.	Foreign (as shown above)
Tuesday, 26th January	10—11 P. M.	American
Tuesday, 26th January	11—12 P. M.	Foreign
Wednesday, 27th January	10—11 P. M.	American
Wednesday, 27th January	11—12 P. M.	Foreign
Thursday, 28th January	10—11 P. M.	American
Thursday, 28th January	11—12 P. M.	Foreign
Friday, 29th January	11—11:15 P. M.	American Eastern Standard Time Zone stations
	11:15—11:30 P. M.	American Central Standard Time Zone stations
	11:30—11:45 P. M.	American Mountain Time Zone stations
	11:45—12 P. M.	American Pacific Time Zone stations
Saturday, 30th January	11—11:15 P. M.	All Canadian stations
	11:15—11:30 P. M.	Northern half United States stations
	11:30—11:45 P. M.	Southern half United States stations
	11:45—12 P. M.	All stations south of the United States

It will be noted that this schedule will not only give American listeners a chance to hear stations in this country never heard before because of the station operating on a frequency used by some near-by station, but this arrangement will also give the overseas listeners a chance to pick up some American stations that are more distant from them than the stations almost on the edge of the Eastern seaboard. The arrangement of the American tests so that on the first night (Friday, American time) the stations will progressively transmit from east to west, and on the second night of those tests (Saturday, American time) transmit north and south, will give American listeners a chance to experiment with DX reception such as they have never before had.

The Continental and British stations, if they follow the same plan for their territory, on the last two nights of the test, will be on the air just one hour earlier than the American stations. This will keep the air clear for the American transmissions which follow. The British and Continental broadcasters will undoubtedly appreciate this arrangement, for it will give them a chance to get a bit more rest. Since the transmissions from abroad come at from four to five o'clock in the morning, London time, the physical strain on the various station staffs is bound to be quite heavy by the end of the test week.



CUP PRESENTED TO ARTHUR H. LYNCH  
At the recent Chicago Radio Exposition for organizing and arranging the International Tests

so most of the listed frequencies of those stations are not now accurate. On pages 465-6 of this magazine appears as complete and accurate a list of English and Continental broadcasters as is possible to secure.

The main outline of the entire transmitting schedule for all the stations is printed elsewhere in this article and it would be well for listeners to clip that schedule out for reference during the Test Week. As Captain Eckersley suggests in his radiogram quoted above, all listeners should remember that there is a great difference in time. For the convenience of listeners in the United States and Canada, the schedule is made out entirely in Eastern Standard Time. Conversion to the time of the other zones in this country is not difficult. Five British stations including 5 xx, the high power station of the B. B. C., will be on the air for three nights of the test. Although no list is at present available of the European stations participating, the leading continentals will be on the air.

Without any major exception, all the broadcasters in the United States, Canada, Mexico, Cuba, and Porto Rico will be on

the air during their allotted periods. And, a matter of great interest, at least one station on the west coast of South America will be heard, OAX 789 kc. (380 meters) at Lima, Peru. A number of the broadcasters on the east coast of South America are also expected to join in the test broadcasting.

Copies of the Radio Week programs of all the American stations which take part are being forwarded to Mr. Scott-Taggart of Radio Press in London. Radio Press will undertake to verify American programs heard by English and European listeners during the week. And in the United States and Canada, the verification of foreign programs heard will be in charge of the official International Radio Week newspaper in each city. The official programs will be printed the day after they are sent so that all listeners can themselves check their reception.

It is probable that there will be many listeners who will not see the printed newspaper programs and who prefer a verification direct from RADIO BROADCAST. Listeners who want a verification direct may address their telegrams, letters, and long distance calls to International Radio Broadcast Test Committee, RADIO BROADCAST magazine, Garden City, New York. Our long distance telephone number is Garden City 800. Those who wish to address the Committee by amateur radio may do so by filing a message with some amateur operator in their locality and asking him



"BIG BEN"

The famous clock atop the Houses of Parliament whose chimes are frequently broadcast from 2 10 and other stations in the British Broadcasting Company chain. If the English plans work out, listeners on this side of the water may have an opportunity to hear the deep bells of these chimes over their own sets during the January 1926 Tests

to forward it to the above address. The call letters of our amateur radio station are 2 GY, and the station is tuned to 7496 kc. (40 meters).

Good going to you all during the Tests!



THOSE IN CHARGE OF CANADIAN COÖPERATION

The staff of station CKAC, *La Presse* at Montreal. J. N. Cartier, the director of the station, fourth from the left in the illustration, has had charge of the arrangements with all Canadian broadcasters for their part in the Tests. In the back row, from left to right are Arthur Dupont, assistant announcer; Adrien Arcand, radio editor of the paper; Leonard Spencer, technician; J. N. Cartier; A. Lebeau, master of ceremonies; front row: J. P. Calligan, "Father Radio"; Mary Brotman and Nora O'Donnel, stenographers

Distance Computation Chart

MILES TO ↓	FROM →							
	BERLIN	LONDON	MADRID	MOSCOW	NEW YORK	PARIS	ROME	SAN FRANCISCO
Aberdeen	700	400	1180	1514	3280	600	1220	5880
Amsterdam	400	220	940	1350	3300	260	820	5900
Barcelona	950	720	300	1900	3200	540	520	5800
Berlin	—	580	1560	1020	3700	540	740	6300
Bilbao	990	600	200	1980	3050	480	770	5650
Bremen	210	400	1060	1170	3580	400	800	6180
Breslau	190	720	1230	900	3850	650	680	6450
Brunn	280	740	1150	1000	3800	630	510	6400
Brussels	500	200	830	1420	3240	160	730	5840
Buda Pesth	430	880	1200	1000	4000	750	500	6600
Cadiz	1460	1110	310	2420	2900	970	1050	5500
Cardiff	700	140	780	1680	3000	300	1020	5600
Chicago	4400	3900	3800	5400	750	3800	4700	1820
Cleveland	4000	3550	3500	5100	400	3500	4400	2140
Copenhagen	280	600	1310	1000	3700	640	950	6300
Daventry	600	80	850	1780	3200	290	1190	5800
Dresden	100	590	1110	1050	3650	520	640	6250
Dublin	820	300	930	1760	3000	500	1170	5600
Geneva	700	460	630	1500	3300	250	430	5900
Glasgow	760	340	1100	1650	3150	580	1230	5750
Habana	4500	3580	3250	5000	1350	3700	3900	3950
Helsingfors	700	1160	1860	570	4300	1210	1390	6900
Lausanne	520	460	660	1460	3550	260	430	6150
Lisbon	1840	1020	300	2450	2800	940	1140	5400
London	580	—	800	1580	3200	220	880	5850
Los Angeles	6300	5700	5600	7280	2560	6000	6300	5160
Lyons	610	460	580	1560	3200	250	460	5800
Madrid	1560	800	—	2130	3100	670	830	5500
Mexico City	6000	4300	4100	5900	2200	4400	4400	1270
Milan	530	590	730	1430	3800	390	300	6400
Moscow	1020	1580	2130	—	4600	1540	1490	7300
Newcastle	640	260	1040	1540	3400	460	1110	6000
New York	3700	3200	3100	4600	—	3350	3700	2600
Oslo	540	720	1510	1060	3900	850	1260	6500
Paris	540	220	670	1540	3350	—	680	6000
Prague	180	620	1100	1040	3700	530	580	6300
Reval	660	1130	1840	550	4300	1160	1330	6900
Rome	740	880	830	1490	3700	680	—	6400
San Francisco	6300	5850	5500	7300	2600	6000	6400	—
Toulouse	830	570	330	1790	3150	380	560	5750
Vienna	330	750	1140	1060	3900	620	480	6500
Warsaw	320	890	1410	720	4000	850	830	6600

Eight

RADIO BROADCASTS

Booklet of

European  
South American  
Mexican  
and  
Cuban

Broadcasting Stations

January 15th, 1926

Compiled by  
LAWRENCE W. CORBETT

LOCATION	CALL SIGNAL	FREQUENCY IN KC.	WAVELENGTH IN METERS	POWER IN WATTS
<b>NORWAY</b>				
Oslo	OSLO	785	382	1000
<b>PERU</b>				
Lima	OAX	789	380	1500
<b>POLAND</b>				
Warsaw	—	779	385	1000
Warsaw	—	779	385	300
<b>PORTO RICO</b>				
San Juan	WKAQ	882	340	500
<b>PORTUGAL</b>				
Lisbon	PIAA	937	320	—
Lisbon	—	750	400	1500
Montesanto	—	122	2450	1500
<b>RUSSIA</b>				
Moscow	—	821	365	1000
Moscow	—	666	450	1000
Moscow	—	297	1010	1000
Moscow	—	207	1450	12,000
Nijni-Novgorod	—	2998	100	1000
<b>SPAIN</b>				
Barcelona	EAJ 1	923	325	1000
Barcelona	EAJ 13	652	460	1000
Bilbao	EAJ 9	999	300	1000
Bilbao	EAJ 11	923	325	1000
Bilbao	—	723	415	1000
Cadiz	EAJ 3	833	360	1000
Cadiz	EAJ 10	909	330	1000
Madrid	EAJ 2	967	310	3000
Madrid	EAJ 4	983	305	1000
Madrid	EAJ 6	765	392	3000
Madrid	EAJ 7	735	408	6000
Madrid	EAJ 15	612	490	1000
San Sebastian	EAJ 8	867	346	3000
Seville	EAJ 5	857	350	1000
Valencia	EAJ 14	750	400	1000
<b>SWEDEN</b>				
Boden	SASE	219	1370	1500
Goteborg	SASB	769	390	500
Joenkoepping	SMZD	1131	265	1000

Six

LOCATION	CALL SIGNAL	FREQUENCY IN KC.	WAVELENGTH IN METERS	POWER IN WATTS
<b>CUBA—Continued</b>				
Habana	2 HP	1016	295	100
Habana	2 JP	1110	270	20
Habana	2 XX	1999	150	5
Habana	2 CX	937	320	10
Habana	2 AB	1276	235	10
Habana	PWX	7496	400	500
Habana	2 JL	1090	275	5
Habana	2 EP	845	355	400
Habana	2 CG	857	350	15
Habana	2 BB	1176	255	15
Habana	2 MG	1071	280	20
Habana	2 OK	833	360	100
Habana	2 OL	999	300	100
Habana	2 RY	1764	170	5
Habana	2 TW	1304	230	20
Habana	2 UF	1131	265	10
Habana	2 RK	967	310	20
Habana	2 PK	1538	195	10
Matanzas	5 EV	833	360	10
Nueva Gerona	8 JQ	1333	225	20
Puerto del Rio	1 AZ	1090	275	5
Sagua la Grande	6 HS	1499	200	10
Santiago	8 FU	1333	225	15
Santiago	8 BY	1199	250	100
Santiago	8 HS	1499	200	20
Santiago	8 IR	1578	190	20
Santiago	8 JQ	2306	130	20
<b>CZECHO SLOVAKIA</b>				
Brunn	OKB	167	1800	1000
Prague-Strasnice	OKP	584	513	5000
<b>DENMARK</b>				
Copenhagen	—	973	308	1000
Hjorring (relay)	—	240	1250	—
Lyngby	—	387	775	500
Lyngby	OXE	125	2400	2500
Odense (relay)	—	316	950	1000
Ryvang	—	261	1150	1000
<b>ESTHONIA</b>				
Reval	—	857	350	—
<b>FINLAND</b>				
Helsingfors	—	810	370	—
Skatudden	—	714	420	1000
Tammerfors	3 NB	999	300	250

Three

LOCATION	CALL SIGNAL	FREQUENCY IN KC.	WAVELENGTH IN METERS	POWER IN WATTS
<b>ARGENTINE</b>				
Buenos Aires . . . . .	LOR	750	400	500
Buenos Aires . . . . .	LOV	857	350	500
Buenos Aires . . . . .	LOW	917	327	500
Buenos Aires . . . . .	LOX	800	375	500
Buenos Aires . . . . .	LOY	923	325	500
Buenos Aires . . . . .	—	705	425	1000
Mendoza City . . . . .	LOU	790	380	500
<b>AUSTRIA</b>				
Graz . . . . .	—	742	404	500
Vienna . . . . .	ORV	566	530	2000
<b>BELGIUM</b>				
Brussels . . . . .	Radio Belgique	1131	265	2500
<b>BRAZIL</b>				
Bahia . . . . .	—	857	350	—
Bahia . . . . .	—	—	—	500
Bello Horizonte . . . . .	SPH	961	312	500
Bello Horizonte . . . . .	—	810	370	500
Pernambuco . . . . .	—	857	350	—
Porto Alegre . . . . .	RSR	787	381	80
Recife . . . . .	—	967	310	300
Rio de Janeiro . . . . .	SPE	790	380	500
Rio de Janeiro . . . . .	SPE	961	312	500
Rio de Janeiro . . . . .	SQE	750	400	—
Sao Paulo . . . . .	—	750	400 (approx.)	100
Sao Paulo . . . . .	—	857	350	10
<b>CHILE</b>				
Santiago . . . . .	CRC	779	385	350
Santiago . . . . .	RC	857	350	30
Santiago . . . . .	—	833	360	1200
Santiago . . . . .	ORC	697	430	—
Valparaiso . . . . .	ACB	750	400	50
<b>CUBA</b>				
Caibarien . . . . .	6 EV	1200	250	50
Camaguey . . . . .	7 AZ	1333	225	10
Camaguey . . . . .	7 SR	857	350	500
Central Tuinicu . . . . .	6 KW	882	340	100
Central Tuinicu . . . . .	6 JK	1090	275	100
Camajuani . . . . .	6 YR	882	200	20
Ciego de Avila . . . . .	7 BY	1280	235	20
Cienfuegos . . . . .	6 JQ	1090	275	10
Cienfuegos . . . . .	6 BY	999	300	100

Two

LOCATION	CALL SIGNAL	FREQUENCY IN KC.	WAVELENGTH IN METERS	POWER IN WATTS
<b>SWEDEN—Continued</b>				
Norrkoeping . . . . .	SMVV	1153	260	1000
Malmö . . . . .	SASC	1110	270	1000
Stockholm . . . . .	SASA	702	427	1000
Stockholm . . . . .	—	681	440	1000
Sundswall . . . . .	SASD	550	545	1000
<b>SWITZERLAND</b>				
Berne . . . . .	—	993	302	500
Geneva . . . . .	HB 1	273	1100	1500
Lausanne . . . . .	HB 2	353	850	500
Zurich . . . . .	RGZ	582	515	500
<b>URUGUAY</b>				
Montevideo . . . . .	—	857	350	—
<b>VENEZUELA</b>				
Caracas . . . . .	—	750	400 (Approx.)	—

**Instructions**

**T**O ASSEMBLE this eight-page booklet of foreign broadcasting stations, first cut the sheet on which the call signals are printed, from the magazine. It is best to employ a razor blade for this operation. Then trim the sheet along the outside border line. Do not cut down the center vertical lines. These are used as a folding guide only. The sheet is next cut in two, across the center horizontal line. The two pieces (each consists of four booklet pages, of course) are then folded down their vertical centers and inserted into each other so that the numbered booklet pages run concurrently.

The distances given in the chart on page eight of the booklet are only approximately correct, but are sufficiently accurate to serve a useful purpose.

Seven

LOCATION	CALL SIGNAL	FREQUENCY IN KC.	WAVELENGTH IN METERS	POWER IN WATTS
<b>FRANCE</b>				
Agen . . . . .	—	943	318	250
Grenoble . . . . .	—	357	840	150
Lyons . . . . .	—	1086	276	300
Lyons . . . . .	YN	631	475	300
Marseilles . . . . .	—	857	350	300
Paris . . . . .	SFR	168	1780	4000
Paris . . . . .	5 NC	869	345	500
Paris . . . . .	FPTT	655	458	500
Paris . . . . .	8 AJ	168	1780	100
Paris (Eiffel Tower) . . . . .	FL	113	2650	4000
Toulouse . . . . .	—	109	274	2000
Toulouse . . . . .	MRD	952	315	250
Tours . . . . .	YG	120	2500	500
<b>GERMANY</b>				
Berlin . . . . .	—	594	505	4500
Berlin . . . . .	—	520	576	2000
Bremen (relay) . . . . .	—	1075	279	1000
Breslau . . . . .	—	717	418	1500
Brunswick . . . . .	—	1176	255	1500
Cassel (relay) . . . . .	—	1041	288	1500
Dortmund . . . . .	—	1059	283	500
Dresden (relay) . . . . .	—	1027	292	1000
Eberswald . . . . .	—	1071	280	1000
Elberfeld . . . . .	—	1204	249	500
Frankfort . . . . .	—	638	470	1500
Gleitwitz . . . . .	—	1195	251	1500
Hamburg . . . . .	—	759	395	1500
Hanover (relay) . . . . .	—	1013	296	1000
Königsberg . . . . .	—	648	463	1500
Königswusterhausen . . . . .	—	231	1300	5000
Leipzig . . . . .	—	663	452	1500
Munich . . . . .	—	618	485	1000
Munster . . . . .	—	731	410	1500
Nuremberg (relay) . . . . .	—	882	340	1000
Stuttgart . . . . .	—	677	443	1500
<b>GREAT BRITAIN</b>				
Aberdeen . . . . .	2 BD	606	495	1500
Belfast . . . . .	2 BE	681	440	1500
Birmingham . . . . .	5 IT	626	479	1500
Bournemouth . . . . .	6 BM	777	386	1500
Bradford . . . . .	2 LS	967	310	200
Leeds . . . . .	—	867	346	200
Cardiff . . . . .	5 WA	849	353	1500
Daventry . . . . .	5 XX	187	1600	20,000
Dundee . . . . .	2 DE	906	331	200
Edinburgh . . . . .	2 EH	914	328	200
Glasgow . . . . .	5 SC	711	422	1500

Four

LOCATION	CALL SIGNAL	FREQUENCY IN KC.	WAVELENGTH IN METERS	POWER IN WATTS
<b>GREAT BRITAIN—Continued</b>				
Hull . . . . .	6 KH	895	335	200
Liverpool . . . . .	6 LV	952	315	200
London . . . . .	2 LO	821	365	3000
Manchester . . . . .	2 ZY	793	378	1500
Newcastle . . . . .	5 NO	742	404	1500
Nottingham . . . . .	5 NG	920	326	1500
Plymouth . . . . .	5 PY	887	338	200
Sheffield . . . . .	6 FL	996	301	200
Stoke on Trent . . . . .	6 ST	980	306	200
Swansea . . . . .	5 SX	622	482	200
<b>HOLLAND</b>				
Amsterdam . . . . .	PCFF	154	1950	1000
Amsterdam . . . . .	PX 9	280	1070	400
Amsterdam . . . . .	—	140	2125	1000
Bloemendaal . . . . .	—	869	345	5000
Hilversum . . . . .	HDO	286	1050	2500 up
Utrecht . . . . .	—	273	1100	2000
<b>HUNGARY</b>				
Buda Pesth . . . . .	—	549	546	2000
<b>IRISH FREE STATE</b>				
Dublin . . . . .	2 RN	769	390	1500
<b>ITALY</b>				
Milan . . . . .	SITI	650	545	500
Rome . . . . .	IRO	705	425	1500
Rome . . . . .	—	167	1800	500
<b>MEXICO</b>				
Chihuahua City . . . . .	CZF	923	325	250
Mazatlan . . . . .	CYR	631	475	250
Merida . . . . .	CYY	546	549	100
Mexico City . . . . .	CYA	999	300	500
Mexico City . . . . .	CYB	1090	275	500
Mexico City . . . . .	CYH	800	375	100
Mexico City . . . . .	CYL	750	400	500
Mexico City . . . . .	CYO	705	425	100
Mexico City . . . . .	CYX	923	325	500
Mexico City . . . . .	CZE	857	350	500
Mexico City . . . . .	CZ1	666	450	—
Puebla City . . . . .	CYU	961	312	100
Tampico . . . . .	CYE	833	360	—
Tampico . . . . .	CYQ	931	322	100
Vera Cruz . . . . .	CYC	999	300	—
Vera Cruz . . . . .	CYD	1199	250	—

Five

# AS THE BROADCASTER SEES IT

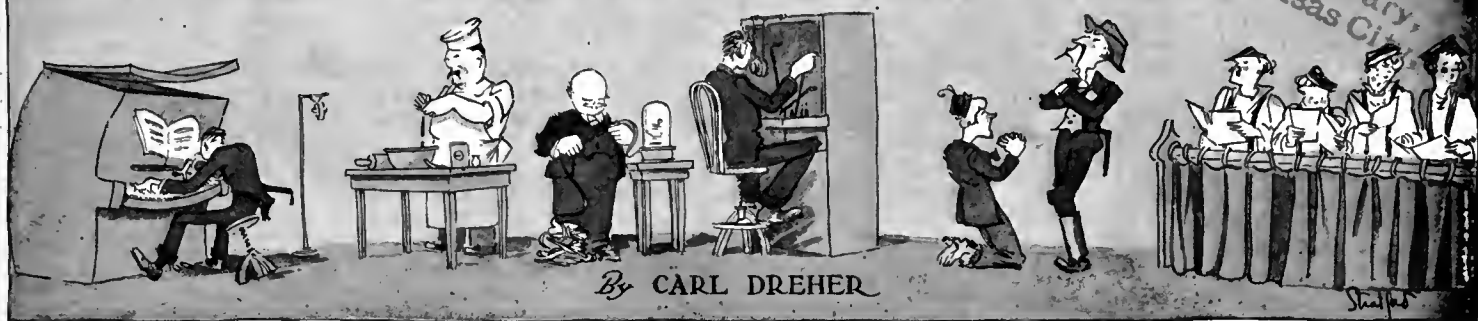

Drawings by Franklyn F. Stratford

## What the Institute of Radio Engineers Does for Radio

**T**HE Institute of Radio Engineers is a learned society devoted to the advancement of radio communication in all its aspects, theoretical and practical.

The term "radio communication," it must be understood, includes a great deal besides broadcasting. To old radio telegraph engineers, broadcasting is only the frothy comedy of radio. What does it matter, they ask, whether the ether is burdened with all these pretty tunes and smart talks; no one is going to die if they fail to reach the receivers waiting for them. An sos call on the high seas is another matter. So they stick to their dots and dashes.

The Institute, however, keeps pace impartially with the developments in radio telegraphy and telephony. As a matter of fact, the two arts rest on the same principles and most of the articles appearing in the *Proceedings*, published six times a year by the society, are of equal interest to specialists in both fields. If an engineer makes some experiments on field intensity of a transmitter at various points, the presence of shadows, dead spots, etc., the results are equally applicable to telegraph transmitters and broadcasting stations in or near the frequency bands covered. The differences between wireless telegraphy and telephony, important as they are, are much fewer than the similarities.

Practically every technical radio man of prominence in the United States, and many in other countries, are members of the Institute of Radio Engineers. But membership is not confined to these eminent figures. The total membership is in the neighborhood of 3000, divided into four grades according to experience and professional standing. At the head are about 100 Fellows, followed by some 500 full Members. These are very largely professional radio engineers and administrators. The 2400 Associate Members comprise the body of the membership. There are also approximately 150 juniors under 21 years of age.

It is not generally known that any responsible person who is seriously interested in radio, in either an amateur or professional capacity, is welcomed to associate membership in the Institute, as long as he or she can pay the dues of \$6.00 per year assessed in this grade. As a matter of fact, the Associate gets as much for his \$6.00 as the Fellow for his annual payment of \$15.00. He may attend meetings. He may contribute to the *Proceedings* if he has something worth while to say. He can't be President,

but his vote counts as much as any one else's. If he makes a great invention he is just as eligible for the gold medal or the Liebmann Memorial Prize of \$500, both awarded yearly. Above all, he gets his six copies of the *Proceedings* every year. In 1924 the volume ran to 864 pages of reading matter, printed in admirable format with full illustrations and charts, making a thick book of information absolutely indispensable to anyone whose interest in radio is above the twelve-year-old level. How the Institute does it I don't know, although the fact that a number of \$20,000-a-year men give a portion of their time to running it, free, gratis, for nothing, as they say in the backwoods, must have something to do with it. Anyway, there's the book. The subscription price to non-members is \$9.00, and it is worth that.

Members of the Institute in any grade must be passed on and elected by the Board of Direction. Application blanks may be secured from the Secretary, at 37 West 39th St., New York, New York. If the application is for one of the two top grades it must be accompanied by the recommendation of five members in that grade, and the Board goes over it very exactly. There are rigid constitutional requirements which must be met. A Fellow must be not less than thirty years of age; he must have been in the active practice of his profession for at least seven years, including three years of responsible charge of important radio work—and "important" does not mean running a peanut roaster broadcasting station or designing still another receiver which is called a uni-control because you have to move six knobs, one big and five small, in order to tune it. A Member-applicant's record is also subject to critical scrutiny; but the section of the constitution referring to Associates states merely that "An Associate shall be not less than twenty-one years of age and shall be: (a) a radio engineer by profession; (b) A teacher of radio subjects; (c) A person who is interested in and connected with the study or application of radio science or the radio arts." That lets in everyone who wants to join and who pays his debts and does not throw bombs at the constituted authorities, invent perpetual motion machines, or sell pill-box static eliminators. Through affiliation with the Institute, one is definitely known as a person active in the development of radio communication, and, aside from the tangible advantages realized, it is about the most practicable means

of testifying to a genuine interest in the art. Not without reason, some employers in technical radio pursuits consider membership in the Institute of Radio Engineers as one evidence of serious devotion to the problems of advancing and establishing radio communication.

The principal section of the Institute is in New York City, where the attendance at meetings is such that it is necessary to hold them in the large Engineering Societies Building auditorium. However, good-sized sections have also been organized in Washington, District of Columbia, Boston, Massachusetts, Seattle, Washington, San Francisco, California, Philadelphia, Pennsylvania, Chicago, Illinois, and Toronto, Canada. These bodies hold meetings, usually each month, in their respective towns. Important engineering papers are presented and discussed at these gatherings. It is no exaggeration to say that no important radio achievement of a technical nature has appeared without being introduced to the engineering fraternity in this way. Foreign engineers, as well as Americans, contribute to the material presented at these meetings and later published in the *Proceedings*, thus giving the papers and discussions an international flavor in keeping with the nature of an art which knows no national boundaries or artificial limits in its mechanism.

The Institute maintains various committees which systematize forms and procedure in their various fields. For example, there is a Standardization Committee which has the job of keeping technical nomenclature and terminology abreast of the times, so that everyone interested may know the correct and accurate use of the various terms. This committee and its subcommittees issue detailed standardization reports every few years.

The officers of the Institute of Radio Engineers for 1926 are Donald McNicol (President); Ralph Bown (Vice-President); Alfred N. Goldsmith (Secretary and Editor of Publications); Warren F. Hubley (Treasurer); Edward Bennett, Lloyd Hespenschied, Louis A. Hazeltine, John V. L. Hogan, John H. Morecroft, A. H. Grebe, Melville Eastham, and A. E. Reoch (Managers). The Past Presidents are R. H. Marriott, G. W. Pickard, L. W. Austin, John Stone Stone, A. E. Kennelly, M. I. Pupin, G. W. Pierce, J. V. L. Hogan, E. F. W. Alexanderson, Fulton Cutting, Irving Langmuir, J. H. Morecroft, and J. H. Dellinger. Doctor Kennelly is also a Past President of the American Institute of Electrical

Engineers, with which the Institute of Radio Engineers maintains close and cordial relations; and Doctor Pupin, the President of the A. I. E. E. at this time, is the second engineer to hold these two important offices during his career.

I do not go in much for exhorting the populace or inflicting advice on my fellow citizens, but I will say to any technical broadcasters who happen to read this, as well as any one seriously interested in radio work, amateur or professional, that they are very definitely getting off on the wrong foot if they have neglected to affiliate themselves with the Institute of Radio Engineers. Personally, I have never joined any fraternities, lodges, churches, sodalities, temperance societies, police reserve organizations, *turn vereine*, unions, or pacifist brotherhoods. I declare, with several thumps on my chest, that I am as little inclined toward joinery, in the large, as an Anatole France or a Rémy de Gourmont. But I have belonged to the I. R. E. since considerably before the time when I became eligible to vote, and intend to remain in it until I become too weak to earn \$10.00 a year. The sixty or seventy dollars which I have paid in dues during that decade have been among the best investments I have ever made, and if you are a radio engineer, operator, amateur or experimenter still on the outside, permit me to give you this tip and to urge you to send for the application blank, as the correspondence schools say, NOW.

## Technical Routine in Broadcasting Stations. II. Control Work

THIS is the sixth of a series of practical articles for professional broadcasters. Articles previously published are three on microphone placing (September, and October, 1925; and January, 1926); one on personnel and organization in a typical large station (November, 1925); and one relating to wire lines as employed in broadcasting (December, 1925). This last-named paper was the first of a number under the general heading of Technical Routine in Broadcasting Stations, and this discussion will now be continued with a consideration of the functions and problems of broadcast control work.

Essentially the control room is a small telephone exchange. We have a radio telephone transmitter to which various places—studios and a variety of field points—are to be connected in a pre-arranged order and for more or less

definite periods. The control room makes these connections. It (meaning the men in the control room) also "lines up" the various field points, making sure that each will be ready to broadcast when the program is handed over to it. The control room supervises the output, and adjusts the over-all amplification of the station to appropriate levels, as required by changing inputs and the characteristics of the equipment. And when the station in question is connected to other stations, hundreds or thousands of miles away, "feeding" them a portion of its own animating energy, the work of the control men is further increased. These operators, therefore, are highly trained technicians, not, like wire telephone operators, automations mechanically doing the bidding of the people who use the telephone facilities. The work of local telephone operators can be done, and is being done better by machine switching equipment than human beings can do it. When it comes to long lines and toll telephony, the procedures become somewhat too intricate for successful mechanization. The control room of a broadcasting station contains most of the complications of long distance wire telephony, plus complexities of its own. If we are to see the day when machinery takes the place of the control operators, we shall have to get a good deal older.

One of the essential elements in good control work, nevertheless, is an almost machine-like uniformity in procedure. In putting the station on the air, in changing from the studio to the field or vice-versa, in interrupting a field event when necessary, a definite routine should always be followed, to be varied only when it is obviously advantageous for some special reason. Mistakes are less apt to be made when the various steps are always taken in the same order. For example, when the control operator changes over from the studio to an outside point it is generally necessary for him to light a separate amplifier to the input of which the line is connected at the proper time. Unless there is some fixed rule on the subject, there will be occasions when the amplifier is not lighted when the change-over is made. The result is that the opening announcement from the remote point is lost while the control operator rushes madly around tracing the signal and finds he has no voltage on his filament. If, however, it is a regular procedure to light this tube at the beginning of the last studio number, this sort of thing is less apt to occur.

Such instances may be multiplied. It is

found that some specific formula must be used in putting a field event on the air. The control operator should say to the field man: "You're on the air," and wait for the word "Right!" before closing the switch. If various phrases are used the station will inevitably get into trouble. There will be a misunderstanding and some wire talk will go out on the air. Such mishaps occur in most complicated ways. Recently I heard of one which came about through a curious combination of circumstances. A chorus was being broadcast from an opera house, with no audience present. It was a first-class aggregation of sixty trained voices, achieving unusual and very beautiful symphonic effects. After starting the concert the field operator decided he was not getting quite enough bass, and as he was set up near that section of the chorus he ran out his own microphone, which he had been using for communication with the studio before the wire was turned over to the air, some twelve feet, adding it to the two or three concert microphones already set up. Half-way through the program the control operator had occasion to give a brief message to the announcer, something about signing off one of the stations on the chain, and, no extra pair being available, he opened the broadcasting line at what seemed like an opportune moment and called, "Hello." The field operator heard him and made a dash for his microphone. In order to get it he had to take off his shoes, which were on the usual six foot cord. It took him a few seconds to get back with the microphone, and in this interval the control operator gave him the message, which the field man missed, of course. Then the control operator said, "You're on the air," just as the field man was putting on the shoes in more or less confusion and excitement. The control man waited for a reply, and heard some noise which he interpreted as "Dit-Dit"—the Continental code for "I," frequently used as an acknowledgment by this particular field man, who had been a ship operator in his day. So the control put the opera house back on the air. An instant later the field man cried, "What d'you say?" and this went out to Canada and Mexico while the engineers and program managers listening on the outside tore their hair and smashed mirrors without being able to bring it back. The line was immediately opened again and the mess straightened out, but the damage was done. A single slip like that, coming after a majestic oratorio, dispels the dramatic illusion like a half



"IMPORTANT PAPERS ARE PRESENTED AND DISCUSSED AT THE I. R. E."

ton of gun cotton exploded in a haystack. Yet the four or five individual mistakes made by the technical men might occur singly without causing a break. In this case the fates bunched them in such a way that all hands made a show of themselves on the air. A better organized routine procedure would have saved all this.

In most stations, even of the half and one-kilowatt size, all the technical equipment—switchboards, amplifiers, and transmitting set, is found in one room. This is fundamentally wrong. The only advantage is in enabling the station to be run with a small staff, since one or two men are enough to watch the oscillators and modulators, regulate the gain, take care of necessary switching, and keep a 600-meter log. It also means that these men have too much to do, especially when the station gets into trouble, and I have yet to see one which is exempt. At the very least the line switchboard, amplification controls, and first few stages of amplification, should be in one room (the control room) with the heavy machinery elsewhere. The tendency now is to subdivide even further. Thus, there may be a line control room where the various local and out-of-town wires terminate in suitable switchboards. Here the appropriate connections are made and telegraphing over simplex circuits is handled. The noise involved in these operations is in this way kept away from the second control room, where the amplification is adjusted and the output of the station monitored in relative peace and quiet. The men in this division are not responsible for switching; their responsibility is to take what the preceding technicians send them and pass it on to the transmitter with the best possible acoustic quality. The men in the first division take care of the switching and corollary adjustments. The steps then become:

1. Field operators at remote pick-up points;
2. Control operators (switching);
3. Control operators (Amplification and radio quality);
4. Power operators.

The 600-meter watch is best kept, in the majority of cases, by the men in the power plant. It should be kept out of the control room whenever possible; if it must be handled there, a separate operator listening with headphones should be assigned for this purpose. If this job is taken care of in the transmitter plant, a loud speaker may be used and no additional staff is required for this important detail.

## The Memoirs of a Radio Engineer.

### IX

I WENT to the College of the City of New York for two reasons; one was that I had none too much money, and the tuition at the College was free. This, however, was not a major factor; it would not have been an insurmountable difficulty to raise the money for a course at one of the other institutions of learning around town. The principal force which drew me to the City College was the presence in the faculty of physics of a famous radio engineer, Dr. Alfred N. Goldsmith, now Chief Broadcast Engineer of the Radio Corporation of America. As early as 1910 or 1911 the Doctor's renown had spread to the far corner of the Bronx in which I struggled with insensitive pieces of galena, hard visaged janitors who were as ready to cut down an antenna as to step on a cockroach, ten-cent store tools, my own ignorance—all the animate and inanimate obstacles in the path of the young wireless experimenter of that benighted time. Of these

handicaps my lack of knowledge was the greatest, and I hoped to sit at the feet of this preceptor and learn from him the theory and practice of the wireless art.

A prominent college president, in a recent commencement address, advised graduate students not to attend a professional school at random, but to select one at which some outstanding scholar taught the subject in which they were interested, for contact with such a figure would be of incalculable value to aspirants in his specialty. At the mediaeval universities, also, a celebrated professor attracted students, sometimes in enormous numbers; some of the universities, in fact, grew up around such figures. Thus my course in picking a college had ample historical precedent, a fact of which I was probably unaware; all I knew was that I wanted to learn radio, and Doctor Goldsmith could teach me if he desired. In this hope I was not disappointed. If I did not learn radio, the fault was not in my training.

During his teaching years, Doctor Goldsmith instructed, inspired, and in most cases got jobs for some thirty radio engineers, among whom may be named Julius Weinberger, William Priess, Joseph D. R. Freed, Lester Jones, and numerous others. He gave what was probably the first regulation radio engineering course in this country, and certainly one of the best anywhere. His students were picked men, senior students specializing in physics or engineering, who showed special qualifications for an advanced course in radio technique and theory. The classes ran from three to six men in number, an ideal condition in which a "course" ceases to be what is usually meant by the term—something to be "taken" and forgotten. The first class was in 1913, the last in 1918, when the pressure of other responsibilities became too great, and the Doctor was no longer able to devote a considerable portion of his time to a handful of men in this one course. It was not until the end of 1924, however, that he gave up active teaching entirely. He was then an Associate Professor, in charge of the Department of Electrical Engineering at the College of the City of New York.

While teaching physics, electrical engineering, and radio at the College, Doctor Goldsmith was editor of the *Proceedings of the Institute of Radio Engineers*, a position which he still holds, and has held since the Institute was founded in 1912. Since 1918 he has also been Secretary of the Institute. He is, accordingly, one of the charter members and founders of the Institute, and a Fellow from the beginning, with activities dating back to the Society of Wireless Telegraph Engineers and the Wireless Institute, whose combination formed the Institute of Radio Engineers.

Readers who are unfamiliar with these primordial days of organized radio, and its outstanding figures then and now, will probably imagine Doctor Goldsmith as a man of at least sixty. He is in fact thirty-eight years old. In 1913, when I first met him, he was in his twenty-sixth year, already a Ph.D. of Columbia University, and an instructor in physics at the City College. And while he was engaged in all the activities enumerated above, he was also, from 1914 on, Consulting Engineer, and later Director of Research, for various commercial radio companies.

The course in radio engineering was neither my first nor last contact with Doctor Goldsmith. Long before I was qualified for this study, I was one of his students in physics, and a member of the City College Radio Club, founded in 1914, of which the Doctor was the Faculty Advisor, and which he supported liberally, not only with advice, but also with donations of valuable apparatus, so that shortly it became one of the most affluent amateur radio clubs of the city. At the meetings he would frequently appear and lecture for a half hour on some interesting phase of radio to the fifteen or twenty members present. In this way, by virtue of the fact that the Doctor was Chairman of the I.R.E. Committee on Papers, and Editor of the *Proceedings*, the students frequently received summaries and elucidations of important engineering literature soon after presentation. This early contact with first-rate engineering exposition was of course inestimably valuable to the young men in the club.

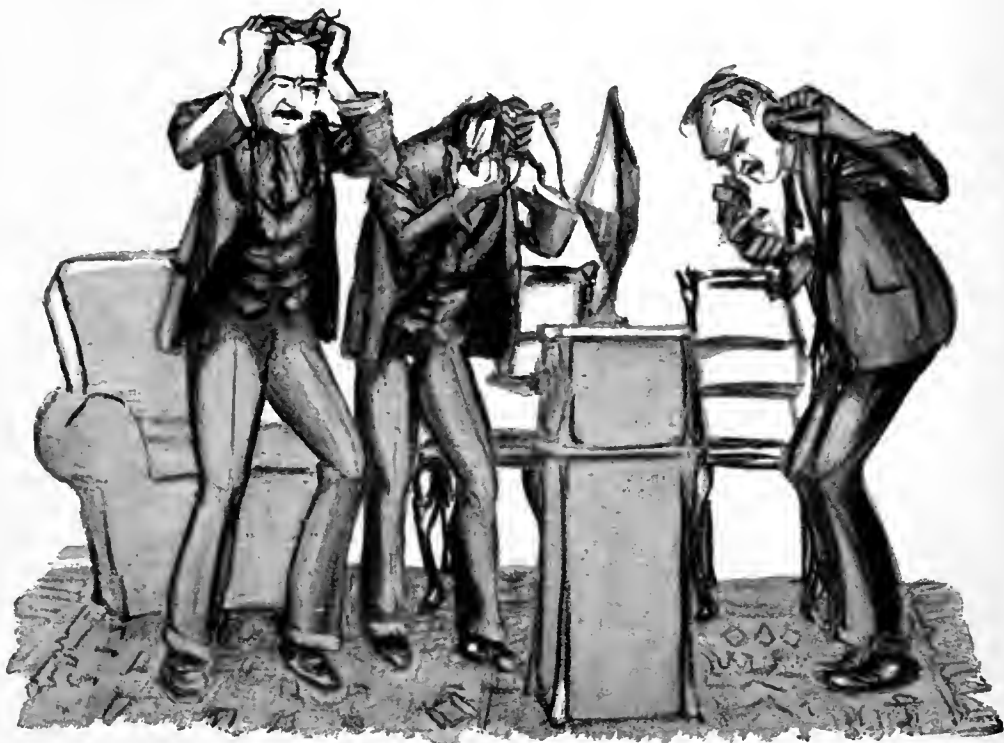

"THE PROGRAM MANAGERS AND ENGINEERS LISTENING ON THE OUTSIDE TORE THEIR HAIR"

In 1913 I was in the graduating class of Townsend Harris Hall, the preparatory school of the College, across the campus from the other college buildings. It was the custom to give these "subfreshmen," during the last semester of their preparatory course, College instructors, space in the Main Building, and other facilities of the university. Accordingly my class in what was known as Physics 2, an elementary course in light, heat, magnetism, and electricity, received its tuition from Doctor Goldsmith. I had seen pictures of him, and recognized him as soon as he came into the room. He was smooth shaven, and it became clear to me immediately that a man could look very much the scientist without the pointed beard which invariably characterizes the profession in the movies. His manner was brisk and businesslike, not at all hurried, but giving the effect of getting to the objective without any delay or vacillation. He knew just what he was doing, and my classmates, who were not above indulging in various monkeyshines if they thought the instructor would let them get away with it, realized, appraising a firm chin and executive-looking eyes, that they would get kindly treatment, but that it would not do to throw chalk, roll dice under the seats, or bring pet fauna into the recitation room. With sinking hearts they resigned themselves to the thought of work.

I got along well enough in this course, having gone over the electricity and magnetism part in my private studies, and in the other branches I studied diligently in order to impress the instructor with my serious intentions. So did a number of the other lads, who also had their eyes on the radio field, although not obsessed by it to the extent I was. We knew of the radio engineering course, P 17, which was that year being given for the first time, and from the lowly position of P 2 we gazed up at the heights with vast curiosity and longing. The radio laboratory, a large room on the ground floor, was always kept locked. One made application to get in after ringing a bell. On a certain day, as three of us were passing the room, the Doctor came by, nodded to us as we touched our hats in accordance with the punctilio of the College,

and went in. Walking nervously up and down the hall, we began to debate as to whether he might show us the laboratory if we could get up courage enough to ask him. Finally one of us pumped up resolution and pressed the push-button for about a quarter of a second. When the door opened we almost turned on our heels and ran, but it was not Doctor Goldsmith. We explained to the College senior who appeared that we were preparatory school students of the Doctor's, and suppliants for a view of the laboratory. In a moment Doctor Goldsmith appeared, received us cordially, and invited us in. This was the first time that I had ever seen commercial radio telegraph equipment and precision radio measurement apparatus, and I was dazzled. The neat ebonite bases, shiny brass fittings, the carefully spaced turns of helical inductances, and all the other marks of good design and workmanship, were fascinating to one used to wooden bases and cheap construction. Of especial interest was a 3 kw. Poulsen arc, presented to the College by Mr. Gano Dunn.

It was a laboratory afternoon for the radio engineering students and they were engaged on the various experiments assigned to them. One squad was measuring the voltage of a quarter kilowatt transformer with an electrostatic voltmeter; another was working with wavemeters; another was taking antenna characteristics, and so on. It would all seem fairly commonplace to me to-day—I mean, I like radio as much as ever, but the magic is no longer there; it is the difference between having a crush on a girl and marrying her. Radio to me to-day is a matter of hiring men, o'king bills, arguing with orchestra leaders, worrying about wire lines, maintenance, costs, and technical bugs; and so on. But on that day, when Doctor Goldsmith showed us around his laboratory, it was pure glamour.

Having introduced Professor Goldsmith into my narrative at this point, I shall have many more occasions to refer to his influence and good will, which were so great an aid to these young men eager to enter the radio field. They were fortunate that for some years before executive functions took over all the Doctor's time, he was able to devote a part of his plentiful energy toward giving them a start. As for me, I feel the obligation to acknowledge my indebtedness to Doctor Goldsmith at this point in my autobiographical sketches. Perhaps this is in bad taste. Perhaps, with the reserve or inarticulateness considered proper in a country of Anglo-Saxon traditions, I should wait until the object of my acknowledgments is dead. But he shows no signs of disintegration, on the contrary, he is in vigorous health, and it might well turn out that when he is dead I shall be in the same state, which would interfere seriously with my eulogizing. So I speak my piece now.

### Resurrection

AMONG the oral and written comments which we have received on points of ancient history taken up in the "Memoirs of a Radio Engineer" series, is one from Mr. James M. Baskerville of Patchogue, Long Island. He deposes and says:

I installed and operated the Plaza Hotel station, call letters FS (not P) after Mr. Fred Sterry,

Manager. Harry Shoemaker designed the "Ice Box" for the spark gap, to reduce the complaint of patrons who desired to sleep nights. Some day I'd like to tell you how I fought it out with the *Lusitania* (incoming) and Sea Gate, from FS, before there were any laws governing good wireless conduct. No doubt the Plaza station, aggressively manned, was the air boss around New York, though frequently the Waldorf Astoria (WA) station disputed this fact with FS.

It is a good thing that Mr. Baskerville added that last qualifying statement, or Jack Pickerill would be coming out to Patchogue with an elephant rifle. The boys have never got over those days. There were no church services on the air in 1908.

### The Lingo of Radio

#### Artificial Terms and Trade Names

A NEW thing requires a new name, and when a good word does not happen to be at hand, an attempt is sometimes made to build one out of Greek or Latin roots. "Heterodyne" is an example. "Hetero" is from a Greek prefix meaning "other" or "different," as in "heterodox," "heterogeneous." "Dyne" means "force"; in physics the "dyne" is in fact the unit of force. The name was applied to the reception of a radio oscillation by causing it to beat with a local oscillation of somewhat different frequency—the local oscillation being the "other" or "different" force. Similarly with such terms as "homodyne," "autodyne," etc. With the exception of "heterodyne" and a few others, such terms do not usually attain a great vogue; their artificiality appears to be against them. For example, "diode" for a two-electrode tube, and "triode" for a three-electrode bulb, have not come into very wide use, logically constructed as they are.

Trade names are sometimes built up in the same way and frequently gain currency. For example, "Audion," "Pliotron," "Kenotron," "Radiotron," "Radiola." Sometimes words with this origin push out of use the more general names of academic origin. "Graphophone" and "gramophone" are correct synonyms for "phonograph," but they are certainly less widely known and used than "victrola," although "victrola" has no dictionary standing at all. With a generous advertiser behind it, a word may go a long way.

#### Misnomers: Inappropriate Terms, Etc.

"Static" is an ambiguous term as generally used. Its derivation is from "static electricity" in the sense of a bound charge on some insulated object, as distinguished from the electricity in motion of an electric current. The charge on a piece of sealing wax or a Leyden jar or a metal ball on an insulating stand was called "static" appropriately enough. In radio the word came to be used indiscriminately to denote the various disturbances picked up by receivers affected by lightning storms. These are highly dynamic effects, and it is glaringly inappropriate to speak of them as "static." The 1922 report of the Committee on Standardization of the Institute of Radio Engineers limits "static" to "conduction or charging current in the antenna system resulting from physical contact between the antenna and charged bodies or masses of gas." The term "strays" is applied to irregular electromagnetic waves or impulses originating from lightning or other sudden electrical changes, whether natural or artificial.

One word that has fallen into deserved disrepute is "undamped" for "continuous wave." We might as well speak of a girl as "unplain" when we want to say she is pretty.

(To be continued)



"JACK PICKERILL WOULD BE COMING TO PATCHOGUE WITH AN ELEPHANT RIFLE"



# Taking the Complexity Out of Wavelength-Frequency Conversion

How the Term "Wavelength in Meters" First Came Into Being and Why It Should Be Discarded—Why Broadcasting Stations Are Given a Definite Frequency Separation

By HOMER S. DAVIS

**E**VER since the old broadcasting channels of 360 and 400 meters discarded nearly three years ago, the use of the expression "frequency in kilocycles," rather than "wavelength in meters," has been constantly advocated. The reason for this is that the broadcasting stations are now spaced according to frequency instead of wavelength. But, like a bad habit, the use of the term wavelength is proving a difficult one to drop.

Now light, radio, heat, and sound forms of energy, are similar in one respect; they all are transmitted by wave motion. When the quiet surface of a pond is disturbed by dropping a stone into it, waves are formed which spread out in ever-widening circles. This is a classical example of wave motion. These waves travel outward with a definite velocity, and contain energy sufficient to set in motion any small floating objects that they might pass. In applying this analogy to radio waves, consider the stone as replaced by a radio transmitting station, the floating objects by radio receivers, the water by the ether, and an idea may be had of the transmission of radio energy, except that radio waves travel forward at a much greater velocity than water waves.

Every wave has a length, which is conveniently defined as the distance from the crest of one wave to the next. This is easily observed in the case of water waves, but the alternate crests and troughs, though present, are invisible in radio and light forms, and must be measured indirectly. Each wave travels with a definite velocity, defined as the distance it moves in one second. The number of times per second that a new crest passes a fixed point is called the frequency. The relation between these three properties of length, velocity, and frequency, is that the velocity, or distance one wave travels per second, when divided by the length of each wave, gives the frequency, or number of waves per second.

The early scientists who experimented with radio phenomena, were able to demonstrate that radio waves are transmitted with the same velocity as light waves, and that the two are the same kind of waves, differing in frequency. They travel with the enormous velocity of more than 186,000 miles per second, or 300,000,000 meters (the meter being a little longer than the yard) per second. As the frequencies

of light waves are almost too great to comprehend, that of yellow light being six hundred trillion per second, it was found more convenient to classify them by their wavelengths. In view of their similarity, the same practice was adopted for radio waves, and proved entirely satisfactory in those early years, long before broadcasting stations, not to mention interference between them, were even dreamed of.

But when the old 360 and 400 meter channels became jammed, and the problem of spacing the stations over a wide range of wavelengths presented itself, it became evident, for two chief reasons, that they must be spaced on a frequency basis rather than of wavelength. The first reason was that the energy radiated by a broadcasting station consists of not only the principal, or "carrier" frequency, but other, or "side" frequencies, differing from the carrier by amounts equal to the audio frequencies. Since the useful audio frequencies range up to about 5000 or more cycles per second, the energy radiated by the station is distributed from at least 5000 cycles below to 5000 cycles above the carrier frequency, a band of 10,000 cycles. To prevent overlapping, it is evident that adjacent stations should not use frequencies closer together than 10,000 cycles per second. The second reason was that if two stations use frequencies very close together, an audible "beat note" or whistle will be produced, its pitch being equal to the difference in the frequencies of the two stations. As this difference is increased, the pitch of the whistle increases until it can no longer be heard by the human ear; this occurs at a minimum of about 10,000 cycles per second.

Thus broadcasting stations are now allotted frequencies differing by 10 kilocycles (or 10,000 cycles, "kilo" meaning thousand), and although many stations use the same frequency in common, they are located in sufficiently remote parts of the country as to cause a minimum of interference.

## HOW TO USE THE CHART

**T**HE present time marks a period of transition from the old custom of speaking of wavelengths to the new one of frequencies. It is a rather trying period, for the old custom has not yet been fully abandoned, and both are in general use, resulting in a great deal of confusion. To assist the reader in converting meters into

kilocycles, until the time when the term wavelength is put back on the shelf of the scientific library whence it was first borrowed, the chart on the next page has been prepared for reference use. On the right is a scale of wavelengths from 10 to 10,000 meters, placed alongside a scale of corresponding frequencies in kilocycles. To use, merely read the desired frequency opposite the wavelength in question. For example 200 meters corresponds to 1500 kilocycles, 300 meters to 1000 kilocycles, 1000 meters to 300 kilocycles, 5000 meters to 60 kilocycles, and so on. It may be seen from the chart that the frequencies are closer together at the shorter wavelengths than at the longer ones; to take a specific case, the hundred meters between 100 and 200 correspond to a frequency range of 1500 kilocycles, or 150 station channels, whereas the hundred meters between 500 and 600 comprise a range of only 100 kilocycles, or only 10 channels. Everyone who has used the old style circular plate condenser is familiar with this crowding of stations at the shorter wavelengths.

On the left is a pair of similar scales covering a more limited range; namely, the broadcast band. It is used in the same manner as the other pair of scales; for example, station KDKA uses a wavelength of 309.1 meters, which is seen from the chart to equal a frequency of 970 kilocycles. Here the frequency scale has been spaced uniformly, suggesting the spacing of dial readings when a straight line frequency condenser is used. This clearly shows how a properly designed condenser of this type spreads out the short wavelength, or high frequency, stations, relieving the critical tuning formerly required at the low readings. (This function should not be mistaken for selectivity.)

That the adoption of this custom of speaking of frequencies is fully justified may be seen by summing up its advantages; it is in keeping with the station assignments made by the United States Department of Commerce; it replaces clumsy wavelength numbers, such as 483.6 meters, with useful frequency values, such as 620 kilocycles; it gives a direct indication of the possibility of interference between stations; it is especially convenient when straight line frequency tuning condensers are used; and its general use aids the movement toward simplifying our every-day terminology.

# WAVELENGTH FREQUENCY CONVERSION CHART

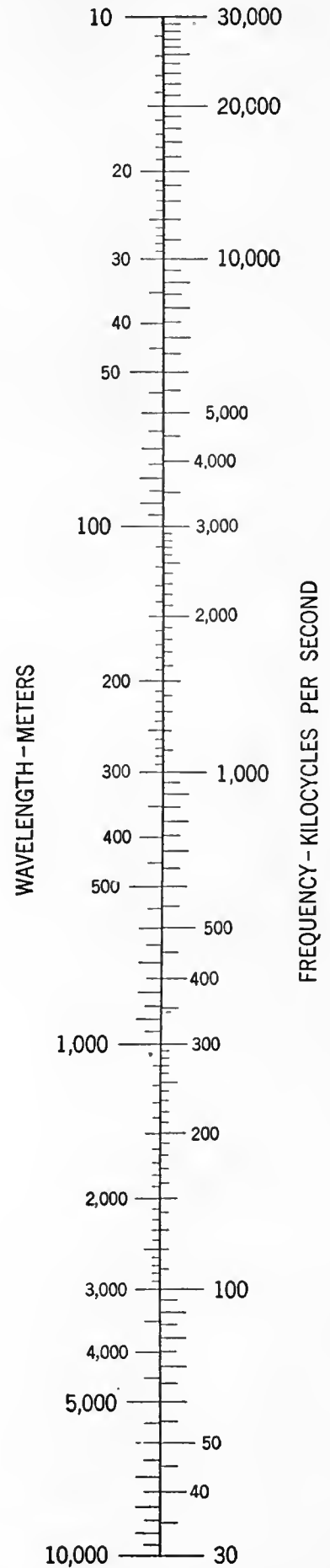
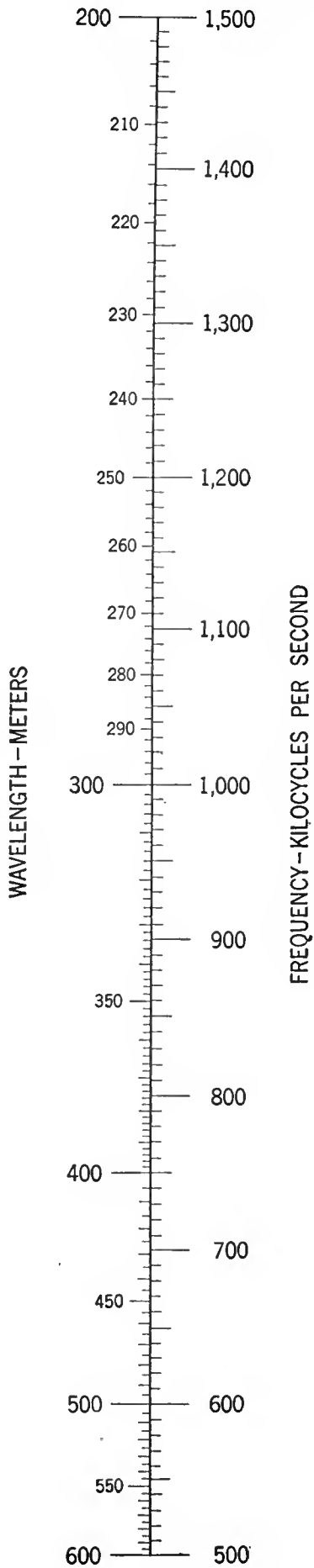

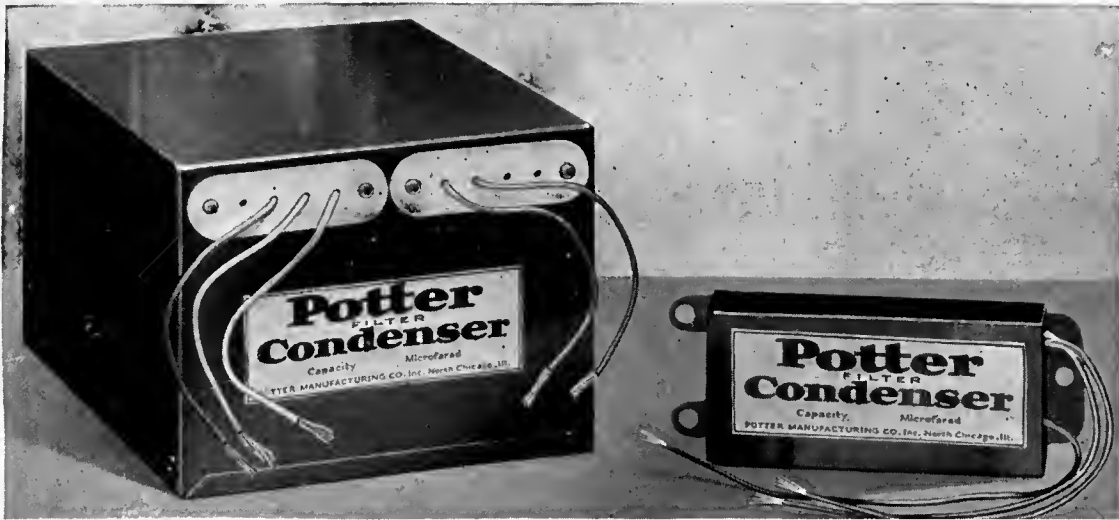

*Tested and approved by the manufacturers of the Raytheon tube for use in the Raytheon "B" Eliminator*

# The Only Condensers *especially* designed for the Raytheon "B" Eliminator

*Complete in two groups — Tested 1000 Volts D. C.*

The two Potter Condenser Groups shown above constitute a complete condenser equipment for building the Raytheon "B" Eliminator. They are the only condensers specially designed in groups for this use. They are specially developed to stand up under the high voltages used with the Raytheon tube.

Each unit in these groups has been thoroughly tested to a break-down voltage of not less than 1000 Volts D. C. They are of full capacity. They remove every vestige of A. C. impulses. They eliminate all hum. Being far more highly insulated than ordinary condensers, they will give continuous discharge service without leakage. They insure highest

possible resistance and longest life under continuous use.

The larger of the two groups shown is the Filter Unit, tapped for 8, 2, 2, and .5 Mfds. This unit is also made with smaller capacities as listed below. The smaller unit shown is the Transformer Condenser Unit, used across the secondary of the transformer. Both units have strong metal jackets. They occupy minimum space and make for quick assembly.

These two units provide a complete and ideal condenser equipment for the Raytheon "B" Eliminator, yet cost practically no more than would the cheapest condensers if bought separately. Ask for them at your dealer's today. If he cannot supply you write direct to us.

- No. 350 Raytheon Filter Unit—Tested 1000 Volts D. C.—Tapped 8 Mfds., 2 Mfds., 2 Mfds. and .5 Mfd. . . . . \$12.00
- No. 375 Same as 350, but tapped 6 Mfds., 2 Mfds., 2 Mfds. and .5 Mfd. . . . . 11.00
- No. 385 Transformer Condenser Unit—Tested 1000 Volts D. C. . . . . 1.50

## ★ **Potter** FILTER **Condensers** (An American-Made Product)

POTTER MANUFACTURING COMPANY . NORTH CHICAGO, ILLINOIS



# TONE

Full, sweet, mellow and natural, without the slightest indication of distortion, is another achievement that is making the APEX SUPER FIVE the most popular of all receiving sets.

# VOLUME

That supplies dance music or entertainment without any loss, is a feature for which the APEX SUPER FIVE is world famed.

# DISTANCE

Lends added enjoyment to radio with an indescribable fascination of tuning-in far away stations, which is always possible with the APEX SUPER FIVE.

Ask your dealer for a demonstration. Your eyes and your ears will tell you that APEX stands at the high point of perfection in both performance and appearance. \$80 without accessories.



# SUPER 5

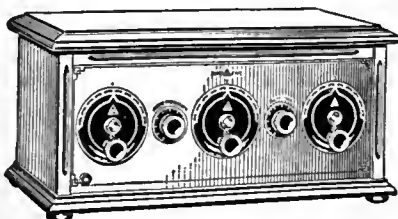

**APEX ELECTRIC MFG. CO.**

1410 W. 59th Street  
Dept. 204  
CHICAGO

# THE GRID

A Department Devoted to Solving the Problems of our Readers

## QUERIES ANSWERED

1. WHAT IS MEANT BY "TUNING"?  
F. B. F.—Topeka, Kansas.
2. THE CONTROL OF REGENERATION IN MY RECEIVER IS NOT SATISFACTORY. WHAT CAN I DO TO IMPROVE IT?  
E. W. P.—Chicago, Illinois.
3. IS THE USE OF AN OUTPUT TRANSFORMER, FOR A LOUD SPEAKER, OF ANY BENEFIT IN OBTAINING GOOD QUALITY SIGNALS?  
A. C. B.—Gloucester, Massachusetts.
4. HOW IS A C BATTERY USED IN A DETECTOR CIRCUIT TO OBTAIN RECTIFICATION?  
T. C.—Newark, New Jersey.

### AN EXPLANATION OF TUNING

IN A circuit consisting of inductance and capacity (coil and condenser), it is possible to alter the value in meters of this circuit by variations in value of either the inductance or capacity.

If a generator of an alternating current is connected with a coil and a variable condenser,

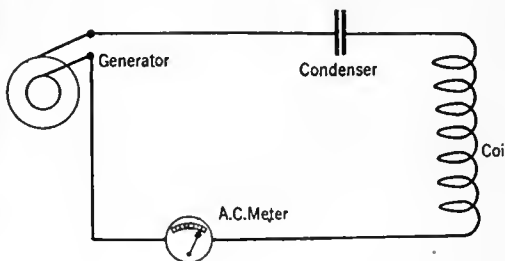

FIG. 1

then by varying this condenser it is possible, by noting the maximum deflection of a meter which is in the circuit, as in Fig. 1, to arrive at a setting of the condenser where the coil-condenser part of the circuit will be resonant with the frequency of the current set up by the generator.

We now have a new term "resonant" or "resonance," and as defined by Hogan this means "Agreement or harmony in frequency: the condition under which the natural frequency of an oscillating circuit equals the frequency of an applied alternating electromotive force."

In the circuit A, Fig. 2, we have a frequency generator whose frequency can be varied by the variable condenser C1.

Now, to bring the circuit B in "resonance," or "tuned" to A, it is necessary to rotate the condenser C2 until maximum deflection is noted on the meter. Any change in the adjustment of the frequency of the generator will necessitate an adjustment for the circuit B.

Now suppose, instead of the generator circuit A, a signal from a broadcasting station is substituted. Since broadcasting stations are as-

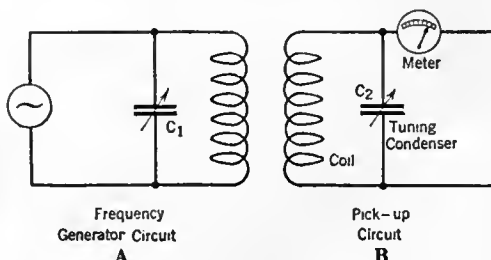

FIG. 2

signed to a definite frequency (wavelength), then it is possible to adjust the circuit B, or "tune it," by means of the condenser C2, until it is in resonance with the transmitted wave. To

change over to another station transmitting at a different frequency (wavelength) it is only necessary to re-adjust the receiving condenser C2 until the circuit is in resonance with the new signal.

As was previously stated, variation in value of a circuit may also be obtained by varying the inductance value of the coil. This may be done by a switch tap arrangement as in Fig. 3A, or by the variometer method in B. The switch-taps allow the use of more or less of the coil turns which, at its best is only a rough control. In the variometer arrangement, the total inductance value is governed by the coupling of the fields of the two parts of the coil. They are wound so that when at right angles to each other the fields oppose each other and the inductance value is low. When parallel,

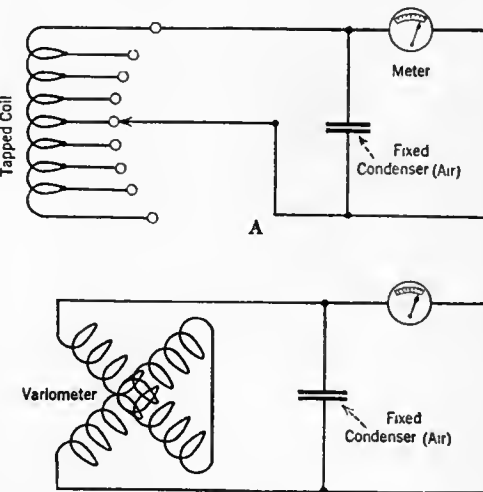

FIG. 3

the fields aid each other and the inductance value is high.

### HOW TO OBTAIN BETTER REGENERATION

WHEN a receiver of the regenerative type goes into oscillation with a "plop" instead of gradually doing so, as the tickler coupling is increased, it is impossible to tune-in distant stations satisfactorily and steps should be taken to rectify this condition.

Often smoother oscillation can be obtained by decreasing the B battery voltage applied to the detector tube plate, but when this does not alter conditions, it is then necessary to employ other means for obtaining the desired results.

If the tickler coil produces regeneration, then by reducing the number of turns on this coil, one at a time, a point may be reached where, upon advancing the tickler, there is an even, smooth, production of oscillation.

# POWELL CROSLLEY

## JR.

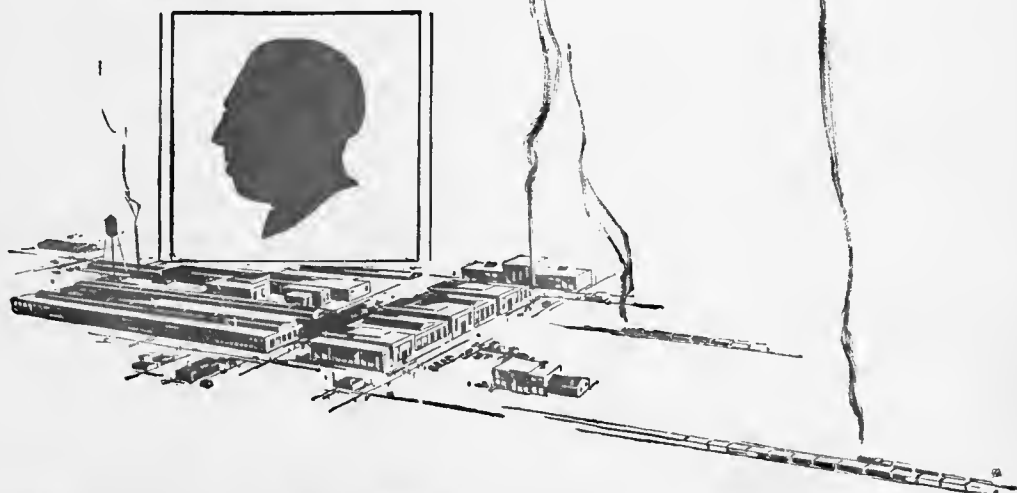

## INDUSTRIALIST *Pioneer Radio Builder*

At a time when products of his manufacturing genius were already known to millions, Powell Crosley, Jr., boldly diverted his energies to the development of radio reception, then scarcely known beyond the laboratory walls.

Pioneering both in engineering trends and manufacturing practices, Mr. Crosley has been a vital factor in making radio and broadcasting as much a part of American life as motion pictures and the motor car.

There is scarcely a milestone in the development of popular radio on which his shadow has not been the first to fall. And his announcement of December 26th concerned a milestone that dwarfed all others in its importance—*four entirely new radio receiving sets:*

The Crosley 4-29 (4-tube)	. . .	\$29.00
The Crosley 5-38 (5-tube)	. . .	38.00
The Crosley R. F. L.-60 (5-tube)	. . .	60.00
The Crosley R. F. L.-75 (5-tube)	. . .	75.00



These are now being demonstrated by Crosley dealers and will be completely described in a forthcoming issue.



135-C is furnished with leads and phone tips for plugging into Radiola Models 20, 25, 26 and 28..... **\$10.00**

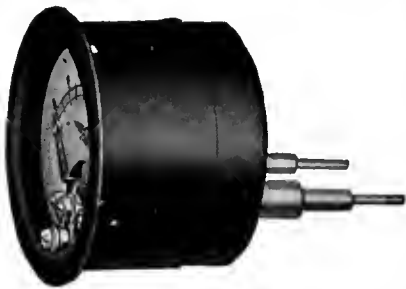

135-A has prods for plugging into Radiola Models 25 and 28..... **\$7.50**



**\$12.50**

107 Junior Tube-Checker makes the testing of tubes in the home easy.

**NEW**

Write for copies of Circulars 735 and 739 describing these three new Jewell Radio Instruments for Set owners.

★ **ORDER FROM DEALER**

**JEWELL ELECTRICAL INSTRUMENT CO.**

1650 WALNUT ST. CHICAGO

26 years making Good Instruments

Variometers which are employed to produce regeneration, should be so placed that no permanent coupling effects between them and other coils used in the receiver are obtained.

Replacing the small by-pass condenser which shunts the primary of an audio frequency transformer, will often improve matters. A too high value of grid leak sometime causes this inefficient condition while even the grid condenser's value may be improved upon.

**PROTECTING THE LOUD SPEAKER**

**W**HEN a power amplifier is used in a receiver, it is well to consider just what is taking place in the loud speaker. Unless the action is visualized and understood, the user cannot hope to obtain maximum efficiency from his apparatus.

Most of the loud speakers on the market are merely elaborations of head phones, so constructed that a large diaphragm is actuated by the impulses surging through the magnet windings of the loud speaker reproducer unit. Also the majority employ a type of mechanism where the armature, pin, or diaphragm, is pulled toward the pole pieces of the magnet by the strong magnetic field set up by the permanent magnet.

Now, when signals are received and passed along through the vacuum tubes in the form of impulses, the diaphragm is alternately released and gripped as the impulses first neutralize then aid in the gripping of the diaphragm. While such a system is satisfactory, where normal B battery voltage is employed, it is not at all to be desired in cases where high B potential is applied to the plate of the last audio tube.

The reason here is that the heavy current coursing through the windings of the loud speaker tends to paralyze the diaphragm, thereby causing imperfect reproduction.

Now, if some arrangement could allow the diaphragm more freedom of action, then the objection to the use of high B battery potential would automatically become void.

Such a device is simple to construct and efficient in operation.

It consists of a large fixed condenser, of 1 mfd. capacity, and an iron-core coil with high impedance and low resistance. One having an inductance value of 350 henries is highly satisfactory.

The parts are connected in the circuit as shown

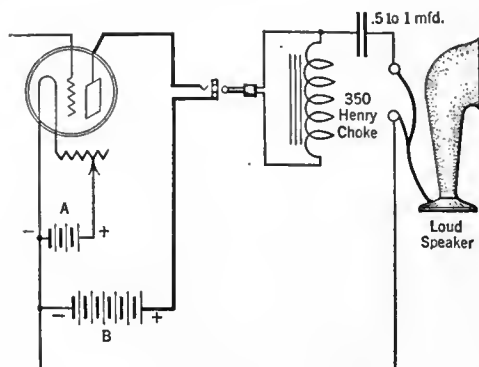

FIG. 4

in Fig. 4. Three wires, instead of the conventional two from the loud speaker, lead to the set. The lower side of the speaker connects to the minus side of the filament, while the impedance

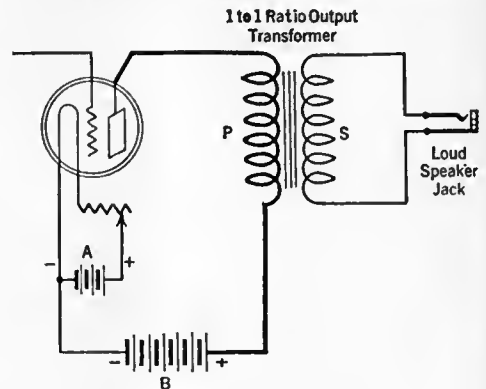

FIG. 5

coil connects one side to the plate of the last tube, the other side to the high voltage terminal of the B batteries. The upper side of the loud speaker connects to the large fixed condenser, the other side of which terminates at the plate lead of the impedance coil.

A glance at the circuit will show that now the heavy B battery potential is circuited through the choke coil instead of through the loud speaker windings. The variations in the electro-magnetic field set up in the choke coil, cause a charging of the large condenser which in turn produces an a.c. signal in the loud speaker.

Another type of unit which will do much the

same thing is an output transformer. It will be recalled that such a transformer is employed in push-pull amplifiers, with the exception that the primary has a middle tap. Where the output transformer is used in a single stage power amplifier, the primary and secondary each have two terminals. The ratio of the windings is 1:1. A circuit diagram is shown in Fig. 5.

**C BATTERIES IN THE DETECTOR CIRCUIT**

**L**ATELY the C battery has come in for its bit of attention because of its use as a satisfactory substitute for the usual grid leak and condenser in obtaining rectification in a tube detector circuit.

The use of a C battery as a grid bias in amplifiers, has been an accepted practice for years, but little has been generally known about its function in a rectifying circuit.

The Model 1926 receiver, described by McMurdo Silver in the November, 1925, RADIO BROADCAST, employed this system of detection very successfully.

Those who have had the opportunity to compare this and the old grid leak and condenser system have, no doubt, noticed that while the former produces a healthier signal, the latter is more to be desired where sensitivity and selectivity are the prime considerations.

In this system the tube is acting as a distorting amplifier, and the C battery is the agent which produces the distortion because it shifts the

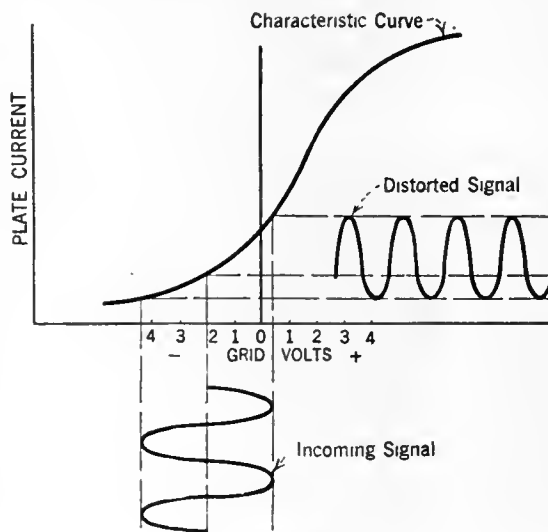

FIG. 6



# The Eveready Hour



LIKE the fabled ship in which Jason brought home the enchanted fleece of gold, the Eveready Hour brings a rich treasure of entertainment to charm the harbor-homes of its hearers.

Inaugurated two years ago, the Eveready Hour was an adventure in broadcasting—an hour of connected entertainment, uninterrupted by the frequent injection of the name of the broadcaster.

Many of these programs have become famous. Thousands of letters voice the appreciation of our audience and ask for repetition of favorites. We make no requests for these letters, but they mean much to our artists and to us, and are of great value in helping us in

our efforts to arrange programs of a distinctive nature and pleasing to the vast audience.

Radio has already become a highly specialized art worthy of the most scrupulous code of ethics, and the Eveready Hour represents a sincere effort to pioneer in providing the most acceptable form of radio entertainment.

Tuesday night means Eveready Hour  
—9 p.m., Eastern Standard Time,  
through the following stations—

WEAF—New York	WSAI—Cincinnati
WJAR—Providence	WWJ—Detroit
WEEI—Boston	WOC—Davenport
WTAG—Worcester	WEAR—Cleveland
WFI—Philadelphia	WCCO—Minneapolis
WGR—Buffalo	WGN—St. Paul
WCAE—Pittsburgh	WGN—Chicago
	KSD—St. Louis

**EVEREADY**  
**Radio Batteries**  
—they last longer

Eveready programs cover a wide range of entertainment and human interest, transporting us to periods of wholesome simplicity; to barren islands where marooned sailors meet adventure, starvation and death; to battle-scarred France with singing doughboys; to emotional heights by telling with music the stories of the seasons; and to memories of yesteryear aroused by old ballad and musical comedy favorites.

Eveready Hour begins at 9 p. m. each Tuesday night, Eastern Standard Time.

NATIONAL CARBON CO., INC.  
New York San Francisco

Canadian National Carbon Co., Limited  
Toronto, Ontario



He was amazed—  
he had been sure  
it was static—

**M**ANY fans are blaming static for noises which are not static at all. They are noises which can be eliminated. For example, unless you keep your contacts between tube and sockets clean at all times, corrosion is going to cause disturbing noises which you may lay to static.

It is easy to keep these contacts clean with the Na-Ald No. 400 De Luxe Socket. Just a turn or two of the tube in the socket cuts away all corrosion from tube terminals and clears up the voice of your radio instantly. No need to take the tube out and sandpaper each terminal with this socket. When the tube is turned in the socket, the exclusive side-scraping duo-contacts scrape away all corrosion and the terminals come to rest on the scraped portions. The Na-Ald No. 400 De Luxe Socket is the only socket that eliminates noises due to corrosion. Meter tests have proved this action sure and positive.

And our No. 400-S socket (the regular No. 400 on spring mount) also eliminates microphonic noises due to vibrations.

Both the No. 400 and the 400-S sockets are made of Alden-processed Bakelite which conserves all the current energy. Laboratory tests proved Na-Ald Sockets most efficient in low loss and low capacity. Na-Ald Socket No. 400 was selected by ten famous radio engineers as best for the famous Hammarlund-Roberts set. It is part No. 6. List prices: No. 400 and No. 400-S, 75c.

The New socket that takes all the new tubes

THE new Na-Ald Socket No. 481-X takes all the new tubes without adapters. Sure, Positive Contact. Alden Processed Bakelite for lowest losses. List price, 481-X, 35c.

★ Write for full information on the complete line of Na-Ald Sockets, Dials and Adapters.

ALDEN MANUFACTURING COMPANY

Dept. B-15 Springfield, Mass.

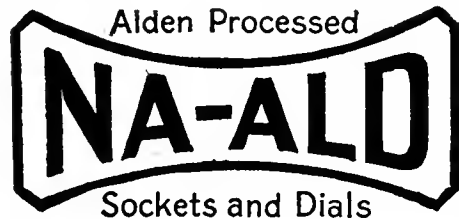

operating point on the characteristic curve of the tube to the curved portion. See Fig. 6. Here one half cycle of the incoming signal is reproduced, greater in proportion to its other half. This is because that section of the curve below

In A, practically the same circuit is shown as that in B, but the C battery is shunted with a potentiometer of 200 or 400 ohms. By means of this potentiometer, it is possible to apply a readily regulated C voltage ranging from

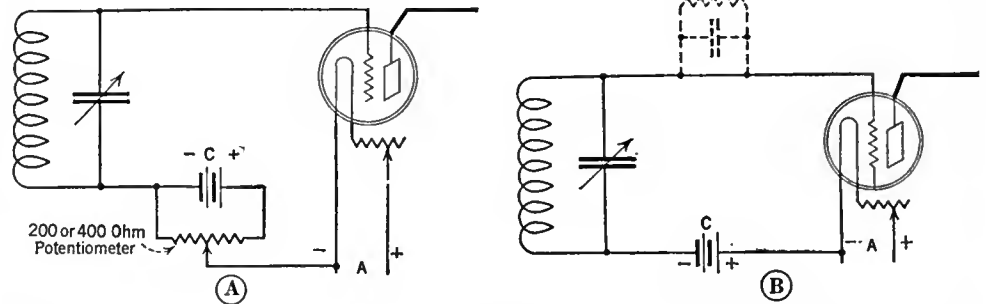

FIG. 7

Showing the position for a C battery in a detector tube circuit. In A, the grid battery is shunted with a potentiometer to control the voltage bias. A potentiometer is not essential, as B shows

the mid horizontal line of the distorted wave form, flattens out more than the part above it.

In Fig. 7B, the C battery is shown connected in a detector circuit, replacing the more standard grid leak and condenser. Note the polarity of the C and A battery leads.

0 to 4½ volts, or whatever the full value of the C battery may be. Such an arrangement aids in shifting the working point of the tube to that position where most satisfactory distortion-detection is to be obtained. With only the C battery, as in B, the variation is mainly in steps of 1½ volts.

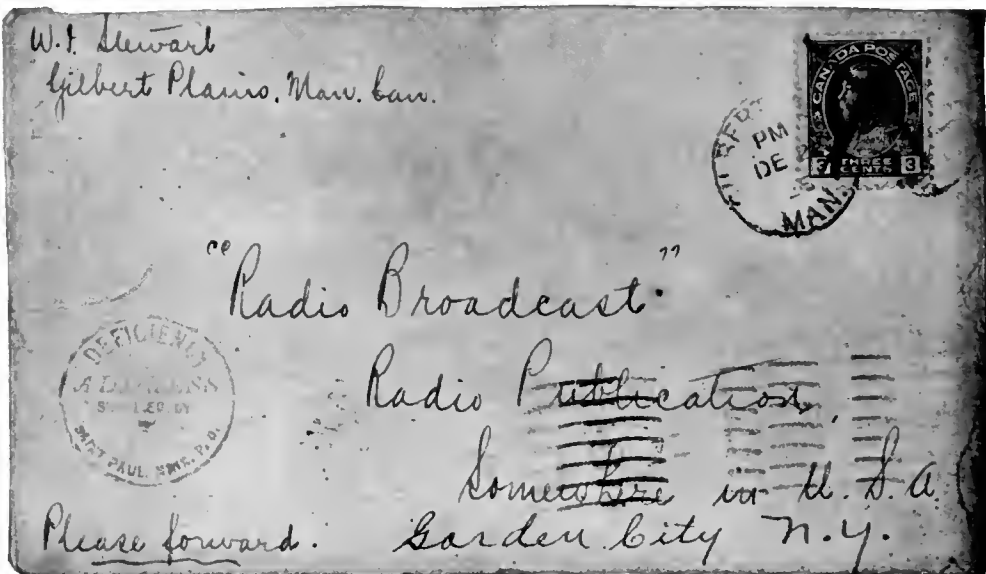

DON'T ADDRESS YOUR GRID DEPARTMENT LETTERS LIKE THIS  
Originating in Manitoba, Canada, this letter was forwarded by the postal authorities to St. Paul, Minnesota, and there was re-addressed to Garden City as shown

**GRID INQUIRY BLANK**

Editor, The Grid  
RADIO BROADCAST  
Garden City, New York

DEAR SIR:

I am a subscriber to RADIO BROADCAST and therefore will receive answers to my queries free of charge.

I am not a subscriber and enclose \$1 to cover cost of answers.

NAME .....

ADDRESS .....

G. F.

WHEN WRITING TO THE GRID—

A TYPEWRITTEN letter, written on one side of the paper only, is to be preferred, as it aids in the quick formation of a satisfactory reply.

Don't fail to send a stamped addressed envelope with your inquiry.

Don't send a second inquiry about the first.

Don't include questions on subscription orders or inquiries for other departments of Doubleday, Page & Company.

In asking questions give us all the information that will aid in advising you. If the question relates to apparatus described in RADIO BROADCAST, give the issue, page number, and figure number of the circuit diagram, etc.

Be explicit yet brief.



FANSTEEL  
**Balkite**  
*Radio Power Units*

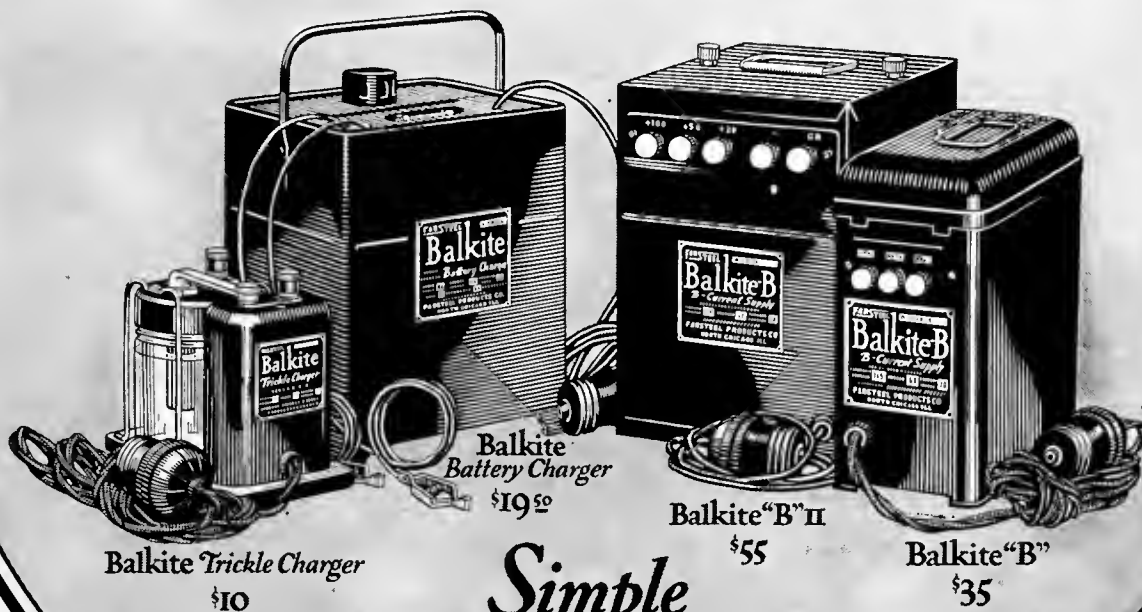

*Simple  
 Entirely Noiseless  
 Permanent*

*Manufactured by FANSTEEL PRODUCTS COMPANY, Inc., North Chicago, Illinois*

**Convert your present receiver into  
 A LIGHT SOCKET SET  
 with  
 Balkite Radio Power Units**

—+—  
*Ask your Radio Dealer*  
 —+—

Manufactured by FANSTEEL PRODUCTS COMPANY, Inc., North Chicago, Illinois  
 Sole Licensees in the United Kingdom:  
 Messrs Radio Accessories Ltd., 9-13 Hythe Rd., Wellesden, London, N.W. 10



## TONE

Full, sweet, mellow and natural, without the slightest indication of distortion, is another achievement that is making the APEX SUPER FIVE the most popular of all receiving sets.

## VOLUME

That supplies dance music or entertainment without any loss, is a feature for which the APEX SUPER FIVE is world famed.

## DISTANCE

Lends added enjoyment to radio with an indescribable fascination of tuning-in far away stations, which is always possible with the APEX SUPER FIVE.

Ask your dealer for a demonstration. Your eyes and your ears will tell you that APEX stands at the high point of perfection in both performance and appearance. \$80 without accessories.



## SUPER 5

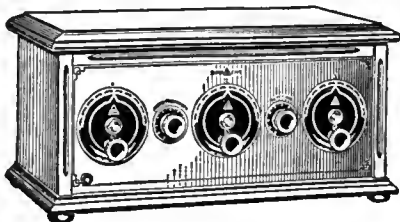

**APEX ELECTRIC  
MFG. CO.**

1410 W. 59th Street  
Dept. 204  
CHICAGO

# "NOW, I HAVE FOUND . . ."

A Department for the Exchange of Ideas and Suggestions of Value to the Radio Constructor and Operator

**C**ONTRIBUTIONS to this department are welcome and those used will be paid for at the usual rates, that is, from two to ten dollars each. A prize of twenty-five dollars is given for the best idea used during each three-month period. The prizewinner for the last period is Mr. J. T. Garver, of Huntington, Tennessee, whose description of a home-made loud speaker appeared in the last (January) RADIO BROADCAST. Manuscripts should not exceed about three hundred words in length, and should be typewritten. Little consideration can be given to manuscripts not typewritten. Envelopes should be addressed to this department, RADIO BROADCAST, Garden City, New York.

### USING A VOLTMETER AS A MILLIAMMETER

**I**N LOOKING for trouble in a receiving set, it is often convenient to connect a milliammeter in the negative B battery lead. Thus, as each tube is plugged in or turned on, the change in plate current, and thus the current drawn by this tube, may be readily observed. A tube that is worn out will draw very little plate current. If there is an open plate circuit (caused by a burned-out transformer, loud speaker or defective jack, etc.) it will be readily detected as there will be no increase in the milliammeter reading when the tube with the open plate circuit is turned-on.

If a milliammeter is not available for this use, a voltmeter may be employed as a substitute. The deflection of a good voltmeter is directly proportional to the current passing through it. The current required for full-scale deflection may generally be obtained from the manufacturer of the meter.

For example, a Weston 301 eight-volt meter has a full scale deflection of 16.12 milliamperes, and there are 40 divisions on the scale. As the reading is in proportion to current, the reading in scale divisions multiplied by 16.12 and the quotient divided by 40, gives exactly the current passing through the meter in milliamperes. For this particular meter it figures number of divisions times .4 approximately. Thus a reading of six scale divisions would indicate  $6 \times .4$ , or 2.4 milliamperes plate current.

CLAUDE SCHUDER,  
Sumner, Illinois

### COIL DESIGN DATA

**I**T HAS been generally acknowledged in radio circles that d.c.c. wire is very satisfactory for radio purposes, and most designers, accordingly, specify this type of wire in the construction of their coils.

The main reason for this preference seems to lie in the fact that the comparative thickness of double cotton insulation is instrumental in producing low distributed capacity, which is, as is well known, a very desirable quality.

The majority of the present day variable condensers with air dielectric, possess exceedingly high maximum to minimum capacity ratios, and naturally, very low minimum capacity values. Such condensers, coupled with really efficient radio coils of low distributed capacity, tend to extend the lower limit of our wavelength range, thus permitting us to tune-in more of the low power, high frequency, Class A, broadcasting stations.

Unfortunately, a coil made of double cotton covered wire is quite inefficient in moist weather because cotton is highly hygroscopic, which means that it will absorb moisture from the air. Not only is the efficiency of such a coil variable, but it is often variable to such an extent as to make long distance reception in moist weather practically impossible.

To eliminate the undesirable hygroscopic characteristic of d.c.c. coils, it has been suggested that such coils be painted with a light coat of thin shellac. True enough; such precautions protect the coil from moisture without adding greatly to its distributed capacity. However, even this increase in distributed capacity, when added to other losses inherent in construction of the coil, causes diminished efficiency and a shorter radius of reception.

It is for this reason the writer suggests that celluloid cement be substituted for shellac in coating d.c.c. coils. Celluloid cement will:—

1. Add less than shellac to the distributed capacity of the coil.
2. Decrease dielectric losses by making the coils self supporting, as the winding form may be removed when the cement dries.

*Note:* When such a coil is removed from



### A PRIZE-WINNING IDEA

The home made loud speaker described by Mr. J. T. Garver in this department of the January RADIO BROADCAST, was awarded the quarterly \$25 prize offered by this magazine for the best contribution published in the "Now, I Have Found . . ." Section. Complete constructional data on the construction of the speaker appeared in the January number. The winner of the next prize, that offered for the February, March, and April period, will be announced in the May RADIO BROADCAST. All manuscripts for this department should be prepared and sent according to the conditions given at the top of this page. Special consideration is given to typewritten manuscript.

# ATWATER KENT RADIO



## Fifteen acres of radio

*What does it mean to you?*



Radio Speaker  
Model H, \$22



Model 20 Compact,  
\$80

Prices slightly higher  
from the Rockies west,  
and in Canada.

### Every Sunday Evening

The Atwater Kent Radio Hour brings you the stars of opera and concert in Radio's finest program. Hear it at 9:15 Eastern Time, 8:15 Central Time, through:

- WEAF . . . . . New York
- WJAR . . . . . Providence
- WERI . . . . . Boston
- WCAP . . . . . Washington
- WSAI . . . . . Cincinnati
- WCCO . . . . . Minn.-St. Paul
- WFI } . . . . . Philadelphia
- WOO } alternating
- WCAE . . . . . Pittsburgh
- WGR . . . . . Buffalo
- WOC . . . . . Davenport
- WTAG . . . . . Worcester
- KSD . . . . . St. Louis
- WWJ . . . . . Detroit
- WEAR . . . . . Cleveland
- WLIB . . . . . Chicago

**L**OOK at this building. It is the factory where Atwater Kent Receiving Sets and Radio Speakers are made.

To every dealer this picture tells a story of Stability.

Already the largest radio factory in the world, our plant is still growing. The demand for Atwater Kent Radio has proved that we didn't have room enough.

By May, a three-and-one-half acre addition will be completed. The main building will then cover nearly fifteen acres.

If this isn't enough, we shall go on building, for we have the ground.

Think of it! Fifteen acres of radio — and every part of every Receiving Set and Radio Speaker made from our own designs by our workers in our own way. And every set and speaker constructed with as much

care as if this were the smallest factory in the world and we had a reputation yet to win.

Thus we prove our confidence in Radio now and in Radio five, ten, twenty years from now — indefinitely.

Look at this picture again and let it remind you that

1. A sound product, rightly designed, carefully manufactured, and sold at a sensible price made possible by large production and modern methods, has become so popular that it takes a fifteen acre plant to meet today's demand.
2. The Atwater Kent Manufacturing Company has invested its money in this plant because it is in the radio business to stay.

Is not this something to think about?

*Write for illustrated booklet telling the complete story of Atwater Kent Radio*

**ATWATER KENT MFG. CO.**  
A. Atwater Kent, President  
4726 WISSAHICKON AVE. PHILADELPHIA

# The Loud Speaker Sensation!



## The KODEL MICROPHONE LOUD SPEAKER

You can't tell the KODEL MICROPHONE LOUD SPEAKER from the microphone the broadcasting stations use—they are exactly alike in size and appearance.

The efficient Kodel Sound Unit, with an ingenious new anail-shell horn, mounted inside the microphone case, produces a remarkably clear, full-toned volume. Non-vibrating tone chamber absolutely eliminates distortion.

\$15 model incorporates Kodel, Jr. unit equipped with large Kodel unit \$20

**\$15.00**

Radio dealers everywhere have them. ★

THE KODEL RADIO CORP.  
505 E. Pearl St. Cincinnati, O.

RECEIVERS :: SPEAKERS  
HOMCHARGERS

**WKRC**

Owners of Kodel Broadcasting Station WKRC. Send for program

### Books by Telegraph

between

New York

Cleveland

Kansas City

Springfield

Toledo

St. Louis

Doubleday, Page Book Shop

the winding form, it is necessary to paint the inside of the coil in order to render it absolutely non-hygroscopic.

Now a few words about the preparation of the celluloid cement. Obtain a wide-mouthed bottle of acetone and small pieces of celluloid, the quantity to be determined by experiment. The latter does not have to be purchased, as old photographic films can be used after the emulsion has been removed in hot water.

Into the acetone throw a quantity of celluloid, taking care that the pieces are small. Leave the bottle overnight and in the morning it will be found that the celluloid has been dissolved. The consistency of the solution should be that of a thin syrup. By adding to the solution, either more acetone or celluloid, you will obtain the right consistency.

Apply the cement with a brush, and keep the bottle well stoppered at all times, as the acetone has a tendency to evaporate and leave the cement too thick.

BORIS S. NAIMARK,  
New York City.

### A SIMPLE LONG-WAVE RECEIVER

THE radio fan who has not built himself an ultra audion set to play with when his regular equipment fails to function, just doesn't know how much fun he is missing.

The expense of a set of this sort is quite modest and its performance is certainly wonderful. The transoceanic code stations come booming in on almost any frequency band from 300 down to 20 kilocycles (1000 to 15,000 meters)—and on even longer waves. The big fellows give excellent code practice for nearly all of them send very slowly, and repeat each word.

I wish I could radiate some of the pleasure and enthusiasm I get from the little



FIG. 1

The completed ultra audion receiver. Not the slotted strip of bakelite which permits variable coupling between the two coils

ultra audion set pictured above. There must be thousands of others, who, like myself, want to get a little vacation from the broadcasting territory on those occasions when the programs just don't seem to fit one's mood. There are all sorts of strange and mysterious territories to explore where whistling treasures may be picked up. The big European stations talk with the Americans, and Panama sends up tones from the tropics.

I have built a number of ultra audion circuits, and all functioned very nicely.

But there are drawbacks; the annoying instability of the circuit for example, and the squeals and howls from body capacity. Many times I have found it essential to sit perfectly still to hold a very distant station. Finally I made a discovery. By connecting the metal case of the head phones with the ground, the set immediately settles down to steady work. I have a six-foot piece of silk-covered tinsel cord with a test clip on each end. I clip one end to the headband adjustment and the other to the ground post. It is not well to twine the cord around the phone cord but permit it to hang loosely.

Strange as it may seem, another improvement that has been decidedly satisfactory is the addition of a tickler. The illustration, Fig. 1, shows how a coil mounting

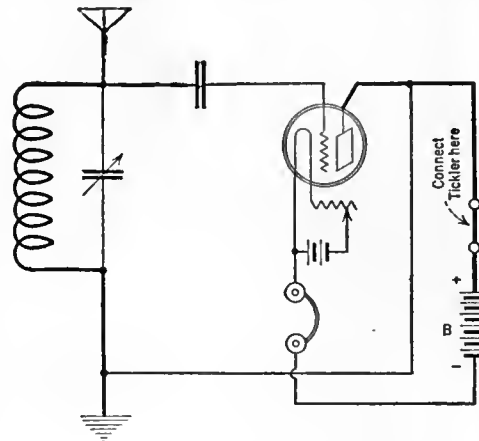

FIG. 2

The circuit diagram of the ultra audion. A tickler coil arrangement can be included as shown

is attached to a sliding strip of bakelite, and held in place with a thumb nut. This coil is inserted between the positive B binding post and the plate connection on the socket. The condenser has a capacity of .0005 mfd. Any tube may be used but I seem to get best results with a standard UV-200 or C-300 with about 22 volts on the plate. For an antenna for the transoceanic stations, with a coil of 1000 to 1500 turns, I have a stretch of about 125 feet of single copper wire, thirty feet high. The tickler for the very large coils should increase in size in proportion. For instance, with 1500 turns I seem to get best results with a 500-, or 750-turn tickler.

Other than adding the tickler and the grounding of the phone caps, the hookup is exactly the same as shown in the DeForest catalogues of seven or ten years ago. The circuit is shown in Fig. 2.

H. H. BUCKWALTER  
Denver, Colorado.

### A GOOD AUDIO AMPLIFIER

BEING convinced that the cone type of speaker does not do itself justice on the standard two-stage audio amplifier, I am giving the wiring diagram of an amplifier which in my opinion will really give the volume and true reproduction which we all strive for. See Fig. 3. Used with a three-circuit tuner and tube detector, it will furnish the most perfect quality I have yet heard.

The parts may be assembled to suit the fancy of the constructor, remembering only the standard precautions about short grid leads, transformers mounted at right angles and non-parallel leads. Although there are three stages of audio, the amplifier

Sixteen newspaper and radio publications have saved you the work of trying out various B battery eliminators—



Patented May 15, 1923

They have put their official okay on the

## TIMMONS *B-Limiter*

We would like to tell you something about the tests to which these publications subject the B-Limiters. For this purpose we have prepared a folder which we will send. All of these tests were more severe than conditions the B-Limiter will ever meet on your set.

In this folder you will also find quoted in the exact words of publications just what the tests showed.

**B-Limiters operate on 110 volts, 60 cycle alternating house current and completely eliminate all B batteries**

The Timmons Laboratories, which produced the B-Limiter, have now developed the  
*Timmons Cone Talker*

**Price, \$25.00**

**14-inch Cone**



There are years of experience in acoustics behind this new Timmons Cone Talker. However, as most of the adjectives have been exhausted in describing other loud speakers, we'll just ask you to hear the new Timmons Cone. If you wish, we'll first send you a folder telling you all about it. Your dealer handles both the Timmons B-Limiter and Timmons Cone Talker—or we'll tell you one who does.

**RMA**



**Timmons Radio Products Corporation**  
Germantown, Philadelphia, Pa.

# TIMMONS *Radio Products*

★ Tested and approved by RADIO BROADCAST ★

# STUDY RADIO!

Radio, the field of unlimited opportunity, calls for more trained men.

Prepare yourself for a high salaried position by using your spare time to study radio at home.

Radio Institute of America, the world's oldest radio school, has graduated more than 7,000 students. The value of RIA training is universally recognized—and graduates readily secure positions.

This coupon will bring you a wealth of important and interesting information.

## RADIO INSTITUTE OF AMERICA

Formerly Marconi Institute  
Established in 1909

328 Broadway  
New York City

TEAR OUT

Radio Institute of America  
328 Broadway, New York City

Please send me full information about your Home Study Course of radio instruction.

I am interested in the complete course, including code instruction, which qualifies for the U. S. Gov't Commercial or Amateur Radio License.

I am interested in the technical course for radio dealers, jobbers and salesmen.

Name .....

Address .....

will not howl or distort, and there is no necessity for grounding the transformer frames.

If the amplifier is to be used in connection with a radio frequency set, it is advisable to use either two tubes in parallel in each half of the push pull, making four tubes in the last stage, or use two power tubes, as the volume to be handled will overload two of the 201-A type tubes.

A list of material is given below, and although it is not necessary to adhere strictly to the list of manufactured parts given, it is essential to use good transformers.

- 2 Amertran transformers, ratio 5:1.
- 1 set of Western Electric or Como push-pull transformers.
- 2 Bradleystats.
- 1 single-circuit jack.
- 4 General Radio sockets.
- 1 "Turn-It" grid leaks.
- 1 2-mfd. fixed condenser.
- 2 .002-mfd. fixed condensers.
- 2 .001-mfd. fixed condensers.

Only one jack is used, as I find that better tone quality is obtained by using all the tubes and controlling the volume by the

besides. How to eliminate them, and not reduce the volume to the two-tube level was at first a problem.

Connecting a resistance across the secondary of the additional transformer efficiently eliminated the squeals and the volume also. It was found that varying direct and reversed grid biases had much the same effect.

While disconnecting one of the various unsuccessful arrangements, the dulcet tones of a local station suddenly half deafened the operator! Upon said operator's springing back in surprise, the old familiar medley of horrible sounds came back in full force. In short, placing the hand of a human ground on the grid terminal of the second transformer accomplished what nothing else had done. The trail now being clearly blazed, a variable resistance of 25,000-100,000 ohms was connected between this point and the ground.

Using this arrangement, a signal which is audible on a cone speaker with two tubes, when the ear is placed very close to the instrument, is magnified sufficiently to fill comfortably quite a large sized room. Signals from WBZ at a distance of about one

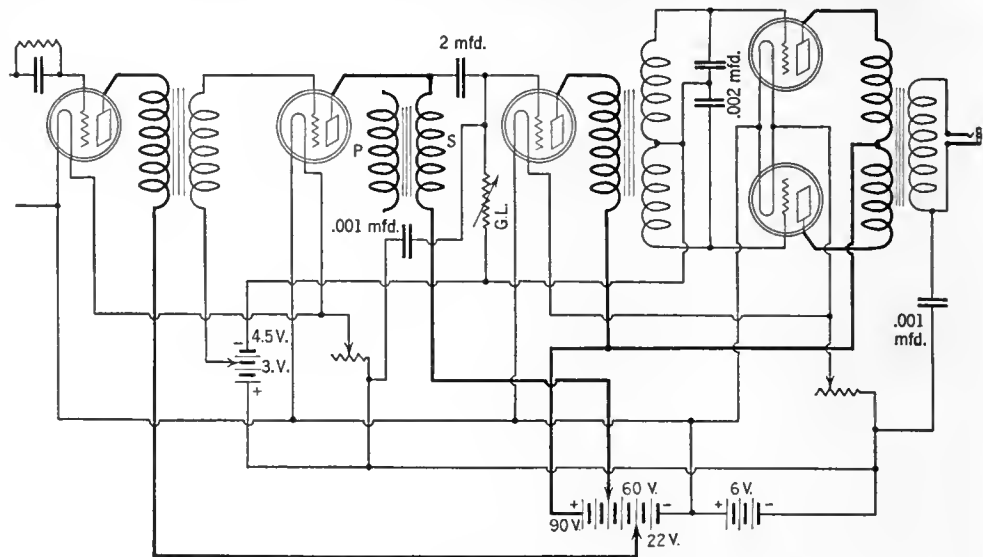

FIG. 3

The connections for the quality audio amplifier from the output of the detector tube are shown in this diagram. There are three stages of audio but four tubes are employed

regenerator, or if the set is non-regenerative, by the detector and first amplifier rheostat.

Due to the high amplification obtained, it will often be found that unless exceptional volume is desired, the tubes may be operated at four volts, thus lengthening their life and compensating for the additional tubes used. For those who do not use a voltmeter, I would suggest that the tubes be turned up to normal brilliancy while tuning-in, and then turned down as far as possible without destroying the tone quality.

EDWARD T. WERDEN  
Mount Vernon, New York.

### IMPROVING THE VOLUME OF THE TWO-TUBE ROBERTS CIRCUIT

DESIRING more volume than that obtained from the usual Knock-out two-tube set, and not wanting to change the whole arrangement of the apparatus, I added one step of orthodox transformer-coupled audio amplification. Using a G. R. Type 285 audio transformer gave enormous volume—and a thousand raucous squeals, noises, and howls

hundred miles are rather too loud for comfort in a large room.

As an important afterthought, I should like to emphasize the fact that the quality obtained—both transformers being of the type mentioned—is good enough to have caused surprised comment from a large number of people.

J. W. TEALE,  
Boston, Massachusetts.

### WINDING SPIDER WEB COILS

I HAVE found that two empty thread spools, together with a bolt of sufficient length, a nut, and washer, are of much help in quickly and accurately winding spider web coils.

The bolt is passed through one spool, then through the hole in the center of the coil form, and then through the other spool, after which the washer and nut are placed on the bolt and the nut tightened.

This gives a firm and convenient handle for holding the form during winding, greatly facilitating that process.

H. EDWARD KNIES,  
White Haven, Pennsylvania.



**\$50. to \$250 a week**  
**IN WORK THAT IS**  
**ALMOST ROMANCE**

**Be a Radio Expert**

Get into the great new Big-Pay Industry—Radio. If you're earning a penny less than \$50 a week, **clip coupon now. Send for AMAZING FREE BOOK.** Be a Radio Expert and draw down big money for the easiest and most fascinating work in the world. Positions everywhere. Thoroughly-trained men are in big demand. Need for Radio Experts in every community. Short hours. **BIG PAY. Free book gives all the facts.** Astonishing opportunities—thousands of them! Every day N. R. I. trained men are taking good places in the Radio field. Free book tells all about their success. Send for it now!



**Learn Quickly and Easily**  
**AT HOME**

Master Radio Engineers will show you how to qualify quickly and easily at home, for Radio's fine jobs. We **guarantee** to train you successfully. Lack of experience no drawback—common schooling all you need. Our tested, clear methods make it easy for you. Send coupon now for free proof.

**Instruments Given with Course**

All instruments shown here and many others given to students for practice work while learning. Receiving sets, from simplest kind to thousand mile receiver. An **UNEQUALLED OFFER.** Many other big features for limited time only.

**Famous Training That "Pays for Itself"**

Spare-time earnings are easy in Radio. Increase your income almost from the start through practical knowledge we give you. This is the famous **practical** training that **pays its own way.**

Get this Amazing Book

Most amazing book on Radio ever written—full, interesting facts about this great field and how we prepare you and help you start. You can do what others have done. **GET THIS BOOK.**

**SEND COUPON**

Send coupon to-day for special limited offer, including all instruments—you'll get full particulars by return mail.

**National Radio Institute**

Dept. BU5, Washington, D. C.

You get all of these



**Operates WMAQ**

"Accepted a position with Chicago Daily News—Station WMAQ. My income practically doubled thanks to your fine course."

KEITH KIMBALL, Chicago.



**Gets Big Job**

"Just been made Sales Manager of this Radio concern—a big raise in pay. Regret I did not take course sooner."

R. E. JONES, Bay City.



**Radio Needs Trained Men**

**LARGEST RADIO SCHOOL IN THE WORLD**

**ORIGINATORS OF RADIO HOME-STUDY TRAINING**



**MAIL THIS NOW**

**NATIONAL RADIO INSTITUTE**  
 Dept. BU5  
 Washington, D. C.

Without obligating me in any way, send me your free book, "Rich Rewards in Radio," and all information about your practical, home-study Radio course.

Name.....Age.....

Address.....

Town.....State.....

## best for condensers —brass

As plates and columns BRASS has the right temper to preserve alignment with small clearances. BRASS is readily soldered in making proper electrical contact and its easy machining qualities give economy in production.



**COPPER & BRASS**  
RESEARCH ASSOCIATION

25 Broadway, New York

22½ Volt  
un-acid  
everlasting  
rechargeable  
"B"  
Storage Battery  
**\$2.95**  
includes  
chemical



45 volts \$5.25, 90  
volts \$10.00, 112½  
volts \$12.50, 135  
volts \$14.75, 157½  
volts \$16.80.

Truly the biggest buy today. Easily charged on any current including 32 volt systems. Any special detector plate voltage had. Tested and approved by leading authorities such as Popular Radio Laboratories. Over 3 years sold on a non-red tape 30 day trial offer with complete refund if not thoroughly satisfied. Further guaranteed 2 years. Knock-down kits at greater savings. Complete "Hawley" "B" Battery Charger \$2.75. Sample cell 35c. Order direct—send no money—simply pay the expressman cost on delivery. Or write for my free literature, testimonials and guarantee. Same day shipments.

B. Hawley Smith, 312 Washington Ave., Danbury, Conn.

## What Constitutes a Radio Patent?

By LEO T. PARKER

*Patent Attorney*

**M**ANY radio experimenters overlook opportunities of obtaining the protection afforded by the patent laws, simply because they are unfamiliar with the rules by which to determine the kinds of radio inventions that present patentable possibilities. Others of these inventors and experimenters do not understand the essential requirements of an invention in order that a good patent may be obtained on it.

There are at least two very important things about which all experimenters should be familiar. One is what the word "invention" really means when it is construed in relation to radio circuits. The other is how the United States Courts have dealt with important radio patents in the past.

In the first place, the word "invention" really means any newly discovered thing or method which, when put to a practical test, will produce useful results. It makes no difference if the various parts or elements of which the invention consists are old and well known. The important requirement is that these old elements co-act to accomplish new and beneficial results. So, therefore, merely changing a wire in a radio circuit may effect an entirely new and patentable circuit, because the signals are received with improved tone quality, or the volume of the incoming signals is increased, or greater selectivity is effected, or any other of the many desirable results is attained.

Many individuals believe Marconi was the first person to discover wireless telegraphy. But he was not. Others had accomplished this result many years before him.

Going back to 1905, we find the first United States adjudicated radio patent was that of Marconi's reissue No. 11,913. The validity of this patent, after lengthy litigation, was upheld. His original patent was dated July 13, 1897, and related to apparatus used in transmitting electrical impulses and signals, particularly related to spark telegraphy. This original patent, however, did not protect the invention as he thought it should, so he cancelled it and had another patent issued in its stead.

During the legal controversy, various patents and experiments were brought to the attention of the court in an attempt to have Marconi's patent declared invalid, and considerable money was spent toward this end. Nevertheless, Marconi was declared to be the first inventor of wireless telegraphy.

One of the first methods to be utilized for the purpose of sending wireless messages was the Dolbear System. A conductive principle was employed on the banks of a body of water, and comprised primary and secondary circuits suitably positioned on the opposite banks, while wires were stretched along both banks and connected with the ground. By means of this improvised arrangement together with the assistance of batteries, galvanometers, and either telephone or telegraph instruments, the currents of electricity in the primary, generated by the batteries, were passed across the body of water to the terminal of the secondary circuit, thereby making and breaking the connections of the receiving apparatus, corresponding to the intermittent changes of the current set up in the primary circuit. However, the greatest distance covered by the Dolbear System was about two miles.

Another method of transmitting wireless messages had been used, consisting of the

principle of induction, and based upon the theory of an arrangement of primary and secondary circuits. A battery was connected with the primary which was positioned parallel with the secondary. By actual test it was found that a current made or broken in the primary circuit induces a transient current in the secondary circuit. This wireless system was successfully demonstrated prior to 1887, with the utilization of elevated conductors, vertical wires, and ground conductors, and messages were sent through the air for short distances. Also, in 1865, Professor Maxwell discovered that electricity, made manifest in the form of a spark, will spread out in waves or undulations similar to sound waves and he produced the effect by means of a special radiator.

However, the important difference between Marconi's invention and the prior ones was that Marconi realized his messages were sent through the ether by means of high frequency currents of electricity and, therefore, he was enabled to devise suitable instruments with which to increase the distances over which he could communicate, thus rendering the invention highly useful, and not a mere experiment.

In the patent specification Marconi referred to his invention as "Electrical signals, actions or manifestations, which are transmitted through air, earth, or water, by means of oscillations of high frequency."

Marconi, therefore, has been said to be the discoverer of the fact that high frequency currents are essential in the successful sending of wireless messages. He also invented instruments particularly adapted to send and receive this type of current. Although other persons before him had accomplished similar results through accident, they did not know why the phenomenon took place. In one sense of the word, all Marconi did was to adopt, improve, and elaborate upon existing theories, and put the various principles on a substantial working basis.

It should be remembered that, irrespective of how old or well known the elements of a new radio circuit or other invention may be, if by means of this new combination or arrangement the old elements are caused to co-act to perform new and different results, such an arrangement is a patentable invention. It does not matter how old or common the various parts or elements are, the important thing is whether, when acting together, they effect a new and unitary result or function.

### THE HETERODYNE PATENT

**A**LMOST every inventor knows that a basic patent is construed broadly in favor of the patentee, but many persons do not know that an invention need not relate to an entirely new science to be basic. It may relate merely to a new application of a well known thing, as is verified by a very recent United States Court decision on the validity of the heterodyne patent, which was declared to also cover the super-heterodyne principle.

Two patents were obtained by Mr. Fessenden on his invention of the heterodyne; one for the method of accomplishing the results and the other for the apparatus itself. The numbers of these patents are, respectively, 1,050,441 and 1,050,728, and any person desiring to examine the patents may secure them (and any others for that matter) merely by addressing The Commissioner of Patents, Washington, District



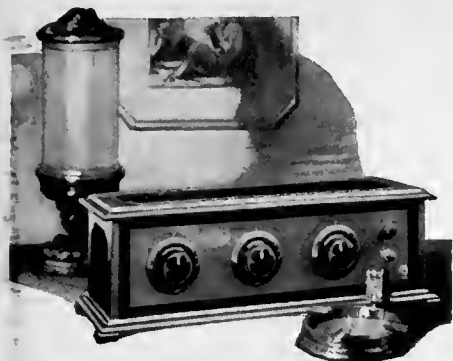

## ARBORPHONE

### What You Expect of Your Set

THERE are several thousand men and women, owners of Arborphone Receivers, who will tell you—

“You cannot equal my Arborphone—It’s all you could ask of a radio.”

Anyone can tune in enough stations to satisfy the most ambitious air-adventurer. From stations near or far there is a delightful ease of tuning and purity of tone quality unsurpassed in radio.

Arborphone gives you permanent radio. Like any good musical instrument your pleasure in Arborphone will be measured in years.

Housed in a really beautiful cabinet Arborphone lends a new charm to your prettiest room.

You cannot buy better radio—at any price. Ask any Arborphone owner or dealer.

Most interesting radio facts—written for everyone to understand—are described and illustrated in Arborphone Catalog. A copy sent free at your request.

\$55<sup>00</sup>

\$60.00 in Rocky Mt. and Pacific Coast States.

**MACHINE SPECIALTY COMPANY**  
ANN ARBOR, MICHIGAN

*This is a good time to subscribe for*  
**RADIO BROADCAST**  
*Through your dealer or direct, by the year only \$4.00*  
**DOUBLEDAY, PAGE & CO. GARDEN CITY, NEW YORK**

## Radio Dealers WANTED!

If you are the type of dealer who hustles after business, who isn't content to wait for trade to come in but who takes sets out to demonstrate, can talk and sell quality merchandise, and knows Radio values, we have a big proposition for you. Are you that dealer?

### 50% Discount to Dealers

We manufacture a complete line of high grade receivers and sell to dealers at 50% discount. We are distributors for more than 225 Nationally advertised lines.

**FREE** Write today for amazing offers, new 112-page catalog and regular monthly catalogs quoting below-the-market prices on latest merchandise—all free. Everything in Radio for less.

**AMERICAN RADIO MFG. CO.**  
1426 McGee St., Kansas City, Mo.



## BUY ALL YOUR FUTURE B-CURRENT NOW!



## RADIO PEP B-BATTERY ELIMINATOR

is unique in that it stops ALL the hum by using EIGHT perfected electrolytic cells and NO TUBES.

Plugged into the standard AC house lighting circuit RADIO PEP gives a silent, strong, dependable plate current that *improves the performance of your set* due to the effect of its huge condensers.

**ECONOMY!** No more drain of buying new batteries; and RADIO PEP takes so little current that you see no difference in your electric bills.

135 VOLTS are called for by the modern sets and tubes. RADIO PEP delivers 135 volts year after year without weakening.

Send for particulars and the address of the nearest dealer who can supply you. Money-back guarantee. Price, \$38.00.



**PEP MFG. CO., Inc.**

33 West 42nd Street

New York

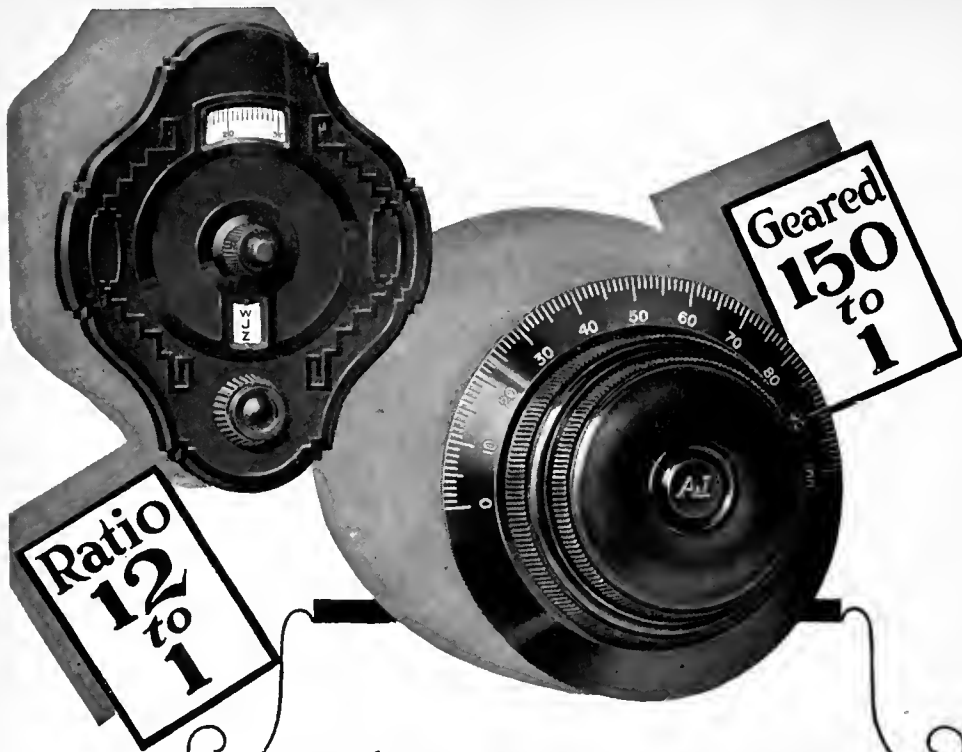

## What You COULD Get From Your Set

**I**T isn't what you're getting now. It's how much more you could get from your present set.

Your set may be one of the finest in the world but it can be no better than its dials.

The human hand cannot tune ordinary dials sufficiently accurate to bring in all the stations within scope of your set. That's where Science has stepped in with the two dials shown above.

MYDAR Recording Dial shown at the left above, offers a degree of tuning efficiency not usually associated with this price. Ample space for call letters insures permanent logging of all stations. Genuine Bakelite, handsomely embellished—12 to 1 Ratio. Price \$1.75.

The A. J. (Vernier) shown at the right above, geared at 150 to 1, brings tones into sharp focus like a fine camera lens. Beautiful, dignified. Genuine Bakelite. A master product of master craftsmen.—Price \$2.25.

Accuratune (not shown) geared 80 to 1 is admirably suited to every type of tuning requirements.

*No panel drilling necessary to substitute any one of these dials.*

★ **MYDAR Radio Company**  
3 CAMPBELL STREET  
NEWARK, N. J.

of Columbia, and enclosing ten cents for each copy specified by the numbers.

Heterodyne, as applied to radio, is a method by which signals are produced by beats, whose frequency is equal to the difference between that of a transmitted frequency and that of locally produced oscillations. This accomplishment was the important consideration for which Mr. Fessenden was granted patents.

Broadly speaking, the method of generating local oscillations, as performed by Mr. Fessenden, was a beat system, old and well known in acoustics. The same results have been produced many times by means of various musical instruments, such as tuning forks, pianos, etc. In other words, he simply applied a well known scientific principle to a different purpose whereby new and beneficial results were accomplished—an absolutely safe foundation upon which a highly valuable and valid patent may be obtained.

The courts regard the heterodyne invention as one of the highest order and entitled to a very broad scope, because it was the first application of the old beat system in radio apparatus.

Another important thing to remember is that Mr. Fessenden's patents do not infer or suggest that his invention is intended for voice or concert reception. Notwithstanding this, the court refused to limit the patent and sustained it as a basic patent which covers any kind of beat system of radio reception, including the super-heterodyne receiving set.

At a later date a Mr. Vreeland applied for certain super-heterodyne patents but the courts decided that although his patents Nos. 1,239,852 and 1,245,166 on the super-heterodyne circuit doubtless improved Mr. Fessenden's invention, he could not build his circuit without infringing. This decision brings out another important point, namely, that an improver of a valid patented radio circuit cannot proceed to build his improvement, in which is incorporated the original circuit, without paying a royalty to the original patentee.

Mr. Vreeland contended that, while his patent may infringe Mr. Fessenden's patent, it goes beyond it and makes a substantial contribution to the original patent. In spite of obvious differences between the heterodyne and super-heterodyne circuits, the heterodyne patents are broadly construed, in favor of the inventor, to cover the super-heterodyne principle of receiving incoming signals, even though the beat system is old in acoustics, and Mr. Vreeland's claim could not be sustained.

### IMPORT DUTY ON RADIO GOODS FOR AUSTRALIA

**A** CONSIDERABLE amount of American and British radio apparatus is now on the market in Australia, and there is keen competition between these two importing countries. Contrary to general opinion, even Britain is charged duty on her imports, but the percentage is not so high as it is for American apparatus. Radio sets imported into Australia from this country are chargeable at the rate of 55 per cent. ad valorem, while British set manufacturers are required to pay a duty of only 35 per cent., according to the *Broadcaster and Wireless Retailer* of London. An intermediate figure of 50 per cent., is applicable to certain countries. British tubes were allowed into Australia duty free until January 1st of this year, but a 27½ per cent. duty is now levied. American tubes are taxed at the rate of 40 per cent. ad valorem. The general tariff on tubes was only 15 per cent. until recently. There is an intermediate tariff of 35 per cent. on tubes from certain countries. A general revision of duties on radio apparatus came into force on January 1st.

# CHELSEA

Super Five \$50.00



## The Ideal Receiver!

ADVANCED engineering and years of production experience by one of the oldest radio manufacturers in the country produced the new Chelsea Super-Five—a Receiver with performing features and refinements found in much higher priced sets.

Fine mahogany finish cabinet with graceful sloping panel and large dials for easy tuning. Convenient cord leads (no unsightly binding posts). Foolproof, dust-proof inside panel to protect delicate parts. Rugged bus-wiring, hand-soldered connections and other refinements. This Set delivers wonderful tone quality and volume and is one of the most selective sets on the market.

Choose Chelsea and save the difference

Write us to-day for New Descriptive Folder

CHELSEA RADIO CO.  
Chelsea, Mass. ★

RADIO FANS, a one-year's subscription to Radio Broadcast will cost you four dollars, two years six dollars. Consider this expenditure as being a necessary investment on your part for the future development of your own knowledge of Radio.

## MOUNTFORD

**FITS ANY MOUNTING 50¢**

**PLUNGER TYPE VARIABLE GRID LEAK**

Perfect graduation, obtains all fractions of a megohm from 1/4 to 20 inclusive. Increases selectivity and sensitivity. Unaffected by heat or cold. Maintains accuracy of range and consistency of resistance. At your dealers or postpaid upon receipt of price. We also manufacture the Mountford Resistance Coupled Kit, Price postpaid \$6.50.

**C. E. MOUNTFORD ★**  
469 Greenwich St.  
New York City

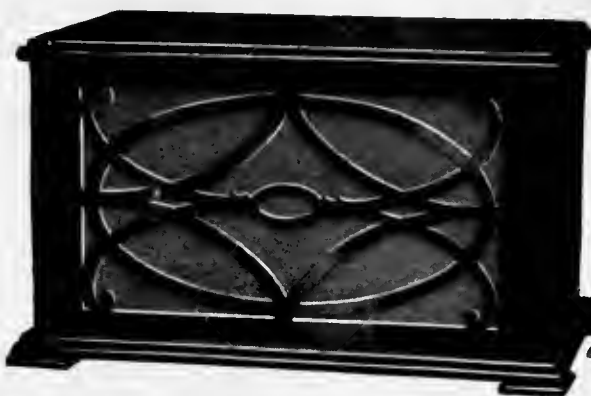

Super C, \$30

The New SUPER UNIT

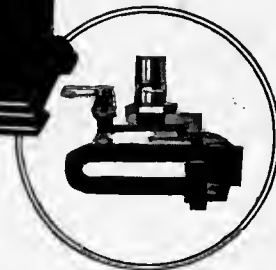

This Speaker



## Has the NEW VOICE!

THE small diaphragm commonly used reproduces the middle and upper notes of the musical scale well enough, but it leaves much to be desired from the middle down. Verify this yourself. Listen to almost any speaker and you will be amazed at the muffled sound of the middle and lower registers of voice and instrument.

The Bristol Speaker is equipped with that latest discovery in tone reproduction, the SUPER-UNIT. This unit contains an unusually *large diaphragm* which brings in the full range of tones from deep bass to high treble.

The rumble of the tympani, the roll of the snare drum, the low tones of the viols, tuba, organ, saxophone and voice—notes you've never before heard in radio—notes which are even more vital in reproduced music than in an actual concert—are clearly and naturally audible.

The cabinet is highly polished mahogany, 17 x 10 x 10 1/4 inches in size, with long, freely vibrating sound chamber. The price is \$30. Ask your dealer for a demonstration and at the same time.

Send for FREE BOOKLET

entitled, "How to Select Your Loud Speaker." It tells how to look for and find tone quality in a speaker.

## BRISTOL SPEAKER

(AUDIOPHONE)

The Bristol Company Radio Div. AH, Waterbury, Conn.  
For 36 years makers of the highly sensitive and accurate Bristol's Recording Instruments

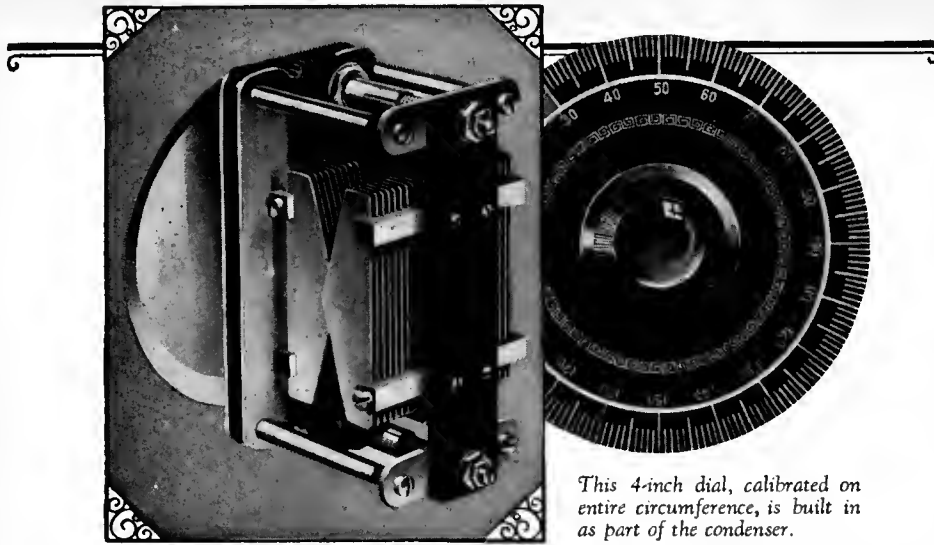

This 4-inch dial, calibrated on entire circumference, is built in as part of the condenser.

## "Spreads" Stations All Over the Dial

**S**TATIONS won't overlap one another when you use the Wade Condenser Tuning Unit. This unique condenser is geared to a dial that is graduated all the way around—from zero to 360 degrees. This means twice as much space between stations for close tuning adjustment; even wider separation of stations than the rotor plate types of straightline frequency condensers using standard 180 degree dials. If you are one who is tuning now with only "half a dial" you are in for a pleasant surprise when you try Wade Condenser Tuning Unit. It covers the whole broadcast range and down below 200 meters.

### Wade Tuning Unit Including Condenser and Dial

The Wade Condenser Tuning Unit consists of a Wade Condenser geared to a four-inch 360 degree vernier dial of 16 to 1 ratio. Prices are for the complete unit.

Capacity .00125 mfd. **\$6.00**

Capacity .0025 mfd. **\$6.25**

Capacity .00035 mfd. **\$6.35**

Capacity .0005 mfd. **\$6.50**



### No Body Capacity Effects

A separately grounded frame, insulated from both sets of plates, shields the condenser from all body capacity effects—an important feature, exclusively in Wade Condensers.

The Viking Tool and Machine Co. Inc. 745-A 65th Street, Brooklyn, N. Y.

# WADE

Why not subscribe to *Radio Broadcast*? By the year only \$4.00; or two years, \$6.00, saving \$2.40. Send direct to Doubleday, Page & Company, Garden City, New York.

## ELDREDGE PANEL METERS \$5.00

Why pay more? Eldredge meters are accurate and long-lived.

If dealer can't supply you, write us direct

Dept. B

Eldredge Electrical Corporation

Springfield

★  
Mass.

Established 1892

## A KEY TO RECENT RADIO ARTICLES

By E. G. SHAULKHAUSER

**T**HIS is the fourth installment of references to articles which have appeared recently in various radio periodicals. Each separate reference should be cut out and pasted on cards for filing, or they may be pasted in a scrap book either alphabetically or numerically. A brief outline of the Dewey Decimal System (employed here) appeared in November and January RADIO BROADCAST.



R800(535.3) PHOTOELECTRIC PHENOMENA. PHOTOELECTRIC CELL.  
*Radio News*. Oct. 1925, pp. 436ff.

"The Lumino-tron," T. H. Nakken.

The description of a new type of photoelectric cell, and its application to many unsolved problems, is outlined by the inventor in this article. The cell is of the potassium plate type. Its fundamental working principles, and some of the results obtained with the tube, make this cell very reliable.

R550. BROADCASTING. BROADCAST RANGE, Covering the.  
*Radio News*. Oct. 1925, pp. 446ff.

"Extending the Broadcast Range," S. Harris.

A possible expansion of the present broadcast band will necessitate changes in most radio receivers to cover the entire range. The difficulties encountered and the best solutions are presented in an excellent discussion by the author, who comes to the conclusion that tapped coils will most likely be necessary.

R343. ELECTRON TUBE RECEIVING SETS. RECEIVER, 2000-600 kc. (150-600m).  
*Radio News*. Oct. 1925, pp. 448-449.

"Another Three-Range Receiver."

Anticipating an expansion in the broadcast band of wavelengths, the receiver here described and illustrated uses a novel scheme in covering the range. Sets of coils of three sizes are built, and mounted to fit into an ordinary tube socket. The receiver is of the regular two-stage radio frequency type, using three tuning dials.

R113.8 ECLIPSES. ECLIPSE, SOLAR.  
*Proceedings I.R.E.* Oct. 1925, pp. 539-569.

"The Effect of the Solar Eclipse of Jan. 24, 1925, on Radio Reception," G. Pickard.

A complete résumé of the observations made under the direction of the author, is presented, with diagrams and illustrations. The data collected lead to certain conclusions and put us several steps ahead in our search for information concerning the behavior of ether waves in space.

R331. CONSTRUCTION OF VACUUM TUBES. VACUUM TUBES, X-L filament.

*Proceedings I. R. E.* Oct. 1925, pp. 589-609.

"The Application of the X-L Filament to Power Tubes," J. C. Warner and O. W. Pike.

The properties of the X-L or thoriated tungsten filament, are discussed, with particular reference to the suitability of this material for use in power tubes and its advantages over other materials. Comparisons are given between pure tungsten and thoriated tungsten filaments in electron emission characteristics and effect on tube design, and performance. Several power tubes containing X-L filaments are described in detail. The improvements due to the use of the X-L filament are illustrated by comparison of these tubes with older types of tubes containing pure tungsten filaments.

R375. DETECTORS AND RECTIFIERS. RECTIFIER, Raytheon.  
*QST*. Nov. 1925, pp. 38-40.

"The Raytheon Rectifier," M. Pennybacker.

A theoretical discussion of a new rectifier tube, the Raytheon, is given by one of the manufacturer's engineers. The tube is a full-wave rectifier, and has many new features which make it exceptionally well adapted to B battery eliminator operation, according to the author. The curve in Fig. 5 shows the relation of output voltage to output current. A completed rectifier unit is shown in a photograph.

R350. GENERATING APPARATUS; TRANSMITTER, Crystal-Control.  
*QST*. Nov. 1925, pp. 41-44.

"Navy Developments in Crystal Controlled Transmitters."

A detailed account of the developments of crystal controlled transmitters at the Naval Research Laboratory, Bellevue, District of Columbia, is given, beginning with the first experiments, May 1st, 1925. Most of the research has been done on short waves, according to the account given. Various types of sets tested, results obtained on different frequencies, and power input, are described, and photographs shown for the benefit of the experimenter who desires this information. The data presented is all of an experimental nature.

R343. ELECTRON TUBE RECEIVING SETS. RECEIVER, Loop.  
*Radio*. Nov. 1925, pp. 25-26.

"An Improved Loop Receiver," R. L. Rockett.

A five-tube loop receiver, employing three stages of radio frequency amplification, is presented, with data on construction and assembly. One audio stage is reflexed.

R343. ELECTRON TUBE RECEIVING SETS. RECEIVER, Short-Wave.  
*Radio*. Nov. 1925, pp. 27ff.

"Building for the Future," H. A. Nickerson.

Many stations can be heard broadcasting programs on very high frequencies (wavelengths below 100 meters) with a receiver designed for that purpose. Such a receiver is described in this article. It is a simple regenerative arrangement.



**Oh boy!**  
**KESTER**  
*Rosin Core*  
**Radio SOLDER**  
*Sure is Safe and Simple*

Approved by  
**Radio Engineers**  
*A Genuine Solder*

CHICAGO SOLDER COMPANY  
 4222 Wrightwood Ave., Chicago, U.S.A.

Originators and  
 World's Largest Manufacturers of  
 Self Fluxing Solder

YOUR DEALER  
 CAN SUPPLY YOU



**KORACH**

Tuned Loop  
 Multiple Switch  
 Board Tuner  
 Directional  
 Base Compaas for  
 Logging  
 Collapsible

For Those Who Demand  
**SUPERIOR RESULTS**

Leads the merch towards perfect radio reception under all conditions. Not merely a "loop" but an ingenious arrangement of mechanical skill designed for superior results. L. M. Cockaday, using this loop, reached out across the Atlantic to audibly hear many trans-continental stations. Selectivity Plus Distance unheard of with common loop aeriats. The Korach excels on all sets designed for loop reception. Priced at \$12.50. and for sale by all good dealers. Full particulars sent for 2c stamp and name of local dealer.

**KORACH RADIO CO.** ★  
 20 E. Jackson Blvd., Dept. 8, Chicago, Ill.  
 Dealers and Jobbers: Write today for attractive proposition.

The Korach Junior  
 A modification of  
 the "Senior" but possess-  
 ing all its important features—\$10.00.

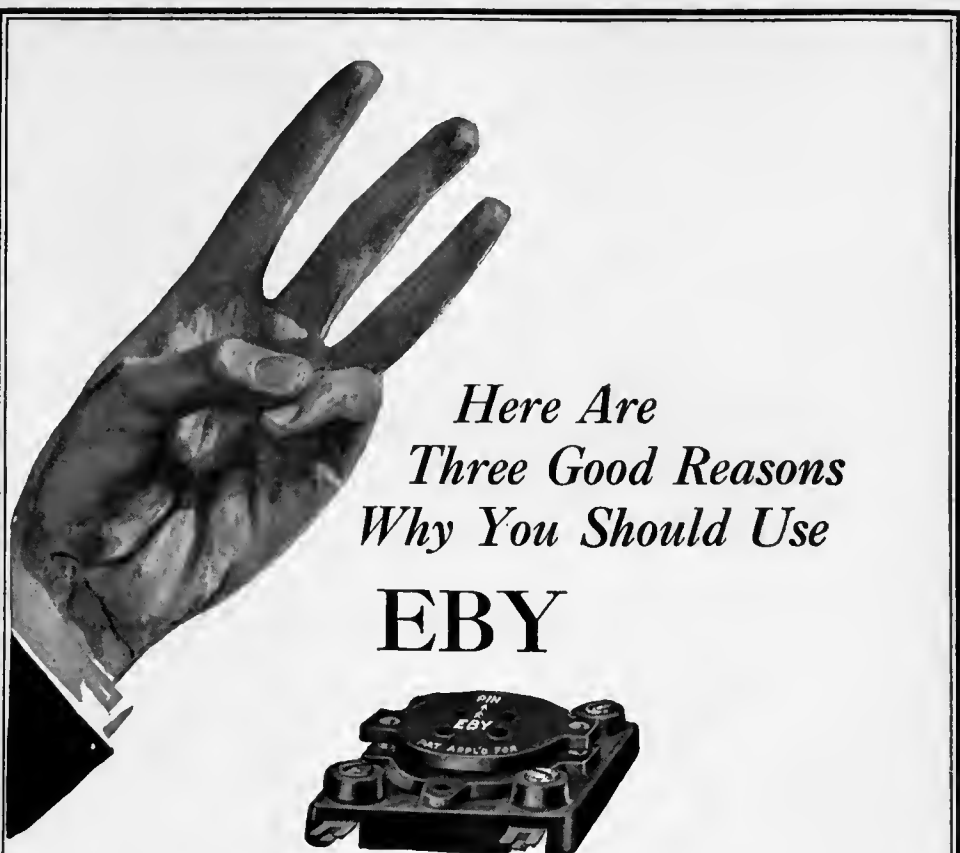

Here Are  
 Three Good Reasons  
 Why You Should Use  
**EBY**



**SPRING SOCKETS**

- 1 *A three point wiping contact* that insures a positive contact at all times regardless of the size of the prong or amount of solder on the prong tip.
- 2 *Its ingenious design* permits the tube to "float" when in service. This feature reduces microphonic noises to a minimum and prevents tube damage.
- 3 *All the advantages of interchangeability* of the new UX, CX, and UV tubes for 6oc. Don't take chances on twenty loose connections in a five-tube set. Use the new EBY positive contact sockets for better reception.

*If you dealer can't supply you  
 write to us sending his name.*

**H. H. EBY MANUFACTURING CO.**  
 4710 Stenton Ave., Philadelphia



This is the EBY Binding Post that is standard equipment on eight out of ten of the radio receivers made in America—your dealer has all of the 27 different markings.

Now you can hear ALL notes!

A Thordarson Autoformer Amplifier built in accordance with instructions and diagrams furnished with each Autoformer

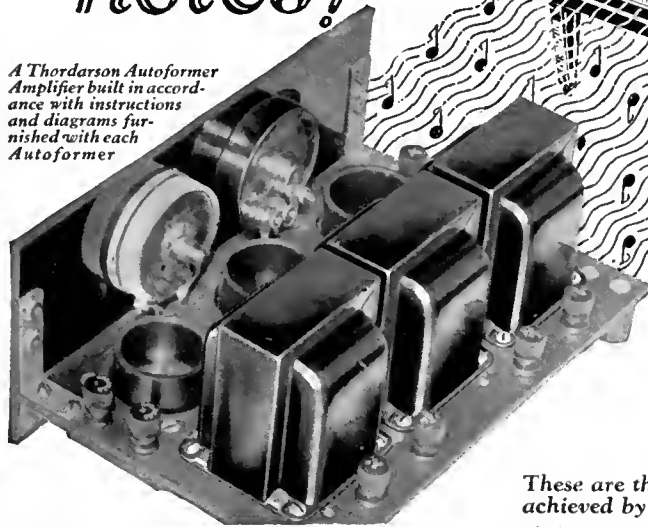

These are the four great improvements achieved by Autoformer Amplification

- 1 Full amplification of those bass notes hitherto largely "lost."
- 2 Greater clarity on all notes.
- 3 Improved reception of distant programs.
- 4 Better volume control.

Deepest Bass to Highest Treble Brought Out Clearly

The Thordarson Autoformer is not "another transformer." It is an all-frequency amplifier, an entirely new instrument developed and built only by Thordarson. Autoformer Amplification is step-up impedance coupled with capacities and resistances. Write for fully descriptive literature. Autoformers, \$5 each. Dealers everywhere.

**THORDARSON**  
Autoformer

Trade-Mark Registered  
All Frequency Amplifier

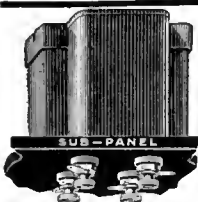

Other Thordarsons

Thordarson Super Audio Frequency Transformers in either sub-panel or top mounting type. Three ratios: 2-1, \$5; 3 1/2-1, \$4; 6-1, \$4.50. Thordarson Power Amplifying Transformers, \$13 the pair. Thordarson Interstage Power Amplifying Transformers, \$8 each. All Thordarson products are unconditionally guaranteed.

**THORDARSON ELECTRIC MANUFACTURING CO.**  
Transformer specialists since 1895  
WORLD'S OLDEST AND LARGEST EXCLUSIVE TRANSFORMER MAKERS  
Chicago, U.S.A.

ZENITH  
KENNEDY  
Radiodyne  
Planstiehl  
Howard  
Thermodyne  
OZARKA  
Deresnadyne  
ADLER-ROYAL  
MURDOCK  
MU-RAD  
Valleytone  
LEICH  
Silver-Marshall  
GLOBE  
Newport  
BUCKINGHAM  
NUNN-LONDON  
KUSTOMBILT and many others  
use Thordarson Super-Amplifying Transformers

Also choice of the MacMillan Arctic Expedition

R800(535.3) PHOTOELECTRIC PHENOMENA. PHOTOELECTRIC CELLS.  
*Popular Radio*. Nov. 1925, pp. 397-404.  
"The Photoelectric Cell," E. E. Free.  
The development of photoelectric cells is an outgrowth of radio progress. This cell is used to convert light beams into a stream of electrons. Their efficiency, at present, is very low, and the most modern cells still use as active metal either potassium, sodium, lithium, caesium, or rubidium. The action taking place within the tube is vividly described.

R375. DETECTORS AND RECTIFIERS. RECTIFIER, RAYTHEON.  
*Popular Radio*. Nov. 1925, pp. 405-414.  
"Raytheon Plate Supply Unit," L. M. Cockaday.  
This article describes the new B battery eliminator unit using the Raytheon tube. Cost of parts is given at about \$45.00. The tube has no filament and will last practically indefinitely. A detailed description covering the operation of the unit, and method of constructing, wiring, and testing, is given.

R800(621.314.3) TRANSFORMERS. TRANSFORMERS.  
*Popular Radio*. Nov. 1925, pp. 444-452.  
"Practical Pointers About Transformers," F. E. Nimmcke.

This article gives practical information concerning the design, construction, and operation of small transformers, as used in radio engineering. Mathematical equations and reference examples serve to help the radio engineer in comprehending the problems in question.

R110 RADIO WAVES. RADIO WAVE THEORY.  
*Popular Radio*. Nov. 1925, pp. 461-464.  
"Alexanderson's Theory of Twisting Waves," F. W. Alexanderson, is illustrated by diagram, and discussed. The phenomenon of polarization, and the effect of the magnetic field of the earth on such polarized waves, is taken as a probable explanation of fading signals, and so called "dead-spots."

R333. THREE-ELECTRODE VACUUM TUBES. VACUUM TUBES.  
RADIO BROADCAST. Dec. 1925, pp. 163-166. *New types.*  
"Tubes: Their Uses and Abuses," Keith Henney.

The condition under which present-day vacuum tubes must be operated to get best results, are related. A brief but very practical discussion on theory and operation of the detector tube, regeneration in the detector circuit, audio and radio amplification where voltage as well as power amplification must be considered, importance of matching output impedance of last tube with loud speaker impedance, transformer ratios, resistance-coupled audio amplifiers, are questions receiving attention. The author gives considerable information concerning the new power amplifier tubes, ux-120, ux-112, Daven mu-6, Cleartron 112, WE-216-A, and others.

R343. ELECTRON TUBE RECEIVING SETS. RECEIVER.  
RADIO BROADCAST. Dec. 1925, pp. 172-176.  
"A Five-Tube Receiver of Dual Efficiency," G. H. Brown-

ing.  
The receiver described is an improvement of the one previously described in RADIO BROADCAST (December, 1924). Three stages of impedance coupling are used in the audio circuit. The construction of the tuned radio frequency stages is very important. From the curve it appears that when frequency is plotted against voltage amplification, the Daven mu-20 and mu-6 tubes, with impedance coupling, will give greatest amplification without distortion when compared to other methods of amplification. Parts listed, and diagrams covering constructional details, enable the builder to follow instructions without difficulty. The author lays stress on the careful construction of the Regenerator, and gives a very simple method of balancing the r. f. stage, using a small disc of metal brought near the coil winding.

R545. AMATEUR RADIO. SHORT WAVES FOR AMATEURS.  
RADIO BROADCAST. Dec. 1925, pp. 182-184.  
"Short Waves—A New Paradise for the DX Fan," E. H. Felix.

The great interest manifested in high frequency telegraph transmission by the so-called radio amateur, is depicted in this article. Short-wave stations communicate by code generally using small power transmitters (5 watts being a common output). Such apparatus can be constructed for sums of \$20.00 and up. The receivers are very simple and rarely use more than two tubes. The thousands of dyed-in-the-wool "hams" are at their game day and night and their work constitutes a most important link in the progress of radio.

R375. DETECTORS AND RECTIFIERS. RECTIFIER, RAYTHEON.  
RADIO BROADCAST. Dec. 1925, pp. 186-190.  
"An Improved Plate-Current Supply Unit," R. F. Beers.

The operation of the Raytheon rectifier tube in B battery eliminator circuits, is discussed. The tube is rated at 60 milliamps. at 150 volts d. c. output; is very quiet in operation, and has good characteristics as shown by the curve. Back currents are not detectable in the tube, and consequently all filtering problems are simplified. There is no filament in the Raytheon tube. Data is given enabling the constructor to build his own transformer and choke coils.

R113.6 REFLECTION; REFRACTION; REFLECTOR, PARABOLIC.  
DIFFRACTION.  
*Radio*. Nov. 1925, pp. 13ff.  
"Short Wave Reflectors," R. C. Hunter.

Method of constructing a parabolic reflector for the range from 400,000 kc. to 401,000 kc. (7496-7477 meters) is given. This information can be used for building larger reflectors to operate on lower frequencies. The size here described can be placed in a small space in a laboratory, dimensions being about 66 x 30 x 18 inches. Diagrams and illustrations supplement the article.

R342.7 AUDIO-FREQUENCY AMPLIFIERS. AMPLIFIERS, AUDIO-FREQUENCY.  
*Radio*. Nov. 1925, pp. 16-18.  
"An Ideal Audio-Frequency Amplifier," E. W. Pfaff.  
A three stage impedance-coupled amplifier, for which unusual amplification quality is claimed, is described. The theory of the circuit, and the construction of the set, including list of parts, are presented in detail.

This is a good time to subscribe for  
**RADIO BROADCAST**  
Through your dealer or direct, by the year only \$4.00  
DOUBLEDAY, PAGE & CO. GARDEN CITY, NEW YORK

Send for Latest RADIO CATALOG and GUIDE

Sets—Parts—Kits  
Radio's Newest

You need this big FREE book. A practical guide to success in set building. Gives advanced hook-ups. Shows all newest parts and kits, built up sets ready for use, battery eliminators, radio's newest creations. Write for Copy free, also send name of radio fan. Send to-day.

**BARAWIK CO.**  
102-208 S. Canal St., Chicago

The LATEST HOOK-UPS & RADIO Catalog

Attention Dealers  
SEND FOR OUR 200 PAGE CATALOG

**RADIO SUPPLIES**  
**SCHNEITERS**  
TRADE MARK  
ST. JOSEPH, MO.

The finest and largest exclusive Radio Catalog in the United States  
**SCHNEITZER RADIO COMPANY**  
Dept. 10 St. Joseph, Missouri

# This RADIO BOOK will save you money

514 PAGES ONLY \$1



Compiled by HARRY F. DART, E.E. Formerly with the Western Electric Co., and U. S. Army Instructor of Radio. Technically edited by F. H. Duano.

THE I. C. S. Radio Handbook will help you to get more enjoyment out of radio. It clears up the mysteries—tells you just what you want to know. Written by nationally known radio authorities in language that you can understand. An absolute necessity for every radio fan. A wonderful bargain at \$1. Note this partial list of contents—

Electrical terms and circuits, antennas, batteries, generators and motors, electron (vacuum tubes), many receiving hook-ups, radio and audio frequency amplification, broadcast and commercial transmitters and receivers, super-regeneration, licenses, etc.

Send \$1 today and get this 514-page I. C. S. Radio Handbook—the biggest value in radio today

International Correspondence Schools  
Box 8298-E, Scranton, Penna.

I enclose One Dollar. Please send me—post-paid—the 514-page I. C. S. Radio Handbook. It is understood that if I am not entirely satisfied I may return this book within five days and you will refund my money.

Name.....

Address.....

Check here  and enclose \$1.50 if you wish the edition bound in Leatheroid

IF you like this magazine with its coated paper and enlarged size—then why not subscribe and get it regularly—by the year, \$4.00, Six months, \$2.00.

Doubleday, Page & Co.  
Garden City New York

## RADIO OWNERS

who can twirl a dial can renew their old tubes without chance of error with this instrument. It is built so that it cannot be mis-operated.

YOU CAN DO IT YOURSELF WITH A

**BURTON & ROGERS TUBE FLASHER**

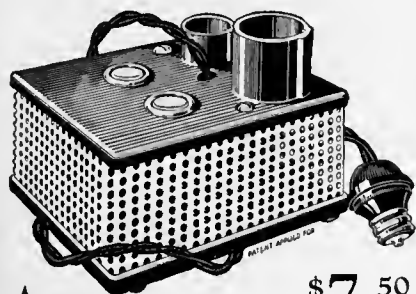

\$7.50

One Model for D. C. or A. C. all cycles For tubes with thoriated filaments.

BURTON & ROGERS MFG. CO.  
755 Boylston Street Boston, Mass.



# ACME WIRE RADIO PRODUCTS

## Celatsite Battery Cable

For connecting A and B Batteries (or current supply) to radio set. Silk braid covering 5 flexible Celatsite wires—5 feet long—a different color for each terminal. Prevents messy wiring and "blown" tubes. Adds greatly to the appearance of your set.



## Stranded Enameled Antenna

The best outdoor antenna you can put up. 7 strands of enameled copper wire; maximum surface for reception. Enameling prevents corrosion and consequent weak signals. 100, 150 or 200 foot coils, boxed.



## Loop Antenna Wire

You can make a good loop with Acme wire made of 65 strands of fine copper wire, green silk covered. Flexible; non-stretching, neat.



## The Original Celatsite Wire

Celatsite is a tinned copper bus bar wire with a non-inflammable "spaghetti" insulation in five colors. Supplied in 30 inch lengths.

## Flexible Varnished "Spaghetti"

A perfect insulation tube for all danger points in set wiring. Costs little more and is worth a lot more than the cheaper substitutes offered. Black, yellow, red, green, brown, for wires No. 10 to No. 18. 30 inch lengths.

## Flexible Celatsite Wire

Flexible stranded wire for "point to point" and sub-panel wiring—latest method of wiring sets. 5 colors, black, yellow, green, red and brown, one for each circuit. 25 ft. coils.



Send for Folder

THE ACME WIRE CO., Dept. B  
New Haven, Conn. ★

# Make your set a Super-Het

THE circuit described in Radio Broadcast for June and August will change any set into a super-heterodyne. It is particularly applicable to five-tube neutrodyne and tuned RF sets. It changes these two circuits into super-heterodynes as good as most, and considerably better in some respects than any super-heterodyne circuit ever devised.

Stations come in at but one point on the oscillator dial. There is mathematically no possibility of harmonics. Full scale blue prints with reprint of article \$1.00.

- Eastern Coil antenna coupler..... \$6.00
- O'Connor oscillator coupler..... 4.75
- Special fixed condenser..... .60
- Complete parts including panel, drilled and engraved, special formica bushings, screws, and wire, blue prints and reprint..... 37.50

★ **A. O'CONNOR & COMPANY**  
Super-Heterodyne Headquarters Since 1923  
9702 Euclid Avenue . . . . . Cleveland, Ohio

*The moustache, the beard and the bustle are hopelessly out of date. But no more so than the obsolete slow 2-ampere battery charger!*

**Buy nothing but an up-to-date 5-ampere charger!**

*The New Improved*  
**5 AMP. A & B**  
**GOLD SEAL**  
**HOMCHARGER**  
**\$19.50**



Over 500,000 already in use

# Modern-Fast-Efficient!

**N**OW you don't have to wait for days while your battery charges. The new 5-ampere GOLD SEAL HOMCHARGER charges A or B batteries three times as fast as last year's slow chargers - - - it fully charges the average radio battery OVERNIGHT!

This year when you buy a battery charger, be sure it is a modern fast charger - - - one that charges at 5-amperes. To be absolutely sure, insist on the 5-ampere GOLD SEAL HOMCHARGER.

*Free* Write for new edition of our interesting 16-page booklet "The Secret of Distance and Volume in Radio." ★

**THE KODEL RADIO CORPORATION**  
 505 EAST PEARL ST. CINCINNATI, OHIO

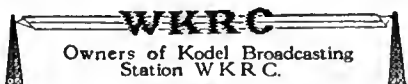

This is a good time to subscribe for  
**RADIO BROADCAST**  
 Through your dealer or direct, by the year only \$4.00  
 DOUBLEDAY, PAGE & CO. GARDEN CITY, NEW YORK

**Play Jazz**  
 in a week

on your **Buescher Saxophone**  
 You can do it—easy. 3 lessons free with each new instrument give you a quick start. Practicing is fun because you learn so fast. And it will make you popular, in demand, the center of attraction everywhere you go. Always a hit. Even if you have failed with some other instrument, you can learn the simplified Buescher Saxophone. Don't delay. Get into the big fun. Any instrument sent for 6 days' free trial. Easy terms if you decide to buy. Write now for beautiful, free literature. Address:



Buescher Band Instrument Co. 11  
 1219 Buescher Block Elkhart, Indiana

**If Your Set Won't Percolate**

write us about it. RADIO BROADCAST is establishing a special repair department to assist set builders in getting the best out of the receivers they build from plans published in the magazine. Write for complete information about this new department established for your benefit.

★ Tested and approved by RADIO BROADCAST ★

R380. PARTS OF CIRCUITS; INSTRUMENTS. METERS, RADIO BROADCAST. Dec. 1925, pp. 198-200. *Use in Receivers.*  
 "How to Use Meters in Your Receiver," James Millen.  
 A voltmeter for the filament circuit, and one for the B batteries, is recommended. A plate milliammeter gives the plate current drain and shows when audio amplifiers are properly "modulating." Method of connecting meters, and the various uses to which they can be put otherwise, is given; several "meter circuits" are shown.

R344. ELECTRON TUBE GENERATORS. OSCILLATORS, RADIO BROADCAST. Dec. 1925, pp. 201-204. *Modulated*  
 "New Fields for the Home Constructor," Keith Henney.  
 For those who have accumulated radio apparatus and tools, and really want to know more about radio science and what is going on in the laboratory, this second article of a series is given. A method of testing open circuits in audio transformers by means of 1000-cycle oscillator, and obtaining transformer characteristics with the same oscillator, is described. Other uses of the oscillator are suggested, and taken up in some detail. The previous article in this series appeared in the September, 1925, RADIO BROADCAST.

R115. DIRECTIONAL PROPERTIES. BEAM TRANSMISSION. *Radio.* Nov. 1925, pp. 10ff.  
 "Marconi Radio Beams," H. de A. Donisthorpe.  
 The advent of beam transmission will relieve other congestion, and make obsolete existing high-power long range stations of to-day, according to the writer. Beam transmission will give minimum interference, due to marked directional effects. Early experimental work is discussed, and modern improvements made, due to the invention of vacuum tubes, are described. The size and method of constructing reflecting surfaces have given rise to new theories of wave transmission. Parabolic and flat reflectors have been used, the latter with marked results. A flat network of wires set horizontally, serves as an antenna, while another similar network, placed 1/4-wavelength back, serves as the reflector. This system will concentrate energy within 10°, making possible thirty-six times the transmitted energy otherwise obtained at a point.

R342.6 RADIO-FREQUENCY AMPLIFIERS. AMPLIFIERS. *Radio.* Nov. 1925, pp. 14-15. *Radio-Frequency*  
 "A Universal Radio-Frequency Amplifier," A. J. Haynes.  
 A radio-frequency amplifier, which can be used ahead of any receiving set, is described. Careful construction is emphasized. The circuit employs an effective means of controlling oscillations. This is done through the use of a tuned choke coil, as is evident from a study of the circuit diagram. Sufficient data is presented to enable the experimenter to construct this set. Unusual sensitivity and volume are supposed to be the prime features incorporated in this amplifier.

R007. BIOGRAPHICAL. BIOGRAPHY. *Radio.* Nov. 1925, pp. 19ff. *M. Latour.*  
 "Marius Latour," W. Emmett.  
 A short biographical sketch of M. Latour, the French scientist and philosopher, is presented. Mr. Latour is not only known as a student of science, but his writings in the field of sociology and psychology are widely read. He has many patents to his credit, some of which are discussed in this article.

R145.3 INDUCTANCE. INDUCTANCE COILS. *Radio.* Nov. 1925, pp. 24ff.  
 "Comparative Efficiencies of Coils," J. E. Anderson.  
 The L/I ratio of inductance coils is regarded as a measurement of the efficiency of coils at low as well as high frequencies. From this standpoint, the author makes a comparison of various forms and types of coils, including two and three layer banked coils, single layer coils of various shapes, Lorenz coils, spiderweb coils, toroidal coils, etc. The conclusions arrived at are summed up at the end of the discussion.

R133. GENERATING ACTION. ELECTRON TUBE GENERATORS. *Radio.* Nov. 1925, pp. 29ff. *Lieut. J. B. Dow.*  
 "The Vacuum Tube as a Generator," Lieut. J. B. Dow.  
 A theoretical as well as practical analysis of the fundamental principles of vacuum tubes, is presented, for the benefit of the amateur building his own transmitter. Information is given of the effect of gas in the tube, on the grid, the internal resistance, the amplification factor, the dynamic characteristics, the mutual conductance, the generator action, etc. Schematic circuit diagrams illustrate the discussion.

R375. DETECTORS AND RECTIFIERS. RECTIFIER, *Radio.* Nov. 1925, pp. 35-36. *Raytheon.*  
 "The Helium Tube Rectifier," E. E. Turner.  
 The Raytheon tube rectifier and its use in B battery eliminators, is discussed. Complete description on building a practical eliminator, including list of parts required and diagram, is given. No hum of any kind is heard in the loud speaker, even when the outfit is delivering 37 milliamps. on a ten-tube super-heterodyne set, according to the writer.

R350. GENERATING APPARATUS. TRANSMITTING SETS. TRANSMITTERS, *QST.* Nov. 1925, pp. 15-19. *Skip.*  
 "KFUH," Ralph M. Heintz.  
 The transmitter aboard the ship *Kaimiloa*, call KFUH, consisting of two 250-wattors, is discussed in detail. Circuit diagrams and photographs give a clear idea of the set, and how it has been constructed. The results obtained have been very gratifying.

RR342.6. RADIO-FREQUENCY AMPLIFIERS. AMPLIFIERS, *QST.* Nov. 1925, pp. 21-24. *Radio-Frequency*  
 "The One-Stage Radio-Frequency Amplifier," P. L. Pendleton.  
 While designing a one stage radio-frequency amplifier, results of a nature different to the conventional, were obtained. They pertained to the control of oscillations in the radio frequency circuit over the broadcast band of frequencies. With the layout of Fig. 1 (circuit diagram Fig. 2), and the array of coils shown in Fig. 3, considerable information was gathered on the actual operation of such a setup. The final arrangement adopted as giving the best results, is shown in Fig. 4.





**FREE!**

To Each Purchaser of a **WORLD** 6-v. Auto or Radio **BATTERY**

**12-Cell — 24-Volt Storage 'B' Battery**

Positively given free with each purchase of a WORLD "A" Storage Battery. You must send this ad with your order. WORLD Batteries are famous for their guaranteed quality and service. Backed by years of successful manufacture and thousands of satisfied users. Equipped with Solid Rubber Case, an insurance against acid and leakage. You save 50 per cent and get a **2-Year Guarantee** ★

**Bond in Writing** WORLD Battery "tell their friends." That's our best proof of performance. Send your order in today.

**Solid Rubber Case Radio Batteries**

6-Volt, 100-Amperes . . . . .	\$11.25
6-Volt, 120-Amperes . . . . .	13.25
6-Volt, 140-Amperes . . . . .	14.00

**Solid Rubber Case Auto Batteries**

6-Volt, 11-Plate . . . . .	\$11.25
6-Volt, 13-Plate . . . . .	13.25
12-Volt, 7-Plate . . . . .	16.00

**Send No Money** Just state battery wanted and we will ship day order is received, by Express C. O. D. subject to your examination on arrival. **FREE "B" Battery** included. **Extra Offer:** 5 per cent discount for cash in full with order. Buy now and get a guaranteed battery at 50 per cent saving to you.

**WORLD BATTERY COMPANY**  
1219 So. Wabash Ave., Dept. 24 CHICAGO, ILL.

**World STORAGE BATTERIES**

Set your Radio Dials at 210 meters for the new 1000 watt World Storage Battery Station, WSHC, Chicago. Watch for announcements.

KDKA • WEA • WGN • WJZ • KJH • KGO • KFA • WLV • KOL

Why not subscribe to *Radio Broadcast*? By the year only \$4.00; or two years, \$6.00, saving \$2.40. Send direct to Doubleday, Page & Company, Garden City, New York.

**HOYT** "SUPER" CONTROL METER



FOR PRECISION CONTROL of Radiola Superheterodynes Nos. 20, 25 and 28

Instantly attached without any change in wiring to jacks already installed for this purpose. Permits setting rheostat for exact filament voltage for best reception and longest tube life.

A HOYT moving-coil voltmeter, type 17, with bronze rim, wood case to match set, non-scratch base and cord.

**Price \$8.50** ★

**BURTON-ROGERS CO.**  
26 Brighton Ave., Boston, Mass.

"The enchantment of distance, the joy of clearness, with **FROST-FONES**"

# New! Better!

Two useful new items of **FROST-RADIO** now ready

## A new **FROST-RADIO** socket that fits all new type tubes



This new socket takes ALL tubes with the new type bases. Has perfect spring construction which grips each tube prong full length with self-cleaning, sliding contact. We believe this socket to have the most satisfactory contacts of any socket made. All terminals plainly marked. It is equipped with soldering lugs. Genuine black Bakelite in high lustre finish. Order from your dealer today.

**FROST-RADIO**  
No. 530 **FROST-RADIO** SOCKET . . . 40c

## Convert your present standard sockets to UX199—CX299, or UX120—CX220 with this adapter



With this handy, inexpensive adapter you can instantly fit the new CX299 or UX199, and the CX220 or the UX120, into your present standard base sockets.

No need to rebuild your set to take the new tubes. Genuine black Bakelite—high lustre finish. Ask your dealer to supply you.

**FROST-RADIO**  
No. 540 **FROST-RADIO** ADAPTER . . . 25c

# HERBERT H. FROST, Inc.

314-324 WEST SUPERIOR STREET, CHICAGO  
NEW YORK CITY CLEVELAND KANSAS CITY LOS ANGELES

Export Office: 314 West Superior Street, Chicago

**I**F you like this magazine with its coated paper and enlarged size—then why not subscribe and get it regularly—by the year, \$4.00, Six months, \$2.00.

Doubleday, Page & Co.  
Garden City New York

RADIO FANS, a one-year's subscription to Radio Broadcast will cost you four dollars, two years six dollars. Consider this expenditure as being a necessary investment on your part for the future development of your own knowledge of Radio.

# Big FREE RADIO

**PARTS, HOOK-UPS, SETS and KITS** Catalog & Guide

Send now for this valuable FREE book. Full of advanced hook-ups, parts and kits. A real guide. Shows factory built sets and the new ideas in radio. Send at once. No charge. No obligation. Please include name of radio fan.

**BARAWIK CO.**  
102-109 S. Canal St., Chicago

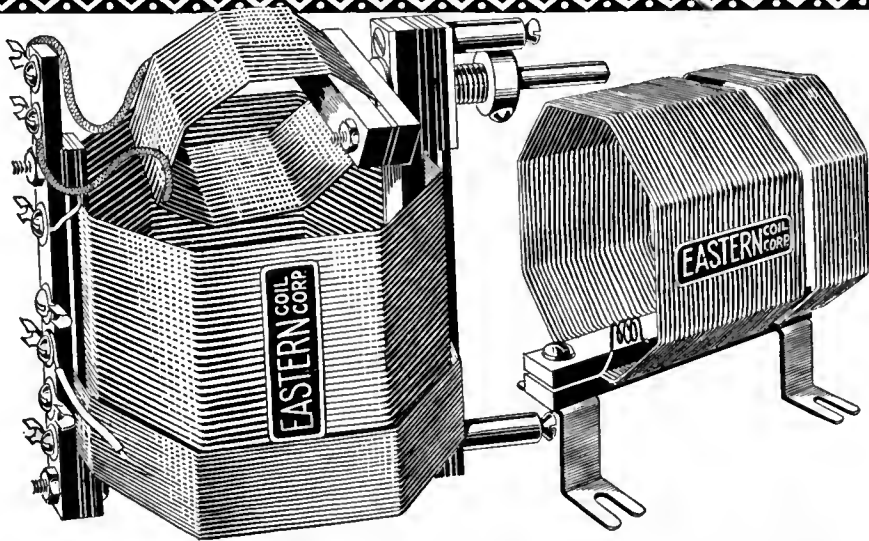

# EASTERN KNOCKOUT COILS (TYPE R)

Specified  
by  
RADIO  
BROADCAST  
for the  
"Aristocrat"  
Set

for the EASTERN KNOCKOUT CIRCUIT (The original unreflexed ROBERTS.)

Designed in strict accordance with latest Radio Broadcast specifications and guaranteed perfect for the "Aristocrat" and for all Roberts Knockout Circuits.

Minimum of capacity between N. P. winding and secondary; mid-tap on single-layer wound N. P. coil—simplifies neutralization and tuning, and brings in the lower wave length stations with a heretofore unequalled efficiency.

Price, \$8.50 per set.

## EASTERN Pickle Bottle COILS

TRADE MARK

Ever Increasing in Popularity

No matter what the circuit, they guarantee the best possible results from it because they incorporate every feature essential to low loss coil design, in conformity with every known radio engineering principle.

Highest inductance, combined with lowest distributed capacity and dielectric losses, least insulating material in the field, wires free of **any injurious substance—no celluloid or collodion binders used.** These are some of the advantages of this extremely efficient pickle bottle form of winding.

Elimination of losses keeps the high frequency resistance at the minimum, insuring increased selectivity, volume, and natural tone quality.

### Eastern Pickle Bottle Coils

may also be had for the following popular and leading circuits—

"EASTERN CLASSIC" circuit, the latest achievement in non-regenerative, efficient tuned R. F. reception—makes the ideal five-tube set. Hook-up free on request.

EASTERN CLASSIC COILS (Type EA, for use with .0005 condensers), set of 3.....\$6.00

EASTERN CLASSIC COILS (Type EB, for use with .00035 condensers), set of 3.....\$6.00

BROWNING-DRAKE (Type B-D).....\$8.00

THREE CIRCUIT (Type 3 C).....\$6.00

M. B. SLEEPER RX-1.....\$6.00

DX SUPERDYNE (Type S).....\$8.00

At your dealers or direct postpaid

## EASTERN COIL CORPORATION

22 Warren Street

Dept. R. B.

New York

This is a good time to subscribe for

### RADIO BROADCAST

Through your dealer or direct, by the year only \$4.00

DOUBLEDAY, PAGE & CO. GARDEN CITY, NEW YORK

## RADIO AGENTS WANTED

You Can Now Earn a

5 Tube Demonstrator FREE!



In addition to \$25 to \$100 a week, part or full time. Everyone a prospect. Complete line standard sets and accessories. \$5 to \$90. Write today for illustrated catalog and exclusive selling plan for live dealers and community agents. 20TH CENTURY RADIO CO., 1045 Coca Cola Bldg., Kansas City, Mo.

## If Your Set Won't Percolate

write us about it. RADIO BROADCAST is establishing a special repair department to assist set builders in getting the best out of the receivers they build from plans published in the magazine. Write for complete information about this new department established for your benefit.

R386. FILTERS. FILTERS, Key-Thump. *QST*, Nov. 1925, pp. 31-32. "Key-Thump Filters," Practical suggestions on where to and where not to connect a key in a transmitter to avoid key-thumps, are presented. Six possible locations for a key are shown in Fig. 7. Only one of these locations is good. The cure for key-thumps is found in a proper filter circuit. Analysis of various filters brings the author to the best possible arrangement of parts, shown diagrammatically in Fig. 5.

R350. GENERATING APPARATUS. TRANSMITTING SETS. KLUTH SYSTEM.

*Radio News*, Nov. 1925, pp. 601ff. "Plastic Radio by the Kluth System," Dr. A. Gradenwitz.

A method used for producing stereophonic effects at the receiving station is described. By means of a special high inductance variometer, two circuits are so arranged that the telephone current of one is slightly out of phase with that of the other, thus producing different acoustic effects, and giving a perfect plastic impression. Circuit diagrams are shown and described.

R343. ELECTRON TUBE RECEIVING SETS. RECEIVERS.

*RADIO BROADCAST*, Nov. 1925, pp. 36-40.

"A Model 1926 Broadcast Receiver," M. Silver. The receiver described by Mr. Silver has, for its fundamental requirement, wavelength flexibility. By using interchangeable coils a much larger frequency band can be covered. The matter of condenser size, regeneration, amplification, assembly, and testing, is covered in great detail. A list of parts required to construct the set is given. The receiver has three control dials, although, as explained, single control is possible by belting condensers together.

R610. EQUIPMENT; STATION DESCRIPTIONS. STATIONS.

*RADIO BROADCAST*, Nov. 1925, pp. 41-44.

"Radio Central-Conqueror of Time and Distance," F. J. Turner.

A graphic description of "Radio Central," the largest telegraph transmitting station in the world, is given. This station is located on Long Island, was built in 1920, and is owned by the Radio Corporation of America. It carries on transmission with all foreign countries, handling commercial messages throughout the year, twenty-four hours per day. Photographs show the immense towers and the station proper, interior and exterior.

R540. PRIVATE STATIONS. STATIONS. Private

*RADIO BROADCAST*, Nov. 1925, pp. 54-56.

"What Do We Know About Short Waves?" K. Henney.

The experimental short-wave station operated by *RADIO BROADCAST*, call letters 2 GV, is conducting experimental work to determine the results of short waves versus distance, using different values of power input. The station desires to cooperate with other experimenters in its efforts to arrive at some conclusion regarding some of these high frequency wave problems.

R343.7. ALTERNATING CURRENT SUPPLY. A.C. RECEIVER AND AMPLIFIER.

*RADIO BROADCAST*, Nov. 1925, pp. 57-62.

"An A. C. Receiver and Power Amplifier," J. Millen.

The design and assembly of a four-tube receiver using a.c. power supply, is given. A new high efficiency power amplifier is developed for use in the audio stages. Care in choosing parts for this set, especially for the power amplifier, is considered important. The construction of a power unit to supply B current from a 60 cycle source is detailed, giving circuit diagram and a list of parts. Considerable valuable information concerning the use of tubes in a.c. circuits is found in this article.

R570. DISTANT CONTROL BY RADIO. AUTOMOBILE, Radio-Controlled

*Radio News*, Nov. 1925, pp. 592 ff. "Radio-Controlled Automobile," H. Green.

By means of two 10-watt transmitters, an automobile was controlled up Fifth Avenue, New York City, the operator following some few hundred feet in another car. The controlling mechanism operated everything necessary in starting and running a car. Two frequencies were used, one to set the selector switch, the other to close the relays for the battery current. The wiring diagram shows the method used, photographs of the cars and the transmitters are also shown.

R545. AMATEUR RADIO. AMATEUR REC. & TRANS.

*Radio News*, Nov. 1925, pp. 605ff.

"A Crack 40-80 Meter Set," E. W. Thatcher.

The construction and operation of a simple but efficient transmitter and receiver, to operate round about 7500 kc. (37-43 meters) and 3750 kc. (75-86 meters), is described. According to the diagram, one 50-watt tube is connected in the Meissner circuit for transmission purposes. Both receiver and transmitter are considered in detail for the benefit of those who have had very little experience in the construction of radio sets. A table, showing the relative merits of the various wave-bands assigned to the amateurs, is given.

R343. ELECTRON TUBE RECEIVING SETS. RECEIVER, Two-Range.

*Radio News*, Nov. 1925, pp. 610-611. "A New Two-Range Receiver," S. Harris.

A receiver is described, using tuned inductances, capable of covering a range from 500 to 2000 kc. (600 to 150 meters). A single lever changes the inductances of each coil through a switch arrangement. This is a five tube set; two radio-frequency amplifiers, detector, and two audio frequency stages. Three tuning controls are required. Photographs are shown, giving constructional details.

R375. DETECTORS AND RECTIFIERS. RECTIFIER, Raytheon.

*Radio News*, Nov. 1925, pp. 613ff. "The Raytheon Rectifier," J. Riley.

The theory and characteristics of a new rectifier tube used in B battery eliminators is presented. Helium gas is used in this rectifier. It differs from other rectifier tubes mainly in the means taken to reduce the effective anode area, and in the selection of design for insuring steadiness of action. Two anodes are contained in the tube, the circuit diagram showing how this rectifier is connected to rectify both halves of the wave.



To-day-in every good set

**Less wiring— Fewer losses**

Full, clear, rich tone depends on more than on just good apparatus. It depends, first of all, upon careful, compact wiring. AMPERITE eliminates complicated wiring, avoiding leaks and losses. Requires no attention. Controls the filament perfectly, bringing the utmost out of each individual tube. Permits use of any tube or combination of tubes. Used in all popular construction sets. Price, \$1.10.

There is an AMPERITE for every tube

Write for free hook-ups ★

**Radiall Company**

Dept. R.B-2 50 Franklin St., N. Y. City

**AMPERITE**  
REG. U.S. PAT. OFF.  
The "SELF-ADJUSTING" Rheostat

**RADIO PANELS**

OF GENUINE BAKELITE

Cut, drilled and engraved to order. Send rough sketch for estimate. Our New Catalog on Panels, Tubes and Rods—all of genuine Bakelite—mailed on request.

STARRETT MFG. CO. ★

521 S. Green Street Chicago, Ill.

**RADIO BROADCAST**

For March

will be a better magazine than this. Make sure of it by telling your newsdealer to hold one for you—or better still, subscribe through him or direct.

**RADIO BROADCAST**

Garden City

New York

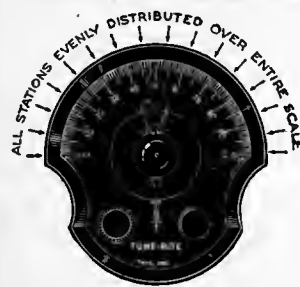

N  
O  
W

**Complete Separation of Low Wave Stations**

Perfectly accomplished with Tune-Rite, the straight line frequency dial. A marvel in scientific construction, it instantly converts any set to straight line frequency. Bring your present set up-to-date by replacing your old dials with Tune-Rite. Beautiful in appearance. Easily mounted without drilling.

Price, \$3.50

Write for instructions ★

**Radiall Company**

Dept. T.R.B.-1, 50 Franklin St., N. Y.

**TUNE-RITE**

The Straight Line Frequency Dial

Made by the makers of Amperite, the Self-Adjusting Rheostat



**"Now We Can Enjoy Radio"**

"WE NEVER knew what joy and entertainment radio could bring into the home until we bought our Mu-Rad. Now, with a slight movement of the Single Dial we can tune in any station that is broadcasting, so clear that it seems the music and artists are right here in our home. It is a comfort to me during the day and a relaxation to you after a busy day at the office."

The **MU-RAD** Transcontinental Receiver

can bring joy and entertainment into YOUR home. Ask your nearest dealer for a demonstration of this wonderful Radio—in your home.



Write for Booklet E-6

**MU-RAD RADIO CORPORATION**  
Asbury Park, N. J.

This is a good time to subscribe for

**RADIO BROADCAST**

Through your dealer or direct, by the year only \$4.00

Doubleday, Page & Company

Garden City, New York



TRADE MARK REG.

Above types in copper—tinned copper—enameled copper—tinned bronze.

Loop wires in silk or cotton covered.

Litz wires.

Enameled wires.

**RADIO WIRES**

We manufacture all types.

Round braided antenna wires

Flat braided antenna wires

Round stranded antenna wires

Antenna supporting springs.

Cotton and silk covered wires for set wiring.

Write us for descriptive catalogue.

**ROSS WIRE COMPANY**

69 Bath St., Providence, R. I.



## -it's in the Tube

A receiving set is no better than its tubes.

With other parts and connections *right* a set may be as good as its tubes—no set can be better.

That's why you want CECO Tubes. They stand up and deliver. With them your set works at its maximum. Clarity of tone, rich volume, long life—CECO has them all to a superlative degree.

Our charted tests (results confirmed by laboratories of national reputation) PROVE CECO TUBE SUPERIORITY—whether used as detectors, audio or radio frequency amplifiers.

CECO Tubes make a Good Receiver BETTER. Try them and you'll BUY them always—for results.

*Now Ready!* CECO Tubes with new type Long PRONG BASES. Also, Power Amplifier Tubes, E (Dry Cell Type), F (Storage Battery), for last stage of Audio Frequency.

Dealers write giving jobber's name.

C. E. Mfg. Co., Inc.

702 Eddy Street, Providence, R. I.

# CECO TUBES

Why not subscribe to *Radio Broadcast*? By the year only \$4.00; or two years, \$6.00, saving \$2.40. Send direct to Doubleday, Page & Company, Garden City, New York.

**RADIO RENCH**  
Five strong little wrenches and a handy screw-driver fitting every nut and bolt on your radio. All held together by a patented device so none will be lost but easily detached for use.

Niagara Metal Stamping Corporation  
Niagara Falls, N. Y.  
Folder 501 Free

**PREMAX** ★

15¢

Send Postal Note  
Prepaid if out of  
your district.

## If Your Set Won't Percolate

write us about it. RADIO BROADCAST is establishing a special repair department to assist set builders in getting the best out of the receivers they build from plans published in the magazine. Write for complete information about this new department established for your benefit.

R343. ELECTRON TUBE RECEIVING SETS. RECEIVERS. RADIO BROADCAST. Nov. 1925, pp. 28-31. "The Radio Broadcast 'Aristocrat,'" A. H. Lynch. The author describes in detail the construction and operation of a five-tube receiver having one stage of radio frequency amplification, regenerative detection, and three stages of resistance coupling. The circuit diagram, with list of parts, is reviewed to cover many kinds of radio parts now available. According to the author care should be exercised in mounting resistances for amplifier to prevent leakages. Photographs of several five-tube receivers, including the Radio Broadcast "Aristocrat," are shown.

R620.065. REGULATION AND CONTROL. CRYSTAL CONTROL. QST. Nov. 1925, pp. 8-13. "Crystal Control for Amateur Transmitters," John M. Clayton.

Rochelle crystals, when placed between two charged metal plates, change in shape. The fact, however, that they absorb moisture readily makes their use impracticable for the purpose here designated. Quartz crystals are far more satisfactory. Because of their electrical properties, crystals will oscillate when placed between two metal plates which are charged. A discussion concerning the axes of crystals and method of cutting and grinding them, follows. Ready cut crystals may be purchased from optical companies. Their use in practical circuits, precautions to observe, and results that can be obtained, are outlined in detail.

R350. GENERATING APPARATUS; TRANSMITTER, TRANSMITTING SETS. QST. Nov. 1925, pp. 26-30. "The Pacific Coast Standard-Frequency Station," H. H. Henline.

A complete description of the two standard-frequency stations located at Stanford University, California, 6x8M, is given. A circuit diagram of the 125-1500 kc. set, with a detailed list of parts and construction data of coils, etc., make possible the duplication of such a transmitter by experimenters. The 1500-6000 kc. set is simpler in construction, as indicated in the accompanying figure. A list of parts is also given.

R800. (533.85) VACUUM APPARATUS. TUBES, Gas Filled. Radio News. Nov. 1925, pp. 604 ff. "Hot Cathode Metal Vapor Tubes," Dr. C. B. Bazzoni. It is desired to obtain a detector tube with a sensitivity so high that regeneration, with its complications, will not be necessary. For this purpose, tubes employing ionization are considered as being much better than pure electron discharge tubes. The use of metal vapors is therefore tried and found superior to gas vapors for this purpose. The author describes how tubes are filled, and what results one can expect when connecting such a vapor filled tube into a receiving circuit.

R800 (534) SOUND RECORDING. SOUND PHOTOGRAPHS. Radio News. Nov. 1925, pp. 614 ff. "Sound Photographs and Their Reproduction," T. H. Nakken.

A method of recording and reproducing sound waves on a film, by means of a special tube called the Gehrke tube, is described. Two types of records may be made, one called by the writer the qualitative (step-ladder) type, the other the quantitative (saw-tooth) type. The latter is considered to be the better from several standpoints. Different types of microphones used to convert sound waves to electric energy are also mentioned in the discussion. A circuit diagram of a special amplifier for the weak currents is shown and explained.

R343. ELECTRON TUBE RECEIVING SETS. RECEIVER, Counterphase. Radio News. Nov. 1925, pp. 616-617. "The Counterphase Circuit," J. T. Carlton. The much discussed "Counterphase" circuit, having three stages of radio frequency amplification but only two controls, has many advantages over ordinary radio frequency sets, says the writer. First, the causes of oscillation in sets is taken up, then the principle embodied in this circuit is explained. Of particular interest seems to be the fact that no kind of losses are introduced in the grid circuit, which remains at a low resistance. Circuit diagrams and photographs are shown.

R342.7. AUDIO-FREQUENCY AMPLIFIERS. AMPLIFIERS, Audio-Frequency. Radio News. Nov. 1925, pp. 620-623. "The Four Types of Audio Amplifiers," S. Harris. In receiving sets of today four types of audio amplifiers are in common use, namely transformer, impedance, resistance, and push-pull. Diagrams of these four types, with detailed discussion concerning use, characteristics, and advantages, are given. A breadboard layout of each type is also shown. Comparison by the author shows some interesting results concerning the particular type of amplification method to be used, especially in the many kinds of receiving sets now being constructed. Each amplifier arrangement has its specific advantages.

## First International Meeting of Radio Engineers

FOR the first time in the history of radio, the scientists and engineers who made radio telegraphy and radio broadcasting a reality will convene in an International Meeting and Convention in New York City, January 18th and 19th. Notices have been sent by the Institute of Radio Engineers, under whose auspices the meetings are being held, to its members both here and abroad. Included in its membership roll are such illustrious names as Guglielmo Marconi, Edwin H. Armstrong, Louis A. Hazeltine, E. F. W. Alexander, George O. Squier, Lee de Forest, Thomas A. Edison, Michael Pupin, Irving Langmuir, Reginald Fessenden, John Stone, David Sarnoff, and John V. L. Hogan.

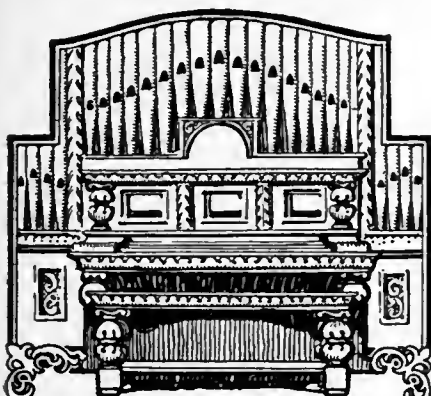

**“Even the organ crescendo was perfect”**

A VETERAN set-builder recently remarked about the purity of tone at tremendous volumes that he got through the Super-size Precise No. 480 Audio Transformer. In particular was he impressed with a recent organ recital which he had received. “Why,” he said, “even the organ crescendo was perfect.”

The big Precise No. 480 (shown below) is truly a master transformer, designed for radio reception in a concert hall if necessary. It brings forth the deep rich tones or the high clear tones with magnificent volume. The ratio of voltage amplification to frequency is practically a straight line, assuring uniform amplification over the entire range of useful audio frequencies.

Made in two ratios, 2½ to 1 and 5 to 1.

Price, \$7.50 either ratio.

Ask your nearest radio dealer to show you the complete Precise Line.

**PRECISE MANUFACTURING CORPORATION**

Rochester, N. Y.

Branch Offices:

126 Liberty Street New York City	1127 Pine Street St. Louis, Mo.
205 W. Harrison Street Chicago, Illinois	701 A. D. U. W. Bldg. Little Rock, Ark.
821 Market Street San Francisco, Cal.	454 Builder's Exch. Minneapolis, Minn.

Canadian Distributor: Perkins Electric, Ltd.  
Toronto, Winnipeg, Montreal

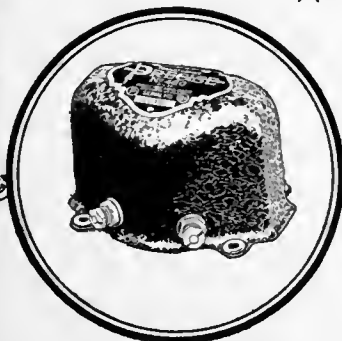

## Improved S. L. F. Condenser \$2.75

A scientific instrument house of international reputation offers for the first time direct to the radio fan an improved S.L.F. Variable Air Dielectric Condenser.

Due to over production on orders from prominent set manufacturers whom we have been supplying for years!

Type offered has a maximum capacity of 315 M. M. F. with a minimum of 8 M. M. F. especially adapted to Neutrodyne, Tuned Radio Frequency, and Radio Broadcast Hook-Ups for home construction.

Made of the best materials obtainable, of highest grade aluminum and brass; workmanship that of precision instrument maker!



Ordinary “Straight line frequency” calibration gives too rapid a capacity variation near maximum capacity to permit convenient tuning for the longer wave lengths. Radio Engineers will appreciate the nicely balanced compromise we have obtained in equal spacing broadcasting stations and equal facilities of tuning over the entire frequency band. Compact; no narrow pointed rotor plates of small area to crowd the other parts of the set, but eccentric semi-circular plates of adequate area.

The low minimum capacity (7 to 8 micro-microfarads) reaching down to 200 meters, necessary for new Department of Commerce allocations.

Losses are negligible.

The bearings are individually reamed to fit, with no side or end play and are mechanically correct with dissimilar metals on all rubbing surfaces.

Good electrical bonding between plates, due to our highly developed crimping process. Good centering of plates, resulting from high standards in assembly and adjustment and rigid inspection and test.

General sturdiness of construction and cleanness of workmanship.

Due to our large production for set manufacturers, we are enabled to offer extremely reasonable prices on these high grade condensers.

Sold only on a cash with order basis, money returned if you are not more than satisfied that they are exactly what you want and none equalled electrically or mechanically.

Price \$2.75 each. Set of three, \$8.00

Sent by paid parcel post anywhere in U. S. A.

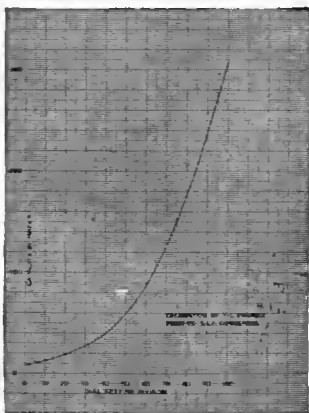

## THOMPSON-LEVERING COMPANY

RADIO DIVISION



353-357

North 57th Street

Philadelphia, Pa.,  
U. S. A.

Trade Mark Registered

## At Last! A Real Panel Engraving Machine at a Price you can afford.

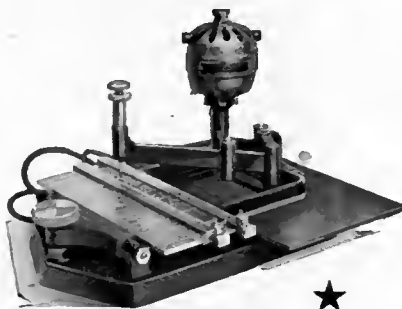

Capacity 14 x 40”

LOW in price because it is designed for panel engraving only.

For engraving your own Panels, or panels for others with any marking desired, including Trade-marks, special designs and serial numbers.

Being designed particularly for panel engraving, it is the most rapid and accurate machine for engraving panels. Simple to operate.

Price of machine with full equipment including master letters and characters, \$135.00.

f. o. b., Forestdale, R. I.

Wire or write

BRANCH TOOL CO., Dept. G  
Forestdale, Rhode Island



# Centralab Radiohm

*for oscillation control*

The Centralab Radiohm gives you perfect oscillation control—enables you to get full efficiency from your radio set.

By controlling oscillation with this little unit, you can hold that sensitive regenerative position which immediately precedes the oscillation point, without distortion or loss of selectivity. Think what a boon to clear, true-tone reception this is!

The Radiohm provides smooth variation of resistance from zero to 200,000 ohms. Ideal for plate circuit control of oscillation. Used as a standard unit in many leading commercial sets. Price: \$2.00.

# Centralab Modulator

*for volume control*

This improved type of potentiometer takes the "rough spots" out of volume—smooths out powerful "locals" as well as difficult "DX." It provides noiseless control of tone volume without in any way affecting the tuning of your set. Has a maximum resistance of 500,000 ohms, specially tapered to give smooth, even control from a whisper to full volume—or vice versa—without de-tuning.

Used in the "Silver Six" set! also in audio circuits with any transformers or with Thordarson "Autoformers." Price: \$2.00.

**CENTRAL RADIO LABORATORIES**  
22 Keefe Avenue Milwaukee, Wis.

*Mail the coupon*



**CENTRAL RADIO LABORATORIES** 22 Keefe Ave., Milwaukee, Wis.  
( ) Send me literature describing Centralab controls. Enclosed find \$..... for which please send me the following:  
( ) Centralab Modulator, at \$2.00 each. ( ) Centralab Radiohm, at \$2.00 each.  
Name .....  
Address .....



## BOOK REVIEW

### The Economic Background of Radio

**ECONOMICS OF THE RADIO INDUSTRY.**  
By Hiram L. Jome, Ph. D. Published by A.W. Shaw Company, New York, Chicago, and London. 332 pages. \$5.

**T**HIS work by the Professor of Economics at Denison University is said by the publishers to be the pioneer book on the subject. It is a good beginning, and marks a transition from the state of affairs which was epitomized, about six years ago, by a prominent electrical manufacturing executive called on to manufacture radio telegraph equipment. "Radio isn't a business!" cried this gentleman in a moment of confessional anguish, "It's a disease!" What is more, at the time he said this he was right, as he was also when he declared vacuum tube manufacture to be "a nice toy for the lamp works." But times change. In 1924 the tube business alone, according to Mr. Babson, amounted to about \$50,000,000, which is a good-sized toy for anyone. In fact, it was able to swallow a few dozen lamp works as an entrée.

*Economics of the Radio Industry* is written in four parts, with an appendix. Part I, concerned with "Development and Extent of the Radio Service," is largely a technical and financial history of the whole wireless art, both telegraphy and telephony, from the days when the coherer was a great and indispensable invention, down to this era of super-heterodyne and balanced radio frequency receivers calibrated in kilocycles, receiving antennas nine miles long, transmitters which put one thousand-plus amperes into antenna systems which in themselves constitute engineering feats, and radio technicians who are engineers, telephone experts, publicists, musicians, and diplomats, all in one. The four chapter headings in this part of the book give some idea of the range covered: "Beginnings of Wireless"; "Early Organization for Service"; "The Radio Corporation of America"; "The Radio Industry of To-Day."

Part II, under the somewhat vague heading of "Bringing Radio Service to the People," is principally a discussion of marketing, retailing, and financing problems in receiving set manufacture, but at the end there is a chapter on "Handling of Traffic", which includes an elementary discussion of oscillation and vacuum tube theory, preliminary to an analysis of traffic conditions in long distance radio telegraphy.

In Part III, "Problems of Efficiency in Radio Service," the growing pains of broadcasting, copyright and patents as property problems in the radio field, and the extent to which sound public policy requires federal and international control of the various services, receive about seventy-five pages of discussion. This is followed by Part IV, "The Future of Radio," in which the author cautiously ventures into the domain of prophecy, having in mind the rash remark (which he quotes) of Mr. Marconi's youth: "As soon as my wireless system succeeds, the vast network of cables and wires will become useless, and the money invested in the old system will be simply thrown away," a forecast which has turned out to be so incorrect that it should evermore serve as a warning to even the greatest inventors, sales "engineers", and promoters. The wireless system has succeeded, and there are more wires and cables than ever. But Dr. Jome plays safe, and in gazing into

### 400 CENTS RESISTANCE

is the subscription price to Radio Broadcast for one year. This is less than the cost of a good low loss variable condenser. Let us enter your subscription to begin with the next issue.

Send \$4.00 with your name and address to Radio Broadcast, Garden City, N. Y.

*This is a good time to subscribe for*  
**RADIO BROADCAST**  
Through your dealer or direct, by the year only \$4.00  
**DOUBLEDAY, PAGE & CO. GARDEN CITY, NEW YORK**

**RADIO CATALOG**  
**DEALERS!**  
Send for our big new live Catalog. Contains hundreds of standard nationally advertised sets, kits and parts.  
Use your letterhead  
**Western Radio Co. MFG**  
134-136 W. Lake St. Chicago, Ill.

# REMEMBER!

WHEN BUILDING THE ROBERTS' KNOCK-OUT AND ARISTOCRAT



Receivers that CLAROTUNERS are easier to mount, easier to hook-up, and that a more even approach to the point of MAXIMUM AMPLIFICATION is effected with CLAROTUNERS.

## DO YOU KNOW

that CLAROSTAT is the perfect variable resistor and that it is the only logical resistor for the UNIVERSAL receiver?



Send Stamp for Hook-ups

American Mechanical Labs., Inc. ★

285 North Sixth Street  
Brooklyn, New York

## Antiques

interiors, houses, gardens, travel, sports, horses, dogs, blooded cattle—

all these are in

## Country Life

A Doubleday, Page Magazine  
Limited Supply at Newsstands

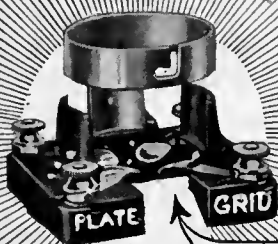

"It gets that last mile"

SEE THAT GAP

## The AIRGAP SOCKET THE BEST TEST

Listen in on your detector, replace old socket with an AIRGAP SOCKET. Note the wonderful improvement. You will then use no other.

Sent direct if your dealer cannot supply you. 75 cents each. ★

AIRGAP PRODUCTS CO. MFR.  
188 N. J. R. R. Ave. Newark, N. J.  
"Yes, It's Bakelite"

# Superadio Receiver

5  
Tubes  
—  
2  
Dials



Licensed Under Reactodyne Agreement

Many New Features

\$56

MATCHLESS tone quality is obtained in the Superadio Receiver due to the Reactodyne System of R. F. Amplification by which automatic control of oscillation is effected over the broadcast range. As the result of exhaustive development work, each tube performs the maximum amount of work assuring greater volume and greater distance. Housed in a handsome, compact, solid walnut cabinet with black bakelite panel, engraving in deep gold. Very easy to operate. Economical upkeep. Truly marvelous results.

Ask your dealer or write us

# Superadio Dynamometer



Superadio Dynamometer equipped with phones and plug. Price \$120. (Patents Pending)

Remember—you can now buy TESTED tubes—where the Superadio Dynamometer is on the job. This meter is direct reading. Measures Amplification Factor, Plate Impedance and Mutual Conductance of any tube. No Curves—No Calculations.

Jobbers and dealers

The Superadio is direct reading and tests 3 tubes per minute. Write for discounts.

SPECIAL MODEL S-2 AMPLIFIER \$30

To be used with Dynamometer and loud speaker in place of phones

Just out—The new Superadio B-Battery Eliminator.

## De WITT-La FRANCE CO., Inc. ★

54 Washburn Ave., Cambridge, Massachusetts

Boston Representative: Martin, Hartley & Dewitt Sales Co., 99 Bedford St.

Chicago Representative: William A. Welty & Co., 36 So. State St.

## LEARN THE CODE AT HOME with the OMNIGRAPH

"Just Listen—The Omnigraph will do the teaching!"



THE OMNIGRAPH Automatic Transmitter will teach you both the Wireless and Morse Codes—right in your own home—quickly, easily and inexpensively. Connected with Buzzer, Buzzer and Phones or to Sonnder, it will send you unlimited messages at any speed, from 5 to 50 words a minute.

★ THE OMNIGRAPH is not an experiment. For more than 15 years, it has been sold all over the world with a money back guarantee. The OMNIGRAPH is used by several Depts. of the U. S. Govt.—in fact, the Dept. of Commerce uses the OMNIGRAPH to test all applicants applying for a Radio license. The OMNIGRAPH has been successfully adopted by the leading Universities, Colleges and Radio Schools.

Send for FREE Catalogue describing three models. DO IT TO-DAY.

THE OMNIGRAPH MFG. CO., 13K Hudson St., New York City

If you own a Radio Phone set and don't know the code—you are missing most of the fun

Order your copy of *Radio Broadcast* from your news dealer or radio store. Make sure that he reserves a copy for you each month. If your favorite radio store does not stock the magazine write us giving name of radio dealer and address.

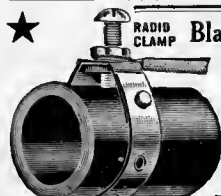

## Blackburn Ground Clamps

★ Telephone companies using MILLIONS. Adjustable—fits any size pipe. Requires no pipe cleaning—screw bores through rust and scale. Send 12 cents for sample and postage.

Blackburn Specialty Company  
1960 E. 66th St. Cleveland, O.

## Gosilco Super Aerials

Heavy burnished silver plate on 14 copper sheathed with 24 karat gold. Permanently efficient. O t-distance all others. Sets re-wired with Gosilco show 35% increase volume, range. K N X lab. test. Approved Popular Radio, Radio News All American Radio Corp. 4½¢ per ft., round bus wire 12¢ per length, po t-paid. C. O. D.

American Luminous Products Co. ★

Patent Applied for  
Huntington Park California

# You must protect the circuit against leaks and losses

## RADION

The Supreme Insulation  
*does it!* ★

**RADION** offers the *utmost possible protection* against leaks and losses. Designed exclusively for radio purposes, it is the most efficient insulation as indicated by authoritative, impartial tests. Radion Panels reduce surface leakage to a minimum. Their beautiful surface finish adds to the attractiveness of any set. Radion Dials match their beauty of fin-

ish and help to get close tuning. Radion Sockets eliminate capacity effects; they are made both for new UX tubes exclusively and with collar adapters for old-type tubes.

Radion dealers have the complete line of Radion low-loss parts. Manufacturers will find it to their interest to write us for prices on moulded parts. Send for catalog.

FREE Booklet, "Building Your Own Set" mailed on request

**AMERICAN HARD RUBBER COMPANY**

Dept. C 14, 11 Mercer Street, New York City. Chicago Office: Conway Building  
Pacific Coast Agent: — Goodyear Rubber Company, San Francisco—Portland

### RADIO STUDY AT HOME

**EXPERT**

Radio, the wonder of all ages, has grown with gigantic strides. Radio experts are needed to keep pace with the growth. Thousands of good-paying positions are open to trained men. file a radio expert—earn big money—travel—get into the limelight. There's romance, power and fortune ahead for men with vision now just as there was when Henry Ford got started on his auto. The ground-floor opportunity is here.

**YOU EARN WHILE YOU LEARN**

Our home-study course in practical radio can be mastered by you in 3 months. Become a radio engineer. Write for free booklet: "Millions Untouched." **PREP TWIN** if you enroll now. Send letter or postal to **RADIO RPT. I. J. Mendel**—how to make \$100 wk. **AMERICAN RADIO ENGINEERS, Dept. 18 Hearst Bldg., Chicago, U. S. A.**

### NO MORE LOOSE CONNECTIONS

#### X-L PUSH POST

A Binding Post that really does excel, looks, action, service and convenience. Push it down—insert wire—cannot jar loose from vibration. No screwing or danger of shearing off wires. Furnished attractively plated with soldering lug and necessary markings.

★ **Price Each, 15 Cents**

**X-L RADIO LABORATORIES**  
2424 Lincoln Ave. CHICAGO

**RADIO FANS**, a one-year's subscription to Radio Broadcast will cost you four dollars, two years six dollars. Consider this expenditure as being a necessary investment on your part for the future development of your own knowledge of Radio.

### FOR CLEAR, QUIET "B" POWER



**275** RADIO Storage "B" Battery

**12 Cells 24 Volts Lasts Indefinitely—Pays for Itself**

Economy and performance unheard of before. Recharged at a negligible cost. Delivers unflinching power that is clear, pure and quiet. Approved and listed as Standard by leading Radio Authorities, including Pop. Radio Laboratories, Pop. Sci. Inst. Standards, Radio News Lab., Lefax, Inc., and other important institutions. Equipped with Solid Rubber Case, an insurance against acid and leakage. Extra heavy—1 1/2 jars. Heavy rugged plates. Order yours today!

**SEND NO MONEY** Just state number of batteries wanted and we will ship day order is received. **Extra offer:** 4 batteries in series (96 volts), \$10.50. Pay exp. casman after examining batteries. 5 per cent discount for cash with order. Mail your order now!

**WORLD BATTERY COMPANY**  
1219 So. Wabash Ave., Dept. 24, Chicago, Ill.  
Makers of the Famous World Radio "A" Storage Battery  
Prices: 6-volt, 100 Amp. \$11.25; 120 Amp. \$13.25; 140 Amp. \$16.00.  
All equipped with Solid Rubber Case.

## World STORAGE BATTERIES

Set your Radio Dials at 210 meters for the new 1000 watt World Storage Battery Station, WSBG, Chicago. Watch for announcements.

KDKA = WEAF = WGN = WJS = KHJ = KGO = KFAP = WJY = KOL

the future he does not relinquish the sober and unpyrotechnical style with which he writes of the past. As to the future of broadcasting, he apparently favors a modification of the British system, combining the order and symmetry of the latter with some of the advantages of the American *laissez-faire* structure, which admittedly begins to lean at an alarming angle.

In preparation for writing this book Dr. Jome has very obviously talked to a great many people and consulted a raft of documents and authorities. There is scarcely a page without one or more footnote references. The author has done a thorough job at an opportune time, and his book deserves wide reading among people to whom radio is more than a song and dance. Leaving aside the advent of broadcasting, which brought up the gross sales of the Radio Corporation of America, for example, from \$1,468,920, or 35 per cent. of the total business, in 1921, to \$50,747, 202, or 92.5 per cent of the whole, in 1924, practically swamping, as far as magnitude goes, the communication activities of the company—even omitting consideration of this shift, the changes have been remarkable. In transoceanic communication, not much over ten years ago the practice was to build a line of 400-foot masts for reception—vacuum-tube amplifiers were not yet taken seriously—and large stone hotels were erected for the occupancy of operating staffs of sixty men or so off on the seashore somewhere. These men copied the messages and re-transmitted them over wire lines to the metropolis, adding another link to the chain with that much more chance of errors creeping in. A few years later this whole system was changed. None of the engineers of 1914—and they were good engineers—were able to foresee this development. In a business which turns such somersaults, there is certainly room for an economic treatise like that which Professor Jome has given us.

A few errors and omissions may be pointed out. On page 86 we encounter the statement that "Consumers now looked for apparatus which would enable them to tune-out a larger number of stations, thus eliminating interference and eliminating static." Doctor Carson has proved that sharp tuning will not eliminate or reduce static in any way, shape, or manner. The footnote on page 166, discussing the question of the pioneer broadcasting station, does not mention the later work of De Forest (in 1916) at High-bridge, New York. On page 167, Doctor Jome trustingly states it as his opinion that a large number of broadcasters "have begun the broadcasting game for no ulterior motive at all." So they say. Possibly Munchausen wasn't a liar either. Page 170: "The act of reception itself does not weaken radio signals, just as the human voice, carried by means of sound waves, can be heard by all within range without loss of strength." This is not true in the case of a number of receiving antennas close to each other and tuned to the same signal, and there is reason to believe that the field strength of a transmitter may be pulled down somewhat in urban reception by a great number of outdoor antennas tuned to it. On page 203, discussing the motives of Heinrich Hertz, the author of *Economics of the Radio Industry* fails to mention the most probable reason why Hertz omitted to take out a patent, to wit: that he wasn't interested in making money. And some of the aviators may be amused at the statement on page 235 about what damage an aviator flying far up above New York could do. If he went that high he would probably have all he could do to take care of himself. The high estimate of beam transmission (Page 269) is possibly somewhat too sweeping. And Professor R. A. Fessenden's name is not found in the index. Such little points can be corrected in later editions.

## DURHAM

### Variable Leaks

#### And Tube Makers Data

**Standard Type 75c**

Instruction sheets say that you should try different values. With a DURHAM this is done with a smooth running plunger. Fits your present clips.

#### New Panel Mount

Short lead to grid \$1 Note patent plunger

Durham convenience and accuracy brought to your fingertips. This type makes shortest path from socket to condenser or coil. Fits in 1/4" hole.

There's a DURHAM for every need

No. 100—1,000 to 100,000 ohms (audio)  
No. 101—0.1 to 5 megohms (for UV-200 and WD-12 tubes)  
No. 201A—2 to 10 megohms (for UV-199 or 201A tubes)

**DURHAM & CO., Inc.**  
1936 Market St., Philadelphia



**New Roberts' "Supercoils" using Capacity Feed Back**



Higher Amplification with Zero Coupling for "The Aristocrat" and "Universal"

Per Set Complete **\$7.00**  
P. P. C. O. D. if desired

Mail postcard for details



PERFECTION RADIO MFG. CO.  
24th & Race Streets Philadelphia, Pa.

A Laboratory Product

**CRESCENT LAVITE RESISTANCES**

for Distortionless Amplification

As transmitting Grid leaks, they are made in special sizes and are not afraid of power. Dissipate 10 watts. Four standard sizes \$1.50 each. Special resistances \$2.50 each.

Crescent Radio Supply Co. 1-3 Liberty St., Jamaica, N. Y.

**RUDYARD KIPLING**



Who is able to reach you, talk to you in your own language, portray your own emotion, convulse you with laughter or hold you spellbound before pathos or power . . . like Kipling? Buy his books.

AT ALL BOOKSTORES



**The Best in the World**

**No Batteries**

are required even to operate the most powerful 10-tube receiver pictured above, if you use the new laboratory type

**Model A Power Unit**

**One Customer Telegraphs:**

"Receiver assembled, performing like a thoroughbred."

The Amateur or Experimenter with his ultra-modern high-powered receiver is years ahead of Commercial Radio.

It is significant that unsolicited testimonials are constantly being received from even the far corners of the earth, where Norden-Hauck Engineers have furnished the finest radio apparatus known to the art today.

Quotations gladly furnished on radio parts and apparatus having non-infringing uses.

Write for Literature



**NORDEN-HAUCK, Inc.**

Engineers

1617 Chestnut Street, Philadelphia, Pa.

Why not subscribe to *Radio Broadcast*? By the year only \$4.00; or two years, \$6.00, saving \$2.40. Send direct to Doubleday, Page & Company, Garden City, New York.



**Radio Battery Chargers**

Best by Test



**\$8<sup>50</sup>** minus bulb

east of Rockies

Your dealer can get it for you

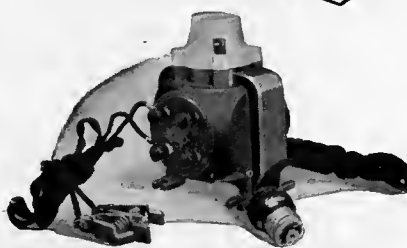

**THE ACME ELECTRIC & MFG. CO.**  
1410 Hamilton Avenue Cleveland, O.

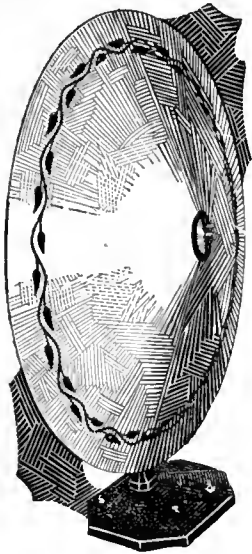

# Make Your Own Cone Loud Speaker —and Save \$25<sup>00</sup>

(All Parts Supplied)

Why pay \$35 for a cone loud speaker when you can easily assemble a splendid super-sensitive one at home with the complete parts we send you—and save \$25?

We include a special complete cone unit, blueprint and simplified directions for assembling. You can easily set up this wonderful speaker in a few interesting hours. Large size, stands eighteen inches high, complete in every detail. Not only unmatched for beauty but reproduces both music and voice with faultless accuracy. Yet the cost is amazingly low—only \$10 for the most approved form of speaker known. You make this big saving because we save the cost of assembling and packing and you save all jobbers' and dealers' profits.

**SEND NO MONEY**

Simply send name and address and the complete outfit will be sent you by return mail. When postman brings package, deposit with him only \$10.00 in full payment. If you aren't more than delighted—if you are not absolutely convinced that you have a cone speaker equally as fine as any \$35 cone sold—simply return the parts within ten days and your money will be instantly refunded. Never before has a better radio bargain been offered. You would pay at least \$35 for a cone speaker of equal quality anywhere. Act at once. Write NOW!

**SCIENTIFIC RADIO LABORATORIES** 254 West 34th Street, Dep't 22  
New York City

## WHAT OUR READERS WRITE

### Chain Broadcasting an Economy

**D**UE to the fact that we go to press a number of weeks before publication and to heavy demands upon our space, we have not been able to print this interesting letter which came to our desk some time before the last Washington Radio Conference. Those would-be broadcasters whose hopes were cast to the ground by the statement that very few more stations would be licensed, should consider the possibilities of the use of the chain system as an alternative to erecting their own stations. The following letter is representative of several we have received on this subject.

Editor, RADIO BROADCAST  
Doubleday, Page & Company,  
Garden City, New York.

SIR:

Permit me to call to your attention a field which your magazine might cover with advantage to the radio public. It is a campaign to educate the prospective broadcasting station builder into a realization of the fact that his yearnings for fame and publicity may be attained by means other than supplying the radio audiences with a quantity of programs such as are now available to all.

We have been discussing the question of who pays for broadcasting. That, of course, is easily answered, as easily as the question of who pays for the full pages of advertising in the *Saturday Evening Post* and our daily newspapers. Does broadcasting pay well? That question also is easily answered, for take note of the fact that we are to have about forty new Class B stations and that many of the older Class B stations are scrambling to double and triple their present power output.

Now the thing that puzzles me is why we, the radio listeners, need these 40 new stations when the air is so congested now that one can generally hear two programs on one wave channel to the accompaniment of a beautiful heterodyne whistle. To which wave channels will these new stations be assigned without increasing this annoying interference?

My suggestion is this. Educate the prospective broadcasting station builder into spending his money on good programs put on the air once or twice a week through a chain of stations such as are now connected with the American Telephone & Telegraph system. The simultaneous broadcasting from several stations of exceptionally fine programs is far better advertising and creates more good will than the continuous broadcasting of mediocre or poor programs such as we now have from many stations. More people would be reached and at the same time the cost of such fine programs, although expensive, would not equal the cost of equipping and maintaining a broadcasting station.

I firmly believe in interlinking broadcasting stations for indirect advertising by means of superfine programs of education and music. Such a system will force the other stations to produce equally fine programs or lose the good will of the radio public. Two very fine examples of indirect advertising by the system of chain broadcasting are the programs of the National Carbon Company and the Victor Talking Machine Company. Let us have more programs like these with fewer Class B stations using more power.

Yours very truly,  
F. L. W.,  
Philadelphia, Pennsylvania.



**ALMOST TOO GOOD TO BE TRUE  
X-L VARIO DENSERS**  
INSTALL THEM IN YOUR SET AND LEAVE  
THEM SPEAK FOR THEMSELVES

Endorsed and Used by the Foremost Radio Engineers

MODEL N—Capacity range 1.8 to 20 micro-microfarads, for balance in Roberts two tube, Browning-Drake, McMurdo Silver's 4-tube set, Neutrodyne and tuned radio frequency circuits. Price, \$1.00

MODEL G—For the Cockaday circuit, filter and intermediate frequency tuning in super-heterodyne and positive grid bias in all sets.

G-1—,00002 to ,0001 Mf. O-10—,0003 to ,001 Mf.

G-5—,0001 to ,0005 Mf.

Price each with Grid Leak Clips \$1.50

X-L RADIO LABORATORIES 2424 Lincoln Avenue, CHICAGO

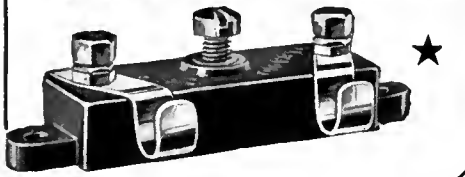

**WRITTEN 2-YEAR GUARANTEE**

**Battery Prices SMASHED!**

**To Consumers Only**  
Here is a real battery quality, guaranteed to you at prices that will astound the entire battery-buying public. Order Direct From Factory. Put the Dealer's Profit in your own pocket. You actually save much more than half, and so that you can be convinced of true quality and performance, we give a **Written 2-Year Guarantee**. Here is your protection! No need to take a chance. Our battery is right and the price is lowest ever made. Convince yourself. Read the prices!

<b>Auto Batteries</b>	<b>Radio Batteries</b>
6 Volt, 11 Plate, \$9.50	6 Volt, 100 Amp., \$9.50
6 Volt, 12 Plate, \$11.50	6 Volt, 120 Amp., \$11.50
12 Volt, 7 Plate, \$13.00	6 Volt, 140 Amp., \$13.00

**Buy Direct—Send No Money**  
We ask no deposit. Simply send name and address and style wanted. Battery will be shipped same day we receive your order Express C.O.D. subject to your examination on arrival. Our guarantee accompanies each battery. We allow 6% discount for cash in full with order. You cannot lose! Send your order today—NOW!

**ARROW BATTERY CO.**  
Dept. 10, 1215 So. Wabash Ave., Chicago

## Books by Telegraph between

New York

Cleveland

Kansas City

Springfield

Toledo

St. Louis

**Doubleday, Page  
Book Shop**

## FREE BLUE PRINTS To Set Builders

TO PROVE THE SELECTIVE AND SENSITIVE  
COMBINATIONS OBTAINABLE WITH

## Werner Transformers

(Radio Frequency Type)

which cover the entire broadcasting wave range and have been used by the best radio engineers for the past 2 years, we will furnish a full size Blue Print of a selective 6 tube Loop Receiver FREE if you order from us direct.

Werner Radio Frequency and Audio Frequency Transformers are fully guaranteed and tested, on actual broadcast reproduction. Guaranteed damp and moisture proof and will give perfect reception in any climate.

**MADE IN TWO TYPES**

Tuned and outfitted for any standard type of vacuum Tube  
Radio Frequency \$4. Audio Frequency \$6.

## Werner Loop Antenna

Used with any type of loop receiver. Adjustable to a fine degree of clearness. Can be folded or extended without tools. Approved by POPULAR RADIO.

**PRICE POSTPAID \$14.00**

Send for free circuit diagrams and descriptive literature.

Book of Up-to-date, practical R. F. circuit diagrams and treatise on R. F. amplification postpaid **25c**

Ask Your Radio Dealer

**WERNER MFG. CO.**

204 Ninth St. Brooklyn, N. Y.



**Oh boy!**

**KESTER**  
Rosin Core  
**Radio SOLDER**  
Sure is Safe and Simple

Approved by  
**Radio Engineers**  
A Genuine Solder

CHICAGO SOLDER COMPANY  
4222 Wrightwood Ave., Chicago, U. S. A.

Originators and  
World's Largest Manufacturers of  
Self Fluxing Solder

YOUR DEALER  
CAN SUPPLY YOU

22½ Volt  
un-acid  
everlasting  
rechargeable  
"B"

Storage Battery

**\$2.95**

includes  
chemical



45 volts \$5.25, 90  
volts \$10.00, 112½  
volts \$12.50, 135  
volts \$14.75, 157½  
volts \$18.80.

Truly the biggest buy today: Easily charged on any current includ-  
ing 32 volt systems. Any special detector plate voltage had. Tested  
and approved by leading authorities such as Popular Radio labora-  
tories. Over 3 years sold on a non-red tape 30 day trial offer with  
complete refund if not thoroughly satisfied. Further guaranteed 2  
years. Knock-down kits at greater savings. Complete "Hawley"  
"B" Battery Charger \$2.75. Sample cell 85c. Order direct—send no  
money—simply pay the expressman cost on delivery. Or write for  
my free literature, testimonials and guarantee. Same day shipments.

B. Hawley Smith, 312 Washington Ave., Danbury, Conn.

# Speed

## RADIO TUBES



SUPREME  
IN  
PERFORMANCE

The one outstanding Tube  
in radio betterment.



TYPE  
201-A

No station too distant for "SPEED"  
Tubes. They bring in voice and  
music as broadcasted.



TYPE  
12

The latest charted tests from Radio  
Broadcast Laboratories prove  
"SPEED" Tubes are superior in  
quality and performance. Send for  
a copy.



TYPE  
199



**CABLE SUPPLY CO.**  
INCORPORATED

Sales Offices

907 Broadway, New York City

# RADIO BROADCAST

ARTHUR H. LYNCH, Editor  
WILLIS K. WING, Associate Editor  
JOHN B. BRENNAN, Technical Editor

MARCH, 1926  
Vol. VIII, No. 5

## CONTENTS

Cover Design	- From a Painting by Fred J. Edgars	
Frontispiece	- - A Majestic English Radio Tower	546
A Man and His Hobby	- - - - E. E. Horine	547
The March of Radio	- - - - J. H. Morecroft	552
Can We Forecast Radio Reception from the Weather?	J. C. Jensen	558
What Multiple Regeneration Can Do For Your Tuned R. F. Amplifier	- - - - V. D. Landon	563
As the Broadcaster Sees It	- - - Carl Dreher	568
	Drawings by F. F. Stratford	
Standards for the Home Laboratory	- Keith Henney	573
The Listeners' Point of View	- - John Wallace	577
An All-Purpose Coil Winder	- Edward Thatcher	582
The First Report on the International Tests	Willis K. Wing	588
Super-Heterodyne Construction	- Harold C. Weber	589
The Grid—Questions and Answers	- - - - -	594
Variable Voltage from a "B" Substitute		
A Loop R. F. Receiver		
Making Grid Leaks		
Operating Characteristics of the New Tubes		
Charging Storage Batteries from D. C.		
"Now, I Have Found"	- - - - -	600
How to Make Balloon Coils		
An Audio Bypass Method		
Improved Loud Speaker Reproduction		
A Low Loss Coil		
One Use for a Bypass Condenser		
A New Way to Make Money in Radio	D. C. Wilkerson	606
A Key to Recent Radio Articles	E. G. Shalkhauser	608
What Our Readers Write	- - - - -	618

## BEHIND EDITORIAL SCENES

THE present number of RADIO BROADCAST was prepared and edited during the week of the International Radio Broadcast Tests, but in spite of the disorganization of office personnel and the conventional magazine routine, we feel that a very interesting lot of radio material has been assembled. E. E. Horine, who wrote, "A Man and His Hobby" which is the leading article, is known to many radio men as assistant radio manager of the National Carbon Company. Professor Morecroft, in his comments about the Naval Radio Service, has stirred up considerable discussion, with rather vocal partisans on each side. In attempting to take a neutral position, we have been accused of attempting to accomplish all sorts of dire ends. But as Professor Morecroft has stated, the only purpose has been to indicate what seemed to us to be the facts and to try to discover how conditions may be remedied.

RADIO'S relation to weather conditions has been discussed ever since the coherer days of the art, but we doubt if any more important or complete information has been presented than Mr. Jensen gives in his article, "Can We Forecast Radio Reception from the Weather?" By carefully studying the maps and curves in the article, experimentally inclined radio folk have opened to them a most interesting field for investigation. And Mr. Landon's article on multiple regeneration is also a frankly experimental presentation of a subject which has very large possibilities and we expect many interesting reports from home constructors who put some of Mr. Landon's suggestions to practical tests. The long-awaited third article in the series for the home constructor who wants to go further in radio than set building appears on page 573, and if the letters addressed to Mr. Henney, the author of the series and director of our Laboratory are any indication, those to follow are also eagerly awaited. That interest is not hard to explain, for the series is packed full of material of the utmost help to the radio-ambitious.

FROM our correspondence from the increasing number of experimenters interested in short wave transmitting and receiving, it would appear that RADIO BROADCAST's \$500 prize contest for the design of an efficient short wave receiver was attracting a great deal of interest. Our amateur contemporary, QST, devoted a page to announcing the contest in its February issue. For those who have not seen particulars of the contest, full information may be had by writing to the Director of the Laboratory, RADIO BROADCAST, or on page 444 of this magazine for February.

IN THE April RADIO BROADCAST, we can promise another one of Keith Henney's absorbing and informative articles on tubes. There will also be a distinctly helpful article on various means of filament control, prepared by John B. Brennan, Technical Editor of this magazine. There will be a review of the International Radio Broadcast Tests which will be of interest to nearly every radio listener who has a receiver more elaborate than a crystal set.—W. K. W.

### Doubleday, Page & Co. MAGAZINES

COUNTRY LIFE  
WORLD'S WORK  
GARDEN & HOME BUILDER  
RADIO BROADCAST  
SHORT STORIES  
EDUCATIONAL REVIEW  
LE PETIT JOURNAL  
EL ECO  
THE FRONTIER  
WEST

### Doubleday, Page & Co. BOOK SHOPS

NEW YORK: { LORD & TAYLOR BOOK SHOP  
PENNSYLVANIA TERMINAL (2 Shops)  
38 WALL ST. AND 166 WEST 32ND ST.  
GRAND CENTRAL TERMINAL  
ST. LOUIS: { 223 NORTH 8TH STREET  
4914 MARYLAND AVENUE  
KANSAS CITY: { 920 GRANO AVENUE  
306 WEST 47TH STREET  
CLEVELAND: HIGBEE CO.  
SPRINGFIELD, MASS.: MEEKINS, PACKARD & WHEAT

### Doubleday, Page & Co. OFFICES

GARDEN CITY, N. Y.  
NEW YORK: 285 MADISON AVENUE  
BOSTON: TREMONT BUILDING  
CHICAGO: PEOPLES GAS BUILDING  
SANTA BARBARA, CAL.  
LONDON: WM. HEINEMANN LTD.  
TORONTO: OXFORD UNIVERSITY PRESS

### Doubleday, Page & Co. OFFICERS

F. N. DOUBLEDAY, *President*  
A. W. PAGE, *Vice-President*  
NELSON DOUBLEDAY, *Vice-President*  
RUSSELL DOUBLEDAY, *Secretary*  
S. A. EVERITT, *Treasurer*  
JOHN J. HESSIAN, *Asst. Treasurer*

DOUBLEDAY, PAGE & COMPANY, Garden City, New York

Copyright, 1926, in the United States, Newfoundland, Great Britain, Canada, and other countries by Doubleday, Page & Company. All rights reserved.  
TERMS: \$4.00 a year; single copies 35 cents.

# RADIO 'RITHMETIC



## Multiply distance by adding a *RECTIGON*

**A** SIMPLE solution for so big a result! Want band music? Try KDKA. Jazz? Theatricals? Maybe you'll find it at WBZ, KYW or KFKX. What your local stations won't provide can be obtained easily from somewhere else.

How well you receive radio entertainment depends upon the condition of your batteries —and that's up to you. With a Westinghouse

Rectigon on the job both your "A" and "B" batteries can be kept fully alive to the greatest possibilities of your set.

And it's easy as can be. Just snap on the leads and turn on the current. There's no muss or fuss; no acids; no chemicals, and no noise. The Rectigon more than pays for itself within a short time.

WESTINGHOUSE ELECTRIC & MANUFACTURING COMPANY

SOUTH BEND, INDIANA

# The Westinghouse Rectigon Battery Charger



No storage-battery radio is complete without a **RECTIGON.**



© 1926, W. E. & M. Co.

Westinghouse manufactures, also, a complete line of Micarta radio panels, Micarta tubes and instruments.

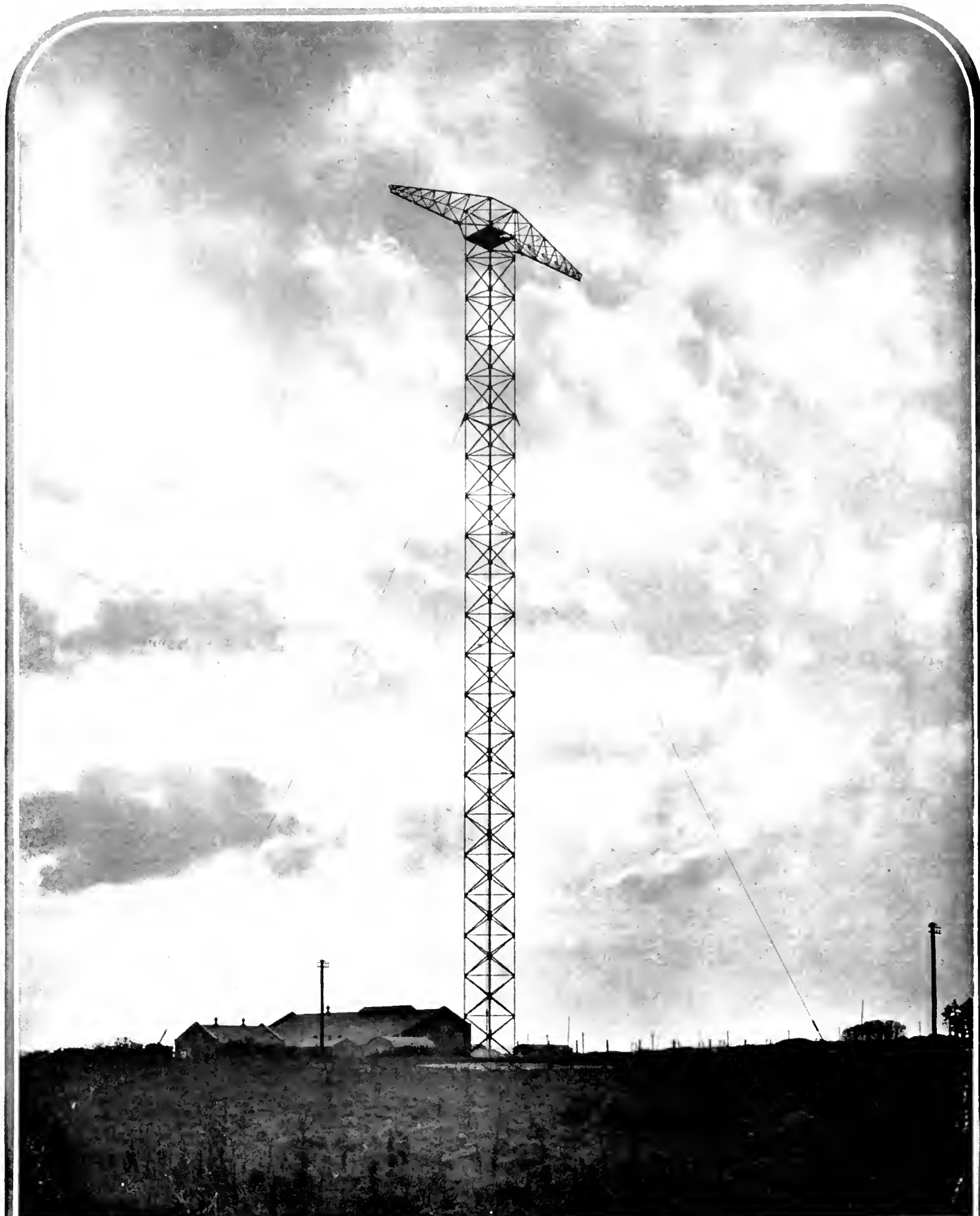

#### WHERE ENGLISH MESSAGES LEAVE FOR THE UNITED STATES

One of the majestic towers of one of the new beam stations of the British Marconi Company. The station is located in Dorchester, Dorsetshire and was chiefly erected to communicate with stations on the east coast of the United States. Tests with the new equipment have been progressing for some time

# RADIO BROADCAST

VOLUME VIII



NUMBER 5

MARCH, 1926

## A Man and His Hobby

*The Story of One Man's Experiences With Short Wave Code Transmitters on Low Power—The Philosophy of the Radio Amateur—How Australia Was Reached From British Columbia With Batteries and a Receiving Tube as a Transmitter*

By E. E. HORINE

**A** NEW and thrilling experience is in store for the dyed-in-the-wool broadcast listener when he first tunes-in on the shorter wavelengths set aside for the use of the amateur. Around about 7500 kc. (40 meters), the air is literally full of signals of all kinds, day and night, summer and winter. It's all code down there. No grand opera stars singing in heavenly voices; no prominent speakers wagging the silver tongue; no jazz. Only a succession of queer sounding dots and dashes, in all manner of tones and pitches, from low guttural growls to high-pitched, clear, chirping notes. Some of them sound as if they might have originated next door, while others create the impression of having come across thousands of miles of ocean and land; and the chances are they have, for it is an everyday occurrence for amateurs of different nations, on opposite sides of the world, to converse with each other. The field of amateur radio is the dx fan's paradise, and therein lies a part of the fascination of the game.

Listening-in on the amateur bands stirs the imagination and arouses the curiosity. There seem to be thousands of these amateurs at work, bombarding the ether with their messages, clamoring away, trying to engage some one's attention perhaps thousands of miles distant. Who are these amateurs? What kind of

folk are they? What do they talk about? What keeps them so everlastingly at it?

The best way to answer these perfectly natural questions is to recount the story of what one amateur has done. Clair Foster, or to give him his correct entitlements, Colonel Clair Foster, 6 HM, Carmel, California, is more or less a newcomer to the ranks of amateur radio. He calls himself a greenhorn, but there are those who will take emphatic issue with him on this score. Two years ago, he knew nothing about amateur radio. He had constructed a few broadcast receivers and was beginning to yearn for new worlds to

conquer, when he met John Reinartz. And that meeting was the beginning of a new life for Colonel Foster.

His first and natural objection was he couldn't read code, but this was pooh-poohed, laughed at, ridiculed. Anybody can learn the code; a little study, a little practice, and you are ready to stand the examination for a transmitting license. Age is no barrier, nor is sex, for there are many girl amateurs, YL's in "ham" language.

Foster says the small time and study he devoted to learning the code was the best investment he ever made. It has been the means of opening up for him a new field of activity; it has brought him a host of new friends, many of them on the other side of the world, with whom he is on terms of closest intimacy, yet whom he has never seen, and probably never will see. It has drawn him into an international fraternity guided by a self-imposed code of ethics that comes closer to being a literal application of the golden rule than anything else on this earth. It has afforded him the most pleasant hours of his life, and turned him into a youth again, bubbling over with enthusiasm.

HATS OFF TO THE FIVE  
WATERS

**H**IS station at Carmel, California, 6 HM, uses a 250-watt tube, and with it he has "worked" fellow amateurs in the Philippines, Japan, Australia, and other



LOOKING TOWARD AUSTRALIA

From the little shack of Col. Clair Foster's radio cabin near Port Alberni, B. C. The mountain is called Mount Arrowsmith, and did not seem to block the modest radio signals from the battery-operated, 5-watt, short wave transmitter installed here by Colonel Foster and operated under the call C9CK. The story tells how a simple transmitter was built and communication established all the way across the Pacific with amateur radio men in Australia

countries. But he feels that reaching out to great distances with high power isn't so remarkable. It's the fellow who does it with low power that deserves credit for real achievement, and this "most miles per gallon" idea is now coming in for a great deal of attention on the part of the amateur. Commenting on this phase of radio transmission, Foster says,

After working a number of distant stations that were using very low power, my hat came off to the chaps who could put out such clear and steady signals with 5 watters—and even 201-A receiving tubes. Every one I bumped into I boned for his dope, and I have collected through their courtesy quite a bunch of it. I see no especial credit coming to the fellow who busts out with the big tubes. Of course it is satisfying to have a wallop so that when you answer a CQ (general call) you are the fellow the other chap almost surely hears; but the big field for the practical use of radio can't be opened up with the use of big, expensive equipment. Only a small proportion of those who will become interested in transmission can afford the heavy outlay.

The big tubes themselves are expensive, and they require a rather costly array of auxiliary apparatus for their operation—a high voltage motor generator, or a system of rectifiers and filters to convert the commercial alternating current into as close an approximation of the pure direct current of batteries as possible. But with the small tubes, the installation cost of a complete transmitter becomes ridiculously low. The transmitter itself can be built for much less than the cost of a good broadcast



THE TRANSMITTER THAT TALKED TO SOUTH AUSTRALIA

The photograph was taken before the coils were changed. The most notable feature of the outfit is the careful placement of the parts which certainly had much to do with the extraordinary results produced by the arrangement

receiver, and it can be operated successfully and reliably from B batteries.

Foster's low power transmitter, 9 CK, was designed and built in California, but was operated all summer at a point on Vancouver Island, about 125 miles north of Victoria. The outstanding characteristic of this transmitter is the careful and painstaking workmanship expended on its

construction. There is nothing ragged or loose about it. Every part fits perfectly in its appointed position, and the coils, as can be seen, are made of heavy copper strips, with nothing touching the turns. They are supported by their own rigidity, and the whole transmitter is just about as low loss as it is possible to build such a set. This careful attention to small details is largely responsible for the fine work done by this transmitter.

The shack was located on the shore of a lake surrounded by snow capped mountains over which or through which the signals from the little transmitter had to pass to get anywhere. It is a wild, rugged country, remote from civilization, and naturally no electric power available for any purpose. There is only one way to get power in that country, and that is to carry it along in the form of batteries.

But that wasn't the real, fundamental reason for deciding to run his low power transmitter with B batteries. If the weak signals put out by such apparatus are to get anywhere, it is essential for the note emitted to have a high, penetrating sound, otherwise it can't be read at considerable distances, and batteries are ideally suited to impart to the transmitter a tone that is not only penetrating, but steady and free from swinging.

In connection with the use of B batteries for power supply for transmitters, Colonel Foster said, in one of his earlier letters written before leaving Carmel for Vancouver Island,

Along this line, most of us on 15,000 kc. (20 meters) have been using 250-watt tubes. But 9 DFH has the steadiest signals I hear, and he is using a lonely 5-watter (about the size of an ordinary receiving tube) with less than 20 watts input. And recently, I worked 4 BL, in Lakeland, Florida, who was coming in here fine through heavy static disturbance, using a 201-A



THE COMPLETE OUTFIT AT C9CK

The transmitter, receiver, "power plant," and operator—Colonel Clair Foster himself. Note the wavemeter on the right top of the table





with an Australian station from Vancouver Island, using a 201-A receiving tube, is a notable achievement, but not a record. Other amateurs have surpassed this performance, and while naturally elated at his success, Colonel Foster was conscious that there was danger of his lapsing into the role of the joyous ham experiencing a major thrill instead of maintaining the attitude of a cold-blooded observer; for after all this might prove to be freak transmission. To settle this point, he and 5 BG arranged a daily schedule, the idea being, that if they could repeat the performance day after day, it would establish beyond any doubt that there was nothing freakish about it. The maintaining of that schedule is one of the outstanding points of amateur radio history, for they kept it up for fourteen days without a break, through all kinds of interference from other stations and static, under conditions not considered favorable for transmission and reception. And the daily schedule was finally discontinued, not because communication became impossible, but because they had demonstrated conclusively that reliable two-way communication could be established and maintained with extremely small power.

#### THE AMATEUR: CURIOUS MIXTURE

**A**MATEUR call letters consist of a numeral followed by two or more letters. This was all very well for a while, but of late, international communication has become such an everyday occurrence, that it has become necessary to adopt some means of separating the nations of the earth! It is customary to precede the regular call letters with an initial, designating the country in which the station is located. For example: U 6 HM is station 6 HM in the United States. C 9 CK is in Canada; A stands for Australia, Z for New Zealand, etc. This old earth of ours is rapidly getting too small to hold the amateur!

The fourteen day schedule with Kauper reveals the many-sided nature of the ham. He is interested in his work, and takes it seriously, but not too seriously. He is human, just like the rest of us, and enjoys a joke as well as anybody. In fact, the amateurs have coined a word which is used to indicate the appreciation of a joke, or to call attention to what is considered a joke. Like most of the words in ham language, it is short, for it must be remembered that all communications are spelled out, letter by letter, and short words are at a premium. This particular word is "Hi."

Freely translated, it means, "That's a hot one! Consider me laughing. Ha! Ha!" Or, in case the sender interjects a "Hi" into a sentence, it means, "That's a joke—you are supposed to laugh now."

They have a lot of fun, these hams, in the pursuit of their labors. There is no formality about them. Everybody is OM—old man. Log sheets of amateur stations fairly bristle with OM's and other abbreviations which are as useful and effective as they are curious. Here is the way it goes. This is A 2 TM talking to C 9 CK at 6:15 A.M. August 13.

Only last part OM—missed QRA (your location) again OM—say OM, send V's after call till I get you best then QRA please—think about record for low power OM—congratulations OM, very fine business—want get your QRA OM please try again.

Six "old mans" in one short message! That's ham language.

The intimate side of the relations between amateurs is revealed in this message from Foster, commenting on his intercourse with Kauper, A 5 BG.

Our times are, of course, widely apart. Kauper takes in an evening movie show, then goes to his "shack" as every ham fondly terms his little sanctum, the privacy of which must never be invaded by the uninitiated without special invitation—to listen for C 9 CK. Day before yesterday he asked "Just what is your time now," and added "Ours is 11:25 P.M., August 27th". I replied, "5:55 A.M., August 28th." Next time he came back he said "Thanks for time. Hi."

Such conversations flashed back and forth across the vast expanse of the Pacific bring out many intimate touches like that. The daily habit of going to the movies; the fact that Kauper is married and that his wife sometimes objects to his sitting at the key so late at night; and many others. And all this with a man more than nine thousand miles away, but who, thanks to radio, is also your next door neighbor. That's the kind of associations formed by amateurs. No wonder the ranks are filling up with newcomers.

One of the first things Colonel Foster told Kauper was that his little transmitter was being run by B batteries, such as are used for reception, because that was one of the unusual features of the installation. Kauper appreciated the significance of the use of batteries, and made frequent comments on it. Several times, when the going got too hard for him he said "Can read, but can't you stick a few more B batteries on her?" One day, when the signals arriving in South Australia were exceptionally loud and clear, Kauper said "Say OM, you must own a couple of B battery companies, Hi."

This kind of thing kept up for two solid weeks. The original plan was to keep the schedule for only one week, but the going was so good that they hung on for another week. Colonel Foster is convinced they could have kept it up indefinitely. Even after the schedule was completed, he and Kauper chatted back and forth every now and then, apparently enjoying the freedom from their self-imposed task.

#### TRANSMITTER COST VERY LOW

**I**T IS hard to realize that this vast distance was bridged with a little transmitter that any one with a little knowledge of the subject can build at a total outlay of not to exceed \$50.00. That's the wonderful part of it. This low power, long distance transmitting is not a rich man's game—it is within the practical reach of all. And in the amateur ranks, there is room for all. They welcome the new comer with open arms, and go to unbelievable lengths to help him get started right.

Colonel Foster, like all hams, has his facetious moments. Commenting on the performance of the 201-A tube in his transmitter, he said:

In all fairness I should make the confession that this particular 201-A tube is not an ordinary 201-A. It was especially prepared for this job. It spent eighteen months as an oscillator in a broadcast super; then it worked for a while as a detector in a receiver built solely for very short waves. In this way it gained a lot of

experience as an oscillator so of course it knew its business when it entered the transmitting field.

Colonel Foster is thoroughly convinced of the value of using B batteries with low power transmitters. In his enthusiasm over this form of power supply, he is doing all he can to get other amateurs to duplicate his apparatus, batteries and all, for he is convinced that with any other kind of power supply he

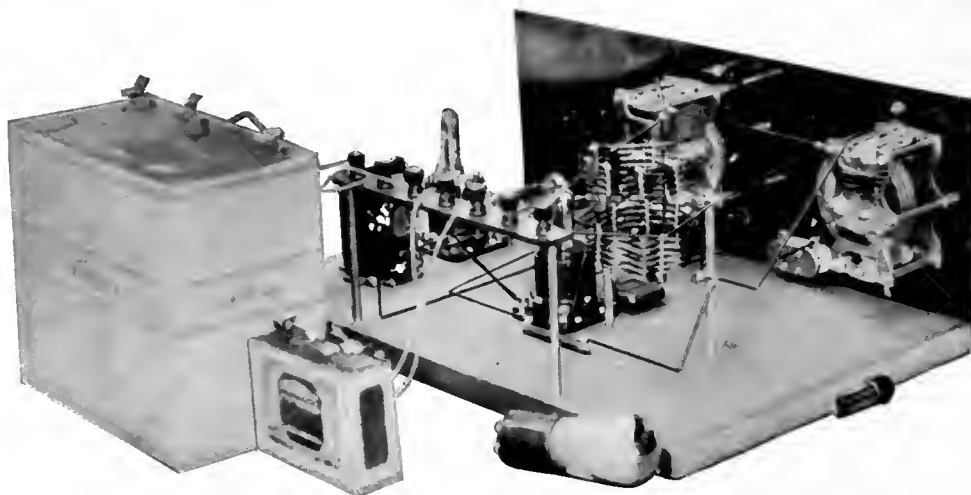

THE SHORT WAVE RECEIVER

Which is not much larger than a B battery. A receiving 201A tube, used as a transmitter is on the table, near a "peanut" tube used in the receiver

would never have made the fine record of keeping a two weeks daily schedule with Kauper, away down yonder on the under side of the world.

Writing about his plans for the winter at Carmel, he said:

"I'm going to keep on using dry cell B batteries for this work even if I have to give up a hundred dollars apiece for them"

That was written after five months grilling had only partially exhausted the B batteries he took with him to Vancouver. They are now reposing in a warehouse in Port Alberni, waiting for next summer's work.

He takes none of the credit of his accomplishment to himself but distributes it impartially between the batteries and the amateurs who helped him out—typical of the generous spirit of hamdom. His letters are full of praise for Kauper and the way he hung on through the schedule. He goes on to say of his Australian friend:

"Am simply lost in admiration of that chap. Just think of the courage displayed in asking for a report that of necessity must be more or less complicated, and knowing that it must come back to him in a thin, high, bird-like note that must take a mighty fine pair of ears to hear at that distance. Only one thing in his favor—C9 CK's note is *absolutely* steady. It has been so reported all over the map. This is due partly to the set and the way it is adjusted, but more to the fact that both filament and plate supply are from batteries."

And again:

Kauper is a wonderful chap. It is obvious that he is keenly alive to the fact that in keeping this daily schedule under actual working conditions Australian amateur station 5BG and Canadian amateur station 9CK are helping to make radio history.

Once, after recounting in detail all the messages flashed back and forth across the Pacific in one of their scheduled communications, Colonel Foster burst out with:

"There's a game boy for you! That's the kind of stuff that has sent the amateurs ahead so fast in this new and marvelous short-wave field that the commercial interests, professionals, and high-brows can only plod along behind in the dust and pick up what the amateurs let drop."

And that's a typical amateur attitude too. But pardonable.

Enthusiastic as he is over past amateur performances, Colonel Foster is even more enthusiastic over the future possibilities. And the more amateurs there are testing



BREAKING CAMP AT 9CK

As Harry Lyman started away from the radio shack, he remarked, "Well, here goes C9CK's famous QSB", Which meant C9CK's high, penetrating, flute-like note

away and experimenting with new things, the sooner his dream will come true. It isn't an expensive game—quite the reverse, especially in the short-wave, low power field. And in the opinion of many, that is the field where the greatest radio progress is to be made in the next few years. The ease with which one can embark on this fascinating, thrilling enterprise of radio transmission will doubtless be responsible for hosts of new recruits into the amateur fraternity.

Colonel Foster's comments on the future

of amateur radio are timely and pertinent.

"I feel that in these experiences of mine there is really a big story. You know me well enough to know that I don't mean big because I did it. It is big because the infant art of radio did it, and is continuing to do it. It is big because of the far-reaching possibilities it discloses for the human good. Not theorizing as to the probability of long distance communication with extremely low power, but proving the practicability of it by doing it day after day. Unlike the automobile, heralded as the greatest promoter of human progress, radio can never be used to the great advancement of the bank robber, gunman, and bootlegger.

And just look at the future possibilities, certainties of this inexpensive low power stuff as a promotor of peace among the peoples of the earth. Why, with all the warm friendships that are being born every day among the radio amateurs of one country with those of another, it will soon be all a politician's life is worth to say, "Let's start something." Just fancy some big stuffed shirt's telling me to go out and fight young Kauper!

And that, mind you, was written by a reserve officer.

Since the completion of the summer's adventure on Vancouver Island and the termination of correspondence regarding it, Colonel Foster has paid us a visit here in the East. He is as sunny, as breezy, as enthusiastic in person as one would imagine him to be from his letters. A most pleasant, human and companionable man.

He has retired from active participation in all business and is pursuing the radio transmission game as a hobby. Unlike many hobbies, his is useful, not only to himself, but to others. And he is not a one-sided man, as are many hobby riders. He can discourse entertainingly on any subject proposed, for he has led an active life, full of many and varied experiences. He has a wealth of good stories, and he tells them with a merry twinkle in his eye that belies his years.

He has worked hard, borne heavy responsibilities, achieved much; and now, after a useful and successful business career he is really enjoying life—thanks to radio. Colonel Foster represents just one type of man to whom amateur radio has appealed and lifted to a higher plane of enjoyment of life, and what it has done for him, it will do for any one, young or old, who seriously takes up this new and fascinating game.

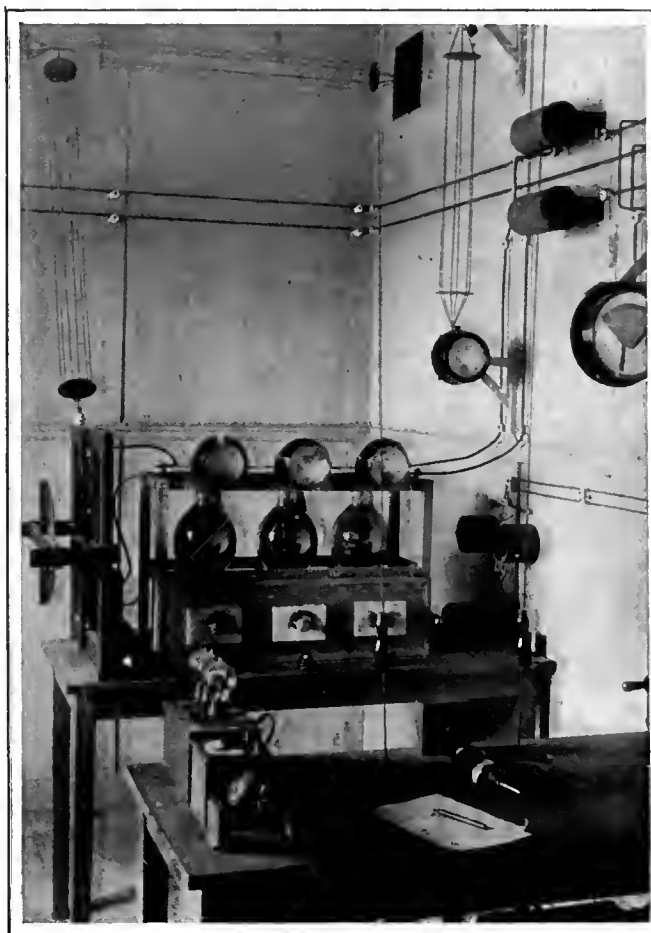

A 500-WATT AMATEUR STATION

Owned by *La T. S. F. Moderne*, a French radio magazine. This might almost be dubbed a superpower station when compared to the "midget" transmitter used so successfully by Colonel Foster

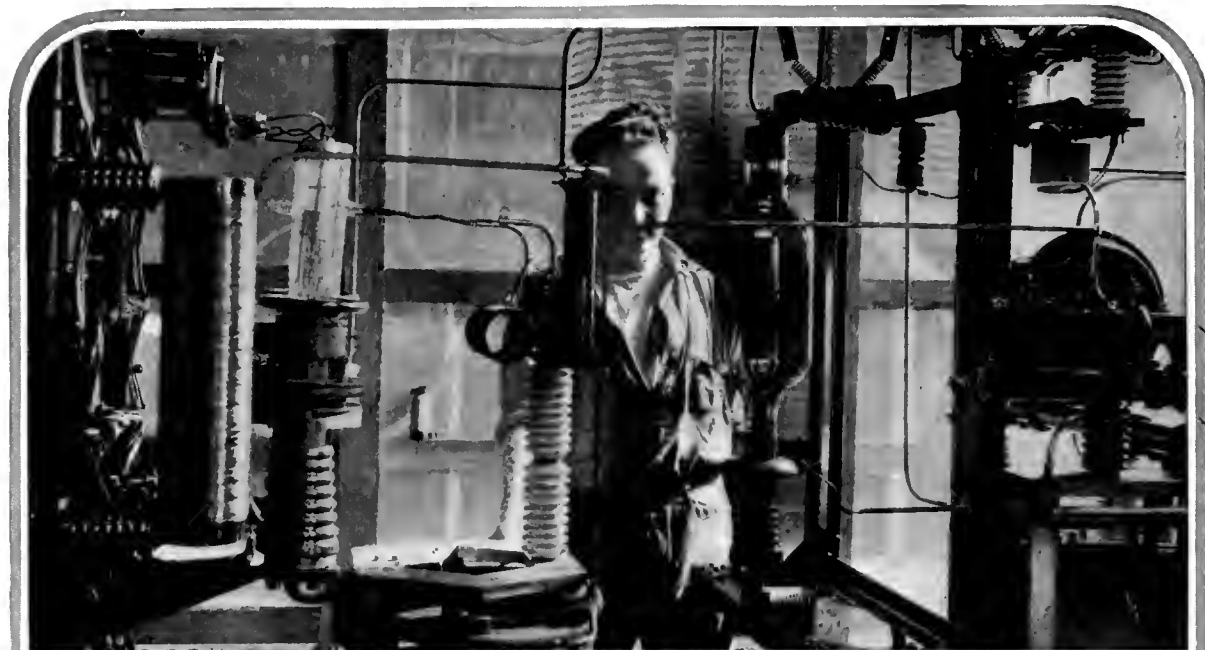

# THE MARCH OF RADIO

By *J. J. Morecroft*

Past President, Institute of Radio Engineers

## Additional Opinions About the Naval Radio Service

OUR comments regarding the Naval Radio Service in the December RADIO BROADCAST brought forth some letters from our readers which deserve presentation with at least as much emphasis as that used in giving our own ideas. Elsewhere in this issue there is printed a communication from Mr. H. A. Halcomb, who was in the radio service at the time when our destroyer squadron went aground on the California coast. He enjoys the distinction of "knowing" that radio was not at fault in this accident, as his log was used in the investigation. Evidently then Mr. Halcomb knows that the radio bearings received by the fleet were correct—and still the fleet ran aground! Does this mean that the radio bearings were considered of so little importance by the navigating officer that he preferred to cruise by dead reckoning? Had the radio compass service proved of so little reliability in the past that a navigator at that time preferred to depend upon his judgment of the effects of currents, winds, etc., rather than plot his position on a chart in accordance with the radio signal? If so (and we can see no other way to recon-

cile the event with Mr. Halcomb's statements), hadn't radio failed to function properly, to lead up to such a catastrophe? The spirit in which our comments were made was a friendly one, and not one of cynical criticism. We were attempting to answer the question—is radio doing as much for our Navy as it is capable? If not, conditions should be changed either by increasing the reliability and utility of the radio service or in educating the personnel properly to appreciate its worth.

Another letter taking us to task for the article comes from Mr. C. J. Pannill, vice-president of the Independent Wireless Telegraph Company. Mr. Pannill says:

An article of this kind may do the Naval Communication Service considerable harm, and it is only fair to ask that Professor Morecroft get in touch with the proper authorities in the Navy Department and set the public right through the publication in RADIO BROADCAST of a correction to his article mentioned. My idea in taking this matter up with you is due to my particular interest in the Naval Communication Service, since I had a good deal to do with laying the foundations of the service during the time I served in the Navy.

Now it is just possible that pointing out the way in which radio has not proved it-

self may do the Naval Communication Service more good than could be accomplished by the method suggested by Mr. Pannill. If misstatements were made, we shall be the first to apologize and retract them, but in spite of some of Mr. Pannill's remarks, it is not evident that our criticisms were in error. The circumstance which brought forth our comments was the dismal failure of radio communication in the *PN-9 No. 1* near-disaster. Referring to the U. S. S. *Honda* affair and the *PN-9 No. 1* failures, Mr. Pannill says that "they are not chargeable to any one branch of the Navy or its organization. These failures may have been the fault of the Navy but the reasons assigned were not sound and were evidently written without adequate knowledge of the facts."

It so happens that as Mr. Pannill's letter came to hand, we were reading further evidence on the *PN-9 No. 1* inquiry and found that "Lt. Byron J. Connell, pilot of the *PN-9 No. 1* said that he was satisfied the *PN-9 No. 1* failed to locate the *Aroostook*, the last of the station boats on the Hawaiian flight, because the radio bearings received were in error. The plane followed the bearings given and landed in the sea to remain there for nine days." In the same hearing, Commander Rodgers said that the

The photograph in the heading above shows one view of the 20-kw. vacuum tube transmitter at the Naval station, NAA, at Arlington Virginia. Note the water-cooled tube. © Harris & Ewing

failure to reach the *Aroostook* was "due to confusion of radio bearings and possibly an error in navigation."

In contradistinction to the two letters mentioned above, attempting to "soft pedal" radio's performance in the two instances named, the Navy itself sent us a most courteous inquiry for suggestions as to what constructive criticism we could offer.

As Mr. Halcomb says, it is easy to sit back and criticize what others have done but how to do better? Well, in the interest of radio progress, we insist again that the *PN-9 No. 1* should have had an emergency radio outfit. Too much weight? Then leave one of the men at home and make the rest of the crew work a little harder. Better have eight overworked men arrive at their destination than nine men somewhat less fatigued drifting helplessly toward Japan.

Unless one has looked at a map of the Pacific in the vicinity of this near-disaster he cannot realize how closely this crew came to perishing. It is almost an accident that they happened to drift into an island. Had the direction of wind changed a little they would probably have drifted clear into the Pacific—forever.

Shouldn't there have been some radio outfit aboard which would keep them in touch with their supply ship when they were forced down? It is doubtful if any sensible man to-day would differ with us.

If such a flight as that to Hawaii is so close to the impossible that even the added weight of an emergency radio outfit would spell failure then it should not be attempted. The Navy is not supplied with so many capable airmen that it can afford to take again chances as it took in that flight. Those responsible for such projects as was attempted by the *PN-9 No. 1* will never be told by their junior officers that the chances of success are too slim to make the scheme worth while—our officers are not of that mind. It remains, therefore, for some rank outsider, such as ourselves, to venture the statement that possibly things should have been done differently.

### The Progress of Radio in 1925

PROBABLY the one event standing out more than any other during the year 1925 in so far as the interests of the general listener are concerned, was the spirit in which the questions arising at the National Radio Conference were settled. While the conference could not give Secretary Hoover any power to act, it brought to him so strongly the sentiment of the country on certain of radio's problems that he has been able to act since then with the assurance that the radio public was behind him. It is notable that for some weeks now, not a single broadcast license has been issued. It is hoped that this condition will continue.

All questions arising in the broadcasting realm, said the radio conferees, must be settled in the interests of the broadcast listeners and the establishment of this

policy for the guidance of future radio executives will prove to be a real boon to all of us. Any sensitive set to-day gives heterodyne notes in many of the radio channels which are supposed to be without interference and this situation can be remedied only by keeping constantly in mind the policy that the interest of the listener, rather than that of the broadcaster, must prevail. Many of our present stations must soon be eliminated, and this event was certainly predicted by the spirit of the radio conference.

The great attempt being made to furnish the public with a satisfactory battery eliminator is perhaps the next outstanding feature of the radio season just passed. Not yet successful enough to call the problem solved, yet near enough to make us believe that the real solution is at hand, the work of those radio engineers engaged on this problem is probably of more present significance to the broadcast listeners than any other. Of course, as the battery interests maintain, there are many places where 110 volts a. c. cannot furnish power for the radio outfit because there are many houses which do not have it. The number of such homes is rapidly diminishing so that it may truthfully be said that the battery eliminator (for both A and B supplies) is awaited to-day by millions of listeners.

The remarkable popularity of the straight line frequency condenser shows that there was a real demand for such a piece of apparatus. First introduced about two years ago, it has, during the past year, shown itself so valuable that the old semi-circular plate condenser has today a limited sale. The innovation of this specially formed con-

denser, spreading out the stations on the lower part of the dial, was a decided help to the broadcast listeners.

The use of the piezo-electric crystal as a frequency stabilizer will soon be looked back upon as one of the milestones in the improvement of radio transmission. With the present spacing of stations on the frequency scale, some standardization scheme is absolutely necessary and the curiously acting bits of quartz crystal which serve to make a small tube oscillate at an exact and constant frequency, are accomplishing this purpose admirably. Rochelle salt is about one hundred times as active a crystal as is quartz and would probably serve the purpose even better if it were not so fragile, and soluble in water. Piezo-electrically a wonderful material, it is mechanically so inferior to the durable and constant quartz, that the latter will undoubtedly soon be fixing the frequency of all our important broadcasting stations.

Picture transmission by radio secured a large amount of attention during the past year, but so far has become commercially important over only one or two channels. It is sure to develop into a service of immense importance (with the possibility of doing away altogether with our dash and dot communication system) but much development work remains to be done before that is accomplished.

The quality of reception in the average receiving set was much improved during the past year. Great improvements were made in the characteristics of tubes to operate with loud speakers, by the research engineers of the General Electric Company, and several fundamental and important



A CORNER IN THE RADIO CABIN OF A NEW ITALIAN LINER

The *Conte Biancamano*, which is said to be the largest liner flying the Italian flag. The installation is quite modern. A 500-watt tube transmitter for telegraphy can be seen in the right hand corner. Note the position of the transmitting key, just a few inches from the edge of the operating table. This position would be almost an impossible one for an American operator, as practically all of the operators trained here use a sending motion which rests the entire arm on the table

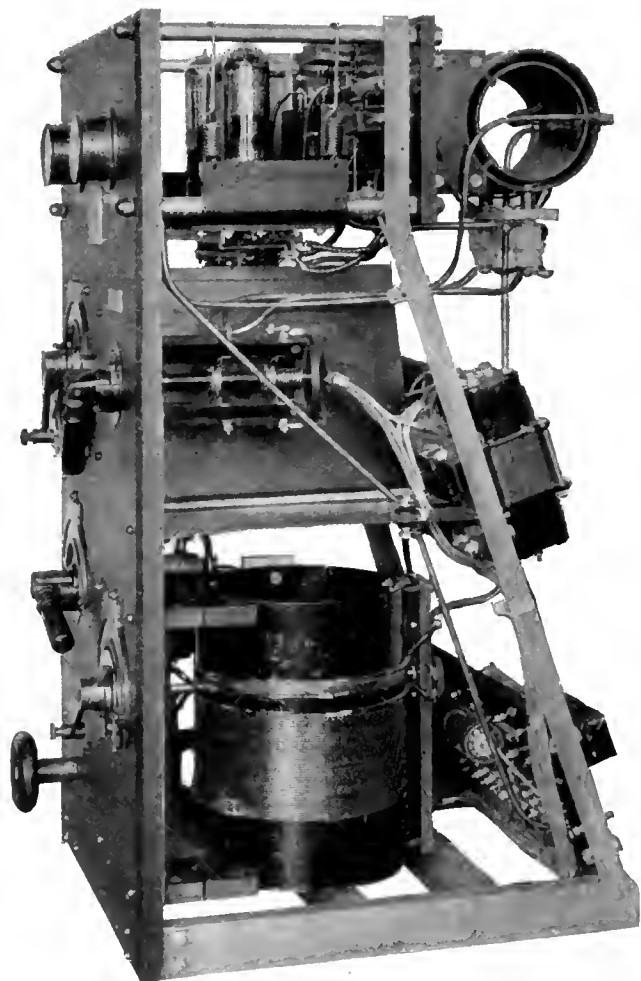

ONE OF THE RADIO DEVELOPMENTS OF 1925

A beautifully compact vacuum tube commercial transmitter with a power of two hundred watts. This outfit has a wavelength range of 600 to 900 meters and is especially designed for radio telegraphy aboard ships

studies of the characteristics of loud speakers themselves were reported to our engineering societies. To some extent keeping pace with the improved quality of reception of the average receiving set, the programs themselves may in general be considered as somewhat better than last year. Most notable among the year's accomplishments in this direction is the series of Atwater-Kent Musical Hours. Not less pleasing, even if less important, are several series of concerts by certain of our well-known trios and ensembles. The "Dinner-Hour" music is a real treat for the average suburbanite, who gets the benefit of good music with his meals without the disadvantage of a cover charge. As one turns from station to station, however, at about eleven o'clock in the evening, he is impressed with the concentration of jazz. It is hard to believe that there really is a demand for the concoctions the average dance orchestra sends out over the midnight radio channels.

With the advent of two 50-kilowatt stations, WGY and WJZ, the era of international broadcasting seems ready to start. The re-broadcasts which have occurred to date, of programs flung across the Atlantic, haven't been worth while except as a "stunt." But by raising the signal strength ten times or more, the static disturbance

may become comparatively unimportant. In general, these high powers have not caused as much disturbance as had been anticipated; those close by (within a few miles) have no doubt been well deluged with the energy of these powerful stations, but by using proper traps to bypass most of their signals, much of the present trouble will disappear. A proper policy for a super-power station to adopt would be to start operation on very low power and gradually to increase the radiation, taking perhaps three months to grow to their normal rated strength. This method of procedure would do away with much of the complaint as the near-by listeners would gradually become accustomed to methods and apparatus for eliminating these powerful signals.

The feeling against the regenerative receiver has steadily grown until the listener is almost ashamed today to acknowledge the ownership of such a set. The man known to operate such a receiver is at once blamed by his neighbors for all the howls they hear and the continued cultivation of this attitude, by those owning non-radiating receivers, will do much to hasten the demise of this undesired member of the receiver family.

A most remarkable study of wave interference and signal distortion was reported during the past winter and it seemed to the writer that Bown, Martin, and Potter, the research engineers responsible for this work, were laying out for themselves a unique problem on which they will probably work alone. It is likely that these engineers will do this work so well that the field becomes theirs and we shall look entirely to them for explanations of transmission phenomena.

In the patent situation, the granting of the high vacuum invention to Langmuir stands out as the one event of the year. Continued and expensive litigation along other lines points out the entire inadequacy of our present patent scheme. It seems nowadays that the granting of a patent has scarcely more significance than a license to sue others. The overworked staff of our Patent Office is so loaded up that frequently five years or more are required for a patent to be issued. Secretary Hoover may be able to arrange some new method of procedure so that much of the wrangling, which now takes place before a court after the patent is issued, might be heard before the patent is granted, so that the patent is really of some value to the inventor; at present it is worth practically nothing unless he is backed by some powerful corporation.

The year has seen a growing appreciation of the value of scientific research—not the research having as its goal a new receiving set, or more economical triode, but research in the realm of pure science, the kind undertaken to determine the truths of an unsolved problem. Not only has the work of the pure scientist received increasing recognition, but from the highest sources, words of appreciation have been showered upon him.

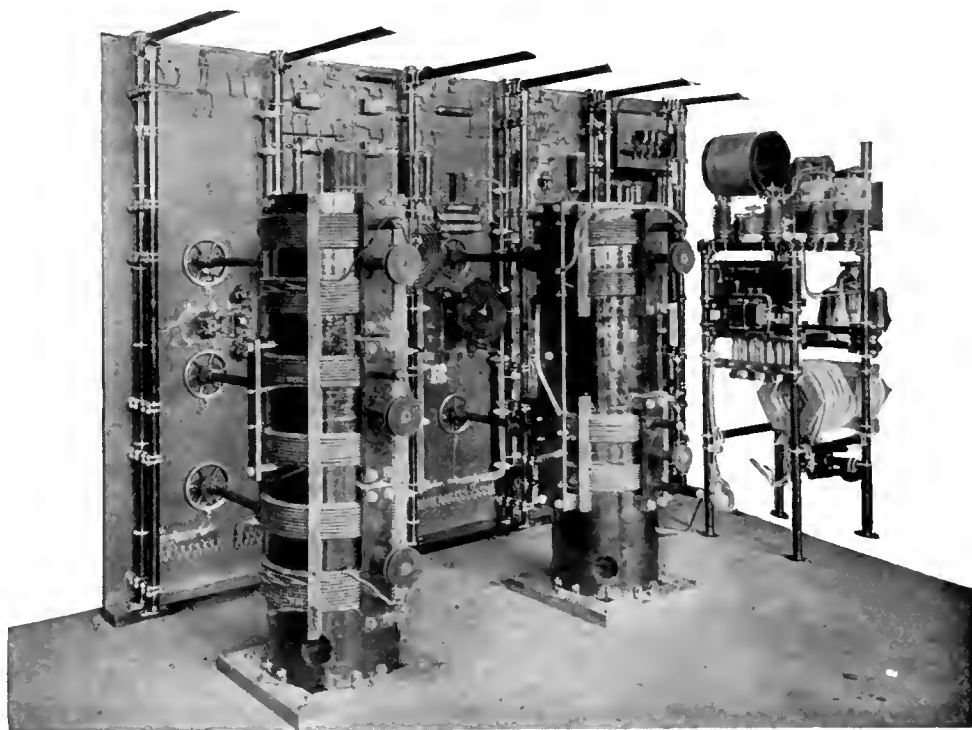

THE CONTROL PANEL OF A FORTY-KW. TUBE TRANSMITTER

Built by the General Electric Company for use in the station at Kahuku, Hawaii. This transmitter when installed will continue the radio link now in force between Hawaii and California. Another similar radio station competes with the cables to Japan and links Hawaii with Tokio

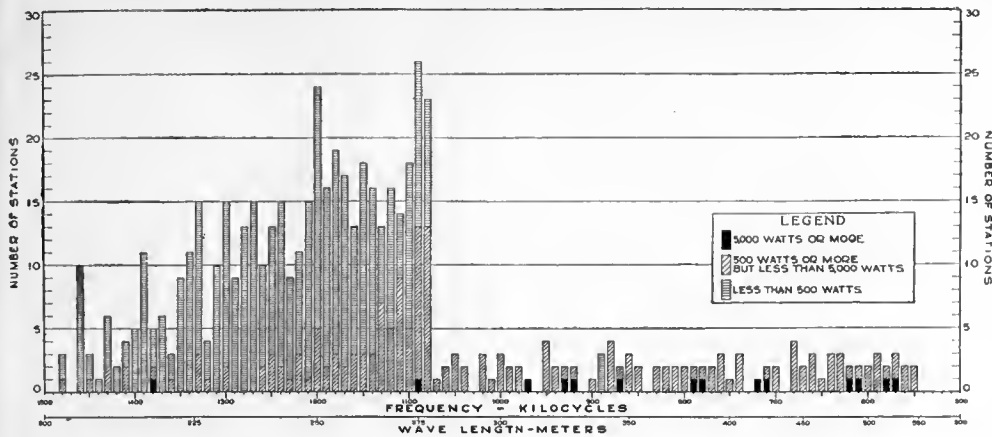

THE DISTRIBUTION OF BROADCASTING STATIONS IN THE UNITED STATES

On the first of November, 1925. This chart was officially compiled for the Department of Commerce. Note how comparatively few stations there are operating with a power of more than 5 kilowatts. Since the Fourth National Radio Conference, the number of stations has not increased. There are now 536 broadcast stations to supply aerial provender for the estimated four and a half million radio receivers

In a recent talk before the Society of Mechanical Engineers, Secretary Hoover expressed the opinion that Michael Faraday's discoveries were of such value as to "perform for us in one day more service than the whole banking community does in a year." Yet Faraday never received more than five hundred dollars a year, whereas the bank executive to-day never feels himself overpaid with a \$50,000 salary. Yet even now so little do we appreciate men with the Faraday point of view, that we spend for research and pure science only one tenth of what we spend for cosmetics. For every dollar the scientist spends to discover the truth, the women of the land spend ten to conceal it. But when such men as Mr. Hoover bring their influence to back up research in pure science then we are well started to fill the position in the world's scientific progress which our country is evidently destined to occupy.

A Note on the Langmuir Patent

A SHORT time ago we made a comment on the "high vacuum patent" which was issued to Langmuir, expressing our idea that Langmuir had not invented anything and that the issuance of the patent was a mistake on the part of the Patent Office. We are in receipt of a letter from Mr. F. S. McCullough, who has been associated with vacuum tube manufacture for many years, in which he agrees heartily with the ideas we expressed. This tube engineer has some old DeForest audions in his possession, he says, which show a higher vacuum than do the present Radio Corporation tubes. As long as facts such as these can be certified to by reputable engineers it is incomprehensible that the Court should sustain the Langmuir patent.

More Millions for Radio

IT SEEMS that some ambitious attorneys have persuaded R. A. Fessenden (well-known for his submarine signalling apparatus and patents on the radio heterodyne principle) that he has been grossly

swindled by some sort of monopolistic control in the radio industry and that by due legal process he might collect as damages \$60,000,000. It is very interesting to a college professor, with his rather modest income, to see how some of these radio inventors do juggle with millions. Their smallest unit of money seems to be about \$100,000, and to judge from the rumors extant, some of them have collected many units.

Fessenden really has been a very prolific worker in the radio field, one of his ideas, for example, being covered by the heterodyne patent. To hear a high-frequency current it must be combined with another current of nearly the same frequency, to produce beats. The first alternator of the type now credited to Alexanderson was built by Fessenden. He now claims that eight of the principal concerns dealing in radio have conspired to do him out of his just rewards and have not offered him a fair value for his invention. The attorneys' claims sound rather flimsy to us, but possibly the men who drew them up feel that there is some chance of collecting a little money for their client.

Who Invented the New Photo-Electric Cell?

IN THE same mail that brought criticism of our naval radio article came a letter from Mr. T. H. Nakken, criticizing our comments on the photo-electric cell which accomplished such remarkable effects at the recent electrical show. The new type of photo-electric cell was shown by Mr.

Zworykin, of the research staff of the Westinghouse Company. That company claimed the invention was theirs. Mr. Nakken informs us, however, that he patented this device several years ago and that full publication was made in England and France three years ago. "This," according to Mr. Nakken, "made it comparatively easy for the Westinghouse Company to invent the device."

So, with the aim of being fair, we cannot do less than publish Mr. Nakken's claim to this novel piece of apparatus. His patent in the United States was issued about a year ago, but was filed over five years ago. It may be that Mr. Zworykin has added something to Nakken's ideas, but on such a controversial point we can hardly enter in these columns.

Broadcast Listeners Organize

IN THE Middle West, the broadcast listeners have found it to their advantage to organize in order to improve the conditions under which they receive their programs. One such organization, the Broadcast Listeners Association of Indianapolis, reports an extensive program with the purpose of eliminating interference of all sorts. After only a short existence, the membership list has expanded to twelve hundred and the activities become quite diversified. The small membership fee proves sufficient to carry on what paid work appears necessary; certain trouble locating apparatus has been purchased and is regularly used by some of the members in finding out the reasons for poor reception.

According to a report recently released, meetings are held regularly, at which radio engineers generally give talks on interfer-



RADIO PRINCIPLES AT WORK IN THE POWER HOUSE

The so-called "storm detector" used in the power house of the Brooklyn Edison Company at Gold Street. The principle of the device is merely a simple application of the detection of static charges, which is ingeniously employed to ring a bell. With a warning of approaching storms, the power companies can prepare for the increased load that the darkness will cause

ence causes and their prevention; from three hundred to five hundred people have attended these meetings. A campaign against the single-circuit regenerative receiver is being constantly waged, while for those who still prefer to use this type of receiver, an educational series of talks on the proper and legitimate use of regeneration has been carried out.

A remarkable degree of coöperation has been secured from the public utility companies in Indianapolis and vicinity. A typical letter, from the superintendent of the Indianapolis Street Railway Company says: "This company stands ready to coöperate with the Broadcast Listeners Association at all times and will remedy any condition of its tracks or cars that might interfere with radio reception. We have already cleared up several bad spots that have been complained of by radio users." The telephone company and the electric power companies have similarly expressed their desire to remedy conditions which are pointed out by the Listeners Association as being detrimental to good radioreception. This association, it appears, is accomplishing a really valuable work for the listeners in Indiana.

### The Month In Radio

THE annual report of the Chief Signal Officer brings to light the fact that the army is now regularly using radio channels to carry on its routine business. A net of radio stations all over the country has been built up, the network comprising twelve major stations and sixty auxiliary ones. About eight hundred messages are handled each day over this network. In requesting more appropriation for development, General Saltzman states that if the communication which was effected through his radio chain had been handled by commercial channels it would have cost the government \$156,000. It is just possible that it actually cost the government more than that if the proper charges were made, but even so the radio chain is a valuable asset to our country, one that the Army should have available for emergencies in any case, even though it could show no saving at all.

FEW of us know enough about automobiles to care thoroughly for them ourselves; we depend largely upon the service man for inspection or repairs. Without the country-wide service of this character it is sure the automobile industry would not have grown as it has.

Now, in a lesser degree probably, the radio receiving sets of our country need the service man. But few of the listeners know the functions of the different parts of a set, but they would like to know that they are functioning properly. The "radio service man" is due to arrive. A group of repair and maintenance men, thoroughly familiar

with all ordinary types of receivers, could build up quite a clientele in almost any sizable town, we imagine. They must know the different sets and what they are capable of and how to remedy faults. It seems as though quite a lucrative business might be built up along this line and we expect to see someone do it.

As is frequently mentioned, the way of the inventor is long and tedious and he never knows whether his idea is safely his own or not. A case in point has to do with the modulation of the output of a vacuum tube oscillator. This scheme is used in every broadcasting station today. In spite of its universal application, no patent has yet been granted. White, of the General Electric Company, Hartley of the Bell Laboratories, and De Forest have been in a three-cornered argument for about eight years. After going through the normal Patent Office routine, the case went to the Examiner of Interferences, who gave De Forest priority. The Board of Examiners in Chief was then appealed to by White and Hartley and this board reversed the interference examiners' verdict and gave the idea to Hartley. Then De Forest and White appealed the case to the United States Court of Appeals and only now have the arguments before this court just been completed.

Even an older matter apparently still has to be settled. The Court of Appeals of the District of Columbia has just reversed a ruling of the Patent Office on Lévy vs. Armstrong, so that now Lévy is permitted to go ahead with interference proceedings against Armstrong, to whom the regenerative patent has already been issued. And in this same line it still remains to be settled, apparently, whether Armstrong or De Forest is entitled to the oscillating audion patent.

EACH year the work of the Bureau of Standards is inspected and reported upon by a Visiting Committee, made up of men not connected in any way with the Bureau but all of whom are closely in touch with the needs of our country as regards development and research. After commenting upon the great value to our country shown by the results of the Bureau workers (the report states that the automobile industry is saving \$155,000,000 a year as a result of Bureau studies) the committee emphasizes the great value of basic research—the kind that has no immediate apparent application.

It is the opinion of the committee that the Bureau work should tend in this direction more than it has done in the past. It is pointed out that private research laboratories are generally forced to work on certain questions having to do with special problems of the industry maintaining them and that these laboratories are not generally free to publish their researches. The Bureau of Standards, on the other hand, is maintained by the government for the good of all industries and so can most suitably attack those apparently unremunerative



A. ATWATER KENT

—Philadelphia; Radio Manufacturer—

*"Improved programs, I believe, will feature 1926 broadcasting to an even greater extent than was true in 1925. As a result of the Sunday night programs by world famous artists, that I was fortunate enough to arrange, I have found that the American public likes good music. They will get more of it during the coming year. Perhaps the two greatest fields for the development of radio in 1926, however, are its use on the farm and in education. Steps recently taken by Secretary Jardine to further radio service to farmers will prove of far reaching importance. The time will come when every schoolroom—city and country alike—will have a radio receiving set to supplement the work of the teacher in the class room. The new year will bring a big advance toward that condition."*

problems out of the results of which industry generally reaps rich rewards.

THE past year's report of the Commissioner of Lighthouses, just received, indicates the gradually increasing importance of radio signalling to the protection of ships approaching our shores. The very first paragraph, which is a long one, deals only with the new radio installations. There are now thirteen radio fog signal stations under his direction, one of them, installed on Lake Huron during the past year, being the first of its kind to be tried out on the Great Lakes. Equipment for fifteen additional stations (all outfits of the vacuum tube type) is ordered, six for the Great Lakes, one for the Maine coast, and the rest for the Pacific. We note that one of these is for Point Arguello, the scene of the Naval destroyer catastrophe. Certain improvements in synchronizing the signals from adjacent stations have been carried out and the fog signal station on Nantucket Light has been operated during the past year for fifteen minutes out of every hour to test the efficiency of the station in giving long-distance bearings for the incoming ships. No comments are made as to whether this service has been of appreciable value.

Important as we may think the radio fog signalling to be, it is actually a very small





GEN. CHARLES MCK. SALTZMAN  
—Washington; Chief Signal Officer—  
United States Army

*"While the technical advance in radio broadcasting apparatus for transmission and reception during the year 1925 has been confined largely to improvement in programs and wider dissemination of those programs as a result of the use of greater power and linked up stations, there has been much development in other fields of the art, principally in long distance telegraphic communication. The most outstanding advance in this branch of radio communication has been in the development of the short wave bands, where it has been demonstrated that on certain frequencies, with an insignificant amount of power and at small cost, communication has been conducted over greater distances that had hitherto been considered only possible of accomplishment with the extremely high power, long wave stations. I predict that in the coming year we shall see many improvements and novelties in the broadcasting activities. In the commercial field and as a result of the short wave developments, we may look for some revolutionary advances in radio communication and correspondingly increased use of radio for international correspondence."*

part of the total activity of this government department. For 1926 out of a total appropriation of \$9,700,000, only \$16,000 is allowed for radio fog signals. Of a total of 1207 fog signals, fog horns, submarine bells, whistling buoys, bell buoys, etc., only thirteen of them are radio stations.

The fog signal on the Ambrose Channel Lightship is a tube transmitter which has been operated close to the metropolitan district since April, 1924; the report comments on the fact that no complaint of interference has ever been lodged against this station. Had a spark transmitter been used, the government would have heard from a great many broadcast listeners, no doubt.

**WE** GENERALLY like to print reasonably accurate statements in these columns, but it seems that one slipped in a few issues back which hasn't the stamp of

dependability. Mr. William Dubilier, who makes a rather good living from mica condensers, was quoted as saying that in America the radio industry has grown so rapidly that it is now equal to the automobile industry.

Mr. Sarnoff estimates the past year's radio business as \$350,000,000, and he would not be inclined to understate the matter. *Motor Magazine* tells us that there was an increase in car registration in our country of 2,132,758 last year. So by combining Mr. Dubilier's statement and Mr. Sarnoff's estimate with the above figure we find that the average price of the new automobiles purchased last year was \$164.30! We must conclude that Mr. Dubilier's statement was open to question.

**A** PUBLICATION of the Bureau of the Census, dealing with the Farm Census of New Hampshire, gives the total farms reported as 19,895, of which only 2,366 had radio outfits. Evidently there is still plenty of market for good receiving sets.

*Interesting Things  
Said Interestingly*

**A** LMA GLUCK (New York; former opera singer and still well known on the concert stage): "Since the time a single record netted me sufficient to buy a private house on Park Avenue, receipts from royalties have fallen off precipitously, and all because of radio. The radio is a nuisance. They are perfectly darn foolish things to have around, and, besides the squawks, most of what one hears over the radio is terrible."

**H**UGH S. Pocock (London, England; editor of *Wireless World*):

"Wireless is still a new industry, and the design of apparatus associated with broadcast reception is passing through a stage of evolution. The steady development which is going on is not entirely the outcome of invention, but is more probably due to the stabilizing of an industry and the establishment of an improved manufacturing organization. It may be said that the manufacturer and the wireless enthusiast have rivaled each other in an endeavor to construct equipments possessing good selectivity, an extensive receiving range, with easy manipulation and the elimination of distortion. It must be admitted that a peculiar position has existed where prospective purchasers would exercise caution and seek advice before selecting a receiving set, and exhibit a hesitancy that would indicate a lack of confidence in the manufacturer. The exhibition this year indicates

that a change has come about and that the wireless trade is now taking a lead. It is now possible to select a broadcast receiving set built to a design that will not be rapidly superseded and with which the user will remain satisfied in spite of his technical interest in receiver design."

**J. J. WALSH** (Dublin, Ireland; Minister of Posts and Telegraphs):

"The science and practice of agriculture and horticulture will hold a prominent place in the items compromising the programs of our broadcasting stations, and it will be sedulously seen to that everything that wireless broadcasting can do will be done to inform and instruct the farming classes and to keep them in touch with current agricultural research.

Market reports, seasonable lectures, weather forecasts, etc., will be regular features of the programs.

Our news service we propose to make second to none, and how much this will be appreciated by our country people will be understood when it is remembered that they are insatiable gluttons for news. Their salutations are invariably followed by 'Bhfuil aon sceul agat?' ('Have you any news?')

**REV. DR. S. EDWARD YOUNG** (New York; in a sermon delivered at the Bedford Presbyterian Church, Brooklyn):

"We should encourage broadcasting stations and broadcasters to refrain, as far as possible, from conflicting with the usual hours of church worship. Since nothing can really take the place of the assembling of God's people in God's house, the time of their assemblage ought to be protected from needless rivalry or distraction. To be commended is a great broadcasting station for not starting its tremendous entertainment at night until after the sanctuaries have closed.

**DR. JOHN J. TIGERT** (Washington; United States Commissioner of Education):

"The benefits of hearing the best music are so great that I have always favored making it available to the greatest number of persons possible. Arrangement of programs such as the Atwater Kent series marks the attainment of an important milestone in this direction, because it will make a vastly greater number of Americans acquainted with the best music and the best musicians.



**IN THE MANUFACTURE OF FIXED CONDENSERS**  
The mica must be accurate in thickness. One degree on the large-scale micrometer in the photograph equals one one-thousandth of an inch

# Can We Forecast Radio Reception From the Weather?

The Results of Many Experiments Seem to Show That Weather Conditions Influence Radio Reception—Some Rules for the Amateur Radio-Weather Forecaster

By J. C. JENSEN

Nebraska Wesleyan University

MARK TWAIN is credited with the remark that although everyone talks about the weather, no one does anything about it. Thirty years ago when bicycle riding was all the rage among the young people, many a joy ride of twenty miles over country roads was suddenly turned into a weary tramp through the mud when an unfriendly thunderstorm got into action in mid-afternoon. Not long ago the newspapers carried accounts of automobile tourists who were marooned on the top of Pike's Peak by an early snowstorm, and of the loss of our famous dirigible, the *Shenandoah*, in an Ohio windstorm. It would be unreasonable to expect that radio, the latest "indoor sport," should be an exception and escape without any handicaps resulting from weather conditions. Radio reception has the advantage, however, that when J. Pluvius makes its use impracticable, the operator suffers no further inconvenience than the necessity of turning to the trusty phonograph or the piano for his entertainment.

The variations in radio reception may be grouped under three heads:

1. Irregularities in signal strength which persist for hours or even days at a time, resulting in clear reception from a given station on one evening and faint or inaudible response on the next. Such fluctuations are spoken of as changes in audibility.
2. Sharp, noisy, crackling sounds are called "Static."
3. A short period variation in signal intensity, the usual interval from one point of high audibility to the next being from three to five minutes. This is called "fading."

While we may not be able to "do anything about it," our purpose in what follows is to connect these three phenomena up with weather conditions.

RESULTS OBTAINED BY OTHER EXPERIMENTERS

ATTEMPTS to explain the variations in radio receiving conditions have been made constantly since the very beginnings of wireless transmission, but the tremendous increase in the number of persons owning receiving apparatus since the advent of broadcasting has resulted in a much more general interest in all problems affecting clearness and regularity of reception. Space will permit the mention of only a few of the most important of these experiments.

Dr. L. W. Austin of the United States Bureau of Standards has been engaged for several years in recording the signal strength of high-power, long-wave commercial stations such as Nauen in Germany and LaFayette in France. His reports show that transmitting conditions are more favorable at night than in the daytime and in winter than in summer. The amount of static disturbance varies greatly from day to day and is worst in the summer months. During the years 1920 and 1921, the American Radio Relay League in coöperation with the Bureau of Standards conducted an extensive series of investigations in which amateurs used their receiving sets to determine the audibility of signals under various weather conditions. They found that stronger signals were obtained when the radio waves from transmitter to receiver pass parallel to the isobars than when they move at right angles to them. [An isobar is an imaginary line connecting or marking places on the earth's surface where the barometric height, reduced to the sea level, is the same at a given time for a certain period.] It was found that stormy weather at the transmitting station does not affect the range or strength of the signals and that an area of clear weather connecting both stations results in less fading. Cloudy weather at the receiving station resulted in much more static than did clear weather. Our British cousins have recently completed a similar investigation and report conclusions in general agreement with those already given. They also found that the nature of the earth's

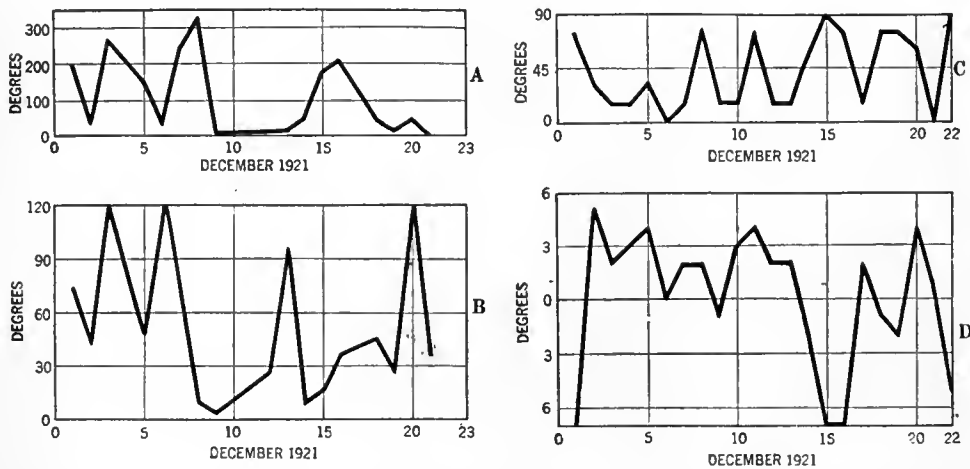

FIG. 1

Measurements of signal intensity variations of station NAA, the Naval station at Arlington, Virginia. Curve B shows the variations from night to night, during the first twenty one days of December in 1921. Note that, in B, on December 3rd, NAA's signals were 120 turns audible, while they were only four times audible on the 9th. Curve A indicates the static audibility for the same nights

FIG. 2

Signal intensity variations of NAA (operating on 113.1 kc., 2650 meters) for the month of April, 1922. Curve A shows the static audibility and B the signal variations. The maximum signal audibility for this month, as compared with December referred to in Fig. 1 is thirty. In December, the maximum was more than 300, while the static peak record here is 750 (Curve A), more than twice the December maximum. Curve A is static intensity. Curve B is audibility. In Curve B, Fig. 2, maximum audibility is 30 while in Fig. 1 Curve B, the maximum audibility is 120. Curve C, here and in Figs. 2 shows the angles made with the isobars of Fig. 3 and 4, by a ruler connecting Arlington, Virginia and Lincoln, Nebraska, on the map. Curves D (Figs. 1 and 2) give the number of isobars cut by the radio waves in passing between transmitter and receiver

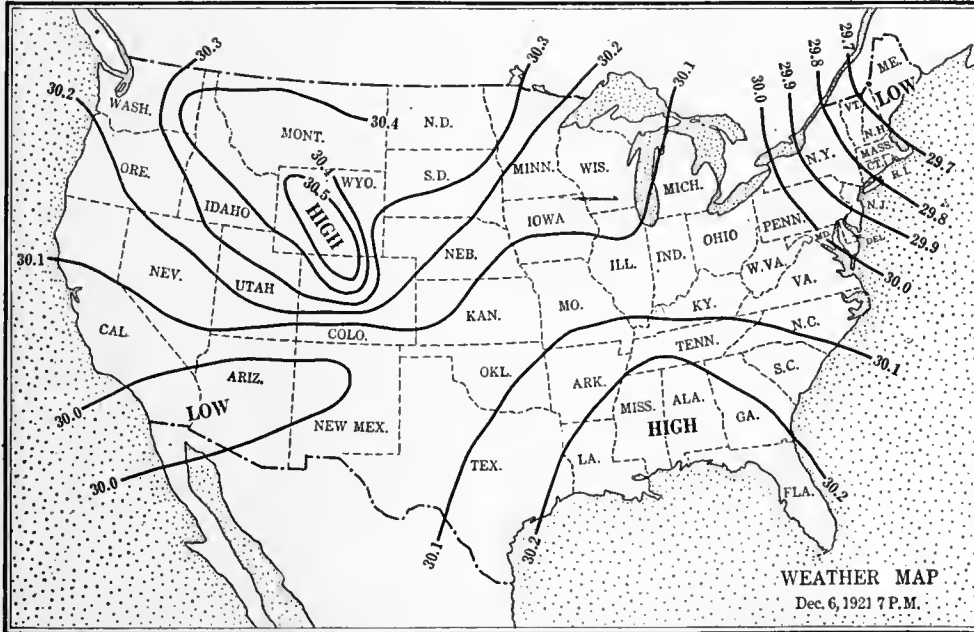
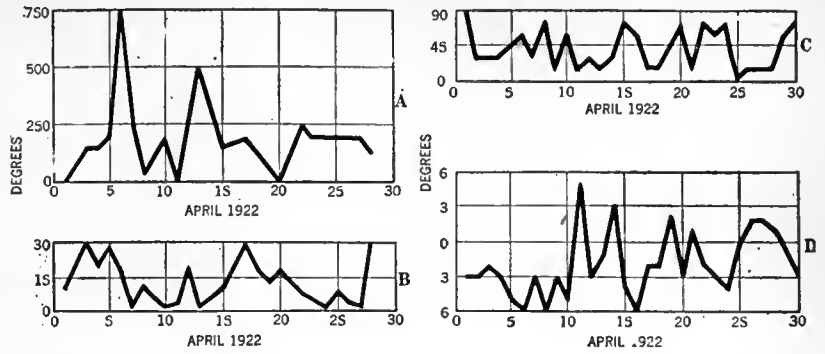

FIG. 3

The United States Weather Bureau map for one of the days covered by the curves in Fig. 1. Mr. Jensen explains the coincidence and relation of reception conditions with weather conditions in the article

surface in a given region influenced the strength of signals, water and mineral deposits being more favorable to good reception than sandy soil and rock. They further maintain that some signal variations attributed to fading are in reality caused by the antenna swinging in the wind and throwing the receiver out of tune.

Early in 1924, Dr. G. W. Pickard published an article on signal fading which presented the first satisfactory method by which the actual signal strength of radio carrier waves may be recorded. The curves obtained with his apparatus show rapid fluctuations in the carrier wave, the time between peaks and the amount of change varying from night to night. The same type of apparatus was used by Doctor Pickard and others in obtaining data concerning the effects of the eclipse of last January on radio signals. The results show a sharp rise in signal strength as the moon's shadow passed over the observer, conditions quickly returning to those normal for daylight work after the eclipse had passed. Further records made at sunset by a considerable number of observers during the summer of 1925, by the use of Pickard's method, show rapid fluctuations in the signal strength just after sunset, conditions becoming steadier and the

signals reaching night intensities about thirty minutes later.

One of the most interesting and widely discussed articles dealing with radio and the weather was that of Professor Van

Cleef in RADIO BROADCAST for May, 1925. This writer combined the observations of the lay observer of radio programmes with the technical training in weather lore of the climatologist and claims to have found a number of specific relationships between radio reception and weather conditions. The most important of these are that strong signals occur when transmission is at right angles to the isobars, or lines joining points of equal barometric pressure; signals are weaker, and fading is worse, when radio waves pass parallel to the isobars, and reception is weaker when transmission crosses from one pressure area to another. Before discussing these points in detail, let us turn to some recent experiments in the writer's laboratory.

RESULTS OF ACTUAL RADIO MEASUREMENTS

AMONG the most accurate and extensive records of signal strengths yet made are those by Mr. M. P. Brunig, a graduate student in the radio laboratory at Nebraska Wesleyan University, three years ago. The audibility of the time signals from NAA, together with that of static, was measured daily over a period of several months. A local oscillator gave a standard tone whose intensity could be measured by means of a thermocouple and a galvanometer. This tone was then used to measure the sensitivity of the ear

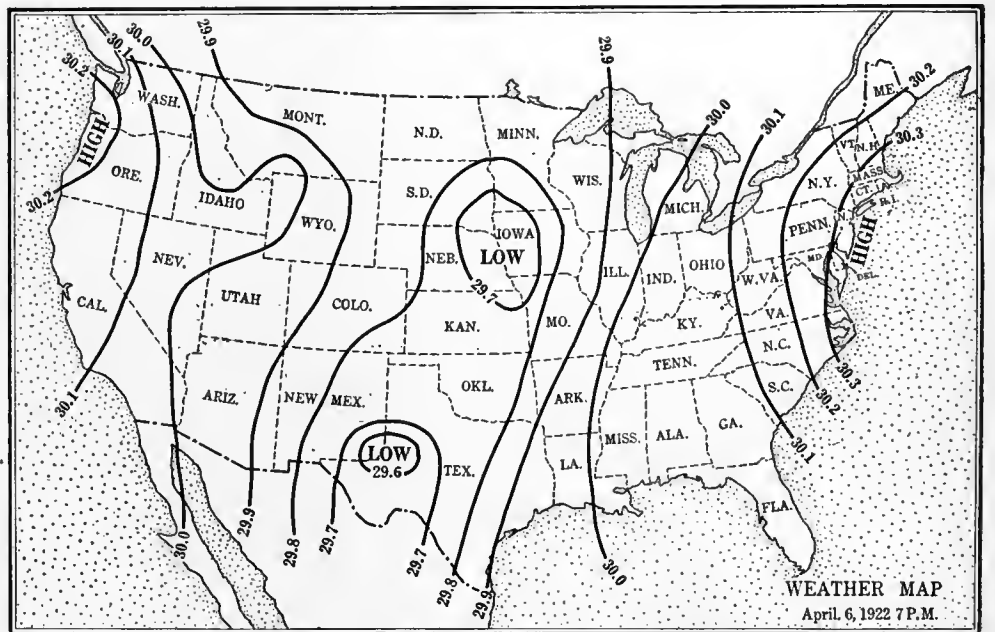

FIG. 4

Another Weather Map for the period covered in the curves of Fig. 2

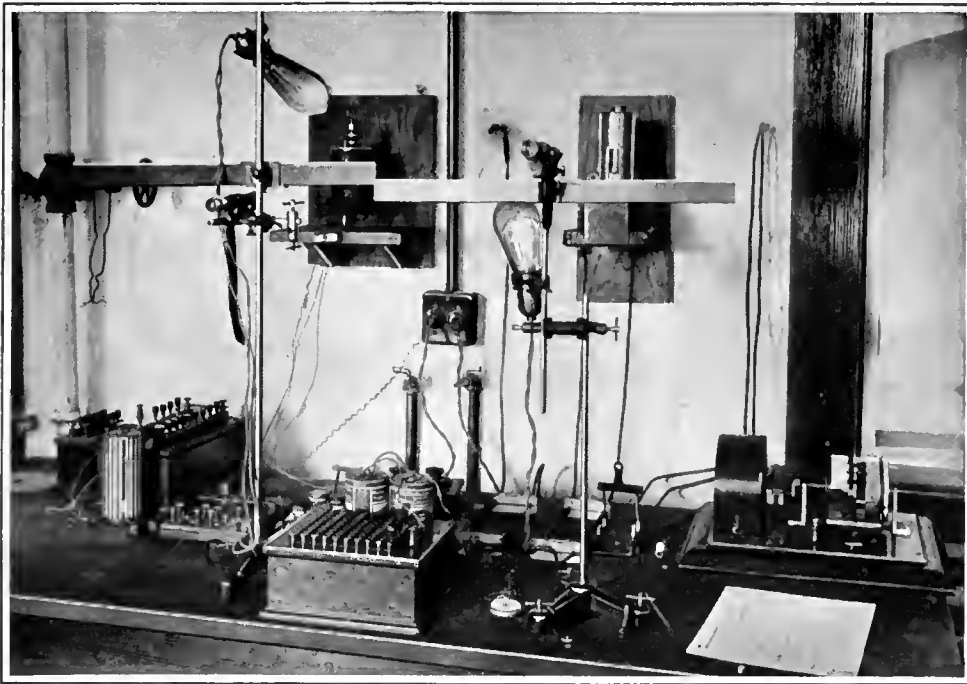

FIG. 5

The apparatus used to make the observations detailed in this article. The signals are received on a six-tube super-heterodyne. In the plate circuit of the second detector is inserted a fifth intermediate-frequency transformer. A head set is shunted across a .002-mfd. fixed condenser in series with the primary of this transformer. Shunted around this condenser is a sensitive wall-galvanometer (seen on the right side of the wall). In series with the secondary are a crystal detector and another .002-mfd. condenser. The field strength of broadcasters is accurately recorded with the galvanometer. The battery and resistance box in the foreground are used in neutralizing the small plate current of the uv-199 tube which has more recently replaced the crystal as a detector. To the right of the resistance box is a recording rain gauge and on the wall to the left of the galvanometer is a Compton electrometer, both of which are used for meteorological research

of the observer and to standardize the adjustments of the receiving set. A simple vacuum tube receiver with the necessary voltmeters and ammeters to check on batteries and filament current, and an audibility meter, completed the outfit. The original report on this research was

published in the *Monthly Weather Review* for December, 1922, but since the appearance of Professor Van Cleef's article we have gone over all the original observations together with the corresponding weather maps in order to study the relations of the weather conditions between transmitter

and receiver, and the observed signal strength. Curve B of Fig. 1 shows the remarkable variation in signal intensity from night to night, the data covering the first twenty-one days of December, 1921. Signals from NAA were 120 times audible on December 3rd, 6th, and 20th, while they were only four times audible on the 9th and eight times on the 14th. Curve A indicates the static audibility for the same nights and it is very evident that heavy static does not necessarily accompany weak signals, for on the evening of December 3rd, static was 260 times audible yet the signals were very loud. Ordinarily, however, strong and frequent crashes of static coincided with weak signals. Curves A and B of Fig. 2 give similar data for April, 1922. The maximum signal audibility for that month was thirty as compared with 120 for December, while the static peak record was 750, or more than twice the December maximum.

Many newspapers at present reproduce the daily weather map, so that if there is any simple relation between the directions of the isobars and radio receiving conditions, a few moments' study of the map should be sufficient for determining the radio probabilities for the evening. In Figs. 3 and 4 are shown two typical weather maps, chosen from the periods covered by the curves of Figs. 1 and 2. On December 6th, 1921, clear, fair weather prevailed all the way from the high barometer area in Colorado to the Atlantic coast. The entire distance from eastern Nebraska to Arlington, Virginia, lies between the two isobars marked 30.1 inches. Conditions on April 6th, 1922, were entirely different, with a storm area over Nebraska and Iowa and a high barometer region in the eastern states. A radio signal from Arlington to

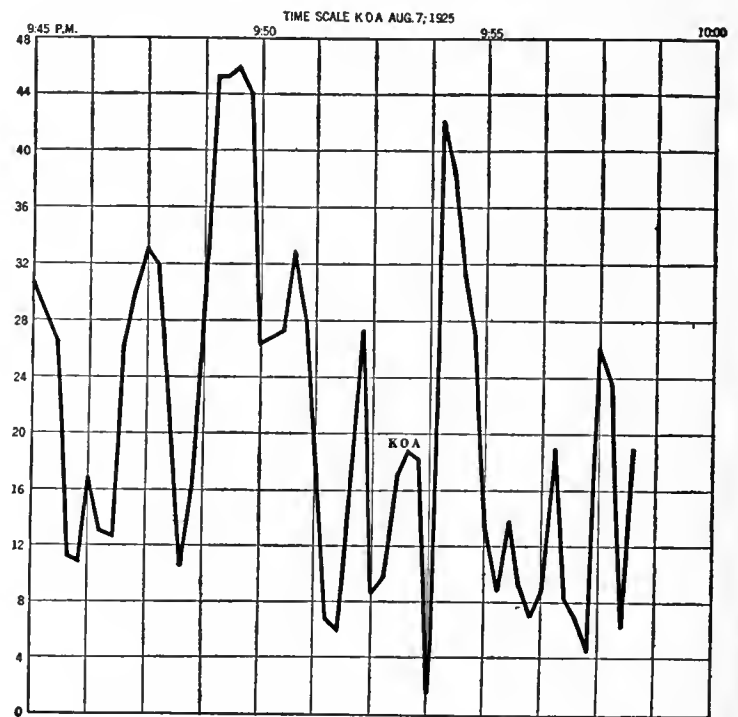
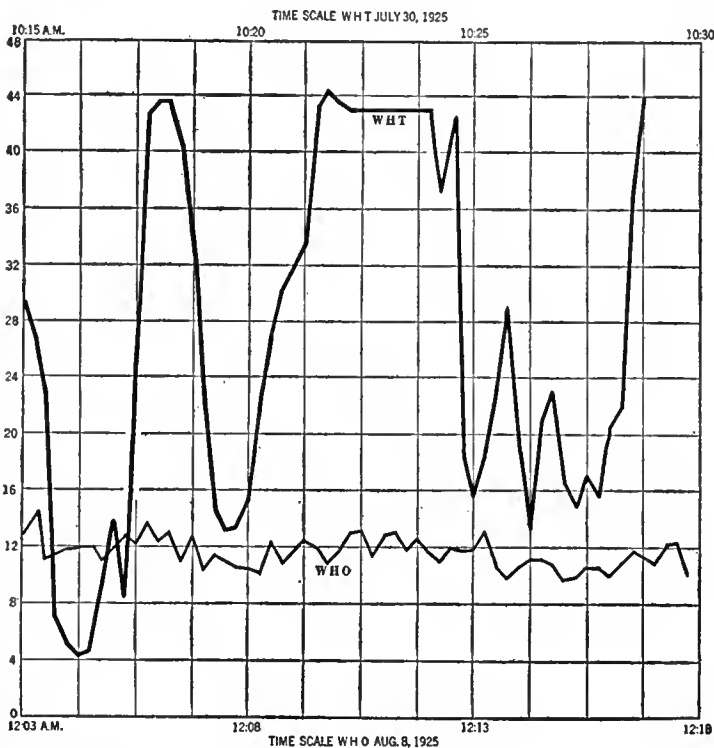

FIG. 6

Several representative curves on different stations, taken from a great many made by Mr. Jensen. Audibility is plotted on the left

University Place, Nebraska, must cross six isobars, pressures dropping from 30.3 to 29.7 inches. Curves C of Figs. 1 and 2 show the angles made with the isobars by a ruler connecting Arlington, Virginia, and Lincoln, Nebraska, on the map. On December 6th, this angle was 0° while on April 6th it was about seventy-five degrees. Curves D give the number of isobars cut by the radio waves in passing between transmitter and receiver, distances above the zero line indicating that the pressure was higher at the receiving end so that the waves must travel "uphill." From these studies, our data shows that *the highest audibilities are obtained when a ridge of high pressure extends from the sending station to the receiver.* Good results may also be expected when the waves travel at right angles to the isobars, provided they do not need to pass over an intervening low and up again. Poorest signals result from passing diagonally across the isobars or through a storm area. While these general rules apply to a majority of our records, it must be clearly understood that they are not infallible, and other controlling forces doubtless should be taken into account.

MEASUREMENTS OF STATIC

THE current in a lightning discharge is of the order of 5000 to 10,000 amperes, hence it is not surprising to find that electric waves produced by these crashes may travel for hundreds of miles. Measurements made in our laboratory show that an antenna or other insulated conductor may become charged to potentials of more than 5000 volts when a stormcloud is overhead and our sensitive apparatus records the smaller charges even before the thunderstorm itself is visible on the western horizon. In the northern hemisphere, thunderstorms are most common in the southeast part of a low area. These conditions prevailed in eastern Nebraska in the map of Fig. 4, and attention has already been called to the very high static audibility for that day. In high winds, and especially with drifting snow, the air often becomes electrified by wind friction, causing an antenna wire to take on a charge sufficient to cause sparks to jump across a lightning arrester to ground. Under such conditions the writer has known charges to accumulate of sufficient magnitude to be heard all over a large room as they jumped across an antenna condenser. The worst thing about these and other forms of static discharges is that the waves produced by them are scattered over a large number of wavelengths so that they are not easily tuned-out.

WHEN SIGNALS FADE

WHILE almost everyone who has used a radio receiver to any extent has noted the gradual variations in the loudness of program, special apparatus is required to measure

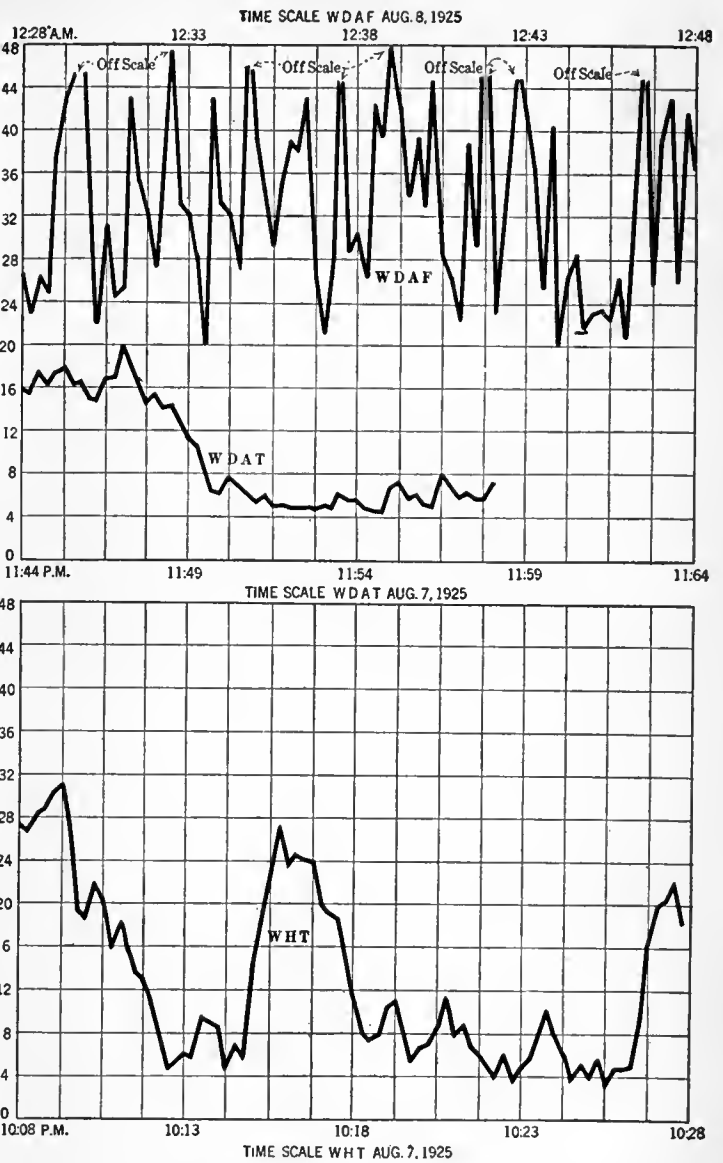

FIG. 7  
Time scale plotted against audibility on several stations on the night of August 7, 1925. The Weather Map below, (Fig. 8), shows the general conditions prevailing at 7 P. M. the same day

the actual changes in signal strength. The ear is not a reliable measuring instrument and tone impressions cannot readily be kept in mind for several minutes for comparison. Another difficulty lies in the fact that different parts of a musical program may vary considerably in loudness because of the character of the selections themselves, a change which has no relation whatever to true fading. The apparatus in use for making signal fading records in the radio laboratory of Nebraska Wesleyan University consists of a six-tube super-heterodyne receiver with vernier dials for tuning, and ammeters in the filament circuits. In the plate-circuit of the second detector is placed a fifth intermediate frequency transformer. A telephone head-set is shunted across a .002-mfd. condenser in series with the primary of this transformer, for use as a pilot in tuning and in following programs which are being recorded. In series with the secondary are a crystal detector and another .002-mfd. condenser. Shunted around this condenser is a sensitive wall galvanometer.

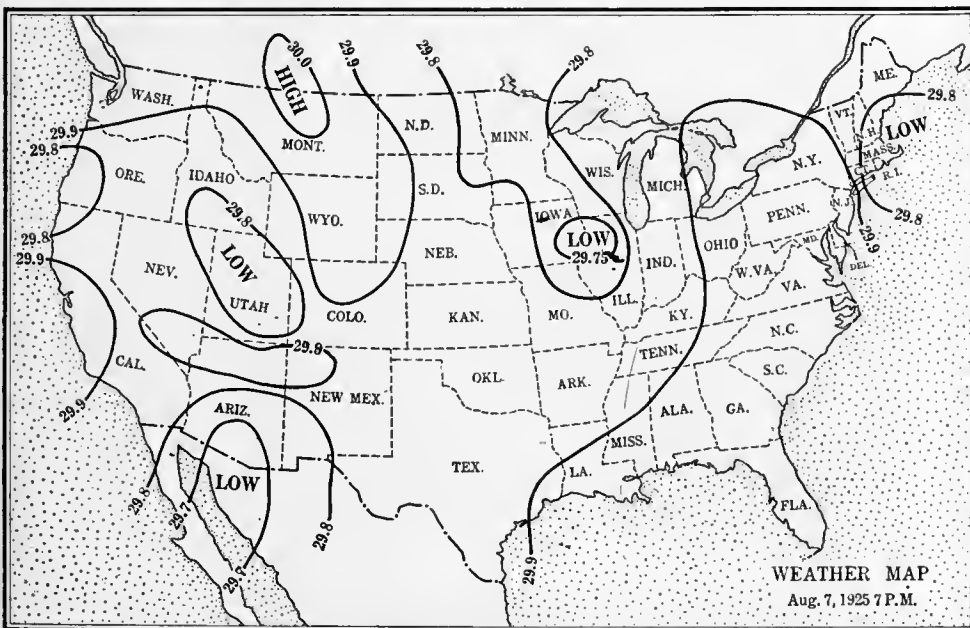

FIG. 8

meter as shown in Fig. 5. More recently we have replaced the crystal detector with a uv-199 tube and have also built up an automatic recording device somewhat similar to the Shaw Recorder used in Doctor Pickard's experiments. With this equipment, galvanometer deflections are proportional to the strength of the carrier wave and are not at all affected by the music or voice modulations heard by the radio listener.

In Figs. 6, 7, and 8, are shown a few typical records, chosen from the large number now on file. Three of the four curves in Fig. 6 are daylight graphs and give conclusive evidence that transmission is much more steady in the daytime than at night. The weather map for May 16 shows a marked storm area in the region of Lake Erie, with clear and settled weather over the great central plains. This accounts for the remarkably regular curve from WDAF at Kansas City. From WCCO at Minneapolis, on the other hand, some effects of the storm to the east are noticeable. The night record for WCX at Detroit is unusually regular, being obtained with a "high" in northern Minnesota, a "low" in Tennessee, and the intervening isobars running almost exactly parallel between University Place and Detroit.

Reference to the time scales on Figs. 7 and 8 will show that these records were all made on the evening of August 7, with the exception of that for WHT on July 30th. The midnight curve for WDAF contains the most rapid and violent changes of our entire series to date. While the period between peaks is commonly from four to six minutes, these are only ninety seconds apart, and continue the cadence with great regularity. This becomes all the more noticeable when contrasted with the records of WDAT at Chicago and WHO at Des Moines taken just a few minutes before. The graphs for WHT at Chicago and KOA at Denver, taken earlier in the evening, are typical mid-summer curves. The meteorological map for the evening of August 7th is reproduced in Fig. 9. The weather was hot and sultry, with no well-defined storm area in the plains region, a condition classed as "unsettled" by the meteorologist.

CONCLUSIONS

A DISCUSSION of the application of the data presented above to the Heaviside theory of radio transmission would be beyond the scope of this article. So far as it is possible to formulate an opinion based on actual observations, the

Eccles-Larmor theory which requires a refracting upper layer rather than an ionized, reflecting surface, agrees more nearly with the facts. There is strong evidence for definite relationships between weather conditions and radio reception although other factors, such as the earth's magnetic field, probably also play a part. The general conclusions supported by the data presented may be summarized as follows:

1. Signal strength will be greatest with settled weather conditions and transmission parallel with the isobars. (Fig. 3).
2. Good reception may also occur at right angles to the isobars unless a storm center intervenes between sending and receiving stations.
3. Static is most noticeable as a storm area approaches, the crashing noises being audible for several hundred miles; and the hissing noises prevailing only in the immediate vicinity of a "low."
4. Fading is much less troublesome in daylight than at night.
5. Fading is much more noticeable in unsettled weather than when transmission is parallel with the isobars along the ridge of a "high."

With these rules as a general guide, a radio forecast has been sent out daily at 4:30 P. M. from station WCAJ, since October 1st, 1925. While encouraging reports have been received, the project is yet in the experimental stage.

EDITOR'S NOTE

THE conclusions reached by Mr. Van Cleef, in his article, "Do Weather Conditions Influence Radio?" in the May, 1925, RADIO BROADCAST are reprinted below, so that experimenters can compare the findings of the two investigators. Mr. Van Cleef reached his conclusions from his observations without a great deal

of study of the radio theories advanced for variation in radio receiving conditions. Mr. Jensen has proceeded from the point of view of the radio investigator. Mr. Van Cleef's first point is in direct opposition to that of Mr. Jensen as he claims strongest transmission at right angles to the isobars. Mr. Jensen has found that loudest signals are to be heard in territories parallel with the isobars, along the ridge of a "high", with no difference in pressure between transmitting and receiving stations. This conclusion is also opposed to Mr. Van Cleef's second rule. With respect to fading, Mr. Jensen thinks that the worst fading is found with a "flat" barometer or large "low" area, while the third rule of Mr. Van Cleef assumes most fading on a ridge or parallel with the isobars.

1. If a line connecting the receiving station with the broadcasting station crosses the intervening isobars at right angles, reception is at its best.
2. The steeper the isobaric gradient (that is, the closer the isobars to each other) the stronger the reception.
3. The more nearly the transmitted waves approach parallelism with the isobars, the weaker the reception. Under these conditions, fading occurs.
4. Reception in a Low pressure area tends to be somewhat weaker than in a High of corresponding intensity.
5. Reception is weaker when the transmitted waves cross from one pressure area into another than when they travel only within one area.
6. The strength of reception for any station is a factor of both its location within a pressure area and its position with respect to the broadcasting station.
7. "Bad weather" does not affect reception, excepting as it may be the index of an unfavorable pressure distribution.
8. Reception can be as good in "bad weather" as in good weather if the pressure distribution is right.
9. Temperature does not influence reception, excepting as it may be the index of pressure distribution as follows:—
  - (a) Reception is better in winter than in summer because the cyclones and anticyclones are more intense in the winter period.
  - (b) Reception is better when temperatures are low than when high, because low temperatures usually indicate intensive High pressure areas, that is, areas with steep isobaric gradients.
  - (c) Low temperatures accompanying poorly defined High pressure areas make reception poor.
10. Shallow or flat pressure areas result in much static-noise in the receiver.

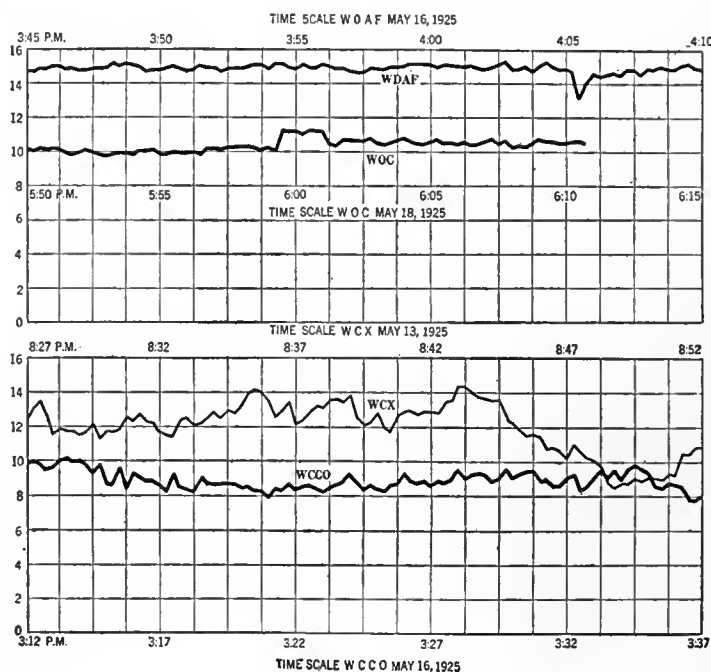

FIG. 9  
Some remarkable records of daylight reception during the spring of last year

# What Multiple Regeneration Can Do for Your Tuned R. F. Amplifier

*Suggestions for Experimenting with and Applying Multiple Regeneration to a Great Variety of Circuits with a Consequent Large Gain in Sensitivity—Details of the Circuit and Operating Suggestions*

By V. D. LANDON

*Radio Engineering Department, Westinghouse Electric and Manufacturing Company*

A GREAT deal of experiment has been spent in an effort to obtain the full amplification of regeneration twice or more times in the same amplifier. The average experimenter does not obtain the desired result, though the reason for failure is somewhat puzzling unless considerable study is made of the subject.

Take for example the well known Roberts Knockout Receiver. This circuit (with one stage of audio added) is shown in Fig. 5. If a station fifty to one hundred miles distant is tuned-in with this receiver, using zero tickler adjustment, a comparatively weak signal results while a 500- to 1000-mile station is usually inaudibly weak. Nevertheless when the tickler is advanced to the critical point, the gain in signal is sufficient to bring in stations well over one thousand miles distant and with full loud speaker volume. Only on poor nights or on very weak stations is difficulty found in obtaining sufficient volume for satisfactory reception.

On such occasions, however, imagine the thrill of having another tickler control capable of boosting the signal again by the same ratio! It was with this in mind that a great many experimenters tried the effect of unbalancing the neutralizing condenser in an effort to regenerate the antenna as well as the detector circuit. Also many have tried various schemes of feeding energy from the de-

EXPERIMENTERS in radio have tried for a long time to secure the undoubted advantages in sensitivity that multiple regeneration would give, but always there have been very serious practical obstacles in the way. This article, by Mr. Landon, who is an experimental engineer with the Westinghouse Electric & Manufacturing Company, at present attached to their offices in Springfield, Massachusetts, is in no sense a construction article. The basic principles of the system are outlined by the author, and they can be applied by the constructor to the particular receiver which he may have. The number of receivers employing tuned radio frequency amplifiers now in use in this country must be much more than five hundred thousand and the Landon method is applicable to all of them—it will add considerably to their sensitivity. The importance of the experimental field opened up by this article can scarcely be overestimated.—THE EDITOR.

tor back into the antenna circuit by inductive coupling. One such scheme was suggested by the technical staff in the April, 1925, RADIO BROADCAST.

Many of those who experimented along these lines thought they had achieved the desired result when they tried the set because it becomes very critical. An

adjustment of the tickler or the balancing condenser or of either tuning condenser, upsets the adjustment of one or more of the other three controls. However, a more critical receiver does not mean a more sensitive one. If a comparison is made between two sets using the circuit of Fig. 5, one of which is well balanced while the other has a variable neutralizing condenser, it will be found that there is very little difference in the sensitivity of the two sets. This is found to

be the case in any circuit in which an attempt is made to regenerate the antenna circuit by means of some form of coupling to a regenerated detector. Briefly the reason is this:

When energy is fed back through the tube capacity so as partly to regenerate the antenna, the tickler setting for critical regeneration is reduced, offsetting the gain in the antenna.

In other words, if the two circuits are somewhat coupled, both may be partly regenerated, but both may not be completely regenerated, since the system as a whole starts oscillating before this point is reached.

Before attempting the true solution of the problem, let us reduce the Roberts circuit of Fig. 5 to the equivalent four-tube circuit. This is shown in Fig. 2, Theoretically, the only difference between Fig. 5 and Fig 2 is that in Fig. 5 the first tube does the work of the first and third tubes of Fig. 2. In practice,



RADIO BROADCAST Photograph

FIG. 1  
By employing the Bremer-Tully three-coil unit, all the windings for the dual regenerator system are very simply provided. The rotor coil, pointed out in this illustration, is used as the radio frequency tickler coil while the adjustable coil and fixed coil are used as antenna and secondary windings respectively. The receiver pictured here was hastily assembled to conform with the principles of construction laid down by Mr. Landon in his article. It consisted of three tubes, namely, regenerator, radio-frequency amplifier, and detector. The coil unit shown at the left constitutes the detector secondary, tickler and r.f. plate circuit coil. The former and latter are both wound on the vertical coil form while the tickler is variable and is shown in a diagonal position

the circuit of Fig. 5 can be made equal to that of Fig. 2 only after considerable experiment. In presenting the multiple regeneration circuits, the circuit of Fig. 2 is used as a starting point because it is not subject to certain troubles which a reflex set may develop.

**THE BEST WAY TO ATTAIN INCREASED SENSITIVITY**

**T**HE solution of the problem is in regenerating each tuned circuit, all the while keeping the coupling between them to zero. Such a circuit is shown in Fig. 3. It will be found with this receiver that the advantage gained by using two ticklers instead of one depends a great deal on the completeness of neutralization. The more exact the neutralization the greater the gain in signal.

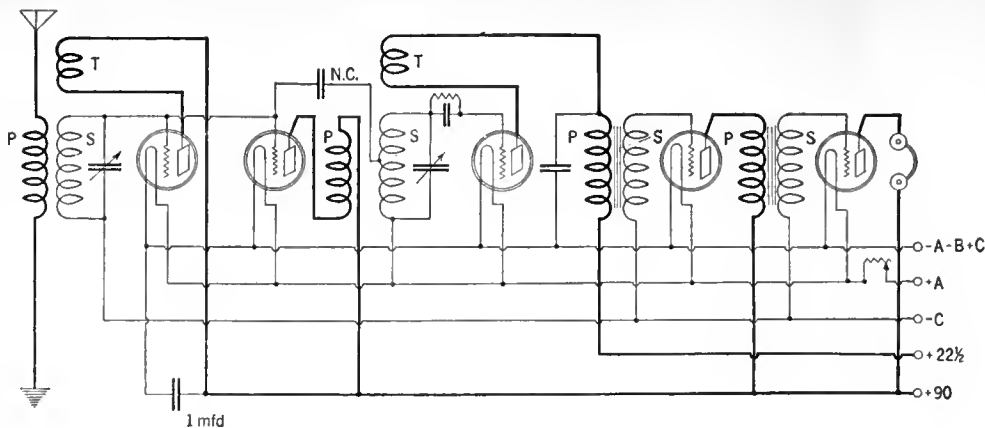

FIG. 3  
The Browning-Drake with regeneration added to the radio-frequency amplifier circuit

Notice that the change from the circuit of Fig. 2 is very slight. Another tube, and a small coil were added. A means of varying the coupling of the coil to the antenna circuit must be provided. The grid circuit of the new tube is the same as that of the first tube, that is, the two grids are tied together. However the plate circuit of the new tube is separate. It consists of the new coil which is used as a tickler.

Another method of controlling antenna regeneration is to use a fixed tickler with a variable resistor in series. A bypass condenser must be provided to bypass r.f. currents around the resistor. When the resistance is all "in", the voltage applied to the plate of the tube is insufficient for oscillation to occur. When the re-

sistance is gradually cut out, the point of critical regeneration is approached until finally oscillation occurs. When the set is properly constructed it should be possible to start or stop oscillation at any wavelength with this resistor. There are several good resistors for this purpose on the market, which have a range of 10,000 to 100,000 ohms such as the Royalty, Bradley, Centralab, and Clarostat.

It is also possible to control the antenna tickler by any of the commonly used methods. A coil having the same value as the secondary coil may be substituted for the variable resistor and a variable condenser shunted around this coil for tickler control. Or the tickler lead may go directly to the B battery terminal with a separate (vernier) rheostat on the first tube for regeneration control. In this latter case the tube filament brilliancy is turned down to the point just below the point of oscillation. This is a very simple and effective system.

For ordinary reception, the first tube may be left out of the socket, the set being used like the standard Roberts Circuit. However, when a signal is found which cannot be brought up to the desired volume,

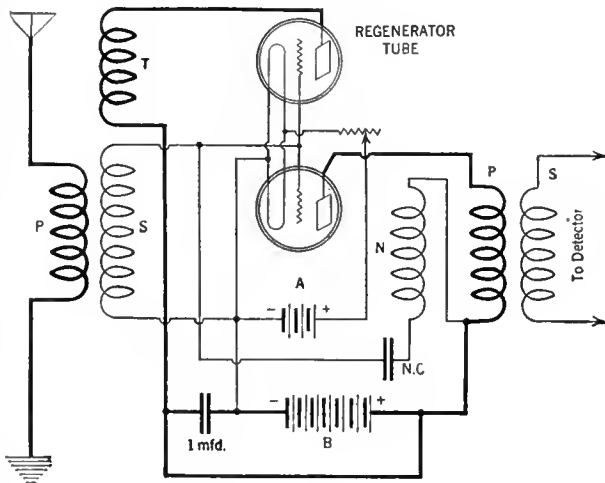

FIG. 4

Here are shown the important parts of the usual radio frequency circuit to which has been added the extra tube whose grid is paralleled with that of the first tube and whose plate return is made through a coil coupled inductively to the first secondary and thence back to the B battery. Notice that in all the circuit diagrams accompanying this article a 1-mfd. condenser connects from the plus B to the minus A lines

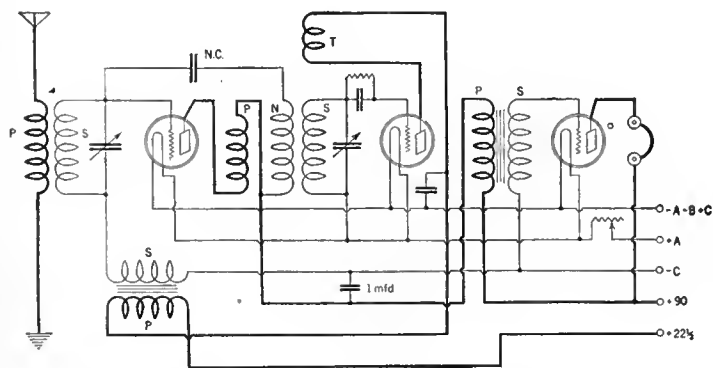

FIG. 5

The regular three-tube Roberts receiver consisting of one stage of tuned, neutralized, radio frequency amplification, a regenerative detector whose output is reflexed back to the first tube and thence followed by a straight audio stage

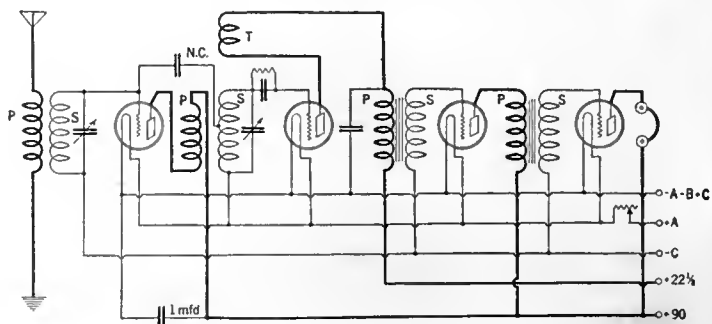

FIG. 2

This is the Browning-Drake circuit, familiar to readers of RADIO BROADCAST as one having excellent tuning qualities

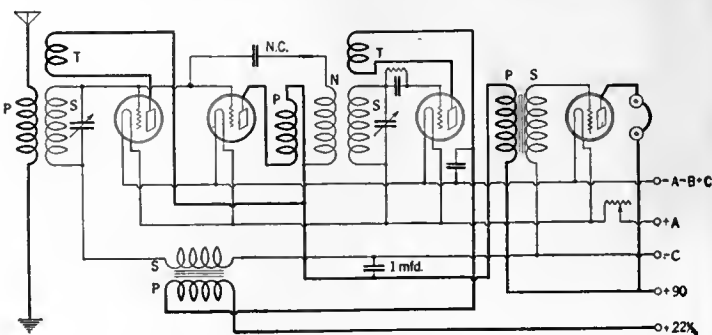

FIG. 6

The Landon system of r.f. regeneration added to the reflexed Roberts circuit. In the article, this is used as a basis for a discussion of the merits of dual regeneration



a great gain in signal is to be had by inserting the tube and adjusting the antenna tickler to the critical point which is just below the oscillating point.

It is also very easy to provide a filament switch to cut in the tube when it is needed, but for those who are not so particular about the filament current used, it is perfectly practical to leave all five tubes lighted whenever the set is in operation. The extra tube will have no effect on the circuit as long as the antenna tickler is set at zero, and of course, this control should not be used until necessary, since the receiver will radiate when the antenna circuit is caused to oscillate. There is no point in

### Facts About the Circuit System

#### Material required for regenerator stage:

One socket, one tube, one tickler coil, a rheostat and filament switch.

#### Values of parts employed in the Circuit:

No definite values are stipulated as it is desirable for the builder to select for himself the size of tuning coil and condenser he wishes to cover the frequency range in which he is interested. The bypass condenser across the primary of the first audio stage should be .001 mfd. For the tuning coils, the ratio of primary to secondary should be 1 to 4 for the antenna circuit and 1 to 3 for the detector. The tickler coil should have  $\frac{1}{2}$  the number of turns of the secondary coil to which it is coupled.

#### Operation:

When first tuning for a station, keep the regenerator tube unlighted. When the distant station is tuned-in and it is desired to increase sensitivity, turn on the filament switch of the regenerator tube and slowly advance the coupling between the regenerator tickler and the antenna secondary coil. Do not attempt to regenerate up to or beyond the oscillation point which manifests itself by a raucous squeal. Always employ the regenerator as a reserve of sensitivity and power.

#### Important points to remember:

A large bypass condenser, such as a 1-mfd. should connect from the B battery terminal of the new tickler coil direct to the minus A; the secondary coils for r. f. stage and detector should be placed at exact right angles to each other.

get down to the much discussed static level except on unusually quiet nights. In other words, those broadcasting stations whose signal intensity is higher, or stronger than the static intensity—otherwise termed static level, have a very fair chance of being tuned-in with the aid of the extra

control. Those below the static level have not this possibility. Briefly, a receiver employing this regeneration system has all the sensitivity for which there is any use.

control. Those below the static level have not this possibility. Briefly, a receiver employing this regeneration system has all the sensitivity for which there is any use.

#### THIS SYSTEM HAS WIDE APPLICATION

OF COURSE the main idea of Fig. 3 can be applied to practically all circuits employing tuned radio frequency

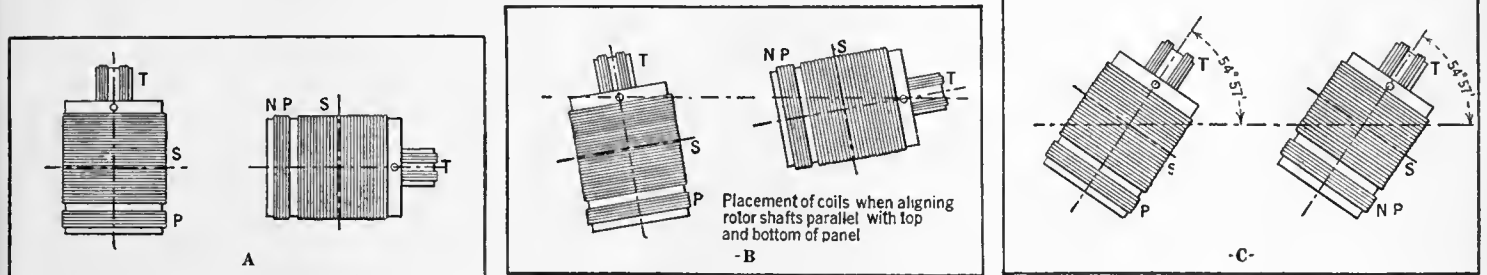
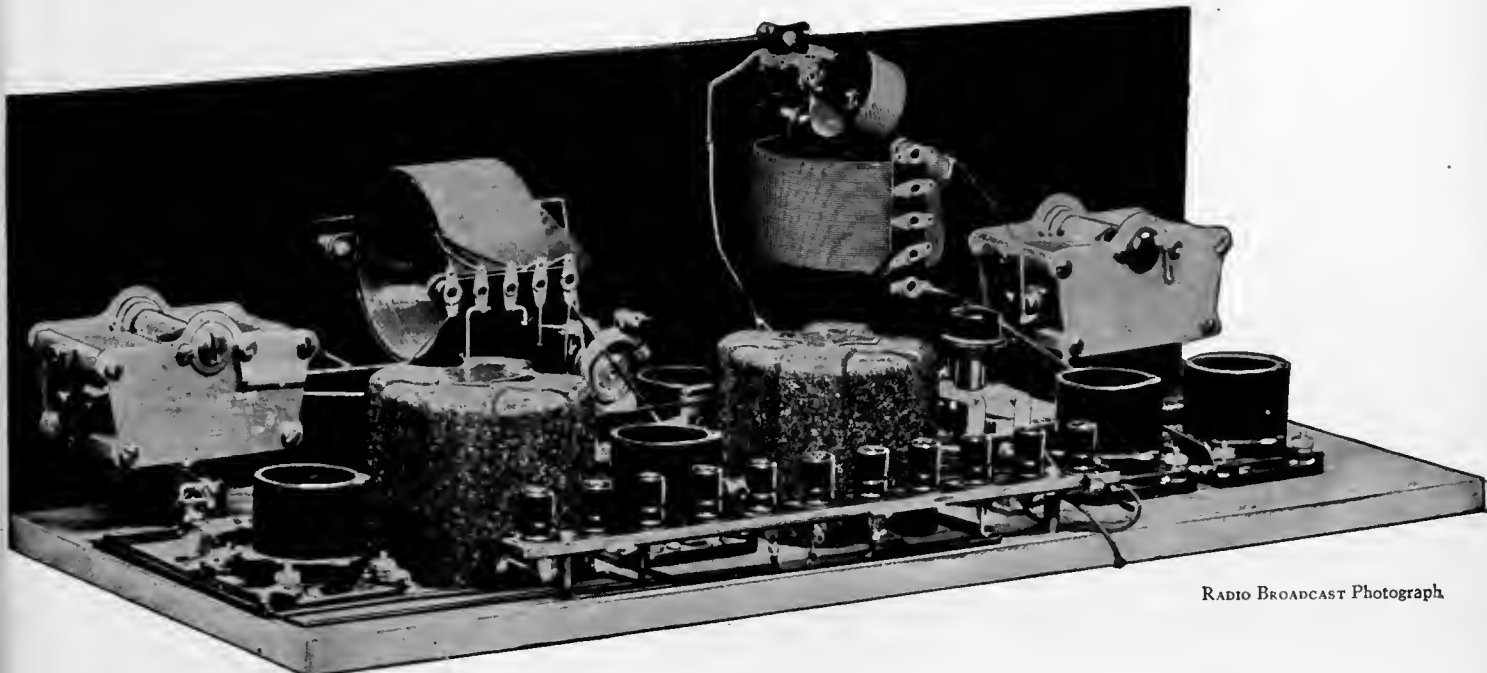

FIG. 7

To obtain satisfactory neutralization of the radio frequency amplifier, it is first necessary to de-couple the tuning coil units to prevent any undesirable feedback or inter-coupling effects which are not helpful. Here are shown several ways of placing the coils to obtain the desired effect. In A, the secondary coil axes are at right angles to each other; in B the condition prevails excepting that the two coil units have been shifted so that the rotor coil mounting holes in the panel are on a straight line parallel with the top and bottom edge of the panel. This is only where uniformity and symmetry of panel layout is desired. In C the angle of coil placement, 54°—57° made prominent by incorporation in most neutrodyne is shown. Here it is desirable to have the coil centers placed not less than 6 inches apart



RADIO BROADCAST Photograph

FIG. 8

The rear view of a receiver employing dual regeneration constructed solely for experimenting. Note that the secondary coils of each tuning unit have their axes at right angles to each other. This is an absolute necessity where a positive neutralization of the radio-frequency amplifier is to be obtained

amplification. For the lovers of reflex, Fig. 6 is given. Notice that the first two tubes act in parallel at both radio and audio frequency. This circuit could easily be made from the Roberts Circuit as the only changes necessary are the addition of a tube and the tickler coil. Then there are the thousands of neutrodyne receivers to which this system is admirably adapted.

Fig. 9 shows a two-stage tuned r.f. amplifier in which regeneration can be obtained in two places. The neutralization of the first stage is variable so that the antenna can be regenerated by capacity feedback. The detector circuit is regenerated by means of a tickler as usual. There is coupling between the first two circuits, but the coupling between the detector and the other two circuits must be kept as near zero as possible.

Fig. 11 shows a two-stage amplifier in which regeneration occurs in three places. In view of the foregoing, the diagram is self explanatory.

In practice, the circuit of Fig. 11 would be extremely hard to balance accurately enough to operate satisfactorily. By using separate batteries on each stage and by separating them by several feet, it could probably be done, though the sensitivity would be greater than is ever necessary, except perhaps for long distance daylight reception. Probably, the most practical circuit employing multiple regeneration is that of Fig. 3.

It is not the purpose of this article to give exact constructional details for this set. Individual constructors will have their own ideas as to what the panel layout should be, since each will incorporate different varieties of apparatus. However, it will be necessary to keep in mind certain points, if the set is to work properly.

The coils must be low loss for good results. The lower the resistance the greater

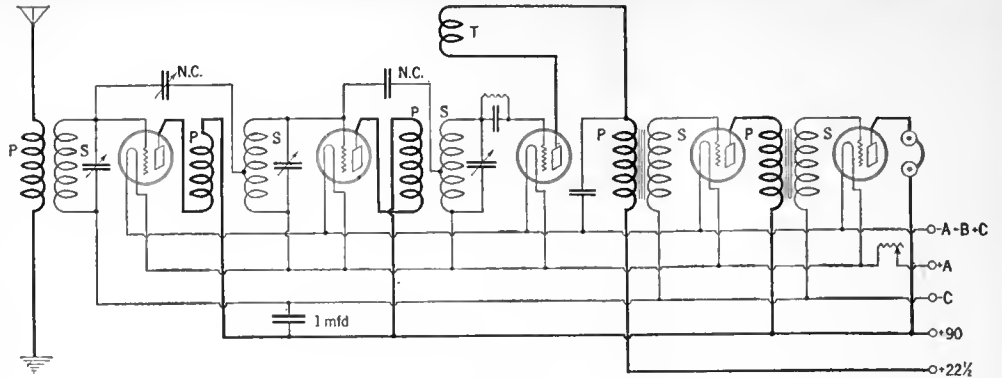

FIG. 9

The standard neutrodyne circuit employing a regenerative detector. To this circuit may be added the radio-frequency amplifier regeneration system shown in Fig. 4

the sensitivity, even when full regeneration is employed. The effect of resistance in the grid circuit of a regenerated system is thoroughly discussed in December, 1925, *Proceedings of the I. R. E.* "An Analysis of Regenerative Amplification" by the writer and K. W. Jarvis.

The two grid coils may be any of the well known low loss designs, so long as the broadcast range can be covered with the variable condensers used. The following may help in choosing the type of winding.

#### CHARACTERISTICS OF THE BEST COILS

THE Lorenz or basket weave coil has fallen into disrepute among the exponents of low loss lately. Nevertheless it is about as good a coil as can be made in a given small volume. In general, however, coils wound on tubing are better because they are larger. The chief losses in the Lorenz type of winding are due to eddy currents in the wire itself caused by the magnetic flux from adjacent turns. This loss is reduced to a minimum by using large diameter coils and a spaced winding. The larger the volume which is to be oc-

cupied by a coil the larger the wire that may be used with advantage. Number 24 wire (B & S Gauge) is about right for a coil three inches in diameter. No. 16 wire is better if the coil diameter is in the neighborhood of six inches.

The effect of the average type of tubing in the field of the coil is negligible in dry weather or immediately after a coil is thoroughly baked. However, the resistance of a coil may be multiplied by three or four in wet weather if proper precautions are not taken to keep the moisture out. The coil may be made moisture proof by treating it with a good coil varnish such as Sterling Copal varnish. The coil should be baked dry, then dipped in the varnish and baked again. Painting the outside of the coil with varnish is not sufficient, since moisture will be absorbed by the inner surface of the tubing. Of course collodion will do the trick but it is rather expensive. Celluloid sheets dissolved in acetone to a consistency of shellac or varnish also is effective as a coil binder.

All coils, such as primary windings and ticklers, which are not a part of the tuned circuit, should be wound with very fine wire such as No. 35 d.c.c. The resistance of these coils in themselves is not important, but if large wire is used in them the resistance of the tuned circuit to which they are coupled is increased, and this causes a reduction in efficiency.

It is well to remember that this article does not deal specifically with the construction of a receiver but rather explains the application of a regeneration control system to existing receivers.

The ratio of primary to secondary winding should be about 1 to 4 in the antenna circuit and about 1 to 3 in the detector circuit. Each tickler coil should have about  $\frac{3}{8}$  the number of turns of the grid coils. Remember that it is necessary to neutralize the coupling between the tuned circuits almost perfectly if any gain is to be noticed from multiple regeneration. This means extreme care to place the coils at right angles or as shown in Fig. 7 in order to prevent inductive coupling. It will be noticed also that any metal in the field of either coil may distort the field so as to cause coupling even when the coils are at right angles. Adjustment of the capacity balance (neutralization)

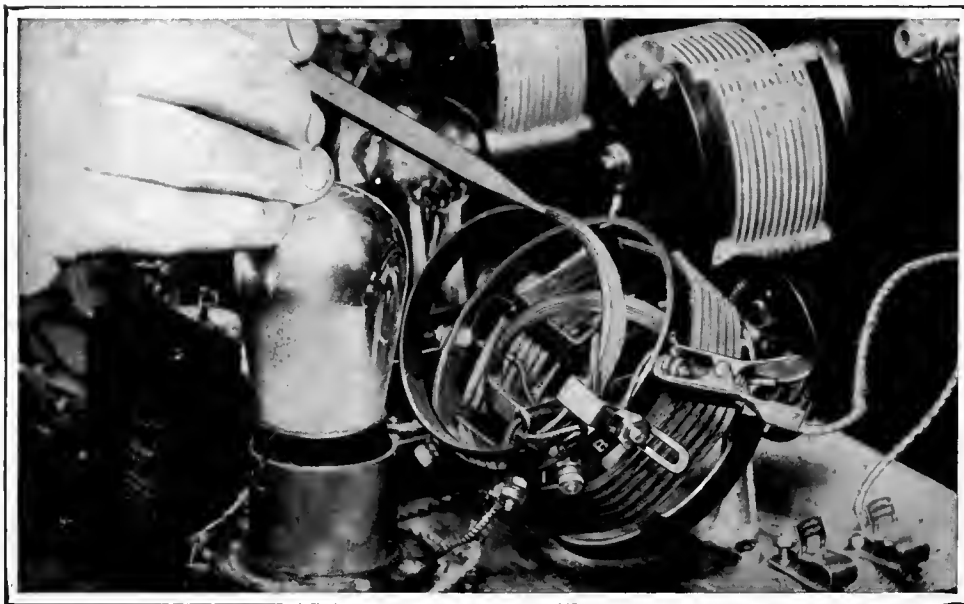

RADIO BROADCAST Photograph

FIG. 10

The pencil points to an adjustable antenna coil which aids greatly in obtaining the correct coupling between antenna primary and secondary circuit of the radio-frequency amplifier. The additional tube, which functions in the dual regenerator part of the circuit, is located directly behind the Bremer-Tully coil unit

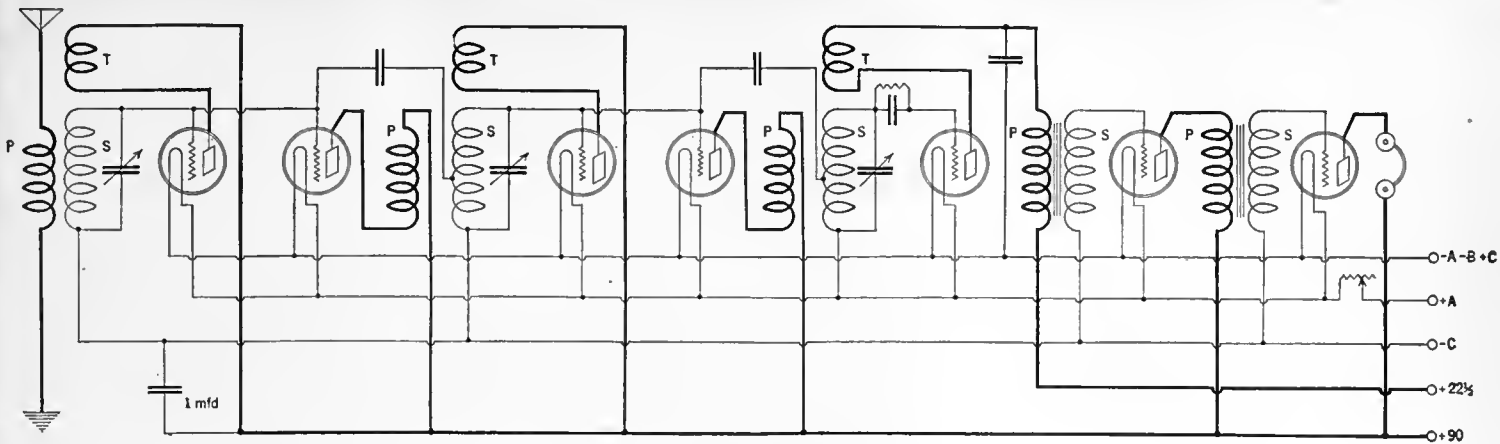

FIG. 11

Three ticklers for two r. f. stages and the detector. An hypothetical case of applying the Landon regeneration system to the neutrodyne receiver. It is unlikely that in this instance much will be gained by its use because of the extremely critical tuning which will result. Two ticklers, one for the second r. f. stage, and one for the detector, would be the more practical application of the Landon regeneration system.

should need no explanation. Let it suffice to say that the adjustment should be made as accurately as possible.

But for those who are incorporating this system in a new construction, it is assumed that neutralization has not been obtained, therefore the following memorandum on neutralization will be helpful.

Maintaining zero coupling between the first secondary and the radio frequency tickler coil, the detector tickler is advanced to cause regeneration in that circuit. Previous to this, the receiver should be tuned to some station which responds at the half-way point on the tuning dials. The squeal produced should not be made too loud. Rotate the antenna-secondary tuning condenser over a small arc. If the pitch of the squeal varies, then the set is not properly neutralized. The capacity of the neutralizing condenser employed in the circuit should be varied a little at a time until the pitch of the squeal does not vary. Then the receiver may be considered neutralized. The constructor should not confuse squeal intensity with squeal pitch.

**BEST APPLICATION OF THESE EXPERIMENTAL SUGGESTIONS**

**A** NOTICEABLE gain in selectivity will be obtained if no part of the set is grounded except one end of the antenna coil as shown in all the circuits printed with this article. This is especially effective if all battery leads are kept short.

Of course all the usual precautions should be taken. To avoid apparatus of poor design, buy only well known makes of apparatus when purchasing such items as sockets, rheostats, grid leak, variable condensers, transformers, tubes, etc.

To aid in neutralization, keep all grid and plate connectors as short as possible. Run the leads to the neutralizing condenser in as short a line as possible. Do not omit any of the bypass condensers shown. Those shunted across the primary of an audio transformer should have a capacity of about .001 mfd. The condenser across the B battery should be about 1 mfd.

To avoid bad joints and leakage losses, use rosin core or soft wire solder in wiring the set. All battery leads should be cabled if they are close together for a considerable distance in a set. This will avoid closed loops.

It should be kept in mind that all the multiple regeneration circuits shown in this article are capable of oscillating into the antenna. This is true of any r.f. circuit employing a means for neutralization and where the neutralization is not perfect. Care should be taken not to cause such oscillation at any time, since interference to neighboring receivers is the inevitable result. This is readily accomplished if the receiver is tuned as follows, which is the easiest and most natural method.

Leave the antenna tickler at zero or nearly so, and operate the set in exactly the same way that a Roberts Knockout Receiver is operated. Occasionally a signal will be found which is too weak to be brought to the required volume by this method. The antenna tickler should then be brought up to the critical point, after the other controls are properly adjusted. If oscillation should occur, it will be immediately apparent to the operator who should back off the control at once.

The circuit of Fig. 3 is especially recommended to home builders as it is the simplest and most practical of the circuits shown. It is believed that any one who completes it will be well pleased as it is a wonderful performer.



RADIO BROADCAST Photograph

FIG. 12

Adjustment of the neutralizing condenser is an important procedure in the correct operation of this receiver. John B. Brennan, Technical Editor of RADIO BROADCAST, is shown here making this adjustment in RADIO BROADCAST Laboratory

# AS THE BROADCASTER SEES IT

by CARL DREHER



Drawings by Franklyn F. Stratford

## Putting the Listener Under the Microscope

SOME years ago, in a moment of despair, I proposed the establishment of a broadcasting station to be operated for the pleasure of the engineers alone, in vacuum, so to speak. In this way the cares of the program directors, engineers, announcers, artists and other functionaries would be marvellously reduced. They would be kinder to their wives and children, and suicides and murders would be less among them. The ceaseless tension of the broadcasting business would be relieved, and professional broadcasters would become as carefree as shepherds on pleasant summer afternoons. I can see them going around playing joyfully on little pipes, the operators fraternizing with the announcers, all hands looking ten years younger, gaining weight, and enjoying life. And all through the elimination of the listeners. The method I suggested was to run the station without an antenna. Thus no one would have to worry about what went out, nor how it sounded, because no one would listen to it but the station staff, and they wouldn't give a continental.

This is a dream with which I please myself once in a while. For, in the hard world of reality, the listeners crack the whip over me and all my colleagues in the various divisions of the broadcasting business. They make and break us. Please them we must, or we don't eat—unless we give it up altogether and become garbage collectors and hosiery salesmen once more. One should give prolonged consideration to fauna of such importance to one's welfare. Therefore we shall devote a portion of this department, without further delay, to a discussion of the listener, testing his reactions to various acids and alkalies, purifying and educating him, and giving him praise where due, but nowhere else.

In the course of business I recently had occasion to make a journey with a United States Supervisor of Radio, a gentleman who is a philosopher as well as an administrator. During our talk he commented on the remarkable contrast between the perfectly supine reaction of many citizens to the avoidable evils of existence, and the fearful how-dy-do immediately raised when something goes wrong on the radio. An automobilist will sit almost motionless at the ferry landing for four hours, on Labor Day or some other holiday, waiting his turn to get on the boat, with scarcely a murmur. If he lives in a big city, he will submit himself and his womenfolk to the most inordinate crowding in their daily journeys about the town, without batting an eyelash. He allows himself to be robbed by hatcheck boys, abused by the traffic

cop when his car slides two inches over the line, and to be told by conventional imbeciles that he must not wear his straw hat after September 15th. None of these injuries is inevitable. Wharves, bridges, and subways may be built to accommodate peak loads, a posse of public-spirited citizens could lynch a hatcheck boy and duck one of the over-eloquent traffic directors, and the bitter-enders among the straw hat wearers could free themselves by marching to the Polo Grounds in a body on September 25th and shooting down the first hoodlum who threw a pop bottle at them. My remedies are a trifle radical, and all the readers of this law-abiding periodical will not agree with them, but there can be no debate about the underlying thesis. In all these situations, and a multitude more, the people stand for anything. But not in radio! Just let some foreign freighter open up on 450 meters during a concert, and twenty irate listeners sit down and write a letter to Secretary Hoover. The more moderate ones get after the Supervisor, but there are always some for whom nothing less than the Secretary will do. The Secretary must suppress the amateurs, brush the cobwebs off an ill-managed station's carrier, stop XXX from air advertising, and torpedo the Jugo-Slovakian merchant marine. He must do these things right away, or Richard Roe and John Doe will rise agin the government.

Here is an actual instance. A large broadcasting station was set up at a point 30 miles from New York, the location having been determined by careful tests and calculations. New York has a lot of suburbs, and inevitably some of them were and are (for neither the towns nor the station have been moved) much nearer the transmitter than that. When the station started testing, after only a day one gentleman, a lawyer, sat down and wrote a long petition to Secretary Hoover. He is quite a prominent lawyer and writing 1200 words must have cost him a neat sum in time and energy. It seems he had an eleven-tube neotrodyne, which, as he was a lawyer and had made it himself, was absolutely perfect, and with the near-by station going he could not hear one in Chicago which he had to hear, or die, so there was nothing left but to write the Secretary. As a matter of fact, in about half the time he spent in dictating that epistle he could have rigged up a wave trap which would have solved his problem. The company which put up the station knew that a wave trap would take it out in all the near-by towns when it wasn't wanted.

I do not mean that all the listeners are chronic kickers. Most of them are amiable and appreciative souls, or else the martyrs at the broadcasting end of the circuits would all have eaten rat poison by this time. For instance, in the case mentioned above, after a brief period of testing, some 1500 letters were received, of which thirty-eight were protests—some of them justified by special circumstances—while the remainder were favorable and most of them full of enthusiastic praise.

Listeners who desire to help the broadcasting stations to which they write should keep in mind the necessity for being definite in their statements and, if the matter is a technical one, critical in their observations. Some listeners are too prone to imagine things. A while ago one of the stations for whose operation I am responsible technically developed hiccoughs a few hours before an exceedingly important program was scheduled to go on. The cause was obscure, and, supported by the other heroes on the technical staff, I started to wrestle with the thingamajigs and doodaddles. With the kind permission of the local Federal official, we put the carrier on during a two-hour blank period and let an orchestra rehearsal go out. Everything—power, radiation, modulation—remained as usual in the past year and a half, and the only irregularity was an intermittent growl down in the bass. While we were sweating and swearing and tearing things apart, a listener called on the telephone. "I wish to report on your test," he announced excitedly. I didn't want any report, but as the most polite and speedy way of getting rid of him I asked what he had found. "Your station sounds just as usual," he declared after some irrelevancies, "but the wave is terribly broad!" Restraining an impulse to reply, "So's your old man!" I thanked our informant and got away, having lost several minutes when I needed them as a squirrel needs acorns during a severe February.

On the other hand, several of our listening customers render us occasional valuable aid with all the precision of observation and expression of trained engineers, although one of them is a physician and others are in similarly detached professions. Out of a spirit of pure helpfulness, they write extensive reports full of valuable technical data. The same thing is true on the program end. Every program manager has a circle of listening friends whose judgment and criticism are important factors in determining the nature of the material he uses. "Applause mail" is necessarily one of the guide-

posts in program work. Letters from people who know definitely what they want and don't want, and why, are always carefully read. It is not always possible to answer them individually; if the volume of mail is great, a system of form answers is the only way to avoid running into prohibitive expense, although even then some of the letters must receive special attention.

The more pretentious the writer, the less the value of his letter, as a general rule. Recently I received a report on signal strength from one well-wisher who printed "Radiotrician" under his name. There was not the slightest sign of an address on the letter, and all it told me was that someone in the United States heard us satisfactorily. And in the letter he asked for an answer, and he is probably riled because he failed to get one!

The listeners have their foibles, just as the broadcasters have theirs. And it is hard to please all the people all the time. In fact, as I have had occasion to argue in this place before, to attempt to do so leads directly to stultification. And some members of the audience will always prove unreasonable. All that is true, but in the last analysis the progress of broadcasting is accelerated by the pressure exerted by unsatisfied patrons. The power level is being raised because people object to getting their music mixed with the electrical racket of the vicinity. The programs are improving because people will no longer listen to feeble stuff, and because they want entertainment as good as that of the best theatres and concerts. Not everybody can keep up with the procession. Well, if some of the stations fall by the wayside, the event is proof, in each case, that there is no place for that station. So let the tomahawks fly, and the devil take the hindmost; the time may yet come when Mr. Hoover will be able to separate stations by so many kilocycles that the "dyne" squeals will be lost in the upper reaches of audibility, and for that and other blessings we shall have to thank, in part, the listener-die-hards.

### A Jazz Lover Lifts His Voice

COMMUNICATION from a defender of jazz harmony, Mr. Bernard Kelly of Pueblo, Colorado:

SIR:

You are about to solve a great problem for me. I am one of "Those things" that like their jazz straight, and in these times when radio broadcasters are simply drenching the nation with the polluted stuff, I can't seem to bag it. I thought that I might be trying to operate my set without aerial and ground, but this does not seem reasonable, as I can get any number of salon orchestras, coloratura sopranos, and players of Bach and Wagner. Perhaps atmospheric conditions here are so educated as to shut out the barbaric jazz and give asylum to the classics which nobody else can find. Need I add that I was desolated until I read your December article.

Apropos of your statement: "If you want Jazz issuing from your loud speaker, there are certain wavelengths in every locality where you can get it at any time." I am enclosing herewith a little blank of my own arrangement, together with a stamped, addressed envelope, whereon you, being a good sport, will inscribe these various stations. I use a Roberts Knock-out set. Let this guide you in your choice, and remember, I'm very choosy about my jazz. I would have been satisfied to get it on the headphones, but your added promise of loud speaker volume greatly pleases me, and in return for this favor, I'll give you a tip. KOA of Denver is one of those stations where they specialize in uplift. They have there some very palatable violinists and pianists, together with an array of songsters who have never heard of Irving Berlin. Moreover, they have just begun to give Spanish lessons. Here indeed is a safe refuge from Jazz. I await your reply most impatiently.

The blank to which Mr. Kelly refers is prepared with, as can be seen, diabolical ingenuity and thoroughness; its general lay-out will appear from the sample which I am magnanimous enough to print above:

WHERE TO GET JAZZ WHEN YOU WANT IT

Compiled by Carl Dreher

HOURS  
Mountain Time

Day 7 P.M. 8 P.M. 9 P.M. 10 P.M. 11 P.M. 12 P.M.  
SUNDAY  
MONDAY

If Mr. Kelly was "desolated" before the appearance of my article "In Defence of Broadcasting" in the December number, by the dearth of jazz on the Colorado steppes, he was in no worse case than I am at this moment. I am not merely desolated, but prostrated, and there is nothing more terrible than to be desolated and prostrated at the same time. In fact, the coincidence of these two acute malaises is so rare and dangerous that I may be able to make some money by exhibiting myself before the annual meeting of the American Medical Association (if they have one), or by travelling with an old-fashioned medicine show (if any still exist). The last time I was so sad was twelve years ago, when my first audion bulb gave up the ghost after two hours of use, leaving me bankrupt and heartbroken. My present grief flows from two sources: first, from hearing Mr. Kelly cry "Jazz! Jazz!" when there is no jazz, and secondly, because I am unable to make good on the sentence which Mr. Kelly has plucked out of my article. It appears that there is a neighborhood where jazz is not always on tap for those who crave its charms. Well, that's certainly too bad. Mr. Kelly might try some suasion on Mr. Talbot, the program man at KOA. If all else fails, he can move to New York, a town which spouts hot jazz as Old Faithful spouts hot water. Above 360 meters one gets it now and then; below 360 meters jazz runs riot. Incidentally, in common with the Hon. Gilbert Seldes, I have no objection to the stuff in limited quantities and

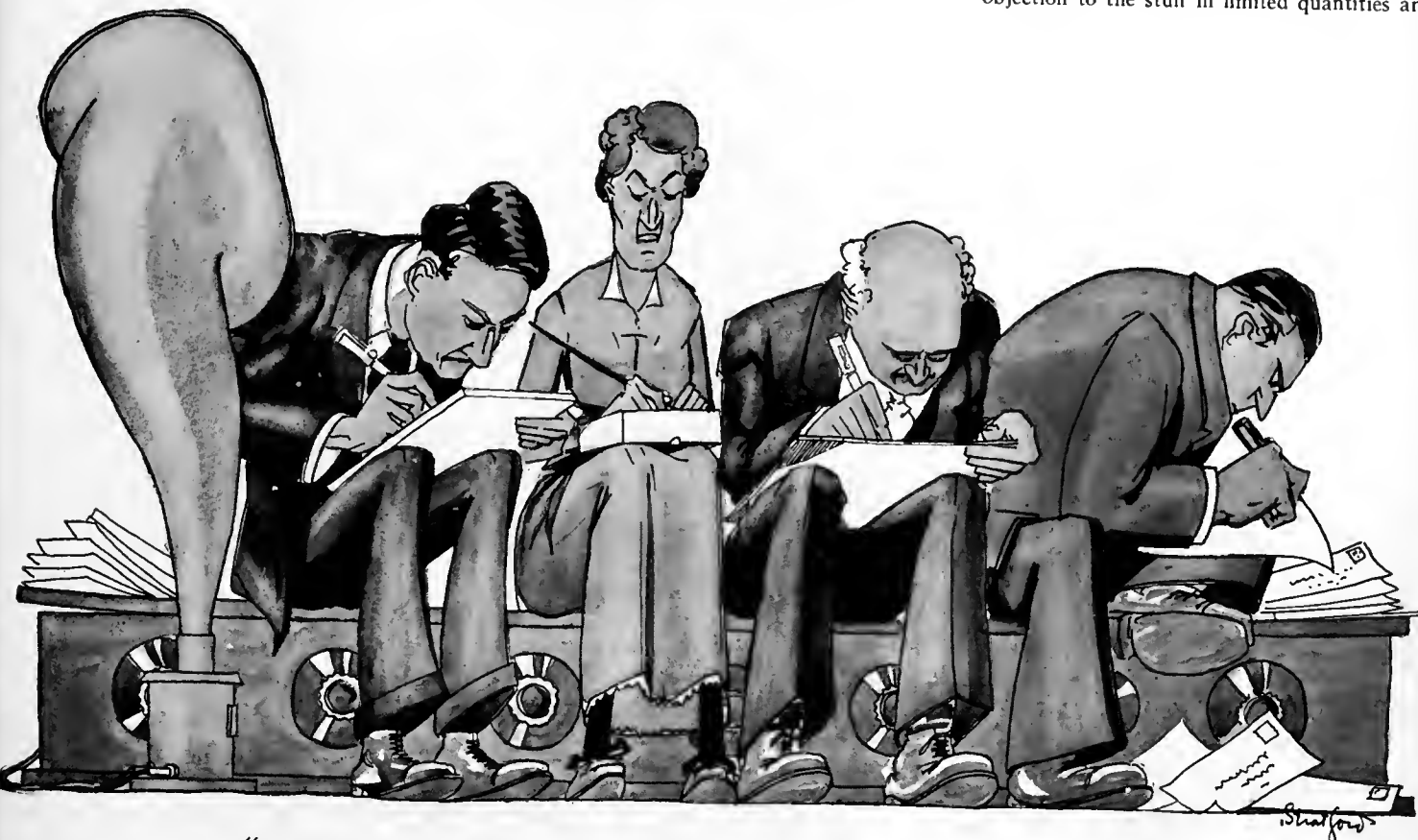

"THEN TWENTY IRATE LISTENERS WRITE A LETTER TO SECRETARY HOOVER."

when it is well done. I would rather listen to a good jazz band than a rotten soloist; there are even times when I'd rather listen to a good jazz band in preference to a good soloist or classical orchestra, depending on my mood. For example, when I write out my income tax check, once a year, I like to listen to jazz; it cheers me up. The only reason I took Mr. Nathan up on this question is that he seemed to think that radio music is practically all jazz, a conclusion with which my battered ears did not agree. And now along comes Mr. Kelly, roasting me by implication, because there isn't enough jazz! I give it up!

### Technical Routine in Broadcasting Stations

#### 3. Monitoring

THE word "monitor" is one of the contributions of wire telephone practice to broadcasting. Its technical meaning is to listen to what is going over a circuit for the purpose of making indicated adjustments. The principal one of these adjustments, in broadcasting, is the regulation of the amplification, or "gain," as the telephone people call it.

Skillful broadcast monitoring is an art in itself. The necessity for it arises through the fact that radio transmitters cannot be built, at the present stage, to accommodate the extreme ratios in volume of many musical performances. The energy emitted by a symphony orchestra, going full blast, with the conductor sweating like a stevedore and all hands sawing, thumping, and blowing to the maximum capacity of their instruments, is in the ratio of about 100,000:1 to a few of the pieces playing *pianissimo*. This does

not faze musicians a bit, but it gives an engineer the willies. The power ratio of machines—the ratio of the maximum power which the machine can handle effectively, to the minimum, is as a rule quite low, probably not more than 10. One cannot build a machine which will have the power of a locomotive, when that is required, and which in the next second can be used to crack nuts efficiently. If it is a good nut cracker, it will not be an adequate locomotive, and if it is a good locomotive it will be lamentably wasteful as a nut cracker. This is from the standpoint of the engineer as a manipulator of energy—raw horsepower. But a broadcast transmitter is not a mere engine. It is a combination of musical instrument and machine. So a compromise becomes necessary. The energy ratio remains large, say of the order 1,000:1, but even so it is only one tenth of one per cent. of the original. The reproduction is not perfectly natural, but it sounds better than it would if the 1,000,000:1 ratio were the basis of operation. In that case the low portions would drop below the noise level, with the result that portions of the performance would be lost altogether. By ironing out the peaks and faint passages to this extent the ultimate quality of reproduction is at its best.

This 1000:1 reduction in ratio is accomplished manually. Of course, in many types of music the actual original ratio is much lower than a million to one, and in that case the reduction should be correspondingly modified, the object of the competent control engineer always being to leave the original alone just as far as the load characteristics and noise level of the broadcasting medium will permit. There are, in general, two types of incompetent control operators. The first is careless; he "lets it ride." Sometimes he lets the level drop so that no one on the outside hears it, and at other times he allows overloading and distortion to mar the performance. The announcements are too high or too low with respect to the music. They should be slightly above the average value of the music, say 60 per cent. amplitude. The second type of undesirable control operation is the over-cautious method, whereby the modulation is ironed out to such a degree that most of the contrast is lost. This fellow constantly pulls down the gain when the music is loud, for fear that it will overload, and brings up the *pianissimo* passages so that the listeners will be sure to hear them. He can't do much to a jazz band, but heaven help the station which lets him loose on a symphony orchestra. A good gain regulator is like a good fighter; he always has something in reserve. He is unlike a fighter in this: he seldom moves fast. Jerky manipulation of the amplification handle is out of order. The movement should be smooth; the only abrupt changes in the music should be those which the composer wrote into it. Of course the whole thing can be gauged better by one who knows the piece being played. He can look ahead and give a more finished performance than the man who has no idea of what is coming next. The gain control should not be moved except when

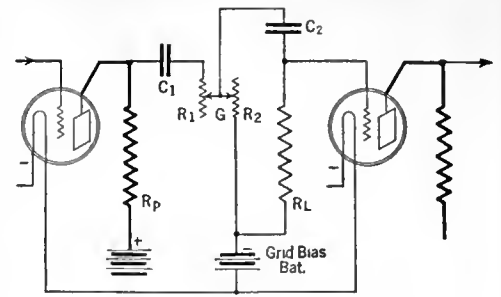

FIG. 1  
A "Gain" control in a field control set

necessary, and then its movement should never be neglected; the competent control operator knows which is when.

On field events, the control should be in the hands of the field technician, he being on the ground and in a better position to judge than the man at the station end of the line. The station engineer sets his gain control once and for all, theoretically, moving it after that only to correct errors on the part of the field man. On studio events the job devolves on the station control operator, necessarily. As a rule, less monitoring is required in the studio, for very large orchestras, organs, choruses, etc., are encountered more in the field.

The usual form of gain control is a potentiometer arrangement carrying only audio fre-

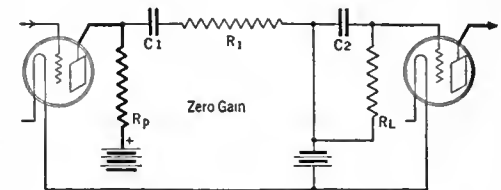
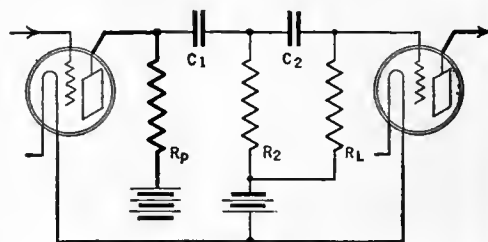

FIG. 2

quency and isolated by means of condensers from any d.c. circuits whose variation would give rise to noise. Fig. 1 shows such an arrangement between stages of a resistance-coupled amplifier.  $R_p$  is the resistance in the plate of the first tube,  $C_1$  a condenser of the order of 0.5 mfd. separating the gain control and following tube from this plate circuit,  $G$  is the gain control, which is so arranged that as one resistance  $R_1$  is cut in, the other resistance,  $R_2$ , is correspondingly reduced,  $C_2$  is the second isolating condenser, of the same magnitude as  $C_1$ ,  $RL$  is the grid leak of the following tube. Fig. 2 illustrates how, with the contact in one extreme position,  $C_2$  has one side short-circuited to the filament of the second tube, while the resistance  $R_1$  is in series between the tubes, practically blocking the transfer of audio voltages. In Fig. 3, the reverse condition obtains,  $R_1$  being all out, while the total drop of  $R_2$  is available to pass on audio fluctuations to the second triode. This gain control is noiseless, unless the sliding contacts are so bad that they open momentarily,



Maximum Gain  
FIG. 3



HE CRIES "JAZZ, JAZZ," WHEN THERE IS NO JAZZ

breaking the connection between the tubes between which the gain control functions.

The crude gain control which is sometimes seen in small stations—a means of cutting down filament voltage on one of the audio amplifiers, is bad because as the emission of the tube drops the impedance rises, resulting in the loss of low frequencies in most cases, as well as other anomalies.

### Memoirs of a Radio Engineer

#### X

IN THE January issue it was related how the Federal legislation of 1912 started to bring order out of chaos in the radio world. The job was not a small one, and now, thirteen years later, it is not yet completed. For as fast as one patch of chaos was ironed out in one place, another, such as broadcasting, bobbed up somewhere else, to keep the authorities busy. That the law was provided with teeth was demonstrated very shortly. A young man who, after the passage of the act providing for station and operator's licenses, had continued to transmit without either, on a wavelength that happened to suit him, was haled to court and fined. This was in 1913, and the incident received considerable publicity. The law had gone into effect December 23, 1912, and by that date about five hundred of the twelve hundred amateurs in New York City had applied for their papers. Those who continued to operate were warned by W. D. Terrell, now Chief Supervisor of Radio, with headquarters in Washington, but then in charge of the New York district. "These amateurs," said Mr. Terrell, "who make it a practice to interfere with business communication, are nearly all known to us. There may be a very few whose whereabouts we have not yet found out, but in a short time, thanks to the efforts of commercial stations and of the vast majority of amateurs, who realize that the delinquencies of these few may call for laws still more strict,

we will run them all down." And indeed, after a half year or so, the only unlicensed amateurs left were little fellows with spark coils of limited range; practically all the big fellows had submitted.

I had no transmitting station worth the name, but by this time I was fairly adept at copying and was filling my log book with such entries as the following:

- Sept. 10, 1912. 2.27P. Ward liner *Havana*, WH, talking to NY. Distance, 251 miles.
- Jan. 11, 1913. 8.00P. MAA, White Star *Carmania*, working MSE.
- Jan. 20, 1913. 2.23P. SS *Moltke*, DDM, working MSE. Good sig.
- Mar. 1, 1913. 5.15P. KKK, SS *El Occidente*, calling MSE. Comes in well with low tone. Wanted to know if MSE knew where SS *Comus* was.

MSE was the Seagate land station, later WSE, a famous transmitter in its day. It had a 3-kw transmitter with rotary gap.

My log book also contains numerous messages copied from ships and the few land stations around town. Besides WSE, the principal transmitters in the New York district at this time were FNK, the Bush Terminal station of the National Electric Signalling Co., and TWR, operated by the Atlantic Communication Company at 111 Broadway. The latter two had beautiful notes around 1000 cycles, which they maintained with remarkable purity of tone for weeks at a time. Their flute-like whistles enraptured all the amateurs, half of whom would cheerfully have killed a man for a 500-cycle alternator and a quenched gap.

"Wireless telephony" was not unknown, but it was as yet no more than a curiosity. The principal hope of its proponents was that it might supplant wireless telegraphy; its application in broadcasting apparently occurred to no one, as yet. The following report in the *New York Times* shows how radio telephony was regarded toward the end of 1912:

## VOICES HEARD BY WIRELESS

### Marconi Operator Picks Up Conversation 150 Miles Away

SAN FRANCISCO, Dec. 18.—A demonstration that wireless methods may be used for transmission of the human voice was made on the recent trip of the Pacific Mail liner *San Jose*, which reached here to-day from Panama. Last Monday, while off the Lower California coast, C. H. Kessler, the ship's Marconi operator, distinctly heard conversation while he was taking a wireless message. The conversation was a test of wireless telephones between Catalina Island and the mainland of California, and was carried on 150 miles from Kessler.

At noon, when R. H. Shimek relieved Kessler, he also heard scraps of conversation, as well as music from a phonograph. As several passengers were around the wireless room he gave them individual receivers, and they heard ragtime music distinctly, and even danced around the deck to the tunes. The Captain was called in and heard the music.

This experience was said to be the first of the kind ever recorded, and it suggests that the wireless at sea may yet be handled like the telephone, which would be a great economy in time of transmission, especially in the case of vessels in port.

Antique stuff! Even the words—"wireless," "ragtime," are out of date. And the speculation in the last paragraph was on the wrong track. By far the best way to communicate with vessels in port is by the simple expedient of hauling a telephone cable aboard and hooking up the ship to the nearest exchange. The big ocean liners all have telephone switchboards, and when



“ . . . THE ENERGY EMITTED BY AN ORCHESTRA GOING FULL BLAST. . . . ”

they are at their piers you call up the various extensions just as you call up the local delicatessen dealer or the town dog-catcher. And when they are at sea, the radio telegraph provides a faster and more reliable service than telephony can give. The code cuts through static and interference where telephony would only yield a jumble. Even now only a few ships carry radio telephone transmitters, and they are considered a luxury, although presumably the time will come when the great liners will carry extremely powerful radio telephone sets providing a ship-to-shore service linked up with the land telephone. But the wireless phone did not have to await this development before it could come into its kingdom. Broadcasting supplied that.

### Broad Waves and Sharp

ONCE an error has taken firm root the only thing to do is to wait a few centuries until it is forgotten, for you will certainly not get rid of it in any quicker way. Thus, probably a majority of the population still believe that blondes are treacherous, that no one with brown eyes can ever become a great man, that touching a toad will cause warts, and that Aaron Burr was a villain while Alexander Hamilton was an angel. There is no law against believing what one pleases, even though it is wrong. This is likewise true of the almost universal belief among radio listeners and newspaper critics that in some mysterious way the engineers of a broadcast station can sharpen its wave, as if it were a pencil which can be whittled down with a jack knife. Everybody believes it, although it isn't so. It is true of a spark station emitting a decadent wave train, and that is no doubt the origin of this radio superstition. But given a broadcasting station of P meter-amperes modulating a continuous wave of a certain radio frequency Y, modulated at audio frequency X with per cent. modulation Z, the only factors influencing the broadness of tuning in reception are (1) The signal strength at the point in question, and (2) The kilocycles admittance of the receiving set at the said frequency Y. In other words, when people talk of a broadcasting station as having a "broad" or "sharp" wave in the abstract they are emitting nonsense. It becomes sense only when a particular receiving location with known signal strength from the station in question, and the tuning characteristics of the receiving set, are definitely specified. When a listener declares that a certain broadcasting station has a "broad" wave, it usually means that he gets a very strong signal from that station, or that he has a badly designed receiving set, or both. If he says that the wave is "sharp" the conclusion is that the signal is relatively weak, or that the receiver tunes sharply, or both. Assuming the power of the station as fixed, it has no control over either condition.

### The Lingo of Radio

*Onomatopoeia*

THIS disagreeable looking Greek word is applied to those terms which through their sound imitate the thing described. There are a few such words in radio, most of them not of radio origin, however. "Buzzer," for example, and "howling," "squealing," for uncontrolled

audio frequency oscillation, as of an amplifier. The older telephone term for this phenomenon, "singing," has not broken into radio to any extent.

The only original radio names which exhibit the tendency toward sound imitation in word formation appear to be the words describing certain kinds of strays: "Clicks," "crashes," and "grinders." "Clicks" are the short sharp impulses, "crashes" are somewhat longer and more bothersome; "grinders" are still longer and may consist of a succession of shorter impulses.

#### Imported Words: Foreign Influences.

Except from the English, American radio is indebted very little to foreign languages for its radio terminology. The only instance I can recall offhand of a word borrowed outright is the German "litzendraht" for stranded high frequency conductor, and this has been modified into "litz."

It is interesting, however, to note how widely British and American radio terminology differ. The divergence, of course, is by no means confined to radio. Again, a Britisher talks of "ordinary" and "preference" stock, where an American says "common" and "preferred." The following is a comparison of a few British and American radio terms:

BRITISH	AMERICAN
Anode, plate	Plate
Ebonite	Hard rubber
Gear	Apparatus
Components	Parts
Maker	Manufacturer
Factor	Jobber
Earth	Ground
Basket coils	Spiderweb coils
Pile winding	Bank winding
Valve	Bulb, tube
Reaction	Regeneration
X's, atmospherics	Static
Note magnifier	Audio amplifier
Accumulator	Storage battery
Frame aerial	Loop
Jigger	Oscillation transformer spiral helix
Anode (of a tube)	Plate
Low frequency (l.f.)	Audiofrequency (a.f.)

High frequency (h.f.)	Radio frequency (r.f.)
Terminal	Binding post
Telegraphist	Operator

The curious term "listen-in," incidentally, appears to be of English origin. Why the "in" was added is as much of a mystery as the appearance of the same preposition in the British slang phrase, "do him in"—"kill him." Whatever its origin, it has led to some horrible compounds, like "listeners-in," which is about as far as one could go if one sat down to invent the most awkward phrase possible.

Why do we speak of an air-core transformer? The case is really one of the absence of a core, and we might better call it a "coreless transformer" or an "air transformer." Of course air is something—witness the trouble we take to get it out of our electron tubes, but is it solid enough for a core? However, we all talk of it in that way.

Why "variometer" to denote a continuously variable inductance? The instrument does not measure anything, so the "meter" part of the name is out of place, and the "vario" is too vague to mean anything. In a less aggravated form, "potentiometer" has the same or similar faults.

The only thing that can be said in favor of the terms "A," "B," and "C," batteries, for plate filament, and grid bias, respectively, is that they are brief. Such arbitrary designations are very puzzling to beginners. These terms, incidentally, date back to the invention of the three-electrode tube.

Of late years, some effort has been made to achieve uniformity in the use of suffixes in speaking of the common electrical properties. On this basis it is not correct to speak of "resistance" coupling in an amplifier; one should say "resistive" coupling. An "inductor" is the physical object or coil possessing the property of "inductance"; its effect is "inductive." Likewise "resistor," "resistance," and "resistive"; "capacity," "capacitance," and "capacitive." However, no one will be arrested for using the wrong suffix.

#### Proper Names

THE Alexanderson alternator, the Poulsen arc, the Heaviside layer, are instances where the name of a man of original ideas has become attached to a machine or theory. The common electrical units, also commemorate the names of great scientists, as the farad (Michael Faraday), the ampere (after André Marie Ampère), the volt from (Count Alessandro Volta), and the henry (Joseph Henry—an American physicist, incidentally). Then there is poor Pierre Vernier, who died in 1637 after inventing an attachment for indicating accurately parts of divisions in linear measurements, and never conceived of a radio set—and his name is applied to the fine adjustment of variable condensers three centuries later!

Radio terms derived from the various older engineering arts are too numerous to mention. Such words as "eddy currents," "secondary," "primary," etc., are of old standing in electrical science. The various prefixes which denote magnitude, such as "meg" (one million); "kilo" (one thousand); "milli" (one-thousandth); "micro" (one millionth); and their combinations, are all in general scientific use and not peculiar to radio.



"A YOUNG MAN WAS HALED TO COURT"



# Standards for the Home Laboratory

*How the Home Experimenter Can Build and Use the Necessary Standards of Inductance, Capacity, and Resistance—Essential Tools for All Kinds of Experiments—More Suggestion for the Ambitious Home Experimenter*

By KEITH HENNEY

*Director, Radio Broadcast Laboratory*

THESE are two stages in the life of any experimenter whether he be inclined toward chemical, mechanical, or electrical pursuits. The first stage may be represented by the desire to do something of an experimental nature, it matters little what, as long as something happens. The second may be marked by the experimenter's desire to know what has happened, if anything, and how much of it has happened. Any one can hook a condenser across the antenna and note what happens. Any one can attach a coil across that condenser and have a wave trap. But after a few preliminary bouts with a tricky device of this nature, the experimenter will probably plot a curve of the thing, showing what happens to certain frequencies when the condenser is varied.

This business of wanting to know what happens, and how much, when the condenser is tuned, signalizes the entrance of the radio experimenter into the second stage of his career. Lord Kelvin, one of the world's greatest experimental and mathematical scientists, is credited with saying that any research enters upon a scientific basis when actual figures are put down on paper, when the experimenter knows how much, and when, and begins to get some idea of "why."

Just as building radio receiving sets palls on most any one after the dozenth is completed, so will endless and aimless experimenting get to be stale sport unless there is something to look forward to.

The staff of RADIO BROADCAST Laboratory has prepared a number of experiments for those who are interested in the more serious side of

radio research, and the essential apparatus will be described from time to time. The first article of this series, in the September RADIO BROADCAST, described a simple vacuum tube oscillator for the home experimenter that in the Laboratory has proved to be of endless service. It consists of a radio-frequency oscillator, a miniature broadcast station in fact, which is modulated with an audible tone. The uses of this oscillator were described in the December magazine. The

capacity, and resistance, and for practically all of his work he uses these quantities in varying proportions and in various relations to each other. He winds a coil and finds that it will tune to a certain frequency band with a .0005-mfd. condenser. He may feel that tuning is broad. He knows then that there is resistance in the coil, too much resistance perhaps. But he wants to know how much, how to reduce it, and what is the practical limit of reducing resistance.

In other words, he wants to know "how much?"

To do exact or even approximate work, the research engineer and the home experimenter alike must know to a certain degree of precision the constants of the apparatus with which he works. To know that one's apparatus is correct to within a certain per cent. is to know that one's results will be valuable to that extent. Accurately designed equipment, carefully calibrated, inspires a degree of confidence in the worker that will be one of his best assets.

In any well equipped Laboratory, the question "how much?" is answered in one of several ways. The simplest method and the one most often employed is a comparison of the apparatus under

test with some high grade standard. For instance, one builds a coil. He wishes to know its inductance and perhaps its resistance. By a complicated series of experiments he may arrive at both of these values, but by a simple comparison with a coil already measured he may arrive at the answer in a short time.

Among the first acquisitions to a home laboratory, then, are standards of inductance, capacity, and resistance with which all unknown coils, condensers, and resistances may be compared.

---

MORE than one satiated home constructor has written us that this series of articles by Mr. Henney, the director of our Laboratory, has caused them to renew their subscription to RADIO BROADCAST and to take a new interest in the technical side of radio. Dust that has collected on soldering iron and pliers is shaken off, and unused parts in the miscellaneous pile of odds and ends owned by every constructor worthy of the name are assuming a new value. There are many among the amateur radio folk who have the feeling that if they could just learn a bit more about what could be called the laboratory fundamentals of radio, they would be able to make considerable progress in the art, and perhaps even make a discovery of some importance. We believe that these articles, of which this is the third, will be of great value to these inquisitive souls. Those two valuable Government radio books, Bulletin No. 74 of the Bureau of Standards, and Principles Underlying Radio Communication, published by the Army Signal Corps are used as bases in the present article. Every radio enthusiast who really wants to learn more about the art should own these volumes, which can be had from the Government Printing Office.—THE EDITOR.

---

present article will deal more with the uses of this device and mention a few lines of experiment along which the home constructor should work.

WHAT ARE THE ELEMENTS OF RADIO?

THE apparatus used in radio consists largely of two simple elements, inductance and capacity, that is, coils and condensers. Each of these components of oscillating circuits has resistance, so the experimenter has to deal with three important electrical quantities, inductance,

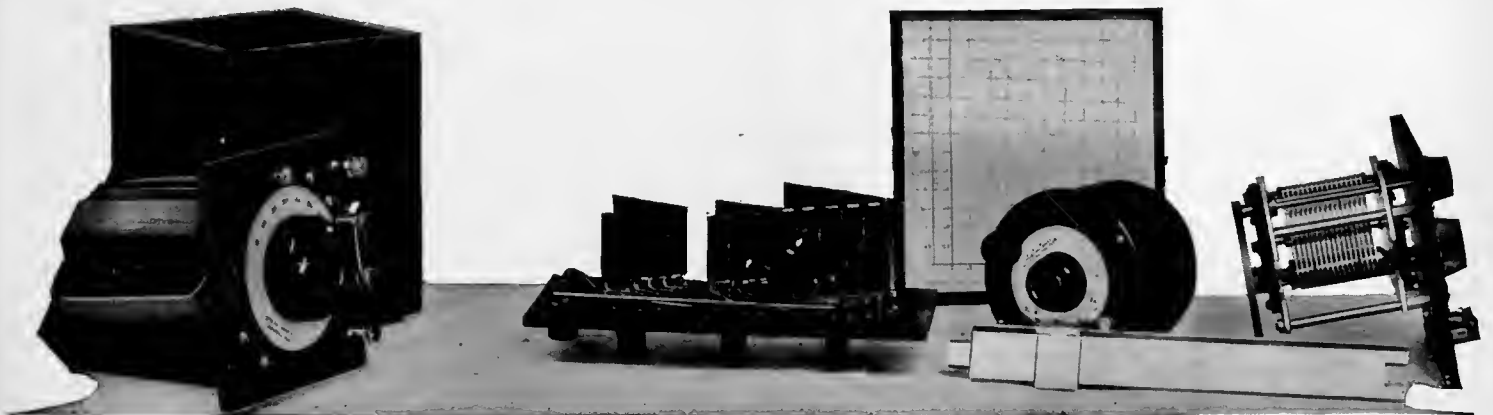

RADIO BROADCAST Photograph

FIG. 1

Some of RADIO BROADCAST Laboratory's standard apparatus. Note the peculiar construction of the "inner works" of the resistance box. The other apparatus is a standard variable condenser and a variometer which is used as a standard of inductance. An idea of the size of the equipment may be judged from the ever-useful slide rule which is just 10 inches long

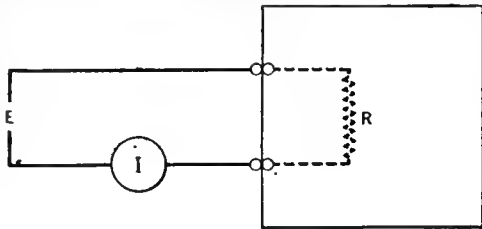

Power = (I)<sup>2</sup> × R

FIG. 2

This represents a source of direct current energy feeding a load which is in the box. If the ammeter is not accurate, the amount of power used cannot be correctly computed

These standards must be carefully made and accurately measured. Fortunately, the construction of a coil is sufficiently simple that anyone can do it, and thanks to the work of the Bureau of Standards physicists, the home worker can calculate its inductance with sufficient accuracy for all ordinary work. Fortunately, too, he may construct a standard of capacity, or at small outlay he may purchase a variable condenser equipped with a dial calibrated in micro-microfarads, such as the General Radio No. 247.

The importance of knowing the accuracy of one's equipment may be illustrated by the following experiment. Fig. 2 represents a source of direct current feeding a certain "load" which is in the box. We desire to know how much power in watts it required. Knowing the resistance of the box and having an ammeter in the circuit, it is a simple matter to compute the power for

power = (current)<sup>2</sup> × resistance

where power will be in watts provided the current is in amperes and the resistance is in ohms. If the resistance is one ohm and our ammeter says that ten amperes are flowing, we get from our formula (10)<sup>2</sup> × 1 = 100 watts. But if our ammeter reads ten per cent. too low, in other words it is only 90 per cent. correct, 11 amperes will actually be flowing and the power will be 121 watts, an error of twenty one per cent.

Or suppose that we want to design an inductance that will tune to 1000 kilocycles (300 meters) with a condenser of .00025 mfd. capacity. At this frequency, the product of the capacity in microfarads and the inductance in microhenries is .025331, so that the inductance value must be 101.32 microhenries. If we design such a coil and our measurements show that it has this value when it is actually ten per cent. greater, that is, 111.45 microhenries, the frequency will be about 950 kilocycles (315 meters). These values come from the relation between frequency, inductance, and capacity.

$$F = \frac{1}{1.884} \sqrt{LC}$$

Such errors are discouraging to any worker, and to one who wishes to make accurate experiments or apparatus, they are hopeless.

Examples of some of RADIO BROADCAST's standards of inductance, capacity, and resistance are shown in Fig. 1. They are made by the General Radio Company. Similar apparatus may be obtained from Leeds and Northrup, the Cambridge Instrument Company, and others. The list numbers and prices for the General Radio Equipment are given below:

Resistance Box, Type 102-K	.1-, 1-, 10-, 100-ohm units	\$47.00
Capacity	Type 239-E .001 mfd.	19.00
	Type 247-E .0005 mfd.	5.50
Inductance	Type 107-G 100 to 6000 microhenries	24.00

A standard fixed capacity is a good addition to any laboratory and may be constructed of metal plates with air dielectric. Neglecting minor corrections, the capacity of such a condenser may be calculated by the following formulae

$$Cmmf = \frac{.0885S}{T} \text{ Where } S \text{ is the area of one plate in sq. cms. Where } T \text{ is the distance apart of the plates in cm.}$$

$$Cmmf = \frac{.225S}{T} \text{ Where } S \text{ is as above in square-inches Where } T \text{ is as above in inches}$$

If some other insulator than air separates the plates, such as mica, or glass, the formula will not hold, and the home constructor is not advised to stray from the use of air in his standard condenser. It has the advantage that it is of constant "dielectric" value. Its use makes it possible to calculate the capacity fairly accurately, and like all apparatus supplied by nature, it is free. As an example, two square plates 10 cm. on a side, separated by one mm. of dry air will have a capacity of 88.5 mmf. as shown below

$$Cmmf = \frac{.0885 \times 10 \times 10}{.1}$$

$$Cmmf = 88.5$$

A good variable condenser may be any of the commercial types. The General Radio Type 247 is specially valuable if provided with a calibrated dial. The standard should have a capacity of about .0005 to .001 microfarad, should not be equipped with a stop so that the plates may be rotated through a full revolution without bringing up against a metal pillar with a thud sufficient to move the plates on the shaft. This would invariably spoil the calibration of the instrument. It should be of the old fashioned straight line capacity variety since the curve of such a condenser will be a straight line as is shown in Fig. 3 which is the calibration of the Laboratory's standard.

The ordinary small bypass condensers are not at all suited for laboratory standards. They have been known to depart as much as 50 per cent. from their rated capacity and are not independent of external conditions such as moisture and temperature. Sangamo fixed condensers, however, have been found to be within 10 per cent. of their rated capacity and are usually within 5 per cent. It is probable that manufacturers of similar condensers will furnish ones of measured capacities at slightly increased cost. Variables with calibration curves may also be

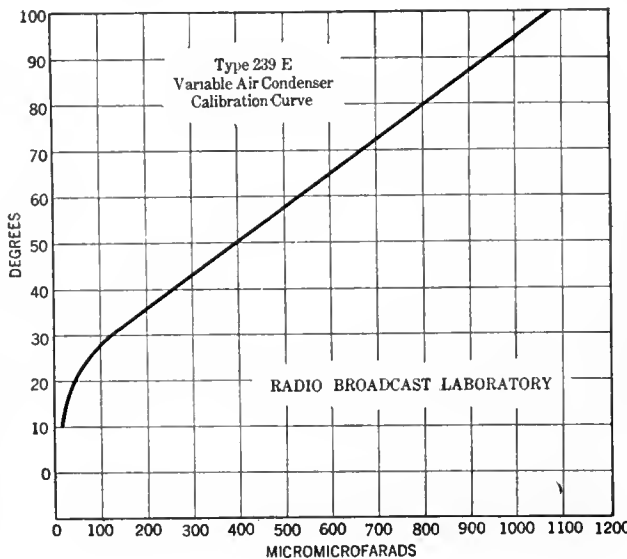
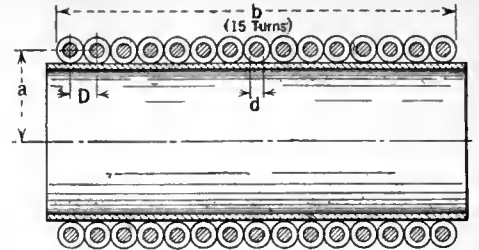

FIG. 3

A calibration curve of the standard condenser shown in Fig. 1. It is of the "straight line capacity" type and is an excellent standard



DATA	N = 15	b = NO = 15 × 1.1 = 16.5
	d = 4 cm	2a = diam. = 24.4
	0 = 1.1 cm	b = length = 16.5 = 1.48
	a = diam. of tubing + d = 12.2	K for 1.48 = 0.598
		L = 48 microhenries

FIG. 4

Essential dimensions for a coil whose inductance will be 48 microhenries. The dimensions are those that are to be fitted into the formula given in the text

obtained from well-known manufacturers, or they may be sent to RADIO BROADCAST's Laboratory where they will be calibrated at a nominal cost.

INDUCTANCE STANDARDS MADE AT HOME

THE construction of an inductance standard should present no difficulties to the experienced home constructor. He should procure a coil form, bakelite, hard rubber, glass, cardboard soaked in paraffine, or some other insulating material, wind it full of No. 18 d.c.c. wire, attach the ends of the wire to small binding posts at the ends of the tubing, and calculate the resultant inductance. Fig. 4 shows the essential dimensions of an inductance in centimeters and gives the values to fit into the inductance formula below, which may be found in the Bureau of Standards Circular No. 74, and the Signal Corps Book, Principles Underlying Radio Communication

$$L \text{ in microhenries} = \frac{.0395A^2 N^2 K}{C}$$

The method of applying the data to the formula is shown below. The constants are taken from Fig. 4.

$$L = \frac{.0395 \times (12.2)^2 \times (15)^2 \times .598}{16.5} = 48 \text{ microhenries}$$

These values may be found on Page 386 of the Signal Corps Book already mentioned and a drawing of such a coil is shown there too. As another example a single layer coil on a five-inch form 11 inches long and having a total of 150 turns will have an inductance of a little over one millihenry. This is too large for ordinary radio measurements over the broadcast band of frequencies, since the coils ordinarily used have an inductance of from .1 to .5 millihenries, or 100 to 500 microhenries.

The factor K in the above formula varies as shown below. The inductance may be more accurately calculated if the coil is somewhat longer than its diameter. Attention is also called to the coil inductance chart published in RADIO BROADCAST, May, 1925, Page 46.

DIAMETER	K	DIAMETER	K	DIAMETER	K
LENGTH		LENGTH		LENGTH	
.10	.959	1.25	.638	3.00	.429
.25	.902	1.50	.595	3.50	.394
.50	.818	1.75	.558	4.00	.365
.80	.735	2.00	.526	5.00	.320
1.00	.688	2.50	.472	6.00	.285
				8.00	.237

After the coil is wound it should be given a coat of collodion, a performance that will cause many eyebrows to lift. Collodion, so it is said, increases both capacity and resistance of a coil. This is true, but for a standard of inductance one must have a coil that once calibrated will not

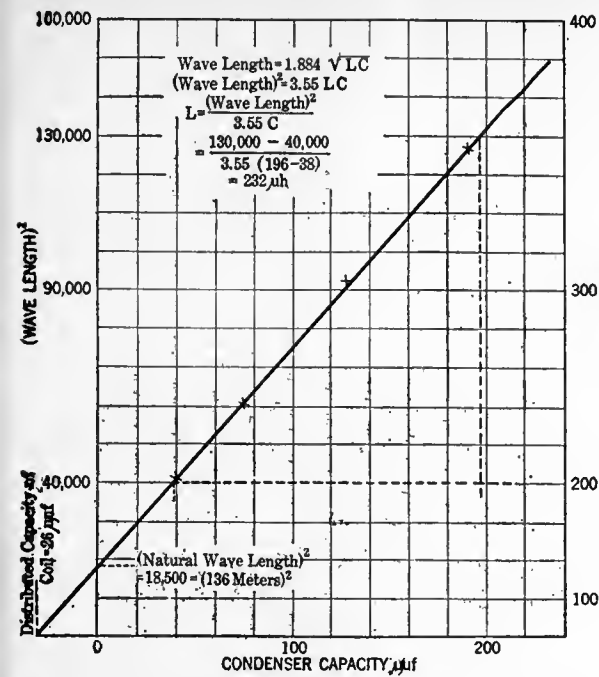

FIG. 5

An interesting experiment that any one with a calibrated condenser and a source of radio frequency voltage—an oscillator, or signals from broadcasting stations—can perform. This curve was made from data on a rather poor coil, poor in that its distributed capacity is higher than is desirable

vary. A coil whose wire is firmly held together and to the form and made moisture proof will have fairly fixed constants. The fact that its resistance and capacity are somewhat greater than desirable for a tuning coil need not bother us at all since it is only to be used as a means of comparing inductances.

INDUCTANCE-CAPACITY EXPERIMENTS

HERE is an interesting experiment that any one can perform provided he has a calibrated condenser, a coil, a source of oscillations variable over a certain range of frequencies, and a simple receiver. The source of oscillations may be broadcasting stations whose frequencies are known, or the radio part of the modulated oscillator; the receiver can be anything that oscillates, from a single-circuit blooper to the detector circuit of a Roberts, a Browning-Drake, or any similar receiver.

The coil is shunted by the condenser and tuned to various frequencies. To tell when it is tuned, the inductance should be brought near the tuning coil of the receiver. When the coil-condenser

unit is accurately tuned to the incoming frequency to which the receiver is already in resonance, a sharp click will be heard in the telephones indicating that enough energy has been subtracted from the oscillating detector by the tuned circuit actually to stop oscillations. A different frequency is then chosen and a new point determined. After several of these points have been found, a curve is made, plotting the wavelength squared against the shunt capacity as shown in Fig. 5. This should result in a straight line which is really a picture of the formula,

$$(\text{wavelength})^2 = (L \times C) \times 3.55$$

The chart in Fig. 5 shows the method of ascertaining the inductance of the coil, its natural wavelength, and its distributed capacity. This experiment does not give accurate results, but it will give the home constructor several hours of enjoyment. He will find that some coils will have large distributed capacity—which is bad—and that when this capacity is large that the coil will not tune to the higher frequencies (lower wavelengths). He will be able to compare the value of inductance determined in this manner with that calculated from the formula already given. He will begin to see how coils and condensers perform when they are in a receiver.

The data for Fig. 5 is as follows:

Cmmf	FREQUENCY	WAVELENGTH	(WAVELENGTH) <sup>2</sup>
75	1,224 KG.	245	60,000
125	985	305	93,000
190	845	355	126,000
250	736	407	166,000
325	674	452	205,000
380	605	495	245,000

L from curve = 232 mh.  
" as measured on bridge = 210 mh.

Now that descriptions of both capacity and inductance standards have been given, and it is assumed that the home constructor has added such apparatus to his laboratory, it is necessary to have some method by which they can be used to measure other unknown coils and condensers.

The simplest method is by the use of a slide wire bridge as shown in Fig. 6. It consists of a straight piece of wire of uniform thickness, preferably of one of the high resistance alloys such as manganin, advance, nichrome, or similar wires and about two feet of No. 24 will make a very good bridge.

The exact resistance is immaterial, although it should be as high as is consistent with mechanical strength. Too fine a wire will not last, and too large a wire will not have sufficient resistance. No. 24 seems to be a fair compromise. A scale divided in some convenient manner is fixed below the wire so that the ratio between A and B may be easily read.

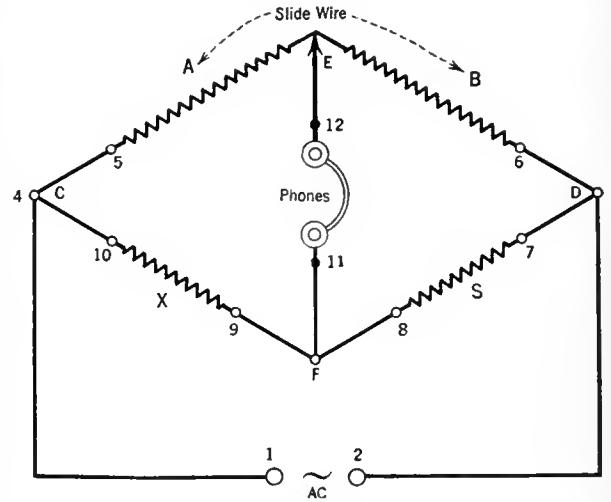

FIG. 7

The principle of the slide wire bridge. When no sound is heard in the telephones, there is a simple ratio which exists between the various "arms" of the bridge so that the unknown may be calculated

Binding posts are provided so that telephones, the a. c. voltage, and the standard and unknown inductances, or other apparatus, may be attached. Extra binding posts should be provided so that fixed known resistances may be added to the two arms of the bridge to increase its usefulness as indicated later.

The principle of the bridge is shown in Fig. 7. Here are four arms, A, B, X, and S. These arms may be resistances, capacities, or inductances, or they may be combinations of these three variable quantities. Usually, and as in this case, A and B are pure resistances with a variable tap X represents the unknown being measured, S is the standard.

An alternating voltage is placed across the bridge as shown in Fig. 7 and a pair of telephones

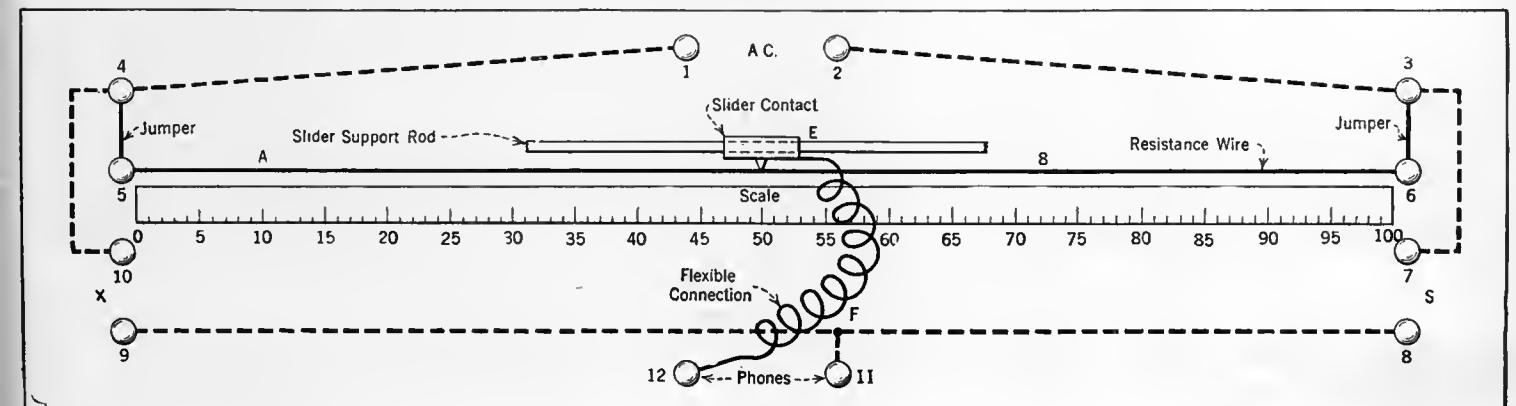

FIG. 6

A simple slide wire bridge by means of which comparisons may be made between unknown capacities, resistances or inductances and laboratory standards. In a home or commercial laboratory such a device is extremely useful

are used to indicate a balance. The a. c. voltage may be supplied by a buzzer, or better by a vacuum tube oscillator, such as the audio part of the modulated oscillator already mentioned.

In practice, the unknown is placed at X, the standard at S, and the variable slider moved along the slide wire until the sound in the phones is balanced out. At this point the voltages at the points C and D are equal (no voltage difference across the receivers) and the following relations hold:

$$\begin{aligned} (1) I_A &= I_X \\ (2) I_B &= I_S \\ (3) \text{Divide (1) by (2)} \\ \frac{A}{B} &= \frac{X}{S} \end{aligned}$$

The result is that the same ratio between X and S exists that holds for A and B, and this latter may be easily read from the graduated scale below the slider. For resistance and inductance it means that X may be found by substituting in the above equation and for capacity the inverse relation is the true one. That is, for capacity:

$$\frac{A}{B} = \frac{S}{X}$$

For example let us suppose that we have placed our standard inductance at S and an unknown at X and that when no sound is heard in the phones, or a minimum sound, the slider lies at 40. Then A=40, B=60 and

$$\frac{40}{60} = \frac{X}{500} = 334 \text{ microhenries}$$

provided the standard is known to be 500 microhenries. If we were measuring capacity and the standard S was equal to .001 when the slider read 40 and 60 for the arms A and B the ratio would be

$$\frac{40}{60} = \frac{.001}{X} = .0015 \text{ microfarads}$$

#### MAKING RESISTANCE STANDARDS

THE construction of high frequency resistance standards presents a more difficult problem to the average constructor. Such resistances should have neither capacity nor inductance, and that's the trouble. They should also be independent of the current passing through them; in other words their resistance should not vary as they warm up.

For high frequencies there is no resistance unit that will be better than a single straight wire as short as possible. It has negligible inductance at ordinary frequencies. Until the construction of such units are described in RADIO BROADCAST the reader is referred to the Bureau of Standards *Circular No. 74*, sixty cents, or to an article by John M. Clayton in the October, 1925, *QST*.

Mr. Clayton uses maganin wire, B & S gauge No. 38 to 44, and for resistances from .1 to 30 ohms, the wire will be one quarter to 2½ inches long. The ends are soldered, with a minimum of solder, to heavy copper wires and the resistance part of the unit sealed into small glass tubing so that it will be protected. After these units are constructed, they must be measured on some sort of bridge and that is where the average home constructor will have the greatest

difficulty—for he must have a standard resistance to begin with.

The process of making such a set of resistance units will be described soon, and at the same time the proper procedure to have them measured will be outlined.

With the modulated oscillator, inductance and capacity standards, and the simple slide wire bridge the home experimenter can do many interesting things. He may investigate the distributed capacity of coils, he may neutralize his receiver which may be built from coils whose constants are known and whose tuning range may be calculated in advance. He may measure the inductance and capacity of home made or manufactured material. When he buys a bypass condenser he may actually find out what its capacity is, and many will be his surprises.

Throughout his investigations, the home experimenter should keep a careful notebook. Everything should be put down that seems to have any significance at all. The worker can never tell when his data may be useful in the future. It may save him considerable time to be able to turn to page so-and-so in his notebook and find an exact calibration of this condenser, or variable inductance, or the frequencies a certain combination of coil and condenser will tune, or the capacities of certain fixed condensers that are about the laboratory. And if unexplainable happenings take place, let the experimenter put down as nearly as possible what he believes is taking place, circuit diagrams, the constants of all apparatus—perhaps at some future time such data may be useful in patent cases. One can never tell in these busy days of radio invention.

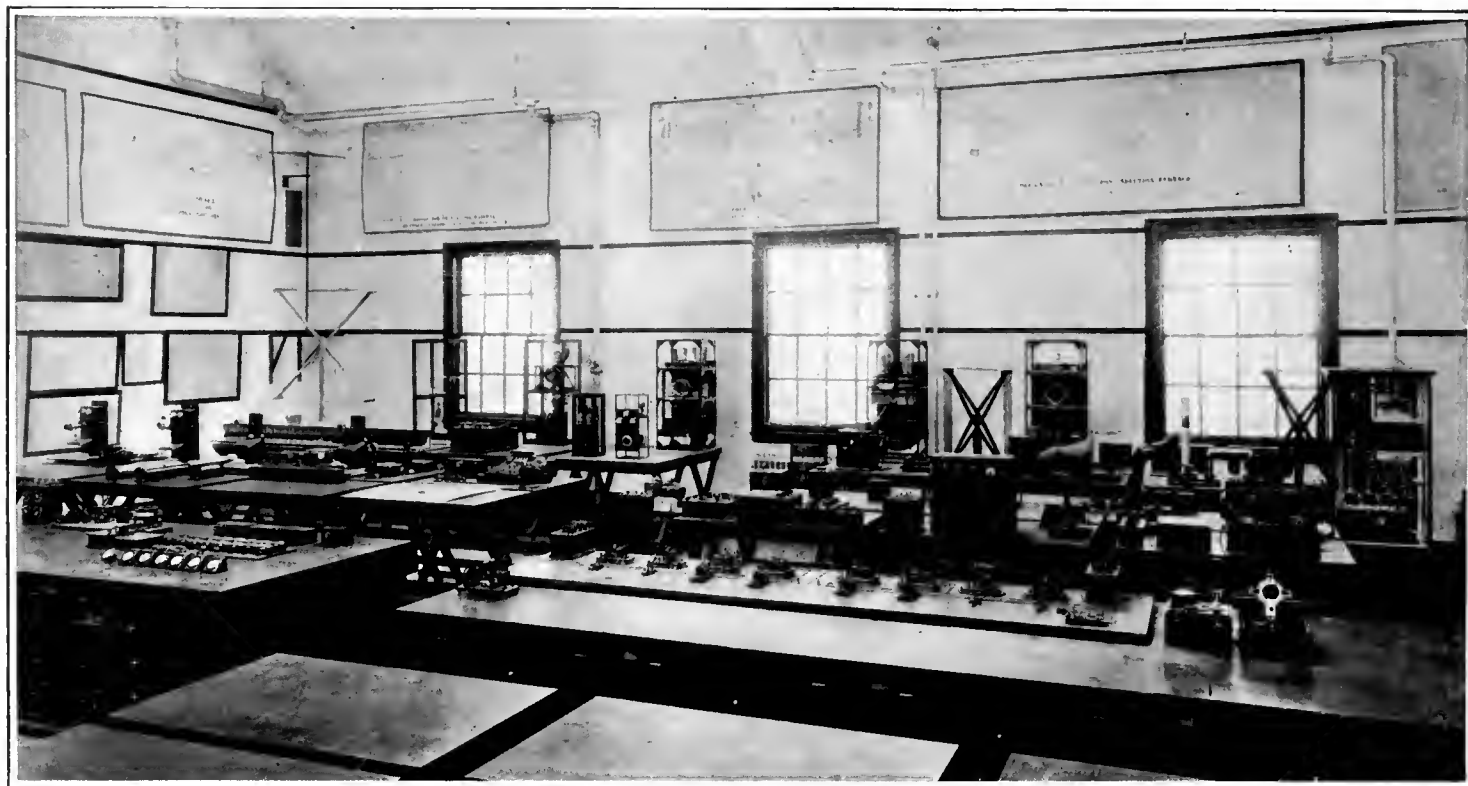

A WELL EQUIPPED RADIO LABORATORY

A view in the electrical engineering laboratory of Rennselaer Polytechnic Institute at Troy, New York. The home experimenter can never hope to attain an expensively equipped laboratory with all the various instruments found in such laboratories as Marcellus Hartley at Columbia and Cruft at Harvard and in other Universities. But much of the equipment can be made, and not very expensively at that, by the constructor in his own laboratory. As much constructional material of that sort as possible has been and will be described in this series of articles



# The Listeners' Point of View

Conducted by ..... John Wallace

## Wanted: A Radio Shakespeare!

**F**ROM Mr. Edgar H. Felix of New York City we have received the following pregnant theme, upon which he has invited us to improvise variations:

"One of the problems which vex radio program managers is the discovery of suitable text for dramatic recitations. More frequently than not, the broadcast listener finds the efforts of would-be dramatic artists a program of confusion because so much that is essential is either missing or requires the bolstering of tedious announcement. One outstanding exception is found in the prolific works of Shakespeare, which offer a repertoire to meet the needs of every conceivable kind of dramatic talent.

"Shakespeare contended with the very problems which make broadcasting performances fail. He, too, was practically limited to the sense of hearing in his presentations, because stage lighting and scenery were not developed in his day. A few uncertain candles, which hardly served to guide the almost unseen actors to their position on the stage, were the only sources of illumination. There was no scenery; colored drapes indicated the surroundings; green a field, blue a sea, and so forth.

"Appreciating these handicaps, Shakespeare always worked into the actor's lines all the essential information which makes an aural rendition both understandable and enjoyable. There is a wealth of description which performs the function now served by stage setting, scenery, and illumination, and which permits of complete appreciation through the medium of the microphone."

By way of checking up on Mr. Felix's very interesting point, we picked up a volume of Shakespeare—it happened to be *Hamlet*—and found

in the first ten lines examined a demonstration of the truth of Mr. Felix's suggestion: "Shakespeare always worked into the actor's lines all essential information."

### HAMLET

#### ACT ONE SCENE ONE

*Elsinore. A Platform before the Castle*  
Francisco at his post. Enter to him Bernardo.

*Bernardo.* Who's there?  
*Francisco.* Nay, answer me: stand and unfold yourself.  
*Bernardo.* Long live the king!  
*Francisco.* Bernardo?  
*Bernardo.* He.  
*Francisco.* You come most carefully upon your hour.  
*Bernardo.* 'Tis now struck twelve; get thee to bed, Francisco.  
*Francisco.* For this relief much thanks: 'tis bitter cold, and I am sick at heart.  
*Bernardo.* Have you had a quiet guard?  
*Francisco.* Not a mouse stirring.

This play was probably first presented in broad daylight, in a circular, roofless building (as this sort of theater preceded the walled in, candle-lit type). Doubtless

a hot noon-day sun was beating down on the actors while they recited their lines. Probably there was no scenery. Yet all necessary information was conveyed to the audience of London citizenry, and not in an obvious and uncomfortable manner. First they were told the names of the characters. Secondly they were informed that it was twelve o'clock at night. Thirdly they learned that it was bitter cold. And fourthly, that the death-like silence of midnight prevailed (though probably the theatre was echoing with the noise of boisterous late comers).

Mr. Felix's immediate point, and a well taken one, is that Shakespeare be drawn on more frequently for dramatic recitations. As a matter of record this has occasionally been done. We have happened on a couple of instances. The "To be or not to be" soliloquy was recited by Basil Sydney, the star of *Hamlet—In Modern Dress* over some time ago. This station also presented a group of readings, by whom we've forgotten, from *The Taming of the Shrew* and *Macbeth*. Station KOA had a program in which one John Connery portrayed the various characters in the grave-digger scene from *Hamlet*.

However, even at best, it seems unlikely that recitations will ever make an astounding success with radio audiences. The most potent idea suggested by the above letter, we think, is that all aspiring radio-playwrights be required to read and assimilate in their entirety each and every one of Shakespeare's dramas.

For the radio play has, to date, proved to be an utter and complete wash-out. Of the many we have heard we know of no one we would call a complete success. Several were fair. The large majority were terrible. Once we thought we had



### THIS

Gentle reader, is not the culinary staff of WGY broadcasting recipes for home brew but the Players of said station putting over a one-act play called "Danger" and having to do with lovers buried in a coal mine

a good one: it had held us breathless, spell-bound, and so forth, for fully ten minutes—but just then a shooting occurred and we spent the rest of the play trying to figure out who in thunder had been killed.

Now if recollection immediately rushes to your mind of some radio play which you heard and thought was a wow, we plead guilty to an occasional absence from the loud speaker and protest that that must have been one we slipped up on. Dwelling upon those we have heard, we are unable to decide whether, as an average, the plays or the actors were worse. We're inclined to hand the palm to the latter.

But in fairness to the radio Thespians it should be observed that theirs is a more difficult task than that of their brethren on the visible boards. The stage actor is assisted by props, costume, action, gesture, and makeup. If all these accessories are of high standard, his cerebral and vocal deficiencies may be partly overlooked, or at least not seem quite so glaring.

Not so of the radio actor. His ability to put over his part is exclusively dependent upon his ability correctly to understand and interpret his lines and upon his natural vocal endowment. We advance this point, not because we think it to be an obscure one, in the ferreting out of which we have exhibited great acumen, but because, obvious as it is, it does not seem to have occurred to radio play producers. Their radio players are made up, for the most part, of second rate hams who would in no wise add to the glory of a third-rate stock company.

As a matter of fact, nothing short of an all-star cast culled from the headliners of the legitimate stage would be able to put across a flawless radio play, so difficult is the chore. Such a cast we may not expect; but at least we may ask the station directors to come a little closer to it. High school dramatics may be endured while we are waiting for little Oswald to go up for his diploma, but they are likely to be tuned-out when they come via radio.

When, occasionally, we have heard a genuinely competent and experienced troupe of players perform, they have almost invariably been weighted down by some impossible stage piece that defied their most valiant efforts to transmogrify it into a radio-piece.

Drama is one of the most difficult of all forms of writing, and, perversely, of all forms of writing the most easy to criticize. Easy to criticize because we need rely on no objective standards or canons of judgment; our personal reaction is the final criterion. We may

know nothing at all of the craft of acting, yet we are justly entitled to pass on acting. If the actor succeeds in creating the illusion of reality (or of unreality, as the case may be) we declare him to be a good actor. If he creates no illusion but simply remains an "actor" we call him a bad actor. Simple!

So we feel encouraged to state dogmatically that we have never heard a radio play worth two bent pins and war tax. For we don't recall having ever been completely absorbed in, or carried away by one. We have never experienced any difficulty in getting "back to earth" after listening to a radio play; to us at least, every radio play has remained just a "radio play" from start to finish. The reason for their unsuccess has been stated so often it has become banal: "Radio is an entirely new medium and requires an entirely new and distinct type of play." Yet, in spite of the frequent reiteration little has been done about it.

Now comes news of a new radio play contest, and our hope perks up. Perhaps something may come of it. Station WLS, of Chicago, and the Drama League of America are its joint sponsors. It is press agented as the first radio play contest in the world, which is not entirely correct. The General Electric Company opened a similar contest in 1923 which continued about six months, closing on December 31 of that year. In this contest a \$500 prize was offered for the best play, and ten additional prizes were given for manuscripts thought to be satisfactory for radio presentation. WGBS, New York, conducted one last year, and several others of purely local import have been held. But at any rate the WLS contest is a pretentious undertaking and should bring interesting results.

The prizes are sizable if not munificent; first award is \$500. And the judges are George Arliss, Augustus Thomas, and James O'Donnell Bennett. Doubtless by the time this appears in print, the prizes

will have been long awarded and the plays will have been aërially presented. But the rules governing the contest may be still of interest and we quote some of them, as outlined by George Junkin, field secretary of the Drama League:

Radio will not allow any sly stage business. Glances, asides and business with props cannot be put over, to the radio audience. Entrances and exits must in some way be told in the action of the play. Just as the movies brought about the new drama and a new way of presenting it, so will radio. Sounds will be the principal vehicle. Bells of all sorts, church, dinner, telephone, house and others can be used to advantage. Rain, storms, musical backgrounds, horse, airplanes, automobiles, all have sounds which can be duplicated and will lend life to the words and action of the radio play.

Any play submitted must be original and not have been printed.

Original one-act plays, eighteen to twenty-five minutes in length.

Few characters—maximum, five principals.

Accompany action with appropriate sounds.

Farce, comedy, drama, melodrama, tragedy and mystery plays.

Plays must be clean, wholesome material.

Plays should not have material which would be objectionable to any sect or nationality.

Write plays as though they were to be produced for the blind.

Everything necessary in the action must be made plain.

With due appreciation of Mr. Junkin's suggestions, we hope that too many contestants will not go in for the clanging bells, galloping hoofs, and wailing wind effects. Little gain can come from such-like trickery. In the final analysis it's the words, words, words that count. Just as the radio actor has to have a better command of his voice and inflection than the legitimate actor, so the radio playwright has to have a better command of the President's English. With neither scenery nor action to fill in his gaps of thought he is up against a problem even harder than Shakespeare had to face. So it would seem that the radio playwright

who would do his job in the best possible manner will need to possess slightly more ability than Shakespeare. Here's hoping such a man comes to light!

### Dinner Orchestras: Excellent Radio Features

ONE of the pleasanter features of radio is the dinner orchestra. As radio standards go, the dinner orchestras occupy a lofty position on their respective programs. This is particularly true of some of the smaller stations. Located, as they often are, in towns where there is a decided dearth of



CYRIL MAUDE

The famous English stage star, familiar to many theatregoers who saw him in "Are'n't We All?" and "These Charming People," shown here listening to an American radio receiver in use in his apartment in New York. Mr. Maude has, so far, ventured no authoritative opinions on a comparison of English and American broadcasting



FREDERICK STOCK

Conductor of the Chicago Symphony Orchestra, which was heard some time ago through WMAQ of that city

available talent (and where there should never have been a radio station) the best broadcast material available is often the orchestra at the local hospice. In larger cities the membership of these bands often includes recruits from first rate symphony orchestras.

It is safe to guess that some hundred thousands of our citizenry dine nightly to radio music. And if a careful job of tuning has been done, and a mild pianissimo applied, these radio strains wafting in from the front parlor, add considerably to the relish of home cooked victuals—to say nothing of the delightful possibility of an occasional healthy obligatto of static, under cover of which one may really enjoy one's soup or celery.

Among the dinner bands we have listened to, we give the KDKA Little Symphony Orchestra a class A position. This is one of the few stations that, itself, supplies the orchestra. Next comes to mind the Commodore Hotel concerts from WJZ and the Waldorf Astoria Rose Room orchestra heard through WEAJ. Close to the top of the list come the Drake Concert Ensemble and the Blackstone String Quintette heard through WLIB (or WGN). These two orchestras are picked up so as to alternate numbers.

The Brown Palace String Orchestra at Denver, offered by KOA is very good. KOA relays the dinner music of a caravansary called Roberts-at-the-Beach, which comes in a bit later than our customary dining hour. From Detroit comes Jules Klein's Hotel Statler Orchestra, via WWJ. WSM, at Nashville, offers Francis Craig's Hermitage Hotel orchestra on alternate nights and KGW at Portland, Oregon, presents a first rate trio from six to seven.

### Will Broadcast Stations Ever Specialize?

ONE of the planks in the platform of this polite if not pertinent purveyor of program piffle is that radio stations be constrained to specialize.

Specialization will eventually overtake the radio industry just as surely as it has the magazine business, and every other entertainment dispensary. At some future date we shall rant on at great length in these pages in an attempt to prove this point, which, since it is transparently obvious, should not be too much of a chore. For the present we shall be content to record joyfully the advent of two stations whose announced policy is to specialize.

WBAL at Baltimore, operated by the Consolidated Gas Electric Light and Power company of that city, broadcast the following manifesto on its opening night:

In its desire to be known as the radio station of good music rather than merely "another station of the air," WBAL hopes to attain an enviable distinction. If this station gives Baltimore a reputation for broadcasting good music, well performed, in a distinctive manner, it will serve the city better than if it tried to compete with the general run of stations by doing exactly what they do.

WBAL has a definite weekly program schedule: Sunday night, Twilight music (whatever that is!) Monday, Concert night; Tuesday, Ensemble night; Wednesday, silent; Thursday, Concert night; Friday, Novelty night; and Saturday, silent.

A slightly different policy is that announced by WHAP, New York:

The intention of the founders has been to establish an institution through which high ideals and standards can be expressed in the fields of education, musical art, and good citizenship. In matters of current opinion and in civic and social questions, WHAP will depart from the neutral and passive attitude generally maintained by broadcasting stations, as it has definite convictions, which will be expressed on the air.

Believing that those who favor jazz music and vaudeville songs are already receiving an ample volume of this material from other stations, WHAP will not broadcast any music of this type. Without making its musical programs at all heavy or academic, WHAP plans to arrange radio concerts that will have artistic merit, as well as entertainment value. Education is also to have a prominent place on the program, and several courses of half-hour talks are to be given by noted university lecturers. American history, English literature, and other subjects will be treated.

Of course we don't want all stations to specialize thusly, in highbrow manner—let it be in any manner they chose, as long as it is specialization. For this reason we are inclined to regret the passing of WTAS at Elgin, Illinois.

WTAS, catering to "Willie, Tommie, Annie, and Sammy" was frankly a lowbrow station—and proud of it. WTAS had thousands of devoted and enslaved listeners. If you didn't particularly snap for its offerings (nor did we) you doubtless carefully memorized its dial markings and learned to trip lightly past them. Meanwhile, your next door neighbor sought them out and enjoyed his fill of peppy pieces and flip announcing. So no harm was done.



MADAME TAMAKI MIURA

Japanese Soprano and well-known and praised interpreter of "Butterfly" who was heard in recital recently from WEBB, Chicago. We can't say who the evil genius who butted into the picture, is, but of one thing we are moderately certain. He is not an announcer

### Consistency in Programs

DEAR! O DEAR! The way of the reformer is hard! Possibly a couple of our gentle readers will recall that we towered to heights of what we considered to be righteous wrath in these columns last month in a diatribe against the "hodge-podge" program that jumps from one offering to another quicker than a nervous flee in a litter of pups.

And what was our reward? No sooner had we laid down our flaming pen than we were slapped in the face by the following notice in a local (Chicago), journal:

Symbolic of the variety which has marked the daily broadcasts of WBCN since its inception, the twenty-four-hour program which will mark the first anniversary of the station will include a creditable representation of practically every kind of talent on the air to-day. Everything from a whistler to a brass band will be offered.

There is great variety, as among the acts booked are a brass band, two dance orchestras, pipe organist, male vocal octet, male vocal quartet, mixed vocal quartet, three female vocal duos, two male vocal duos, a saxophone trio, a banjo trio, violin duo, harmonica duo, guitar duo, mandolin-guitar duo, four violin soloists, a cellist, a bagpiper, pianologist, musical reader, monologist, two dramatic readers, four speakers, an operatic soprano, an operatic tenor, three classical piano soloists, a blind tenor, three jazz piano soloists a trombonist, one harmonica soloist, three piano-accordionists, two mandolin soloists, one "song and patter" duo, a Scotch harmony duo, a mixed harmony duo, a Scotch soloist, a French barytone, an English soprano, seven other sopranos, a Swedish tenor, fourteen other tenors, a dialect singer, a negro barytone, two blues singers, a children's entertainer, two whistlers, two xylophone soloists, a basso, three classical barytones, two contraltos, one popular barytone, a girl barytone, harmonica-guitar player, eleven song writers, a barn dance fiddler and a tipple-player.

## Stories By Air

COSMO HAMILTON, the scriviner, read a specially composed radio novel over wjz recently, and since, regularly at 8 P.M. each Saturday evening, accompanied by sundry and droll remarks on the possibilities of the new medium. On the first night, he said in part:

My radio novel idea, which is not the condensation of an already written full-length novel, but of one written newly for the radio, which must take no longer than fifteen minutes to read, anticipates the time when, very shortly, the few people who still buy novels—and they are very few—will have joined the vast majority who look and listen but are physically and mentally unable to stop.

But equally entertaining was F. P. A's comment the following morning in "The Conning Tower" of the New York *World* which we cannot refrain from quoting:

Mr. Cosmo Hamilton, having said that the radio would put the spoken drama out of business, advances a parasang and predicts that the radio will make unnecessary the written novel. Novels, Mr. Hamilton forecasts, will be broadcast. And a jolly idea, too. Perhaps in a day or two we shall revise, for radio audiences, some novel or other. It would have been a glorious thing to do in the old days. There is a scene in *Ivanhoe*, for example, that goes something like this:

"My grandsire drew a good bow at Hastings."

"The foul fiend on thy grandsire and all his generation! In the clout! In the clout! A Hubert forever!"

The radio audience would listen in on this:

"Hello, folks! This is Walt Scott, from WEA, broadcasting. Well, here we are in Sherwood Forest. The boys are having a contest in archery.

There they are, folks, all lined up. Now, let's see. Well, Sir Reginald steps up and starts boasting.

"My grandpa was a curly wolf at this game," he says. "He won a cup at Hastings Field."

"So's your old man!" cried they all.

"And now, folks, while they're shooting, Miss Elsie O'Brien, who takes the part of Rebecca in the novel, will sing, 'I've an Eye for Ivanhoe.' If you like this little lady, folks, send a postal to her in care of the Waverley Length Radio Corporation, Newark, New Jersey. The Waverley Length Radio Corporation, Newark, New Jersey."

## A Leader Explodes

WE ARE in receipt of the following letter addressed to our worthy predecessor in this department:

PUEBLO, COLORADO

MR. KINGSLEY WELLES,  
Editor, "Listeners' Point of View"

SIR:

The only thing that avoided a conflagration in the local post office last night was the fact that I had the mental and moral strength to contain my wrath over a period of hours before putting it on paper.

It's all about Jazz. It seems to me that you and most of your fraternity of critics are wearing yourselves down to mere shadows over an evil which does not exist. Much as it may astound you to know it, there are those of us who prefer jazz to the more profound type of program, and oddly enough, our radio sets cost just as much to run as do those of the listeners who like the classics. Yet where is all this Jazz coming from? Out here in the great open spaces, I twirled the dials of our Roberts Knockout one night last week (it was not Sunday) and brought in fifteen stations without a single Jazz orchestra among them. I got sermons and speeches;

sopranos and bassos; cornetists, pianists, and violinists; organs, bands, long-winded announcers, and a pain in the neck. Conditions must be a lot different in New York.

It has come to the point where a person who wishes to listen to a jazz concert must wait around until ten or eleven o'clock before his wish can be fulfilled, and even then he may be disappointed. In fact, you mention a station in New York which forbids dance orchestras the air until ten-thirty. Fine! And now, let us close the air to sopranos of the coloratura variety, and to Hungarian Rhapsodies from ten-thirty on. Apropos of this discussion, I have sent a stamped, addressed envelope to Carl Dreher, who says in part: "If you want jazz issuing from your loud speaker, there are certain wavelengths in every locality where you can get it at any time." I confidently expect Mr. Dreher to solve my problem for me, with the added assurance of loud speaker volume.

For your information, may I state that KOA of Denver seems to fulfill your ideal of a broadcasting station? Twice a week for short periods they have genteel dance orchestras on the air. I pass them by rather hurriedly for the "Packard Six" of KFI which is unashamedly a dance orchestra. Incidentally, I always set my dials for KFI on Sunday night and turn on the juke afterward. They always have a program of lighter numbers for those who do not wish to go to sleep with their headphones on.

Very truly yours,

BERNARD KELLY.

If we may be permitted to rally to the defense of Mr. Welles (and incidentally to our own, as one of the "fraternity of critics" indicated above) we will hazard the guess that Mr. Welles never desired to bring conditions to such a sorry pass as Mr. Kelly seems to have found them.

On our own behalf, we sympathize entirely with Mr. Kelly's point of view the while rejoicing that he has found jazz so difficult to find. Rather too little jazz than the vast too much that prevailed until recently. With the demand for jazz bands and artists slightly greater than the supply the quality was bound to suffer. When jazz is good it is very, very good; but when it is bad it is horrid.

## Broadcast Miscellany

THE broadcasting of the autumn's football games was, by all odds, the best piece of work done by radio during the last half year. The broadcasting of basketball, hockey, and such-like games, that has been prevalent during the last few months has proved to be an unmitigated fizzle. The success of a sporting event broadcast is dependent on the listeners' ability to visualize the progress of the contest. If it is a tax on one's optics intelligently to follow the plays of a fast hockey match, it is a considerably greater strain on the mind's eye to turn the same trick. Football is fundamentally adapted to broadcasting; the game is essentially a spectacle—a series of clear cut and well defined pictures. Basketball is far from picturesque. It is all action. And the



JULES KLEIN'S HOTEL STATLER ORCHESTRA

Which plays dinner and noon-day music from wwj in Detroit. Left to right, standing: Eric Ernst, Raymond Epstein, Erick Wyle, Benjamin Culp; seated: Jules Klein, and Frank Hancock



action is too rapid to be delineated by the radio reporter with any degree of interest. We are no better able to picture the progress of the game than we are when we read a newspaper report of it.

NOT a bad idea, wor's, of celebrating a writer's birthday with a program of his brain children. On Rudyard Kipling's birth anniversary, December 30, this station broadcast a program made up of readings of his best known verse with orchestral accompaniment, and several solo renditions of poems which have been set to music. There was also a speech by Mr. Russell Doubleday, one of the members of the firm which is his American publisher. The excellent Eveready Hour over the WEA chain, on the following Tuesday, prepared as usual by Mr. Paul Stacey also reminded listeners throughout the eastern United States of Kipling's greatness.

KSD, at St. Louis, has a Thursday afternoon feature that may or may not be of interest to club women. Not being one we can't say. At any rate, the Wednesday (!) Club of St. Louis, throws its meetings open to the ladies at large every Thursday from 4 to 5 o'clock (P.M.). The program is known as the "Women's Hour." Among the subjects so far treated at its sessions are: "The Newest Things in Dramatics" and "Home Hygiene and Public Health."

THE Atwater-Kent concert programs through WEA and its chain of some fifteen stations continue to be about the best thing on the radio bill of fare. Not the least factor in their success is the fact that the series has continued so long now, and so regularly, that ninety per cent. of all listeners know its day and hour by memory and can thus plan their Sunday evenings to listen-in if they desire. The occasional almost equally excellent program from many another station is all too often lost in the shuffle.

DURING the period from January 1 to November 30 (1925), WEA was on the air almost 2800 hours; the Plant Department or technical delays caused by unavoidable equipment trouble in this time totalling slightly in excess of five hours; the studio delays or time lost between program presentations, 12 hours and the delays occasioned by sos calls from vessels in distress 17 hours.

WE DON'T want to boast about the receptive qualities of our receiver, but we are here to state that we have listened to broadcasts of the New York Philharmonic Orchestra, from wjz, out here in the wilds of Illinois, from which we have derived almost as much pleasure as from our seat in Orchestra Hall, which, to us, seems saying quite a bit for radio. And it needs kind words!

OLIVER M. SAYLER'S "Footlight and Lamplight" talks over WGBS are worth attention. Mr. Saylor relates current gossip of the stage, and reviews, in a brief and entertaining manner, recent books. The talks are on Thursday evenings at 8:30 P.M. Eastern time.

IT WAS WHAS (Louisville) we think—though we tuned-out so fast we might have got its letters wrong—that jangled our nerves like bells out of tune the other night by stating that it was "radio-casting."

CHICAGO programs are evincing a slight improvement. WJAZ has an excellent program of music Thursday nights from 10 to 12. Efforts to make some arrangement whereby the productions of the Chicago Civic Opera company could be broadcast have so far been unsuccessful. The broadcasting of opera involves a myriad complications. To mention only two of them: many artist's contracts prohibit broadcasting and some opera's copyrights prohibit broadcasting.

THE Cincinnati Symphony Orchestra is on the air once a month during a series of twenty community radio concerts being broadcast in the name of the community of Cincinnati through WSAI. Fritz Reiner is conductor of this orchestra. Its engagement was in response to a popular demand among listeners throughout the country, nearly 3000 letters having been received after its first concert urging repetitions.

NOT an habitual peruser of the comic sections, and likewise by no means a faithful listener-in on the "kiddie" (Ouch!) programs, we found ourself, nevertheless, completely absorbed in Uncle Walt's (WGN) broadcast of the comics on a recent Sunday morning. Stumbling accidentally on this program, we picked up the funny paper, as instructed by the speaker, sat ourself down, and didn't get up until he had finished reading all eight pages!

BUT, withal, from Chicago comes the high-spot in programs since last writing. The Chicago Symphony Orchestra, which has never before consented to broadcast its concerts at last agreed to furnish a two-hour program, which was picked up by WMAQ for the opening program of its new 1000-watt apparatus.

The concert was one of a regular series conducted by Frederick Stock. As a musical offering it was the equal of anything that has yet been tendered us by radio. Of course there was the inevitable muffling of some of the instruments, especially during loud passages—but on the whole a good job for non-studio broadcasting. To date no promise has been made of further concerts.

THIS year of grace 1926 was ushered in by the ringing of Liberty Bell at the stroke of midnight on New Year's eve. Station WIP broadcast the historic gong at the conclusion of an official ceremony inaugurating Philadelphia's Sesquicentennial year.



THE KGW DINNER CONCERT TRIO

Who are heard nightly from station KGW of the Portland *Oregonian*. The personnel and instrumentation reading from left to right: Gladys Johnson, 'cellist; Julius Walter, pianist; Abe Bercovitz, violinist. They are presented through the courtesy of Olds, Wortman & King, of Portland

# An All Purpose Coil Winder

*How to Make and Use a Simple Coil Winder for Solenoid and Lorenz Type Coils Together With Useful Inductance Tables*



By EDWARD THATCHER

AS LONG as radio constructors assemble sets, there will be those who want to make the coils they use in the set with their own hands. There are, of course, plenty who have no desire to wind their own coils any more than they care to make an audio transformer or wind a set of bobbins for head telephones. So many of our readers write in for information on how to wind this or that sort of coil that the information contained here should be of wide interest. Practically every common type of coil can be made with this simple device, from the simple solenoid to the more complex diamond and basketweave types. The inclusion of an ingenious turn-counter makes the device of great practical value. Many examples of Mr. Thatcher's work in other, non-radio, lines, have appeared in *The Ladies' Home Journal* and other publications. He is especially known for his excellent amateur ship models.—THE EDITOR.

old discarded auto speedometer, which may be purchased for about a dollar at most auto junk yards. Perhaps a search of the home garage may result in finding one. A bicycle cyclometer may also be used, if a few slight alterations are made. Fig. 2 shows such a cyclometer mounted. This one cost 85 cents at a mail order house. The various forms used with the simple machine are shown in Figs. 4, 5, 6, 7, 8, and in the top illustration on this page. These will be described in detail later on. It might be well to mention here that these same forms may be found very convenient for hand winding if you do not care to make the machine.

In Fig. 3 may be seen the coil winder and counter unassembled. The hook J, is exactly similar to the one used to make the handle I.

It should be understood that the dimensions given for the coil winder and counter may be made to suit individual needs, those given being found convenient for most of the coils which have come to the writer's attention.

The frame is made from soft pine wood taken from a packing box. A saw, plane, drills, and a hammer, are the only tools necessary for this part of the work. All the parts should be very carefully marked out and squared up before cutting them out.

MOST of us who tinker with radio know the bother of keeping count of the turns of wire on a coil as it is being wound, or of counting the turns after the coil is finished, particularly with such coils as the basketweave type or other coils of a similar nature.

With the simple coil winder and counter shown in Fig. 1, and some simple forms which are easy to make, you may wind practically any type of continuously wound coil very easily, and enjoy a smoke at the same time if you care to. You may stop winding to light your pipe and resume operations sure that the turns will be counted correctly, and if you should accidentally wind on too many turns, you may easily unwind them. The counter will always show the number of turns on the coil.

This coil winder and counter is in the form of a very simple lathe, the counter being nothing more than part of an

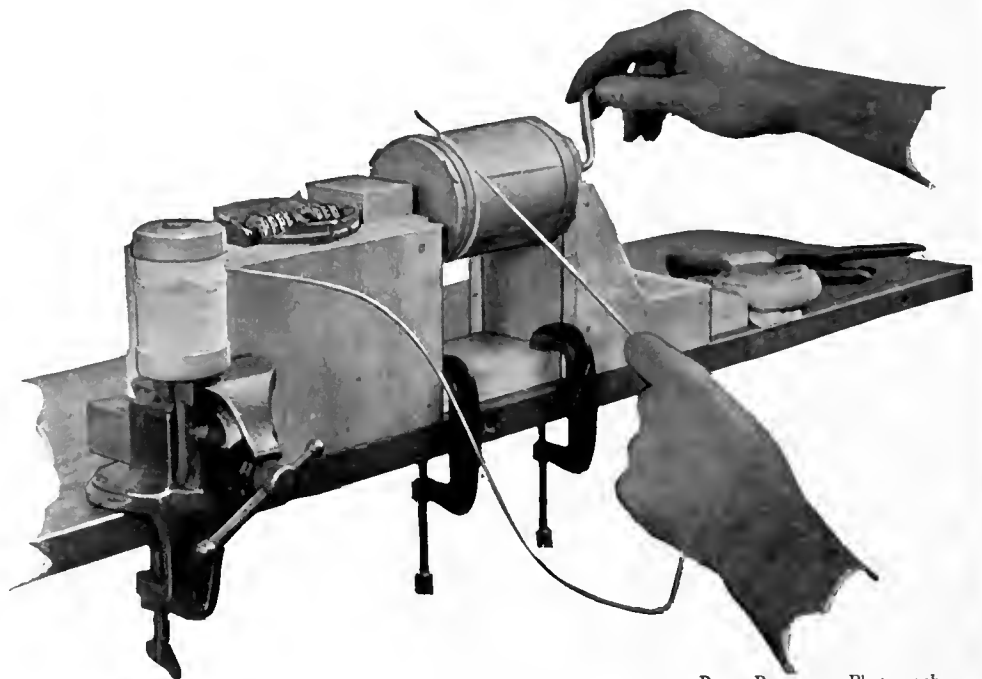
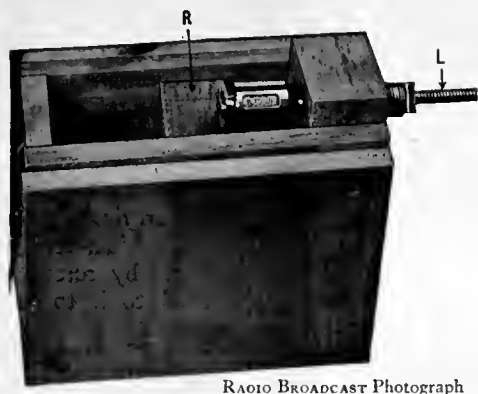

FIG. 1

The inexpensive, easily made coil winder and counter is illustrated "in action" here. With the aid of this device high grade coils are within the reach of all home-constructors and experimenters



RADIO BROADCAST Photograph

FIG. 2

A cyclometer type of turn-counter which may be satisfactorily used. Your local hardware or bicycle store can supply you with a similar one

In Fig. 3, A is the baseboard or bed of the winder. This is  $\frac{3}{4}$  inch thick,  $2\frac{5}{8}$  inches wide, and 18 inches long. B-B are two pieces which are used to support the counter. Each piece is  $\frac{1}{16}$  inch thick ( $\frac{3}{8}$  or  $\frac{1}{2}$  inch will do as well),  $4\frac{1}{2}$  inches high, and 6 inches long. These pieces are glued, nailed, or screwed to one end of the baseboard.

C is the base of the sliding tailstock, and is  $\frac{3}{4}$  inch thick,  $2\frac{1}{8}$  inches wide, and  $5\frac{1}{2}$  inches long. A slot G  $\frac{1}{4}$  inch wide and  $3\frac{1}{2}$  inches long is centered in this base. The screw F passes through the slot G into the baseboard A, and is tightened up to hold the tailstock in position. The two pieces E-E are made of wood  $\frac{1}{16}$  or  $\frac{3}{8}$  inch thick, and each piece is  $5\frac{1}{4}$  inches long. Each of these pieces is sawn out to make room for turning the handle I, a coping or compass saw being used for this purpose. These two pieces, E-E, are glued and either nailed or screwed to pieces D and C, the end of piece D resting on top of piece C.

Piece D is  $\frac{3}{4}$  inch thick,  $2\frac{1}{8}$  inches wide, and  $4\frac{1}{4}$  inches high. In this piece is drilled the hole H, into which the handle is pushed and allowed to turn easily. The position for this hole is best found by sliding the tailstock along the bed until the end of the stovebolt used to make the counter shaft, rests against D, when the counter is mounted in position between the pieces B-B.

The handle I is made of a common screwhook. This is 4 inches in length and made of stock about  $\frac{1}{4}$  inch in diameter, a common size obtainable at most hardware and 10-cent stores. To transform the screwhook into a screw handle, place it upright in the vise jaws, the hook end uppermost, with the bend just

above the top of the jaws. Use a monkey-wrench to grasp the hook and bend it out roughly into the shape of a handle. The handle is then removed from the vise and straightened up a bit by hammering on some sort of an anvil, such as the bottom of an old flat iron, taking care not to injure the screw thread.

The screw end of the hook will be found rather blunt. This may be much improved for our purposes if the threads are filed down so that they barely show at the point, tapering up gradually to the full thread at the end, next to the handle, so that the thread is much like the threaded end of a polishing spindle. A tapered screw of this kind will enter the wood more easily, and the further it is screwed in the tighter it will hold.

THE COUNTER DEVICE

NOW for the counting head M. It is quite easy to remove the counting device from a common speedometer.

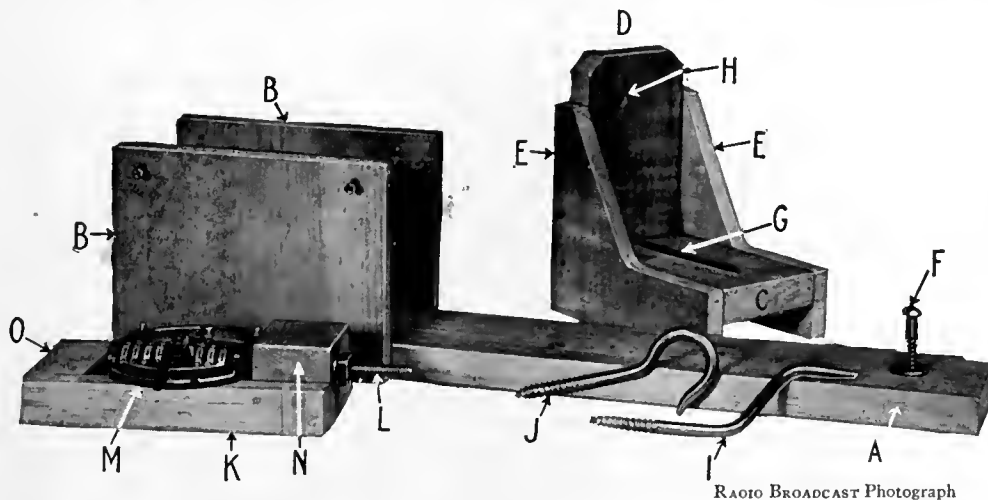

RADIO BROADCAST Photograph

FIG. 3

The coil winder partly assembled. Box wood, screw hooks, screws and a turn-counter are the requirements for the construction of this handy laboratory apparatus. The lettered parts are for identification with the Material List and refer directly to the description of the preparation of the material in the text

Pry off the glass cover and you will usually find that the counter may be removed by taking out a screw or two, when it may be lifted out and separated from the speed indicator. The counter probably registers a number of miles and these may be set back on the "trip" by the device found in most indicators. The total mileage however, must be turned backward if you wish it to register 0000. Unless you wish to wind coils of more than 99 turns, the total mileage indicator may be disregarded. However, it may be turned back after the counter is mounted in its frame by attaching a hand drill to it and turning it backward, or fastening the counter shaft to the chuck of a lathe head and running

it backward this way. Then you will have a counter which will register up to 9999, quite enough for most experimenters. The trip and season counters are usually connected by a simple clutch arrangement, which may be thrown in or out as you like. In the counter shown in Fig. 10, the set device is not made use of, it being a simple matter to turn the counter backward to 000 after the coil is round and before the form is removed.

The counter M, Fig. 10, is supported by a simple wooden frame which is made as follows. There are two pieces like K, each piece being  $\frac{1}{2}$  inch thick,  $\frac{3}{4}$  inch wide, and 6 inches long. These two pieces are fastened together at the head end by a block of wood N,  $1\frac{1}{2}$  inches thick or high,  $1\frac{3}{4}$  inches wide, and  $1\frac{1}{2}$  inches long. The block is glued and nailed, or screwed, to the side pieces. Through this block is drilled a hole to accommodate the stove bolt L, which should turn easily in this hole, the head of the stovebolt connecting with the end of the counter shaft, as will be described later. The exact position of this hole may best be found by experimenting with the counter resting in position, so that the hole through N is exactly in line with the center of the shaft of the counter.

The piece O is  $\frac{3}{4}$  inch thick,  $1\frac{1}{4}$  inches wide, and  $1\frac{1}{4}$  inches long. It should be understood that the dimensions of all the pieces may be changed to accommodate any particular type of speedometer you may have. If a cyclometer is used follow Fig. 2.

Now look at Fig. 11. The stovebolt L is  $\frac{1}{4}$  inch in diameter and 3 inches long. This should be provided with two nuts and one or more washers. The end of the counter shaft P, on the counter M, is filed to a flat shape like the end of a screw driver, care being taken to have the wedge-like end exactly in the center of the counter

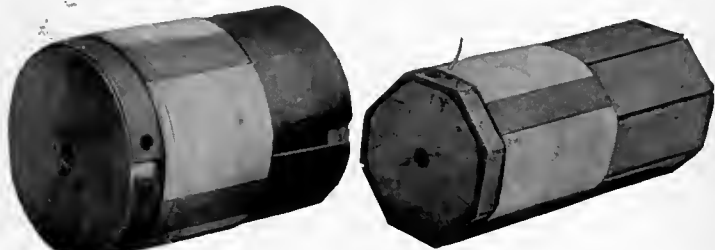

RADIO BROADCAST Photograph

FIG. 4

Here are the cylindrical and pickle-bottle coil forms with a very good example of coil binding utilizing gummed paper. Note that just below the center hole in the end piece of each coil form is situated the pin which engages in the nut on the turn-counter shaft

shaft, as this is to slip easily in the slot in the head of the stove-bolt, so that the latter may turn the counter as it is turned around by the coil form, which in turn is turned by the handle. A small hole is drilled in one corner of the nut on the stove-bolt as shown at Q, with a twist drill about  $\frac{1}{16}$  inch in diameter. A pin or brad driven in the end of each coil form fits in this hole to prevent the coil form from turning on the shaft without turning the counter, thereby causing a wrong count.

When you have the counting head ready to assemble, slip the stovebolt through the hole in N, place a washer on the threaded end, and then screw on the nut with the hole Q in it until it is fixed very tightly on the end of the thread, taking care, of course, that the stovebolt turns easily without undue play. The counter M should then be mounted on its wooden frame and screwed to it, so that every time the stovebolt makes one revolution the counter will register. Remember that the red figures on the counter are tenths and the black figures on the wheel next to the red figures will count one for every turn of the shaft.

ADJUSTING A CYCLOMETER

A CYCLOMETER also makes a very good counter. It will have to be tinkered with a bit, however, before it will count one for every turn of the shaft. The cyclometer shown in Fig. 2 was treated as follows. The disk-like end opposite the star wheel was removed by placing the points of a small pair of round nosed pliers in the two holes found in this end, and unscrewing it. Inside this disk were several washers which were removed and left out. On the end of the star wheel shaft thus exposed, will be found a small brass disk. To this disk is attached a small pinion which engages a ring or internal gear attached to the first row of figures. The pinion should be soldered fast to the disk which is on the end of the star wheel shaft. It will then be locked in the ring gear turning this with the star wheel shaft, one turn, one count. Care must be taken with this soldering, and only a small amount of flux and solder are necessary.

Two small holes about  $\frac{1}{16}$  inch in diameter are then drilled about  $\frac{1}{4}$  inch apart and equidistant from the star wheel shaft, these holes being drilled in the disk attached to the end of the shaft, to which the pinion was soldered.

A "U" shaped piece was then bent out of a piece of thin steel wire taken from a paper fastener, the points of the "U" being  $\frac{1}{4}$  inch apart. The U shaped piece is then soldered in the center of the slot in the head of the stovebolt L, Fig. 2. The ends of this soldered piece of wire engage the two



FIG. 5

End pieces, coil form, and screws are all that is required to make up the cylindrical form for the sample of solenoid coil shown at the right. The wood strip indicated at A is employed as a backbone for the coil form

RADIO BROADCAST Photograph

holes drilled in the disk at the end of the star wheel shaft. The whole should be a rather loose fit to prevent binding.

To solder steel to steel you may find that your regular soldering flux used for bus bar work will not work very well. "Killed" acid is best for this purpose. This is made of muriatic acid in which as much pure zinc as possible is dissolved. To make this flux pour a small quantity of muriatic acid in an old cup. Set this cup in a pan of

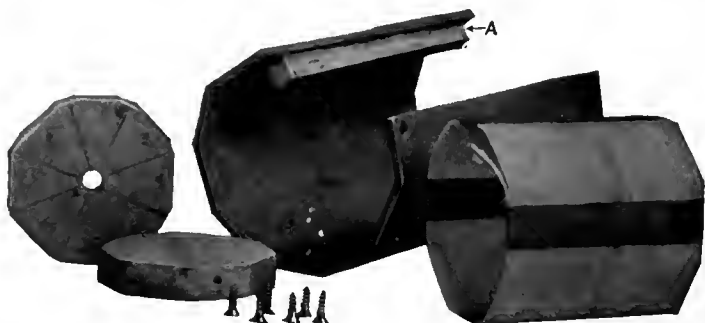

FIG. 6

Here are the parts for the pickle-bottle coil form. Low loss coils of this type of winding may easily and speedily be wound for use in the many Roberts and other circuits described in past issues of RADIO BROADCAST

RADIO BROADCAST Photograph

water to keep it cool, taking care that no water gets in the acid. Cut up a number of pieces of pure zinc (the zinc covers of old B or A battery dry cells are excellent), and put a small quantity of the zinc clippings in at a time and add to them from time to time until no more zinc will dissolve. Allow the acid to stand for a time, strain through muslin, and it is ready to use. The parts to be soldered are painted with it. Never use this flux for

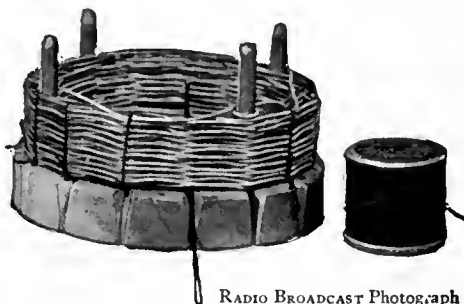

FIG. 7

The Lorenz or basketweave coil is more difficult to wind, but when finished, is one that any experimenter would be proud to use in his receiver. Substantial, well-wound coils do much to insure proper operation of one's receiver. The spool of thread also shown above is for binding the coil turns together

RADIO BROADCAST Photograph

radio or electrical work as it is very corrosive for such work. It is well to coat the solder which you are using with this flux. The flux will be found excellent for steel, iron, copper, brass, etc., when these metals are not used for carrying electric currents. The cyclometer is held to its frame by screwing the lug attached to it to the block R, Fig. 2.

COLLAPSIBLE COIL FORMS

FIGURE 1 shows the coil winder and counter in use, starting to make a low loss self-supporting solenoid coil.

The spool of wire is held by a large nail which is placed between the vise jaws, the head of the nail being tapped with a hammer until the coil of wire may be turned with just the right amount of tension.

The form used to make a solenoid coil of low loss design is shown in Fig. 5. This particular coil is of 50 turns wound over a 3-inch form. The form is partially collapsed to remove the coil when it is finished. The form may be reassembled and used over again as many times as it is desired. The outer or cylindrical part of the form shown is made out of a section cut from an ice cream container which was originally  $3\frac{1}{2}$  inches in diameter. The two wooden disks used as the ends of the form are cut to such a diameter so that when the cardboard covering is put in place over these wooden disks, the outer diameter of the

whole form is 3 inches. As the thickness of the cardboard is  $\frac{3}{8}$  inch, it will readily be seen that the diameter of the wooden ends is  $2\frac{1}{8}$  inches.

The section cut from the ice cream container is planned so that when it is screwed to the wooden ends there will be a space of from  $\frac{3}{16}$  to  $\frac{1}{4}$  inch left open between the ends, on the side, as shown in Fig. 4. Directly underneath the edges are glued narrow strips of wood about  $\frac{1}{4}$  inch square, as at A, Fig. 6. These strips of wood support the pasteboard which might otherwise be drawn in by the tension of the wire when winding a coil. These two strips should be placed in such a manner that the edges of the form may be easily pushed inward when the coil is wound and the wooden ends removed, to allow for the removal of the finished coil.

Forms for coils of practically any diameter may be made up in this manner, using such cylindrical forms as oatmeal boxes, mailing tubes, and the like.

Figs. 4 and 6 show the form used to make the pickle-bottle type of coil. Like the cylindrical form the pickle-bottle form may be used any number of times. The pasteboard used to make this form was approximately  $\frac{1}{8}$  inch thick (strawboard

taken from the sides of a packing carton). The wooden ends are then 2 inches in diameter across the flats. A pattern should first be made for these wooden ends, which are cut from soft pine about  $\frac{3}{8}$  inch thick. The outside of the form is made in one piece divided into eight equal parts, each dividing line being scored on the out-

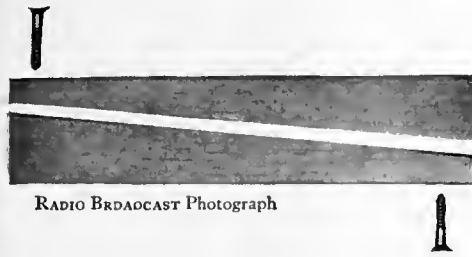

FIG. 8

When this double-wedge rectangular form is mounted in the coil winder, it is possible to wind a long strip of coil with a square cross-section, so that it may be bent into a circular form, thereby making up the much discussed toroid coil. On page 600 of this issue, Mr. John L. Lee shows in detail the constructional steps in making up such a coil

side with a sharp knife to allow the pasteboard to fold down sharply over each angle of the wooden ends to which it is screwed. A strip about  $\frac{1}{8}$  inch wide is cut off one end to prevent the edges interfering when the form is collapsed, and a strip of wood A, is glued and tacked to one or both edges at the end of the form as shown in Fig. 6. The piece (or pieces) A are just long enough to fit between the wooden ends when these are in place. The corners formed by the angles on the outer edges of these wooden forms are cut off slightly to allow for the bends in the pasteboard.

A  $\frac{1}{4}$ -inch hole is drilled in one of the wooden ends, this end being slipped over the threaded end of the stovebolt connected to the counter. A short brad is driven in this end and the head of it cut off so that it may be pushed into the hole drilled in one corner of the nut which is screwed on the stovebolt. By changing the diameter, or rather, building a similar form of any desired diameter, pickle-bottle coils may be wound as called for.

When a simple solenoid coil is to be wound, and the form is to be left inside, circular pieces of wood are sawed out to fit inside of each form and these are held with screws while the coil is being wound. Holes are of course drilled in each disk, one hole to fit over the stovebolt and

in the second disk a suitable hole is drilled into which the screw end of the handle is inserted.

WINDING A LOW LOSS SOLENOID COIL

THE coil forms shown in Figs. 4 and 5 are mounted in the winding machine as shown in Fig. 1. Four strips of gummed tape are held, gummed side up, to the form with rubber bands. The handle is shown firmly screwed into one end of the form so that it may be turned against the tension likely to be put on the wire, without slipping.

Fig. 1 also shows how the winding is started. A pin is pushed through the side of the pasteboard form where it is desired to start the winding, and the end of the wire wrapped once or twice around this pin to hold it.

The gummed side of each strip of tape is moistened with water before the winding is started. After this, the winding may be proceeded with, and if everything is right, it should go very rapidly. The speed and

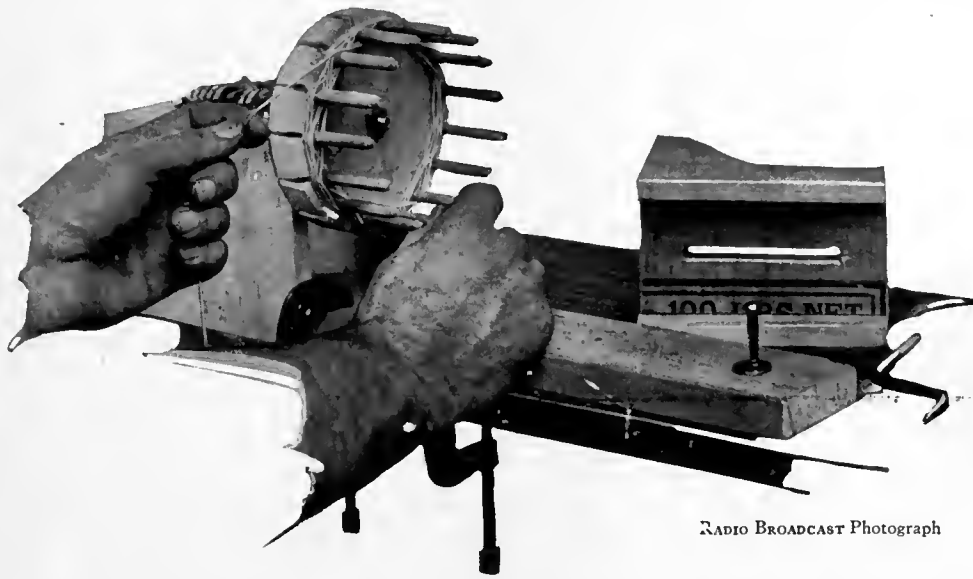

FIG. 9

"Spiderweb coil forms may be mounted in the same way as the basket-weave coil form shown here," says Mr. Thatcher. The sliding tailstock is removed when such coils are wound

accuracy with which coils may be wound on this simple machine with an occasional glance at the counter, will be only too apparent.

When the required number of turns are wound on, stick another pin through the coil form to wrap the wire on at the end of the winding while the paper tape is pasted about the coil.

Moisten the ends of the gummed paper tape which extends beyond the winding, first removing the elastic bands and proceed to fold the ends of the moistened tape over the winding, pressing each strip firmly in place.

Taps may be made in coils of this kind by lifting up a short loop of wire at the

MATERIAL LIST FOR COIL WINDER

PART	PART LETTER	DIMENSIONS	NUMBER REQUIRED
Baseboard	A	$\frac{3}{4}$ " x $2\frac{1}{2}$ " x 18"	1
Counter Supports	B	$\frac{1}{2}$ " x $4\frac{1}{2}$ " x 6"	2
Tail Stock Base Support	C	$\frac{3}{4}$ " x $2\frac{1}{2}$ " x $5\frac{1}{2}$ "	1
Tail Stock Face	D	$\frac{3}{4}$ " x $2\frac{1}{2}$ " x $4\frac{1}{2}$ "	1
Tail Stock Sides	E	$\frac{1}{8}$ " x $5\frac{1}{2}$ " shaped as shown	2
Tail Stock Screw	F	1" x No. 6 Wood Screw	1
Tail Stock Slot	G	$\frac{1}{2}$ " x $3\frac{1}{2}$ "	1
Handle Hole	H	$\frac{1}{2}$ "	1
Handle	I	$\frac{1}{2}$ " x 4"	1
Counter Base Sides	K	$\frac{1}{2}$ " x $\frac{3}{4}$ " x 6"	2
Stove Bolt	L	$\frac{1}{4}$ " x $\frac{3}{8}$ "	1
Turn Counter	M		1
Counter Head Block	N	$1\frac{1}{4}$ " x $1\frac{3}{4}$ " x $1\frac{1}{4}$ "	1
Counter End Block	O	$\frac{3}{4}$ " x $1\frac{1}{2}$ " x $1\frac{1}{4}$ "	1

No dimensions are given for coil forms as the constructor must use his own judgment in selecting the forms for the coils he wishes to wind.

desired turn, twisting it, and then going on with the winding. Another winding, such as a primary, may be wound over the first coil, after this is wound, and the tape stuck to it as usual, by wrapping a single layer of Empire tape or even gummed tape, about the first coil and then winding the second coil on this, this second coil being held together with strips of gummed tape as the first one was, the form being left in place until both coils are wound on and the gummed tape is dry. To remove the form, the screws are taken out, after the handle is unscrewed, and the coil removed from the counter head. Then the wooden ends are removed, and the pasteboard form is pressed in at the joint until the coil may be easily slipped off.

WINDING BASKETWEAVE AND DIAMONDWEAVE COILS

THE form for winding a basketweave coil is shown in Fig. 9 mounted on the counter shaft. The extra nut provided with the stovebolt is used to hold it in place, a pin in the

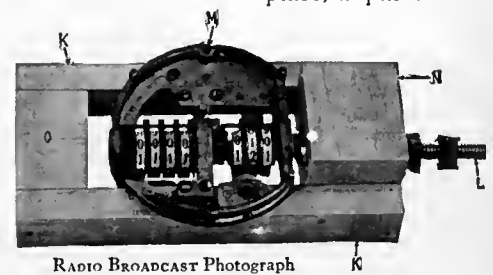

FIG. 10

Another use for the automobile speedometer—only here it tells you how far you've gone and not how fast. However, with practice, the home constructor becomes quite efficient in making the coil turns lay side by side at an exceeding high speed. For an explanation of the lettered parts, the constructor should refer to the text

SPIDERWEB COIL				
SIZE WIRE	NUMBER OF SPOKES	NUMBER OF TURNS	INSIDE DIAMETER	FREQUENCY RANGE
No. 24 d.s.c.	15	52	1½ in.	1764-500 k.c. (170-600 meters)
No. 20 d.c.c.	17	46	2 in. (no form)	2540-565 k.c. (118-529 meters)
No. 24 d.c.c.	11	50	1½ in. " "	2630-565 k.c. (114-529 meters)

BASKETWEAVE				
SIZE WIRE	NUMBER OF SPOKES	NUMBER OF TURNS	INSIDE DIAMETER	FREQUENCY RANGE
No. 18 Enamel d.c.c.	13	58	2½" between peg centers	2361-500 kc. (127-600 meters)
No. 18 d.c.c.	14	60	4½" between peg centers	2290-550 kc. (131-545 meters)
No. 24 d.s.c.	15	64	2½" between peg centers	2054-495 kc. (146-605 meters)

DIAMONDWEAVE				
SIZE WIRE	NUMBER OF SPOKES	NUMBER OF TURNS	INSIDE DIAMETER	FREQUENCY RANGE
No. 26 d.s.c.	15	57	2½ inches	2040-495 kc. (147-605 meters)
No. 20 d.c.c.	21	36	2½ inches	2650-694 kc. (113-432 meters)
No. 24 d.c.c.	15	44	2½ inches	1764-560 kc. (170-535 meters)

pictures to show up better, but plain uncolored cotton string is usually recommended for this purpose.

On the right of the top illustration on page 582 will be noticed a form for winding a diamondweave coil. Grooves are shown in the face of the central part of this form. After the wire is wound on the form, the flexible needle is used to thread the string up through the winding as each peg is removed.

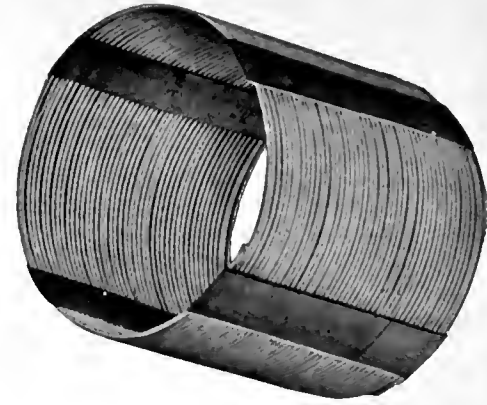

RADIO BROADCAST Photograph

FIG. 12

For the experimenter who desires the last word in low loss, Mr. Thatcher offers this space wound coil, which he wound on his indispensable coil winder. A thread is wound with the wire, separating turn from turn. When the coil is completed and fastened together, the thread is removed

DATA ON SPECIMEN COILS

THE data in the table shown elsewhere on this page will serve as a guide to those constructors wishing to wind coils for

use in tuned circuits. In the first test to determine the correct number of coil turns, a .0005-mfd. variable condenser was employed.

From the table it will be noted that for each type of coil the wire size, number of spokes, number of turns, and coil diameter is different for each three examples, yet the frequency spectrum (wavelength range) does not differ greatly.

With a .00035-mfd. variable condenser, the secondary sizes for the above types of coils will take not more than 80 turns. Usually .77 is correct. The correct value varies slightly with changes in coil diameter and wire size. If the tuned circuit is found to tune to frequencies below the range desired, then remove a turn at a time until the lowest frequency (longest wave) you wish to tune to is tuned-in somewhere near the high end of the condenser scale, usually between 90 and 100.

The primary and tickler coils for use with these secondaries should have about one third the number of turns as the secondaries. For a tuned radio-frequency amplifier circuit, employing no neutralization system, it will be well to reduce the primary turns to from six to ten, otherwise oscillation in each stage will be uncontrollable.

It will be observed that the number of turns for a coil, tuned with a .0005-mfd. condenser, is approximately 60, and conforms to a certain degree with the Inductance chart prepared by Mr. Homer Davis on page 587.

With this coil winder it is also very easy to make up such coils as are shown in Fig. 12, which represents the

latest design in space wound solenoids. An ordinary cylindrical form can be used, such as is shown in Fig. 5. A piece of heavy thread is wound in parallel with the wire so that all the turns are separated, and when the coil is finally completed, the thread separator is removed leaving a space wound solenoid very well adapted for use in tuned radio frequency circuits. Adhesive tape is employed to keep the coil together. By referring to Fig. 12 it will be clearly seen how the tape is arranged.

In order to obtain the same inductance, a coil of this type will require a few more turns than are necessary for a solenoid that is not space wound. Because of its low loss features and low distributed capacity, due to the spacing between turns, the wavelength range of this coil is, in general, somewhat greater than that obtained with an unspaced winding.

other side engaging the hole in the first nut. Spiderweb coil forms may be mounted in the same way, except that a common pin may be pushed through the form, and through the hole in the nut, before the second nut is screwed in place.

It will be noticed that opposite every peg in the form shown in Figs. 7 and 9 is a deep groove, the top of which extends into the hole for the peg.

These grooves are made by first making a cut with a saw and then enlarging this with a three cornered file or a sharp knife.

The reason for these cuts is as follows: After the winding is finished, a flexible needle, about 3 inches long is used with string to sew the coil together as each peg is removed.

The flexible needle is made of a piece of copper wire about No. 20 gauge, bare or enamel covered, it being doubled to form a loop at one end. The other end, or ends, are held together by a drop of solder which is rounded over with emery cloth to remove any sharpness. The needle thus made, being very soft and flexible, may be bent to a suitable shape to be passed into the slot in the side of the form and up through the top of the winding, after each peg is removed. Black thread is used in the

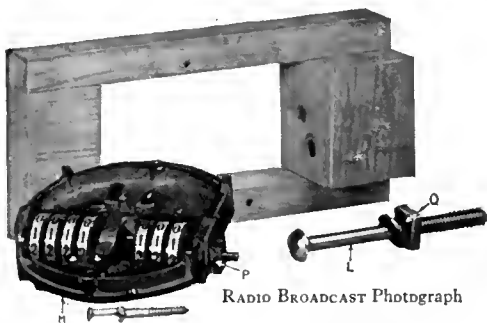

RADIO BROADCAST Photograph

FIG. 11

An unassembled view of the turn counter and support frame. With care, the shaft P should be filed so that it engages the slot in the head of the bolt L on which the coil form is mounted

B. & S. GAUGE	KIND OF INSULATION						ENAMEL	
	DCC	SCC	DSC	SSC	ENAMEL	AND SCC	AND SSC	
14	13 7	14 6	14 7	15 0	15 2	14 2	14 7	
15	15 0	16 2	16 4	17 0	17 0	15 8	16 5	
16	16 7	18 0	18 2	19 0	18 7	17 6	18 4	
17	18 5	20 0	20 0	21 2	21 4	19 5	20 5	
18	19 6	22 3	22 3	23 6	24 0	21 7	22 9	
19	22 5	25 0	25 2	27 0	27 2	24 2	25 8	
20	24 5	27 5	27 5	29 5	30 1	26 5	28 4	
21	27 5	30 8	30 8	32 8	33 6	29 6	31 5	
22	30 0	34 0	34 0	36 6	37 7	32 7	35 0	
23	32 7	37 5	37 5	40 7	42 3	36 1	39 0	
24	35 5	41 5	41 5	45 3	47 2	39 7	43 1	
25	38 5	45 7	45 7	50 3	52 9	43 7	47 9	
26	41 8	50 2	50 2	55 7	59 0	47 8	52 8	
27	45 0	55 0	55 0	61 7	65 8	52 1	58 1	
28	48 5	60 0	60 0	68 3	73 9	57 0	64 4	
29	52 0	65 5	65 5	75 4	82 2	61 9	70 6	
30	55 5	71 3	71 3	83 1	92 3	67 4	77 9	
31	60 0	77 3	77 3	91 6	103 0	72 8	85 3	
32	62 7	83 7	83 7	101 0	116 0	79 1	93 9	
33	66 3	90 3	90 3	110 0	130 0	85 6	103 0	
34	70 0	97 0	97 0	120 0	145 0	91 7	112 0	
35	73 4	104 0	104 0	131 0	164 0	98 8	123 0	
36	77 0	111 0	111 0	143 0	182 0	105 0	133 0	
37	80 3	126 0	126 0	155 0	206 0	113 0	146 0	
38	83 5	133 0	133 0	168 0	235 0	120 0	157 0	
39	89 7	140 0	140 0	181 0	261 0	128 0	172 0	

FIG 13

This table, giving the number of turns per inch of various kinds of wire, is to be used in conjunction with the capacity-inductance data table printed on the following page

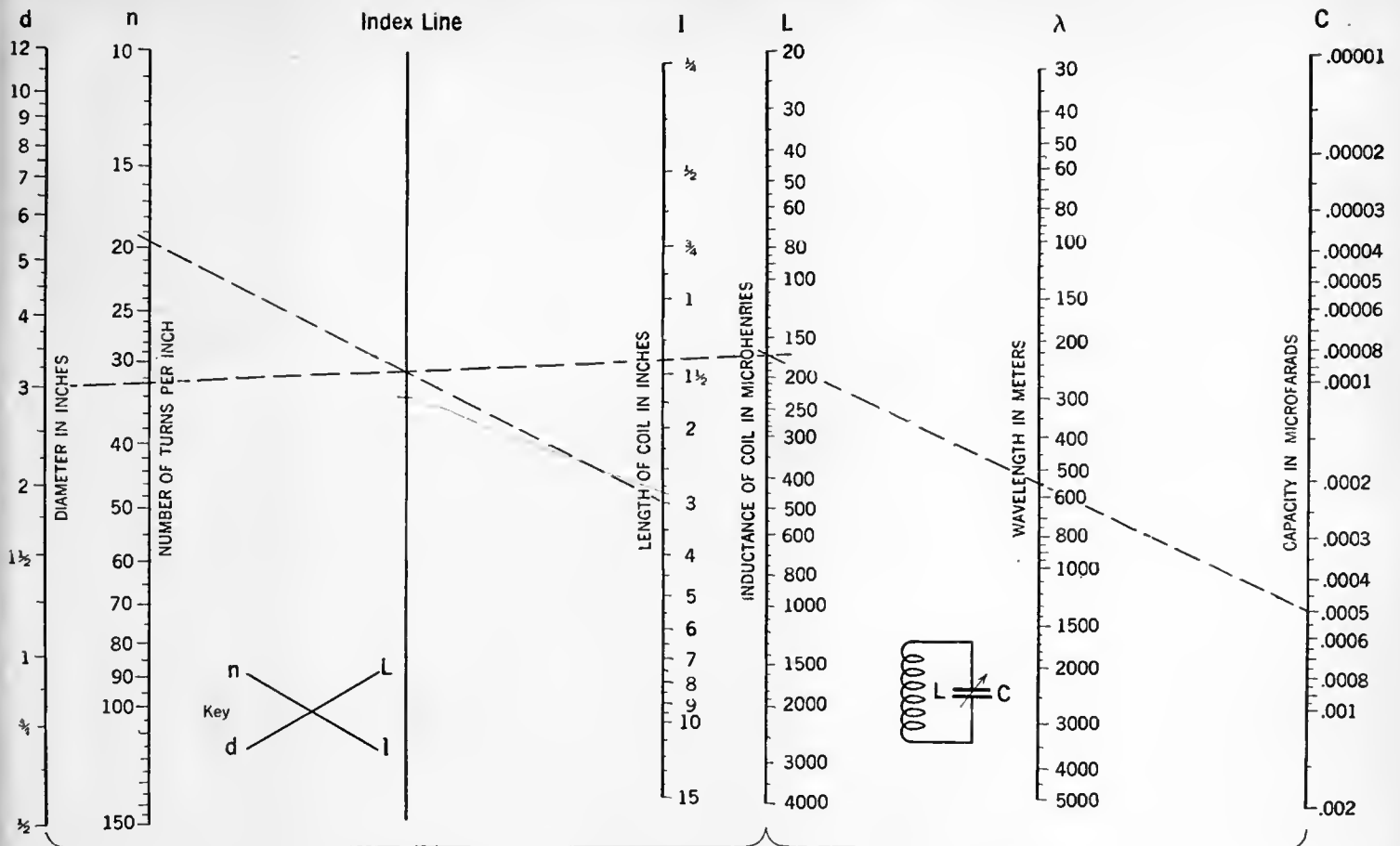

CHART II

CHART I

Connect three known values as per key, and read fourth at point of intersection.

Example: If L=170 mh., d=3" and n=196, then l=3"

Connect two known values and read third at point of intersection.

Example: If λ = 550 m. and C=.0005 mfd then L 170 mh

COIL DATA CHART

With the aid of this chart, a ruler, and pencil, the experimenter can very simply determine the approximate specifications for a solenoid coil to cover a definite frequency spectrum (wavelength range) with any condenser on hand. Full information for its use was contained in an article by Mr. Homer Davis, on page 46 of the May, 1925, issue of RADIO BROADCAST.

Briefly, the chart is used in the following manner:

Suppose the constructor has a .0005-mfd. variable condenser and he wishes to cover a tuning range whose extremes are 545 kc. and 1500 kc. (550 to 200 meters). Therefore, he must wind a coil so that, with the condenser plates entirely meshed, the tuned circuit, comprising coil and condenser, will respond to 545 kc. (550 meters). The problem is to first determine the inductance value in microhenries. By connecting together with a ruler and pencil the values of capacity (.0005 mfd.) on column C and the wavelength extreme (550 meters) on column λ (wavelength), and continuing this line so that it intersects column L, a value of L (inductance) is denoted.

Now, knowing the size of wire he is to use, the constructor looks for the number of turns to the inch for that particular size of wire as indicated on the wire table, Fig. 13, and then spots this position on column "n" above. If No. 18 d.c.c. is to be used, the number of turns per inch will be 19.6. Then he, knowing the diameter of the coil he is to wind, draws a line from the diameter figure point on column "d" to the inductance value in microhenries on column L, determined previously. This latter line between d and L intersects the index line. Now from the spotting on column n (19.6 if 18 d.c.c. be employed), a line is drawn to pass through the point of intersection on the index line continuing on to the column L, thereby indicating the approximate length in inches of the coil to be wound. Knowing this value, then L times n equals the number of turns for the complete coil.

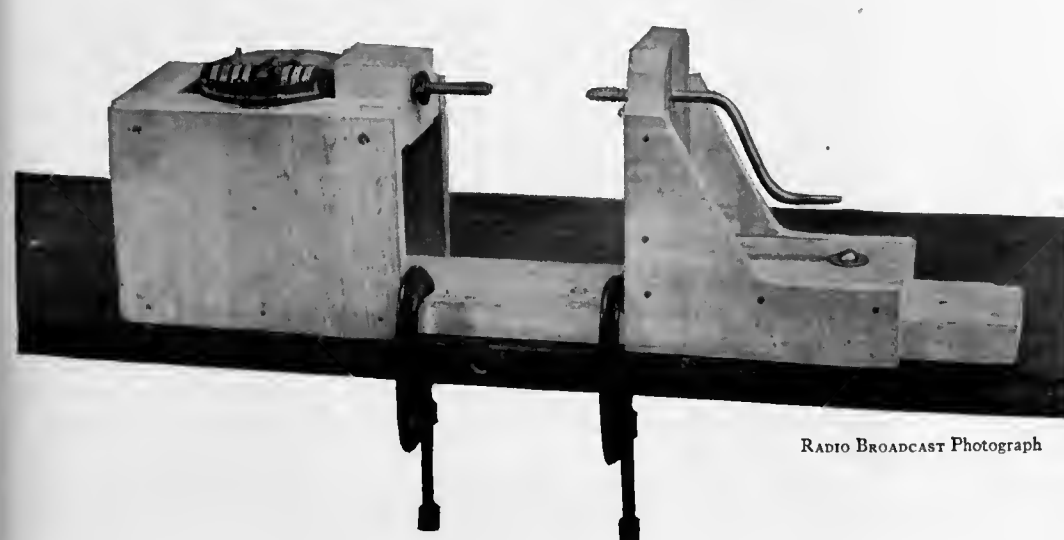

THE ASSEMBLED WINDER  
Clamped to the bench and ready for work. By comparing this picture with the illustration Fig. 1, which shows the winder in operation, it will be plainly understood how the solenoid form—and other forms too for that matter—are fixed to the winder

RADIO BROADCAST Photograph

# The First Report on the International Tests

By WILLIS K. WING

SEVERAL days before the Third International Radio Broadcast Tests are completed, it is a difficult matter to prepare anything more than what the newspapers refer to as a "bulletin" on the general success or failure of the most elaborate of the inter-nation broadcasting efforts which have yet taken place. A story on the results of the Tests will appear in RADIO BROADCAST for April, after sufficient time has elapsed for the thousands and thousands of reports to be sifted and verified. Now, with a desk loaded with telegrams and detailed reports of reception for the first few nights of the Tests, it is not possible to present all the facts. Most of the news of immediate interest to radio listeners has been furnished them already through their newspapers and in that field a monthly magazine cannot hope to compete.

But at International Test headquarters here in Garden City we have the reports of eager listeners who carefully tuned to the foreign wavelengths, and praises be to their radio souls, lots of them heard the coveted distant stations!

In brief, the first three nights of the Tests were very poor for receiving, at least on the East coast of the United States and in the Middle West. On the first two nights, reception was moderately good north and south and indifferently good east and west—the most important directions to the great body of American listeners. There were few indeed who reported reception of the English stations on Sunday, January 24th and of the Continentals on Monday, the day following. And, to top it off, and not to make excuses, but rather to state a sad fact, the oscillating receiver reared its electrical head and made reception well-nigh impossible for many listeners whose receiving equipment was efficient and sensitive enough to have a good chance of hearing the foreign broadcasts. If ever the genuine menace of the radiating receiver was demonstrated, it was demonstrated during these Tests.

On Tuesday night, the 26th, American listeners were more successful, and Cardiff and Aberdeen were reported in a considerable number of localities. Mail from the Middle and far West has not yet reached Garden City, so it is not possible to say at this time how successful listeners in those parts of the United States were in hearing English and Continental broadcasts on that night.

But on Wednesday night, the 27th, in the Eastern part of the United States, weather conditions had greatly improved and reception from the Middle European stations seemed to be much better, many verified reports being received on Hamburg and Prague, as well as on Madrid. The South American stations, too, seemed to come in better than before and the three Buenos Aires stations and the faithful OAX at Lima, Peru succeeded in reaching a considerable number of listeners.

During the first three nights of the international experiment, there were storms at sea, as a number of sos calls gave evidence that ships on the Atlantic were having their own troubles—far more serious than the uncertain reception American listeners had to face. The confirmation programs from many of the Continental broadcasters which were forwarded to Garden City by Dwight K. Tripp, the representative of RADIO BROADCAST in Paris, by

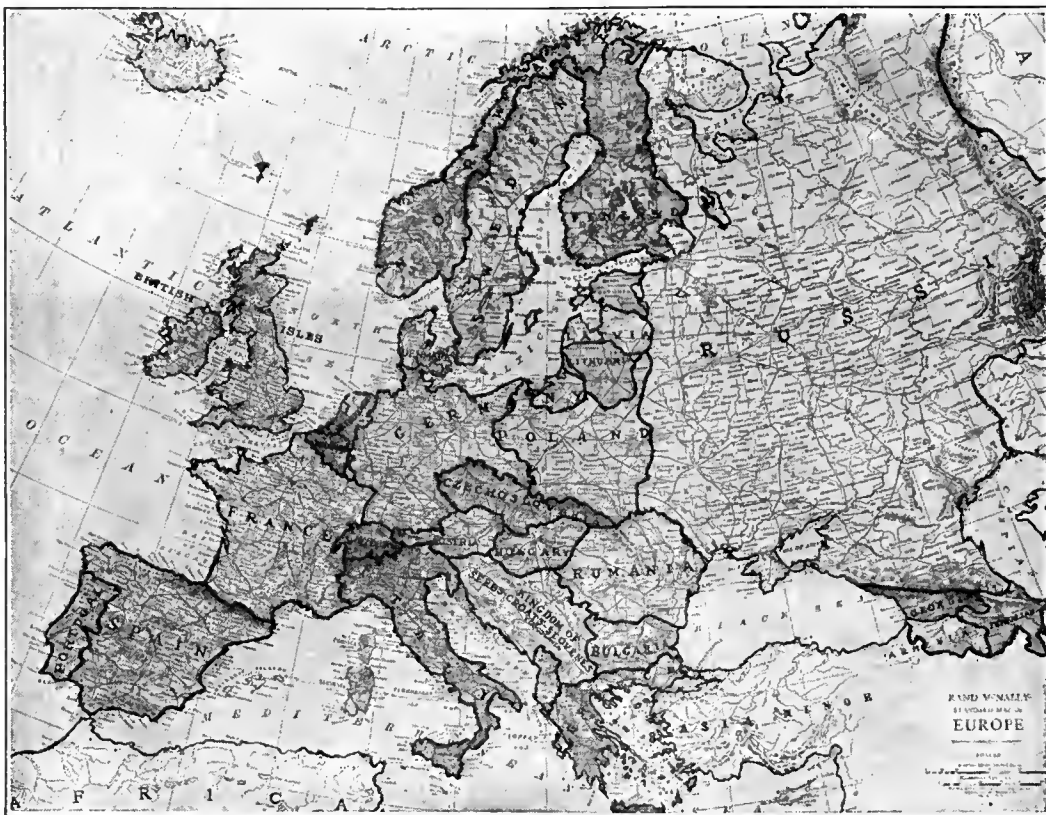

© Rand, McNally

courier on the S. S. *Leviathan* were held up two days by a delay of that length in the arrival of the ship, due to the heavy weather on the Atlantic.

Of dramatic happenings, there were many, and it is hoped they can be chronicled in the April number of this magazine. There is the story of the experiences of those of the staff who took a broadcast receiver out to a thinly populated corner of Long Island, far from telephone or telegraph and connected with headquarters only by a battery-operated short wave transmitter and receiver, but that will have to wait.

In England, early cablegrams from Percy W. Harris, editorial manager of Radio Press, the English organization appointed by RADIO BROADCAST in charge of the Tests there, indicate that our fellow British enthusiasts were not highly successful in receiving American broadcasts during the first two days of the transmissions. There has not so far been time for reports more complete than that. Receiving conditions in England seemed to be exceptionally poor during the early part of the Test week.

Reports of reception of the foreign broadcasts, which are coming in to the offices of RADIO BROADCAST by mail and telegraph are being answered as promptly and completely as possible and an official card of verification is being sent to those fortunate enough to have heard any or all of the foreign stations. Those who have not yet sent in their report are urged to mail it in and to make it as complete, but as brief, as possible.



# Super-Heterodyne Construction

*In Which the Various Sections of a Super-Heterodyne Are Described in Turn—Timely Hints and Constructional Data are Given for the Benefit of Those Contemplating the Construction of Such a Receiver*

By HAROLD C. WEBER

**A** GREAT DEAL of misunderstanding seems to exist at present in regard to just what advantage the super-heterodyne type of receiver has over other circuits. In the opinion of the writer a Roberts receiver properly constructed gives all the selectivity, and by the addition of two stages of audio frequency amplification, all the volume one could desire. It is remarkably free from distortion, and if one lives in a locality where a good outdoor antenna can be erected, there is some doubt in the author's mind as to whether the super-heterodyne will produce results any more satisfactory than those obtainable by the more simple Roberts circuit. The big advantage obtained by the use of the super-heterodyne circuit is its ability to work on a small loop and, in so doing, produce just as good results as can be obtained by other sets with the aid of an outdoor antenna. From this it can be seen that the super-heterodyne finds its greatest use in thickly populated sections where it is difficult to erect a satisfactory outdoor antenna. The builder of a super-heterodyne may expect to obtain the same results on an eighteen- or twenty-inch loop with his super-heterodyne that

he has been obtaining in the same location with an outdoor antenna on either a good neutrodyne, for example, or a Roberts set. If he lives on the Atlantic Coast, and has been unable to receive Pacific Coast stations with his Roberts or neutrodyne set, it is doubtful whether he will be able to do any better with a super-heterodyne working on a loop. Attempts to make the super work on a large outdoor antenna are for the most part unsatisfactory, due to its great sensitivity. The weakest winter static noises resembled in volume a heavy thunder-

storm, after passing through the set. Of course, working the super-heterodyne on an outdoor antenna has the further disadvantage that considerable annoyance will be caused to one's neighbors unless a buffer or blocking tube is used in front of the first detector.

The discussion will now be turned to the various component parts of the super-heterodyne, and as each section is discussed, various experimental results which have been obtained will be pointed out.

## THE FIRST DETECTOR

**T**HE first detector circuit of the beat type receiver is really little different from any other detector circuit, and it is

has tried both schemes and believes that there is nothing to be gained by the use of the bias battery. In all of the sets he has constructed results obtained with the grid leak and the grid condenser fully equal those obtained with a C battery. The use of regeneration on the first detector tube will be found helpful. This is most easily accomplished by the use of a split loop, as pointed out in Mr. Silver's article in the July, 1925, RADIO BROADCAST. It is not necessary to use the midget variable condenser as he suggested. One may wind the loop with bare copper wire, and then place the center tap on that point of the loop where the first detector just refuses to oscillate. In place of the

midget condenser a .00025-mfd. fixed condenser may then be used. If the loop contains about fourteen turns of wire, it will be found that the best point for the mid tap is approximately four turns away from that end of the loop which is connected to the grid return, or ten turns away from that side of the loop connected to the grid.

One point seems to have been overlooked in this first detector circuit by a great many constructors; that is, the necessity for providing a low resistance path for the high-

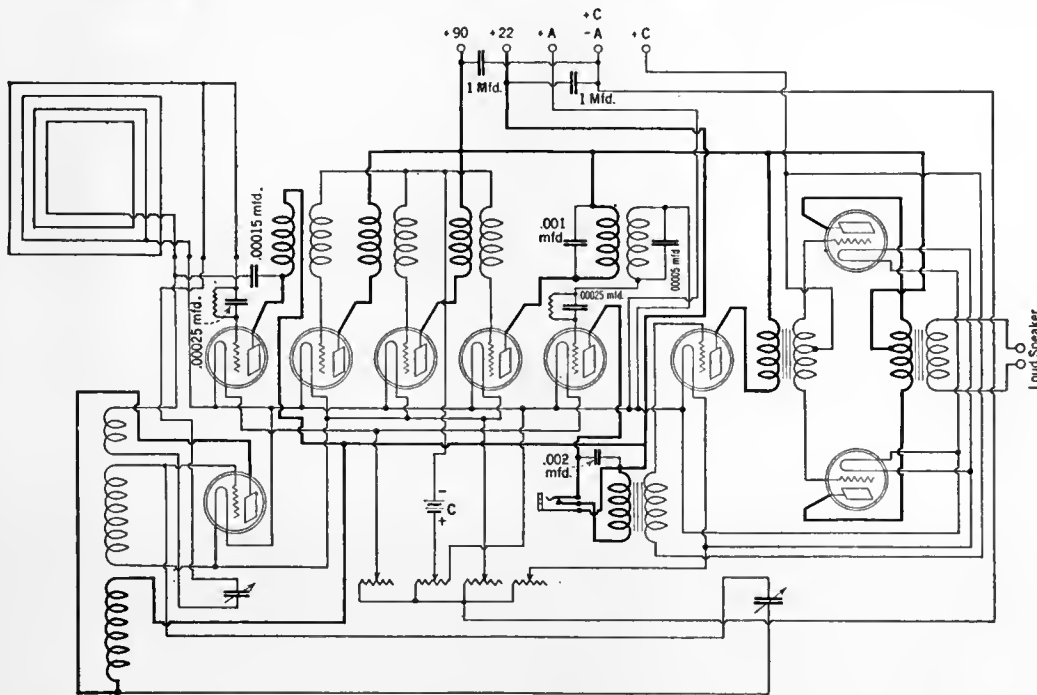

CIRCUIT DIAGRAM OF THE AUTHOR'S RECEIVER

A nine-tube super-heterodyne. The only controls appearing on the panel are the two condenser dials, three rheostat knobs, a potentiometer control, and a single jack for headphone use. The loud speaker is put in operation by merely pulling out the phone plug and turning on the audio rheostat

frequency oscillations in the plate circuit of the first detector. No one would think of constructing a single-tube regenerative set without the use of a proper phone bypass condenser, and yet a great many super-heterodyne constructors neglect to use a bypass condenser at the same point in their super. This bypass condenser need not be larger than about .00015 to .00025 mfd. and, in fact, if the split-loop method is used, the condenser which must be included in the circuit will serve the double purpose of providing regenerative feed-

imperative that if one wishes to obtain satisfactory results the same care be exercised in building this part of the set as would be exercised in the construction of any good low loss one-tube receiver. This means that the condenser used for tuning the loop must be a good one. Its capacity should not be more than .0005-mfd., and it should be equipped with a smooth-acting vernier dial. Considerable discussion has been raised as to whether this first detector circuit should be operated with a grid leak and a grid condenser or with a C battery. The author

back and a low-resistance path for the high-frequency currents. The detector circuit must be coupled to the oscillator in some manner, and this can be done by coupling on to the plate circuit of the detector or to the grid circuit. Personally, the author feels that slightly better results are obtained by grid-circuit coupling than by plate-circuit coupling. The pickup coil may be placed either on the grid side of the loop or on the grid return side. The most satisfactory place for this coil seems to be between the grid return and that point where the tuning condenser connects to the loop. The coupling coil is shown connected in this position in Fig. 1.

Here again authors seem to differ as to the proper number of turns to be used for coupling. Anything from one turn to six turns seems to work satisfactorily on the broadcast wavelengths. Results obtained using from about six to thirty-five turns seem to be somewhat less satisfactory. Satisfactory operation is again obtained by the use of anywhere from thirty-five to fifty turns on the coupling coil. This may mean that the detector circuit can be coupled to the oscillator circuit either capacitively or inductively. Evidently, the transfer of energy is mostly by induction with the low number of turns in the coupling coil, and perhaps mostly by capacity when a large number of turns is used. It does seem, however, that there is a range from approximately six to twenty-five or thirty turns where results are inferior to those obtained either above or below this figure. Incidentally, there appears to be little actual advantage gained in making the coupling coil movable.

#### THE OSCILLATOR

THE oscillator is an extremely important part of any super-heterodyne. The author has found the Hartley oscillator circuit to be the most satisfactory. If a

30-kc. (10,000-meter) wave is used on the intermediate amplifier, a suitable construction for the coils in this circuit is twenty-seven turn coils wound with No. 22 or 24 double silk-covered wire on a thin bakelite or cardboard tube, approximately  $2\frac{3}{4}$  inches in diameter. Both coils are wound in the same direction. The proper method of connecting these coils in the oscillator circuit is shown in Fig. 2, and the coupling coil in the first detector circuit should be placed at the grid coil end of the oscillator coil unit rather than at the plate coil end.

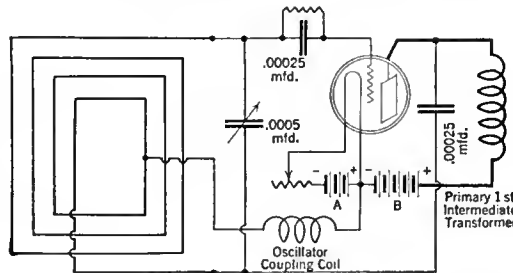

FIG. 1

Serious difficulty will no doubt be experienced with harmonics if one attempts to use more than twenty-five or thirty volts on the oscillator tube. Perfectly satisfactory results can be obtained with ten or twelve volts on the oscillator tube using 201-A type tubes. If the coupling coil of the first detector is coupled too closely to the oscillator circuit, some difficulty may occur, due to the fact that the oscillator will stop functioning whenever the first detector is tuned to approximately the same wavelength as the oscillator. This difficulty is easily overcome by loosening the coupling between the detector and oscillator circuits.

Too much care cannot be exercised in the selection of a suitable tube for use in the oscillator. This is one of the most critical tubes in the whole set, and several should be tried in this position until one is found

that functions satisfactorily. No station should be heard at more than two points on the oscillator dial in a properly constructed super-heterodyne. Most stations, even powerful locals four or five miles away, can be completely tuned out by a movement of less than one degree on the oscillator dial if the set is working properly. The same sharpness of tuning holds for the first detector circuit, if proper care is used in its construction, and low-loss parts are used throughout.

#### INTERMEDIATE FREQUENCY AMPLIFIER

SO MUCH has been said about intermediate-frequency amplifiers in various articles that the author really hesitates to add anything. A long discussion has been waged as to the relative merits of the air-core transformer versus the iron-core. It is usually admitted that it is much easier to amplify at a frequency of thirty kilocycles than at the higher frequencies to which most air-core transformers are tuned. Most iron-core transformers have their peak at about thirty kilocycles (10,000 meters), whereas the air-core transformers work at a very much higher frequency (shorter wavelength). This means among other things that, in general, more grid bias can be applied to an intermediate-frequency amplifier, using iron-core transformers, than to one using air-core transformers. Of course, increasing the grid bias decreases the B battery consumption, and when one is using anywhere from six to nine tubes, B battery current becomes an item of major importance. Offsetting this gain obtained by the use of iron-core transformers rather than air-core ones is the fact that unless the iron-core instrument is carefully designed, there is a great tendency for it to amplify at audio frequency, and therefore to be very noisy. If one uses the higher grade types of iron-core transformers now available, no difficulty will be experienced with noises from the intermediate-frequency amplifier.

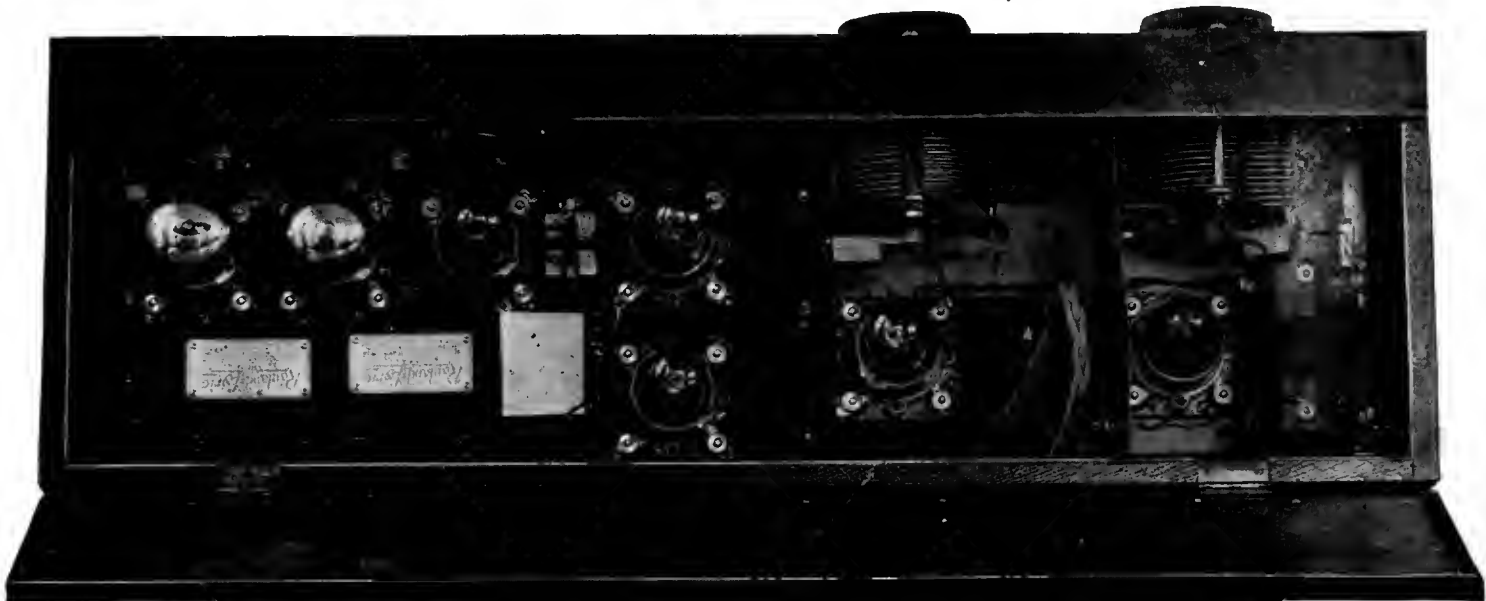

RADIO BROADCAST Photograph

#### A SEVEN-TUBE SUPER-HETERODYNE

Note the copper shield between the first and second tube units (at the right)

If the set is properly constructed, the intermediate-frequency amplifier often can be run with the potentiometer arm completely over to the negative side, and it will be found that often a few volts of C battery can be added to this circuit.

It is claimed that, unless the set is very thoroughly shielded, ten-thousand meter transformers will be likely to pick up long-wave code signals. It is felt that most of the trouble experienced by the users of ten-thousand meter transformers in this respect is due to the fact that their leads have been made too long. The best plan at the present time seems to be to mount the long wave transformers, if they are of the iron core type, directly under the tubes to which they are to be connected, and then, if trouble is still experienced, to try grounding the metal casings with which most long-wave transformers are now protected. In fact, grounding the casings of these transformers is usually found advantageous in any case.

The question of tuned input versus tuned output for the intermediate-frequency amplifier has long been a debated point. It has been argued that tuned output does offer some advantage in that a sharply tuned transformer will not pass any audio frequency which may be picked up by the first transformer in the train. This tends to cut out noise in the set. The author has tried both tuned input and output on the same set, and has come to the conclusion that, with the better makes of long-wave, iron-cored radio-frequency transformers now on the market, little trouble will be experienced from transformer noises in any case. There is one advantage that the tuned input circuit does have over the output circuit. It will be remembered that reference was made to the bypass condenser which is quite necessary across the primary circuit terminals of the first long-wave transformer in the first detector circuit. Placing a bypass condenser at this point is not very helpful to the amplifying action of the transformer, providing it is an iron-core instrument; but if a tuned air-core transformer is used at this point, the fixed condenser necessary across its primary terminals serves the purpose of a bypass for the high-frequency oscillations as well as serving as a means of tuning for the transformer. From this point of view it might be argued that tuned input does have some advantage over tuned output. Of course, if one is using a split-loop method

for obtaining regeneration this advantage does not appear, and under these considerations it is doubtful whether either a tuned input or a tuned output offers any advantages. Surely any good iron-core transformer, when used in a properly constructed super-heterodyne, will give all the selec-

fixed condenser across the primary of this instrument, and approximately a .00025 mfd. fixed condenser across the secondary. Inasmuch as many small fixed condensers vary somewhat, it may be necessary to try several before satisfactory results are obtained. If access can be had to a wave-

meter tuning as high as 30 kc. (10,000 meters) of course one can design his transformer so that it will exactly match the peak on the iron-core transformers which are to work with it. A good intermediate-frequency amplifier will usually give all the amplification necessary with two stages, and it is very doubtful whether one should ever use more than three stages.

THE SECOND DETECTOR AND AUDIO AMPLIFIER

THE second detector usually gives very little trouble in any set. Rather a low value grid leak seems to work best in this

circuit, usually about two to four megohms and, of course, the phone bypass condenser should not be omitted. Here again experiment will show the best value for this condenser. Usually a condenser with a capacity of from .001 mfd. to .006 mfd. will be found most suitable, preference being given to the low values.

A good super-heterodyne will give all the volume that one could desire for headphone use without any audio amplifier, even when receiving distant stations on the loop. For loud-speaker operation one, and possibly two stages of audio frequency amplification may be added. Here again the use of good transformers cannot be over emphasized. If the constructor is willing to pay a high price for one of the new type high ratio audio-frequency transformers now on the market, all well and good; otherwise he will probably obtain the most satisfactory results by not attempting to use a transformer having a ratio of more than 3 or 3½ to 1. Some of the newer transformers mentioned above will amplify in a very satisfactory manner even though they do have ratios of 5 or 6 to 1. Such a transformer cannot, however, be constructed cheaply due to the fact that it requires a heavy core and an exceedingly large number of turns on its secondary. Unless the set is to be used in a large room or hall, one good stage of audio-frequency amplification will usually give enough volume for satisfactory loud-speaker operation. If a second stage is desired, it had best be either of the power type using some such tube as the UV-202 or the Western Electric 216-A, or perhaps,

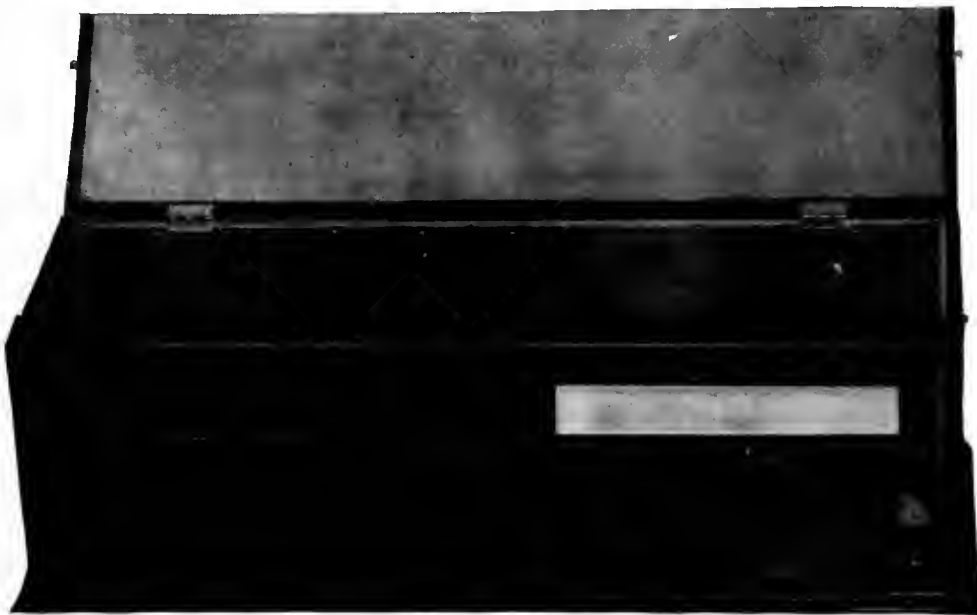

RADIO BROADCAST Photograph

A COPPER LINED CABINET

Shielding will prevent body capacity effects and also prevent the coils, transformers, etc., picking up the transmitted waves thus impairing the efficiency

tivity in tuning that could be desired, especially if the first detector is made regenerative. For those who are interested in experimenting with tuned input and output circuits, the following specifications will be found useful in constructing an air-core transformer having a peak at about 31 kc. (9600 meters); primary, 750 turns No. 30 d. s. c. wire, random wound on a form having a central opening ¾ of an inch in diameter and 1⅝ of an inch wide. Secondary, two 800-turn coils connected in series and wound with d. s. c. wire on the same

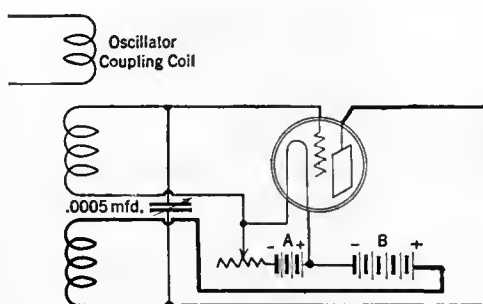

FIG. 2

form as the primary was wound on. The two secondary coils are to be placed one on either side of the primary coil. If these coils are wound on a suitable collapsible form, they can be lightly doped with collodion and made self-supporting, thus doing away with any supporting form. In this way some slight increase in efficiency can be had over coils wound on solid forms. It will be necessary to shunt a .001 mfd.

the push-pull construction which has been quite popular during the last year or two.

The second stage of audio-frequency amplification handles exceedingly heavy currents, especially on local signals, and any ordinary receiving tube will become so overloaded that bad distortion will occur. Some discussion has been raised as to the necessity for a filter before the audio-frequency amplifier to keep the intermediate-frequency currents from entering it. It is doubtful whether such a filter will be found necessary if careful construction work is done. The use of large bypass condensers (.5 to 1.0 mfd.) across both the amplifier and detector sections of the B battery, will aid in keeping these currents out of the audio circuits.

GENERAL CONSIDERATIONS

IF ONE is going to the expense of building a super-heterodyne, the author would by all means advise the use of storage battery tubes, except in those cases where a portable set is desired, or where the charging of storage batteries is a great inconvenience. The B battery current drawn by a super-heterodyne, although it is large, need not be excessive. The author's own set, using nine dv-2 tubes, draws but eight to ten milliamperes of B battery current and from 1 1/2 to 1 3/4 amperes on the A battery side, by actual measurement. If more than twenty milliamperes are drawn in the B battery circuit by a super-heterodyne using

Considerable care must be exercised in the selection of tubes for the intermediate-frequency amplifier, and it may be necessary to try several different arrangements of tubes in the set before a really satisfactory arrangement is found. The operation of the whole set may be ruined by one faulty tube anywhere before the second detector.

A great many times it will be found that the loop does not have much directional effect and that it can very often be built inside a cabinet housing the set with practically no loss in signal strength. This is true with the author's own set, and such a construction does much toward improving the appearance of the set and protecting the loop and its connections from dirt and injury.

A comparison of the results obtained by the author using his set, with those results obtained using other sets in exactly the same location, may be of interest. The set is located in one of the suburbs of Boston. Several years ago a three-tube set, employing the three-circuit tuner, was used in the same place with a three-wire indoor antenna about thirty-five feet long and twenty-five feet high. New York stations could be heard on the loud speaker regularly, and Chicago stations occasionally. About two years ago a five-tube neutrodyne set was installed. This employed three stages

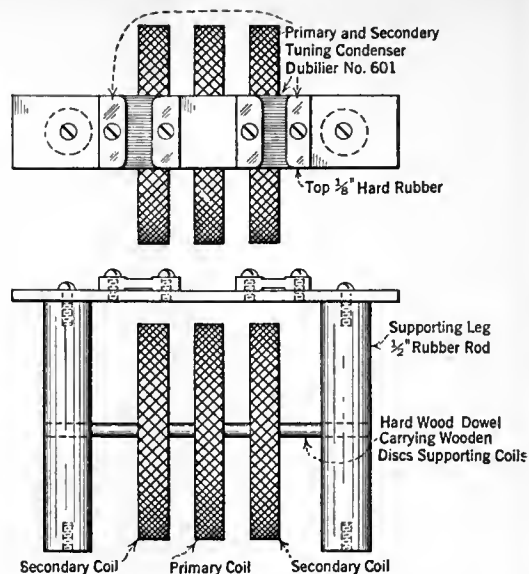

FIG. 3

A sketch of the author's 9600-meter tuned output transformer drawn approximately to scale

push-pull, gives consistent loud speaker operation on Chicago stations and fairly consistent loud speaker operation on Cuba and the Texas stations. London's 2 LO was heard on the loop twice during last year's transatlantic tests, once on the loud speaker.

The author does not feel, however, that the present super-heterodyne, working on its built-in loop, is any more effective as a distance getter than was the previous neutrodyne set working on the thirty-five foot indoor antenna. Of course there is the advantage that the present set has but two tuning controls.

Whether or not the super-heterodyne is enough better than the other good circuits known to-day to justify the extra expense demanded in its construction and operation, is still a debatable question.

In conclusion let it be repeated that it is impossible to overestimate the undesirability of operating the super-heterodyne on an outside antenna. Even when a loop is employed it is possible to interfere with other receivers in the same building. For successful operation the type of receiver depends on the fact that it is a miniature transmitter, and as such, will cause considerable interference if coupled to an outside antenna.

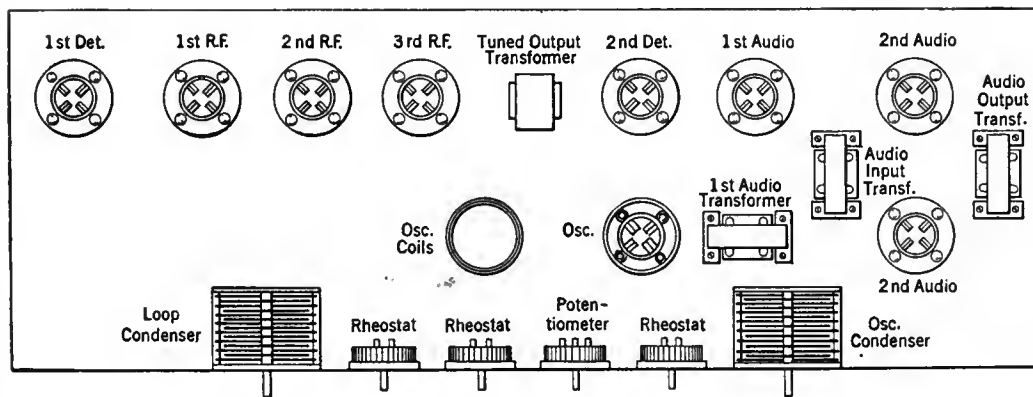

LAYOUT DIAGRAM

Of the essential parts of a nine-tube superheterodyne using two stages of audio, the second stage being push-pull. Note the position of the oscillator tube, coils, and condenser, as far away from the first detector as possible. The long wave transformers are mounted under the three radio frequency tubes feeding into them, and are not shown in this sketch

iron-core transformers, it is probable that there is something wrong somewhere in the set.

Any voltage from 45 to 90 is suitable for use on the intermediate-frequency tubes. For best results, one should not use more than 20 to 30 volts on the detectors.

In order to use as few rheostats as possible, the two detectors may be operated from one rheostat, the three intermediate amplifiers from a second, the oscillator perhaps from a third, while the audio amplifiers may well be run through fixed resistance units rather than from a rheostat.

of neutralized radio-frequency amplification and two stages of audio-frequency amplification, one of the latter being reflexed through one of the radio tubes. Loud speaker operation on the Chicago stations was possible, using the same antenna as outlined above; fairly consistent loud-speaker signals on stations as far south as Cuba and Texas were obtained. The present set, a nine-tube super-heterodyne, using three stages of intermediate-frequency 30-kc. amplification and two stages of audio-frequency amplification, the second stage being

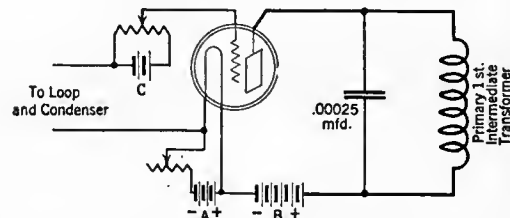

THE C BATTERY CONNECTIONS

On the first detector tube to obtain grid bias. The potentiometer used here must be a high resistance one of about 1800 ohms. The high frequency bypass condenser may be seen directly across the first transformer primary. This is the method of connecting the condenser when regeneration is not used on the first detector

# The Newest Achievements of POWEL CROSLLEY JR.

Industrialist—Pioneer Radio Builder—Master of Mass Production

## Four Entirely New 4- and 5-tube Radio Sets—Also the Crescendon

Never before has Crosley engineering and manufacturing genius been so brilliantly demonstrated as in this group of new Crosley sets.

Here, at prices so low as to be literally revolutionary, are three 5-tube sets and one 4-tube set—entirely new in principle, design, circuit, and appearance—entirely unique in the results they give on distant and local stations—entirely unprecedented in the values they now introduce.

On two of these sets is offered the Crescendon, a new and exclusive Crosley feature—an extra volume control by which average incoming signals can be built up or modified in a manner nothing short of amazing. Introduced on the new 4-29 and 5-38, the Crescendon principle makes its first appearance in the low price field, its use having hitherto been restricted to one set costing several times as much.

Particular emphasis is directed to the new Crosley RFL receiving sets that utilize an entirely new and patented circuit which provides true cascade amplification and closely approaches the theoretical maximum of efficiency per tube. Non-oscillating at any frequency and absolutely non-radiating, the RFL Crosleys are specifically recommended for use in congested areas and for satisfactory performance in the hands of inexperienced operators.

In addition to their truly marvelous selectivity, sensitivity, and purity of tone, these new Crosleys have been given a new order of beauty that cannot help but win the highest admiration.

We do more than urge you to go to the nearest Crosley dealer for a demonstration! We ask you to go prepared for the most startling revelation in radio ever announced in the entire history of the industry—and predict that your expectations will be more than satisfied!

*Crosley manufactures radio receiving sets which are licensed under Armstrong U. S. Patent No. 1,113,149, or under patent applications of Radio Frequency Laboratories, Inc.*



### THE CROSLLEY RADIO CORPORATION, CINCINNATI, OHIO

Owning and Operating WLW first remote control super-power broadcasting station in America



*The Crosley 4-tube—4-29*

in which the Crescendon is equivalent to one or more additional tubes of tuned radio frequency amplification . . . **\$29**



*The Crosley 5-tube—5-38*

All the volume, selectivity, sensitivity and purity of tone available in the best 5-tube set—plus the Crescendon . . . **\$38**



*The Crosley 5-tube—RFL-60*

A set so marvelous in performance that its appearance on the market is bound to create a new standard of comparison . . . **\$60**



*The Crosley 5-tube—RFL-75*

For simplicity and speed in tuning, fidelity of tone, and decorative beauty—it stands unchallenged at twice the price . . . **\$75**

*West of the Rocky Mountains all prices as published are 10% higher*

# CROSLLEY RADIO

B E T T E R . C O S T S L E S S

★ Tested and approved by RADIO BROADCAST ★

ASK . . ANY . . RADIO . . ENGINEER

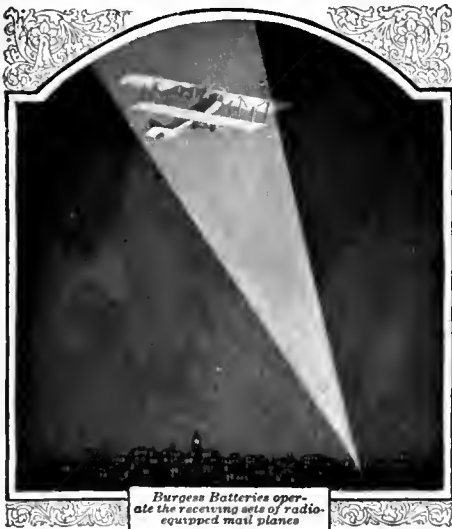

## An every-night adventure of Burgess Radio Batteries

ONE of the reasons why you should always buy Burgess Radio Batteries is that the batteries used by air-mail pilots—battleships—explorers—and the majority of recognized radio engineers—are evolved in the Burgess Laboratories and manufactured in the Burgess factory.

These batteries are identical with the batteries sold by your dealer and thousands of other good dealers everywhere.

**BURGESS BATTERY COMPANY**

GENERAL SALES OFFICE: CHICAGO

Canadian Factories and Offices:  
Niagara Falls and Winnipeg

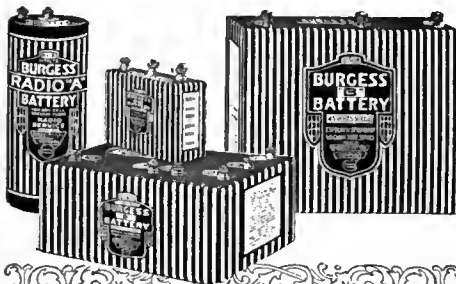

# THE GRID

A Department Devoted to Solving the Problems of our Readers

## QUERIES ANSWERED

1. HOW MAY I OBTAIN A VARIABLE VOLTAGE SUPPLY FROM MY B BATTERY ELIMINATOR FOR THE PLATES OF MY RADIO FREQUENCY AMPLIFIER TUBES?  
R. A. W.—New York City.
2. WILL YOU PUBLISH A SIMPLE CIRCUIT DIAGRAM FOR A LOOP R. F. RECEIVER?  
F. M.—Cape May, New Jersey.
3. WHAT IS THE BEST WAY OF MAKING MY OWN GRID LEAKS FOR EXPERIMENTAL PURPOSES?  
M. L. H.—Bay Shore, Long Island.
4. WHAT ARE THE OPERATING CHARACTERISTICS OF THE NEW TUBES?  
C. A. B.—Little Rock, Arkansas.
5. I HAVE D. C. IN MY HOME. HOW MAY I CHARGE MY STORAGE BATTERY?  
L. P.—New York City.

### SEPARATE R. F. TUBE VOLTAGE FROM B BATTERY ELIMINATORS

MOST B battery eliminators are so constructed that only two distinct voltage values are obtainable, a variable one for the detector tube and a fixed figure for the audio amplifier. When a receiver employing radio frequency amplification is used, it is therefore necessary to apply the same potential to the r.f. tubes as is applied to either the detector or audio plates. It is often advisable to use an intermediate value for the r.f. tubes, however, and this may be accomplished by the addition of a suitable resistance in series with a second lead from the positive high voltage tap of the instrument.

It is a very simple matter to make this addition to the circuit, and it is possible to obtain the variable resistance on the market. In most instances one having an approximately correct

obtain the desired voltage regulation. As an instance; if it is desired to regulate the voltage on the r.f. tubes from 65 to 100 volts, then the maximum resistance value is obtained by applying the formula:

$$R = \frac{E - E_1}{I}$$

Here  $E_1 = 65$ ,  $E = 100$ , and  $I =$  current in amperes per r.f. tube. If no C battery is used in the radio-frequency amplifier then the plate current per tube will be about 5 milliamperes, so where the receiver consists of two r.f. stages the total is 10 milliamperes or .01 amperes. Substituting values for the formula we get—

$$R = \frac{100 - 65}{.01}$$

or

$$R = \frac{35}{.01} = 3500 \text{ ohms}$$

Where a C battery is employed, the current is

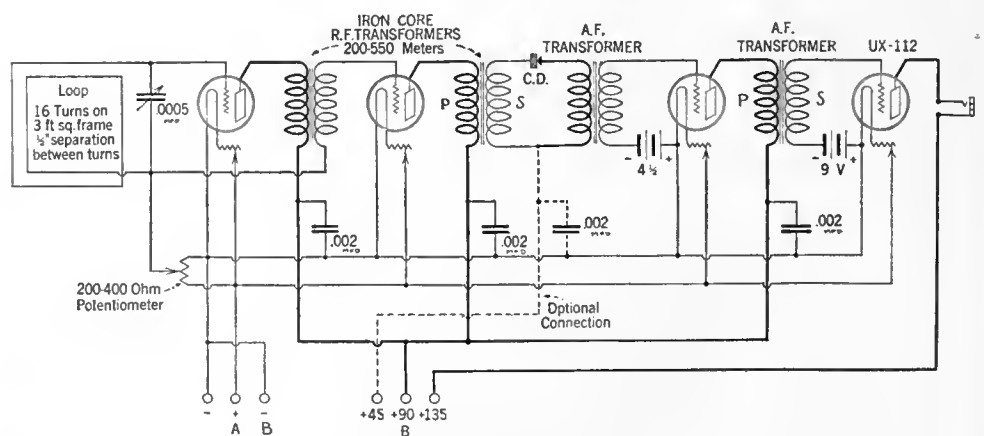

FIG. 2

range will have to be selected. For instance, if it is found that one having a maximum of 4000 ohms is necessary, one rated at 5000 ohms will be just as satisfactory.

The user can very simply determine for himself the value of the resistance necessary to

reduced by a third or a half, and if the experimenter has a milliammeter he can determine in an instant the actual drain per tube by inserting the meter in each tube's plate circuit.

The connections of this additional resistance in the B supply circuit are shown in Fig. 1.

### ONE DIAL LOOP RECEIVER

A VERY simply constructed one dial receiver, employing two stages of untuned radio frequency amplification, a crystal detector, and two stages of audio frequency amplification, is shown in Fig. 2.

To prevent the radio frequency stages from oscillating continuously, a potentiometer of 200 to 400 ohms is shunted across the A battery

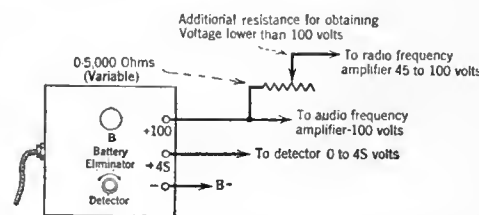

FIG. 1

*Unfailing  
radio power  
from the*  
**LIGHT SOCKET**



*with*

# Balkite Radio Power Units

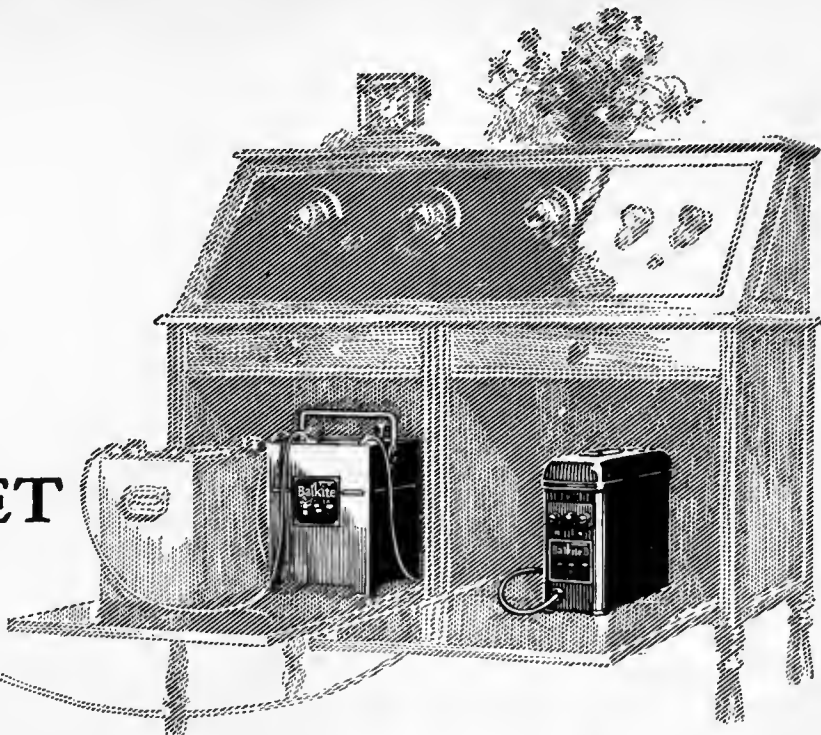

Balkite Radio Power Units give unfailing, uniform current for both circuits from the light socket. One very popular Balkite installation, especially for heavy duty sets where reserve "A" power is required is with the Balkite Battery Charger and Balkite "B." Here the noiseless, high-rate Balkite Battery Charger is ideal. If your battery should be low, you merely turn on the charger and operate the set. Balkite "B" eliminates "B" batteries entirely and supplies plate current from the light socket.

### *Balkite light socket equipment*

Another very popular Balkite installation is with the Balkite Trickle Charger and Balkite "B." The Balkite Trickle Charger converts your "A" battery into an automatic "A" power unit that provides "A" current from the light socket, so that both circuits operate from the lighting circuit. This installation enables you to convert your present receiver into a light socket set.

### *Noiseless — No bulbs — Permanent*

All Balkite Radio Power Units are permanent pieces of equipment, entirely noiseless, have no bulbs, nothing to break, replace or get out of order. Their current consumption is very low. All operate from 110-120 volt AC current, with models for 50, 60 and other cycles. All are tested and listed as standard by the Underwriters' Laboratories.

**[ The Balkite Railway Signal Rectifier is now standard equipment on over 50 leading American and Canadian Railroads ]**

FAN STEEL

# Balkite

★

## Radio Power Units



### **Balkite Trickle Charger**

Converts any 6-volt "A" battery of 30 ampere hours capacity or more into an automatic "A" power unit that furnishes "A" current from the light socket. With 4-volt and smaller 6-volt batteries may be used either as an intermittent charger or a trickle charger. \$10. West of Rockies, \$10.50. In Canada, \$15.

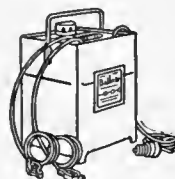

### **Balkite Battery Charger**

The popular rapid charger for 6-volt "A" batteries. Noiseless. Can be used during operation. Special model for 25-40 cycles. \$19.50. West of Rockies, \$20. In Canada, \$27.50.



### **Balkite "B"**

Eliminates "B" batteries and supplies plate current from the light socket. For sets of 6 tubes and less. \$35. In Canada, \$49.50.

### **Balkite "B" II**

Supplies plate current from the light socket. Will serve any standard set. Especially adapted to sets of 6 tubes or more. \$55. In Canada, \$75.

MANUFACTURED BY FANSTEEL PRODUCTS COMPANY, INC., NORTH CHICAGO, ILLINOIS

SOLE LICENSEES IN THE UNITED KINGDOM: MESSRS. RADIO

ACCESSORIES LTD. 9-13 HYTHE RD., WELLESDEN, LONDON, N. W. 10



## Greater Station Spread With 360° Dial

NEW Wade vernier dial, finished in beautiful black lacquer is a vital factor in the Wade tuning efficiency—Spread stations over the entire 360° circumference and gives twice the space between stations for close tuning as rotor plate types of straight line frequency condensers using 180° dials. No more bunching of stations, none of the annoyance of overlapping stations.

By actual test the Wade condenser gives the lowest minimum capacity and wider tuning range. Covers the whole broadcast range and down below 200 meters.

### No Body Capacity Effects

A separately grounded frame insulated from both sets of plates shields the condenser from all body capacity effects—an important feature, exclusively in Wade Condensers.

### WADE TUNING UNIT

Including Condenser and Dial

The Wade Tuning Unit consists of a Wade Condenser geared to a four-inch 360 degree vernier dial of 16 to 1 ratio. Finest possible control with no backlash. Prices below are for the complete unit.

- Capacity .000125 mfd. .... \$6.00
- Capacity .00025 mfd. .... 6.25
- Capacity .00035 mfd. .... 6.35
- Capacity .0005 mfd. .... 6.50

At your dealers, otherwise send purchase price and you will be supplied postpaid.

Jobbers and dealers write for further information and opportunities in your locality.

**The Viking Tool and Machine Company, Inc.**

745-A 65th Street

Brooklyn, N. Y.



leads. The return side of the secondary of the first r.f. amplifying transformer and the lower side of the loop are connected to the central arm of this potentiometer. It is recommended that a power tube, such as the UX-112, be employed in the last audio stage. This will insure quality reproduction providing a C battery of the proper value is employed, to bias its grid. The use of a C battery in the first audio stage will be found helpful also, and should be included, although its value will not be as high as for the second stage.

Any type of loop capable of being tuned to the broadcast band of frequencies is suitable

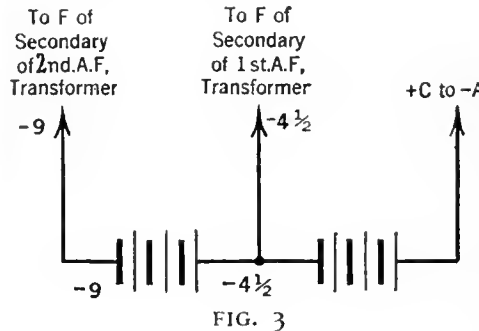

but for those who wish to make their own, it is suggested that a box frame, three feet square and ten inches wide, and having 16 turns of No. 18 bell wire wound thereon, separated 1/2 inch apart, be employed.

Values for the various parts are indicated in Fig. 2 while Fig. 3 shows how two 4 1/2-volt C batteries, connected in series, may be used to furnish grid bias for both audio amplifier stages.

#### MAKING YOUR OWN GRID LEAKS

THE true experimenter always desires to make as much of his own apparatus as is possible. Grid leaks are important in maintaining the proper standard of reception and not always is it possible for the experimenter to secure a grid leak of the value which will produce these results.

With the aid of drawing ink and a business

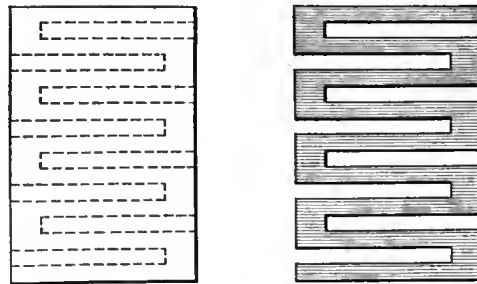

FIG. 4

calling card, it is possible to make grid leaks of various values.

One side of the card is completely covered with the ink and then by cutting into the sides with a pair of scissors as shown in Fig 4, it is possible to vary the value of leak by removing the sections cut into.

Grid leaks of this type should be thoroughly dried before using, as the value of the leak will vary with different degrees of temperature and moisture.

Paper clips make satisfactory connections to the ends of the inked paper.

#### NEW TUBES AND THEIR CHARACTERISTICS

ONLY recently the new line of radio tubes has been added to the fast-growing accumulation of apparatus from which the constructor may make his choice in building high quality receivers. More and more atten-

tion is being centered upon the production of units designed to be employed in receiver installations where quality is the goal.

A BATTERY SUPPLY	FILAMENT TERMINAL VOLTS	B BATTERY (AMPLIFIER)	GRID BIAS	NORMAL PLATE CURRENT
FOR THE UX-112 THE REQUIREMENTS ARE:				
6	5	157.0	10.5	7.9
6	5	135.0	9.0	5.8
6	5	112.5	7.5	2.5
6	5	90.0	6.0	2.4
FOR THE UX-120 THE REQUIREMENTS ARE:				
4.5	3	135	22.5	6.5

The new tubes offer to the constructor the means for operating his receiver at the efficiency at which it should be operated. However, there are certain requirements that must be observed in the use of these tubes.

Those that interest the constructor most are the power tubes, UX-112 for 6-volt source, and the UX-120 for 4 1/2-volt source. Each must be supplied with its correct grid and plate voltage or else there is no advantage in their use. The requirements are shown in the accompanying table which appears at the top of this column.

#### HOW TO CHARGE STORAGE BATTERIES FROM D. C.

THE charging of storage batteries which serve to supply the energy for the filaments of radio tubes is a problem which has engaged the attention of many engineers who are seeking to make this work easy for the man at home.

In many places only alternating current is obtainable for charging purposes and, where this is the case, some rectifying devices must be employed to change the current in the lighting mains from alternating to direct current. Where a simple rectifier is used the resultant rectified current is not purely a constant direct current but is more correctly termed a pulsating direct current.

A glance at A in Fig. 5 shows how this occurs. The alternation or cycle of current in an alternating current line assumes a definite form starting at a zero or neutral line. It then rises to a positive value afterward decreasing to the neutral again. This constitutes a half cycle. Now it continues below the neutral line toward the negative in the same fashion as it went positive. Therefore, it is observed that the cycle consists of two wave forms, one positive, the other negative in potential.

The rectifier is so designed and operated as to exclude the negative half of the alternation, permitting only the positive half to pass. This results in a series of pulsations of a positive nature which, if visible, would look like those shown in B. It is these periodic raps or pulsations which enter the battery on charge, causing a chemical change in the nature of the plates of which the battery is composed, so that it resumes its original charged state.

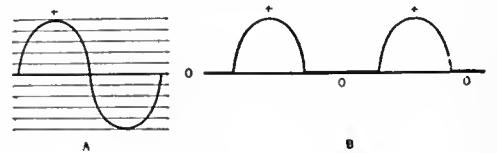

FIG. 5

This chemical change within the battery must be accomplished slowly, that is, at a low ampere-hour rate, otherwise the compound pressed into the plates of the battery will disintegrate and fall to the bottom of the cell, thus causing short-circuits from plate to plate.

Where the charging current is direct current a different procedure must be employed. Here



Perhaps you, too, can cut your "B" battery costs in half. Just follow the chart. It gives you the secret of "B" battery economy.

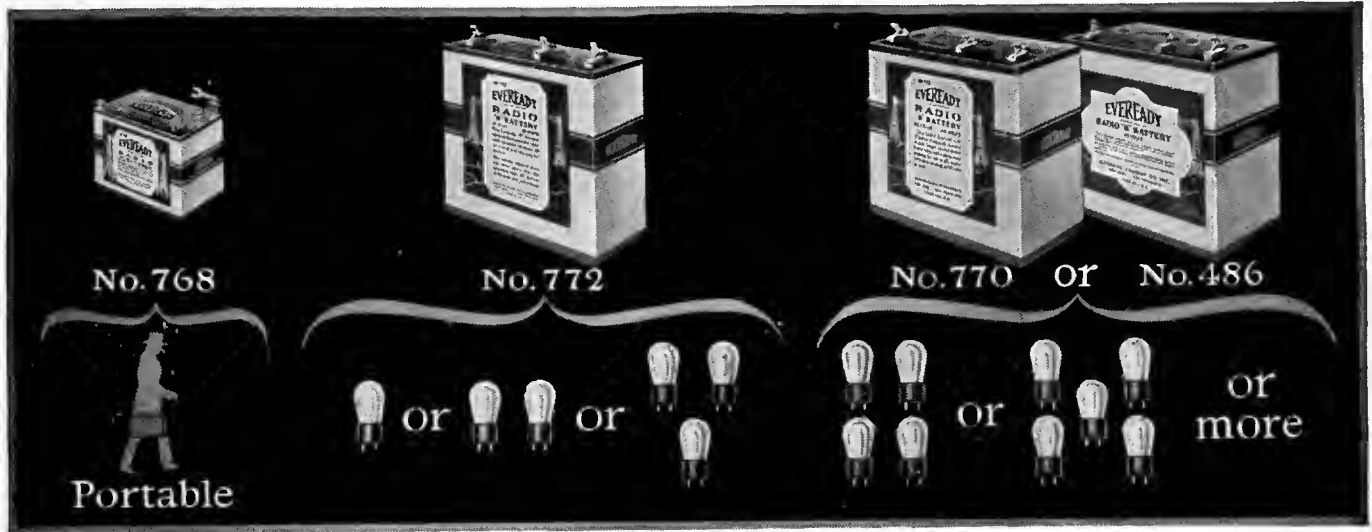

THOUSANDS of people have made the discovery that Eveready "B" Batteries, when used in the proper size and with a "C" battery\*, are the most economical, reliable and satisfactory source of radio current.

On sets of one to three tubes, Eveready "B" Battery No. 772, used with a "C" battery, will last a year or longer, usually longer. On sets of four and five tubes either of the larger Heavy Duty Eveready Batteries No. 770 or No. 486, used with a "C" battery\*, will last eight months or more.

These figures are based on the average use of receivers, which a country-wide survey has shown to be two hours daily throughout the year. If you listen longer, of course, your batteries will have a somewhat

shorter life, and if you listen less, they will last just that much longer.

Here is the secret of "B" battery satisfaction and economy:

*With sets of from 1 to 3 tubes, use Eveready No. 772.*

*With sets of 4 or more tubes, use either of the Heavy Duty Batteries, No. 770, or the even longer-lived Eveready Layerbilt No. 486.*

*Use a "C" battery on all but single tube sets.*

Evereadys give you their remarkable service to the full when they are correctly matched in capacity to the demands made upon them by your receiver. It is wasteful to buy batteries that are too small. Follow the chart.

In addition to the batteries

illustrated, which fit practically all of the receivers in use, we also make a number of other types for special purposes. There is an Eveready Radio Battery for every radio use. To learn more about the entire Eveready line, write for the booklet, "Choosing and Using the Right Radio Batteries," which we will be glad to send you on request. This booklet also tells about the proper battery equipment for use with the new power tubes. There is an Eveready dealer nearby.

Manufactured and guaranteed by  
**NATIONAL CARBON CO., INC.**  
 New York San Francisco  
 Canadian National Carbon Co., Limited  
 Toronto, Ontario

Tuesday night means Eveready Hour  
 —9 P. M., Eastern Standard Time,  
 through the following stations:

- WEAF—New York
- WJAR—Providence
- WEEL—Boston
- WTAG—Worcester
- WPI—Philadelphia
- WGR—Buffalo
- WCAE—Pittsburgh
- WSAT—Cincinnati
- WEAR—Cleveland
- WWJ—Detroit
- WGN—Chicago
- WOC—Davenport
- WCCO { Minneapolis
- { St. Paul

KSD—St. Louis  
 KGO—San Francisco, 8 P. M. Pacific Coast Time

**EVEREADY**  
**Radio Batteries**  
*—they last longer*

\*NOTE: In addition to the increased life which an Eveready "C" Battery gives to your "B" batteries, it will add a quality of reception unobtainable without it.

*“and even the distant stations now come in loud and clear”*

## A UX Power Tube will increase volume and clarity in YOUR set, too!

### REWIRING UNNECESSARY

**NOTE:** The UX-120 tube has been designed to increase volume and clarity in all dry battery sets. The UX-112 tube has been designed to increase volume and clarity in storage battery sets. To make it easy for you to secure the great benefits of the UX tubes without rewiring your set, a complete line of Na-Ald Adapters and Connectoralds have been manufactured.



No. 920 Connectorald

Months of service have proved their efficiency. Below are given three very efficient and easily made applications of the new power tubes. For complete details covering all possible applications of the new tubes mail coupon at bottom of ad.

#### How to improve sets equipped with UV-199 tubes

To increase volume and clarity in sets using UV-199 tubes, use the UX-120 tube in the last stage. Easily fitted to the UV-199 socket with a Na-Ald No. 920 Connectorald which also provides cables for attaching necessary extra 45 volts B battery and 22½ volts C battery required for the UX tube. Price, \$1.25.

#### How to switch to dry batteries without sacrificing volume or quality

The combination of a UX-120 tube for the last stage with UX-199 tubes in the other sockets provides, with dry cells, results previously obtained only with storage batteries. Fit UX-120 tube to the UV-201A Socket with Na-Ald Connectorald No. 120. Cables provided for attaching extra B and C batteries. Fit UX-199 tubes in all other sockets with Na-Ald No. 419-X Adapters. Price, No. 120 Connectorald, \$1.25; No. 419-X Adapter, 35c.



No. 120 Connectorald

#### How to improve storage battery sets

Volume and clarity can be increased in storage battery sets by using the UX-112 tube in the last stage. Easily fitted to the UV-201A socket by means of the Na-Ald No. 112 Connectorald which provides cables for attaching necessary extra B and C batteries. Price, \$1.25. Mail coupon below for complete adapter information covering use of new tubes in all sets.



No. 419-X Adapter

**ALDEN MANUFACTURING COMPANY**  
Dept. B 16 Springfield, Mass.  
All Na-Ald Sockets, Dials and Adapters are protected by patents. Many patents Pending

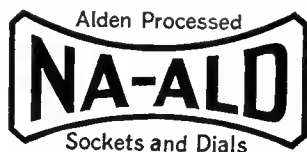

ALDEN MFG. CO., Dept. B16, Springfield, Mass.  
Please send me complete information on how to increase volume and clarity in any set by the use of the new tubes.

Name.....  
Address.....  
City.....State.....

the current is already direct so there is no need to rectify. However, it usually is higher in voltage than is desirable, and if a battery were connected to it directly, the low resistance of the battery would cause high current to be passed through it. This is equivalent to a rapid high charge which, as explained previously, causes disintegration of the plates of which the battery is composed. Therefore, when employing d.c., it behooves us to regulate the current flowing through the battery on charge so that this breaking up does not occur. If the resistance of the battery could be increased, then less current would flow in the circuit. Of course, it's not possible to increase the battery resistance, but an external resistance can be added to the circuit which will accomplish the desired result.

By the use of a simple formula, it is possible to calculate the resistance necessary to charge the battery at a predetermined rate. In this formula,  $W = I \times E$ , the E represents the d.c. line voltage, usually 110 volts, and I represents the

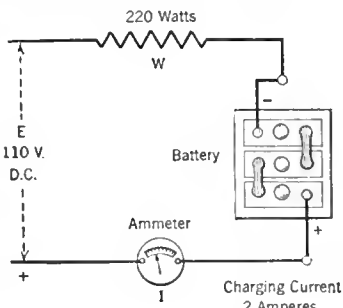

FIG. 7

rate of charge in amperes at which we wish to charge the battery. Let us suppose that we wish this rate to be 2 amperes. Then  $I = 2$ , and W represents watts, the unknown. If we could determine this value of W, then we could make use of the many home electric appliances, such as electric light bulbs, toasters, irons, heaters, etc., to charge the battery. Usually the manufacturers of such devices have a nameplate fastened to the apparatus which, among other things, tells its line voltage and watts value.

By applying the formula we find that  $W = 2 \times 110 = 220$  watts. From this we see that, if in the charging circuit we employ a device rated at 220 watts, the battery will be charged at the rate of 2 amperes. Batteries are rated in capacity, that is, their ampere-hour capacity. Theoretically, if a 100 ampere-hour battery be discharged at the rate of 2 amperes, it will last for 50 hours of use. In recharging this battery to its former state of usefulness, it is necessary to charge it for 50 hours at 2 amperes or 25 hours at 4 amperes or 100 hours at 1 ampere, etc.

Coming back to the use of formulas, if we wished to determine the actual resistance of the device necessary to charge the battery at 2 amperes, the formula  $R = \frac{E}{I}$  would be employed. By substituting values we see that  $R = \frac{110}{2} = 55$  ohms. To check back our first formula,  $W = I \times E$ , there is another one,  $W = I^2 \times R$ , which will prove that the resistance of a 220 watt device is 55 ohms when used on a 110 volt d.c. line.

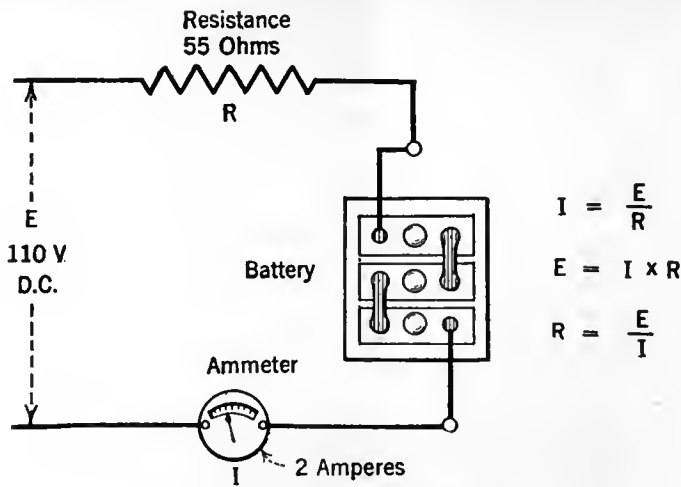

FIG. 6

Substituting values,  $W = 2^2 \times 55$ , or  $W = 4 \times 55 = 220$  watts.

Often the experimenter will know his line voltage and the wattage of a piece of electric apparatus. By using the formulas above and transposing symbols, it is possible to determine the rate of charge of a battery circuit when that apparatus is included in the circuit as part of the charging medium. The variations or transpositions of the first formula  $W = I \times E$  are,  $E = \frac{W}{I}$  and  $I = \frac{W}{E}$ . It is the last one that we can apply in the last case described,  $I = \frac{W}{E}$  or  $I = \frac{220}{110} = 2$  amperes. If  $W = 600$ , then  $I = \frac{600}{110} = 5.45$  amperes. These explanations will become more apparent from an observation of the circuits in Figs. 6. and 7.

In a great many homes there is employed a local lighting system, such as the farm lighting affairs. They consist mainly of a bank of storage batteries totalling 32 volts, with a direct current generator, the latter being used to charge them. Often it is not practicable to move the radic storage battery to the location of the generator and batteries, and it is more convenient to charge the battery from a light outlet. By inserting a resistance in series with the 32-volt line, the 6-volt battery may easily be charged. Applying the above formula to determine the resistance necessary to charge at the rate of 2 amperes  $R = \frac{E}{I}$  or,  $R = \frac{32}{2} = 16$  ohms. Where the value of a resistance is known, say 8 ohms, and it is desired to determine the rate of charge when using that resistance, then  $I = \frac{E}{R}$ , or  $I = \frac{32}{8} = 4$  amperes.

### GRID INQUIRY BLANK

Editor, The Grid  
RADIO BROADCAST  
Garden City, New York

DEAR SIR:

Please give me the fullest information on the attached questions. I enclose a stamped envelope.

I am a subscriber to RADIO BROADCAST and therefore will receive answers to my queries free of charge.

I am not a subscriber and enclose \$1 to cover cost of answers.

NAME.....

ADDRESS.....

G. M.



Model R Receiver:  
Rauland-Lyric-  
equipped. Price  
\$90 (East of the  
Rocky Mountains)

## Beauty and Permanence

### Listeners Marvel—

at the wealth of enjoyment awaiting but a touch of the fingers.

### Women Are Delighted—

with the tasteful stateliness of the Model R cabinet, as much as with the neatness of its battery accommodations.

### Engineers Voice Approval—

of the rigid spot-welded steel chassis, protecting from damage every part of a set that stands as a notable example of the *completely manufactured* rather than the merely *assembled* radio receiver.

### Service Men Commend—

the thoroughness with which every part has been made proof against the interruption of its service, so far as human ingenuity can devise.

### Dealers Are Enthusiastic—

over the excitement created everywhere by this unique receiver and the uniform satisfaction felt by its users.

### Buy "Solid Value" in Your Radio

The leading wholesaler of radio apparatus in your community has probably been, for years, an ALL-AMERICAN Authorized Distributor. ALL-AMERICAN Guaranteed Radio Products are being shown everywhere by responsible and reliable dealers.

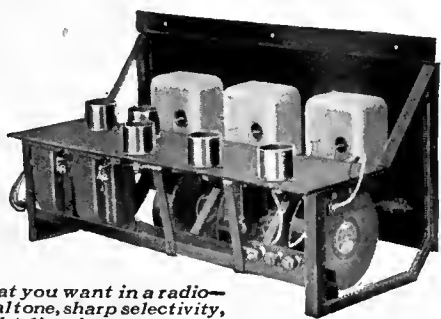
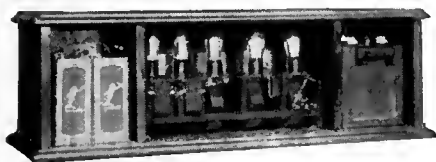

All that you want in a radio—  
natural tone, sharp selectivity,  
straight-line-frequency tuning  
(360°) unaffected by position  
of the fingers, extreme  
sensitiveness, permanence.

ALL-AMERICAN RADIO CORPORATION, E. N. Rauland, Pres., 4213 Belmont Ave., Chicago, U. S. A.



OWNING AND OPERATING STATION WENR—266 METERS

# ALL-AMERICAN

Pioneers in the Radio Industry

C

---TEAR OUT---

Radio Institute of America  
328 Broadway, New York City

Please send me full information about your Home Study Course of radio instruction.

I am interested in the complete course, including code instruction, which qualifies for the U. S. Gov't Commercial or Amateur Radio License.

I am interested in the technical course for radio dealers, jobbers and salesmen.

Name .....

Address .....

# A Shortage of Trained Radio Men!

We can't supply trained radio operators to the shipping companies fast enough! Atlantic, Pacific—Gulf and Lakes—our graduates are sought everywhere.

You can't get better radio training than that offered by Radio Institute of America. Courses planned and supervised by RCA secure you your 1st Class Commercial Radio Operator's License. And an immediate position awaits every graduate.

Moreover you can study at home in spare time.

The coupon will bring you complete information.

## RADIO INSTITUTE OF AMERICA

Formerly Marconi Institute  
Established in 1909

328 Broadway, New York City

# "NOW, I HAVE FOUND . . ."

## A Department for the Exchange of Ideas and Suggestions of Value to the Radio Constructor and Operator

CONTRIBUTIONS to this department are welcome and those used will be paid for at the usual rates, that is, from two to ten dollars each. A prize of twenty-five dollars is given for the best idea used during each three-month period. The prizewinner for the last period was announced in the February RADIO BROADCAST. Manuscripts intended for this department should not exceed about three hundred words in length, and should be typewritten. Little consideration can be given to manuscripts not typewritten. Envelopes should be addressed to this department, RADIO BROADCAST, Garden City, New York.

### HOW TO MAKE BALLOON COILS

BALLOON coils are often seen in many of the latest circuits, but no instructions are given for making them, thus depriving the experimenter of most of the real pleasure of building his own set.

They can be easily made, however. First of all secure a round stick about an inch in diameter and ten inches long, for a winding form. When using one coil within a larger coil (primary and secondary), one form will need to be larger by about a quarter inch, or more, in diameter. Saw a slot about seven inches long in the form and make a wedge as shown in A, Fig. 1, to hold it open while winding the coil. Wrap this form with paper to prevent the insulation of the wire sticking to it when the cement is applied. A tack is employed to hold the paper and is left protruding from the wood so that the beginning of the wire may be fastened to it when the next procedure, that of winding the coil, is started. A second tack is used to hold the other end of the coil when the latter has been completely wound. The size of wire and number of turns can be taken from a manufactured coil, or found by trial. To hold the wires together while bending the coil around the core, the use of collodion, or better still, a solution of acetone and celluloid, is recommended. When thoroughly dry, the coil can be taken off by removing the wedge and closing the slot. A round piece of wood will do for a core for a small coil, or a piece of bakelite tubing for a larger one. Make the core any convenient length. The diameter of the core may be found by cutting a strip of paper the length of the winding and making the core of such size that the paper will not quite meet. Remove the paper from outside of coil and place on the core as shown in B, Fig. 1. A waxed thread should be run through to secure the coil to the core; then carefully

bend the coil around the core and secure with the thread. Space the free coils as evenly as the job requires. A thread around the core on the outside of the coil as shown in C, will help to hold the individual turns steady. When these coils are to be used one inside the other, secure the larger coil to the core but do not space the wires at the joint. The small coil can be slipped in the larger one. A narrow strip of paper is used to space the coils as shown in section in C. Now secure the smaller coil with thread and space the coils as desired.

JOHN L. LEE,  
Washington, D. C.

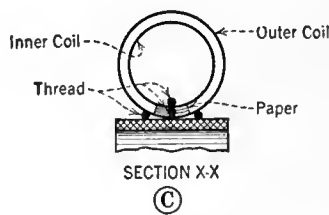
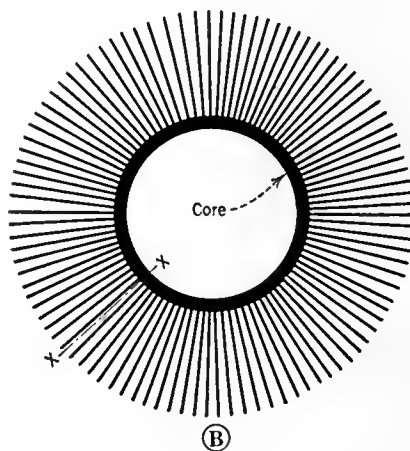
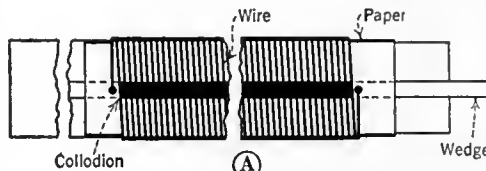

FIG. 1

### A GOOD AUDIO BYPASS METHOD

FROM a constructor's point of view may I register a point in connection with Mr. Milten's power amplifier as published in the November, 1925, RADIO BROADCAST. I have reference to the use of a resistance as a means of securing the negative grid bias, as is best illustrated in his Fig. 9.

Let us suppose that a milliammeter in the plate circuit of the power tube registers 10 milliamperes, and let us suppose that the audio frequency fluctuations range from 5 milliamperes to 15 milliamperes. The voltage drop across R3 is proportional to the value of the plate current, since the entire plate current must pass through R3 in order to reach the filament.

The voltage drop, therefore, not only varies in the ratio of 1:3 during the audio frequency cycle but unfortunately this variation is—as one might say—"180 degrees out of phase" with the grid current fluctuations. When the grid has reached its most positive potential, the negative grid bias is then at a maximum, because the plate current is at a maximum, and when the grid has reached its most negative potential, the negative grid bias is then at a minimum because the plate current is at a minimum. The effect, therefore, is to reduce the amplitude of the grid circuit fluctuations, and con-

# The *New* NATIONAL EQUICYCLE Condenser

The latest development in straight line frequency control as applied to NATIONAL Condenser design. Increases range of rotation from 180° to 270°, permitting more precise adjustment and sharper separation of stations, and accomplishes this WITHOUT GEARS, CAMS, OR LEVERS.

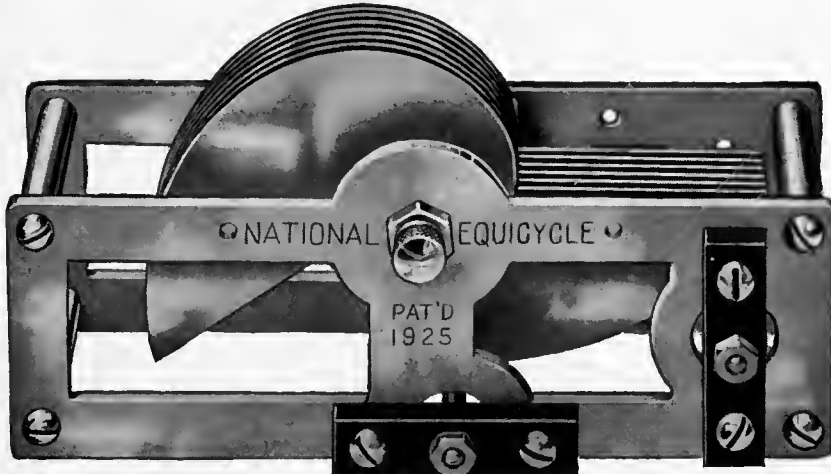

(Patented February 10, 1925)



Type BDI-A  
NATIONAL TUNING UNIT

Embodying the genuine Browning-Drake Inductance Coil and the NATIONAL Condenser

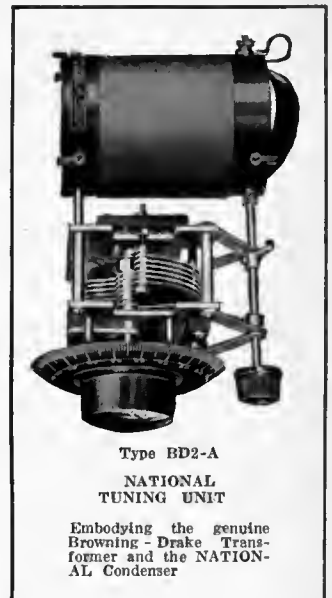

Type BD2-A  
NATIONAL TUNING UNIT

Embodying the genuine Browning-Drake Transformer and the NATIONAL Condenser

*It changes a mob into an orderly procession*

*and lengthens the line of march!*

Tests Conducted at Harvard University, by Prof. Field, give characteristics of the new Equicycle Condenser as indicated by the following graph:

—The novel shape of the plates spaces the station groups at equal intervals of 10 kilocycles (as specified by the U. S. Department of Commerce) in a true straight frequency line.

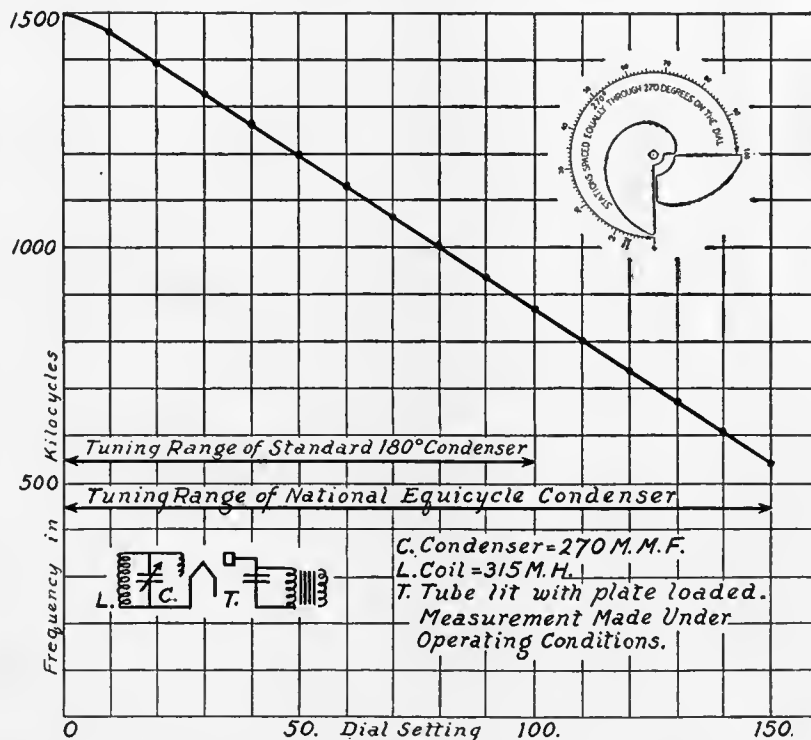

—The same electrical efficiency and mechanical ruggedness that have always characterized NATIONAL DX Condensers have been embodied in the *new* NATIONAL EQUICYCLE Condenser.



Type B  
NATIONAL VELVET VERNIER DIAL

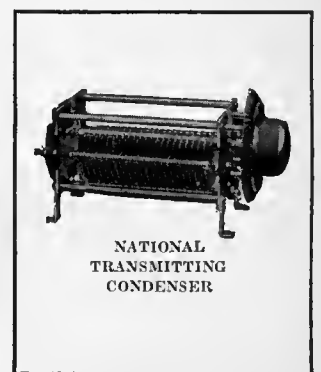

NATIONAL TRANSMITTING CONDENSER

Get the Genuine. Insist upon NATIONAL COMPANY'S RADIO Products. Your dealer appreciates your patronage and will gladly get them for you.

Write for Bulletin III-RB

**NATIONAL COMPANY, Inc.**

W. A. READY, PRESIDENT

110 Brookline St.

Cambridge, Mass.

# Protects



## against leaks and losses

THE UTMOST possible protection against leaks and losses in the circuit is afforded by Radion—*The Supreme Insulation*.

Radion Panels reduce surface leakage and dielectric absorption to a minimum. Their beautiful surface finish adds to the attractiveness of any set. Radion Dials match their beauty of finish and help to get close tuning. Radion Sockets reduce capacity effects.

Radio dealers have the complete line of Radion low-loss parts. Manufacturers will find it to their interest to write us for prices on moulded parts. Send for catalog.

FREE Booklet, "Building Your Own Set" mailed on request.

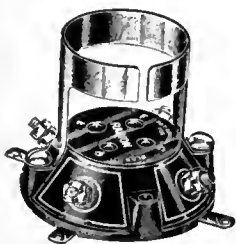

No. 2 Radion Socket for new UX tubes, with collar adapter for old type tubes. No. 4 same as No. 2, without collar adapter, for new UX tubes exclusively

AMERICAN HARD RUBBER COMPANY

Dept. C-15  
11 Mercer St.  
New York City

Chicago Office:  
Conway Building

Pacific Coast Agent:  
Goodyear Rubber Co.  
San Francisco  
Portland



# RADION

*The Supreme Insulation*

Made to order exclusively for radio purposes

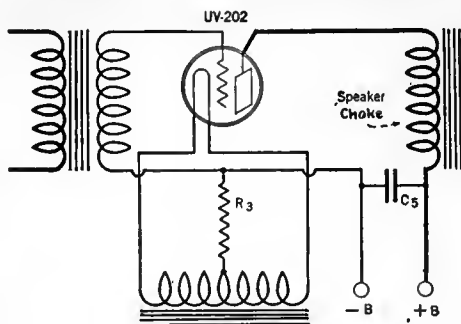

FIG. 2

sequently the amplification. It amounts in fact to a reversed feedback.

The audio frequency bypass condenser, C5, of his Fig. 4, if transferred to Fig. 9 for simplicity of illustration, would appear as in accompanying Fig. 2. In this position C5 does not overcome the objections noted as the entire plate current (both d.c. and a.c. components) must still pass through R3.

I wish to suggest that C5 be placed as in Fig. 3 shown herewith. It is evident that in this position only the average plate current (i.e. the d.c. component) will pass through R3, and a fairly constant grid bias will be obtained throughout the entire audio frequency cycle which will neither add to, nor subtract from, the grid current fluctuations. The a.c. component of the

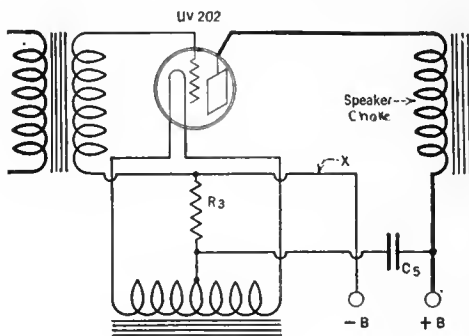

FIG. 3

plate current is now supplied by C5, or "bypassed" if one wishes to think of it in that way.

With the change in position of C5, if now a 20-henry 25-milliamper choke is introduced at X, the combination becomes as good as a dry cell C battery.

JEROME KIDDER, M.D.  
Salina, Kansas.

### HOW TO OBTAIN IMPROVED LOUD SPEAKER REPRODUCTION

THE ideal radio set of to-day is, no doubt, the one constructed with a view of securing the highest possible acoustic perfection of reproduction. Sources of distortion in a multi-tube set are galore, and it takes expert knowledge to build one that can be depended upon to bring in the favorite broadcast programs day after day with an unflinching quality of reproduction.

Every component that goes to make up your receiver installation may in a way, be considered as a distortion device. Let us consider the present day loud speakers, ignoring entirely for the moment all distortion that may be due to resonance and similar phenomena. Those built along electro-magnetic lines employ the ordinary

telephone type diaphragm and an electro-magnet. On these speakers the magnetic stress placed upon the diaphragm by the non-modulated component of the plate current is the cause of a certain drag or excessive inertia that is productive of distortion.

On electro-dynamic loud speakers, distortion is partially due to the great load that the low impedance moving coils place upon the tube with the output of which they are connected in series.

Any overloaded loud speaker will produce distorted reproduction.

To improve the quality of reproduction by improving the operation of the loud speaker used in conjunction with a set,

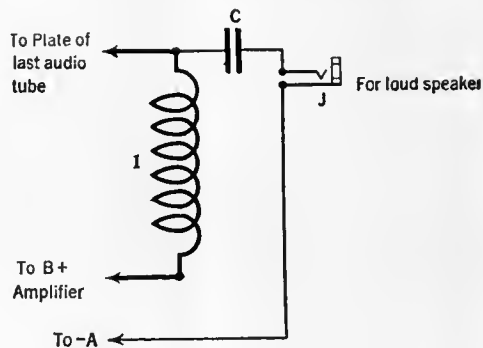

FIG. 4

it is generally recommended to employ some sort of a shunt plate feed for the loud speaker in such a manner that only the modulated component of the plate current be permitted to flow through the loud speaker coil windings.

Fig. 4 shows the conventional arrangement of such a plate shunt feed, where I is usually the secondary of an audio transformer or an impedance of similar characteristics, C a 1-to 4-mfd. blocking condenser, and J an open circuit output jack.

The writer has found that practically identical acoustical improvement can be had by an arrangement as shown in Fig. 5, where R is a grid leak of approximately 50,000 ohms, C a 1- to 2-mfd. condenser, and J the output jack.

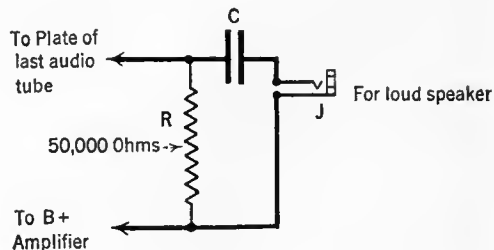

FIG. 5

This arrangement was found quite as effective in reducing loud speaker distortion as is the one shown in Fig. 4. It has a tendency to stabilize the audio amplifying system which is especially apparent when high plate voltages are employed.

It can be built into any set as it takes up very little space, and it does not cost nearly as much as the impedance shunt-plate feed that is the more commonly used.

BORIS S. NAIMARK,  
New York City.

### A LOW LOSS COIL

THE following method describes the making of a low loss solenoid coil which is quite rigid and can be removed with ease from the coil form.

# C O I L S

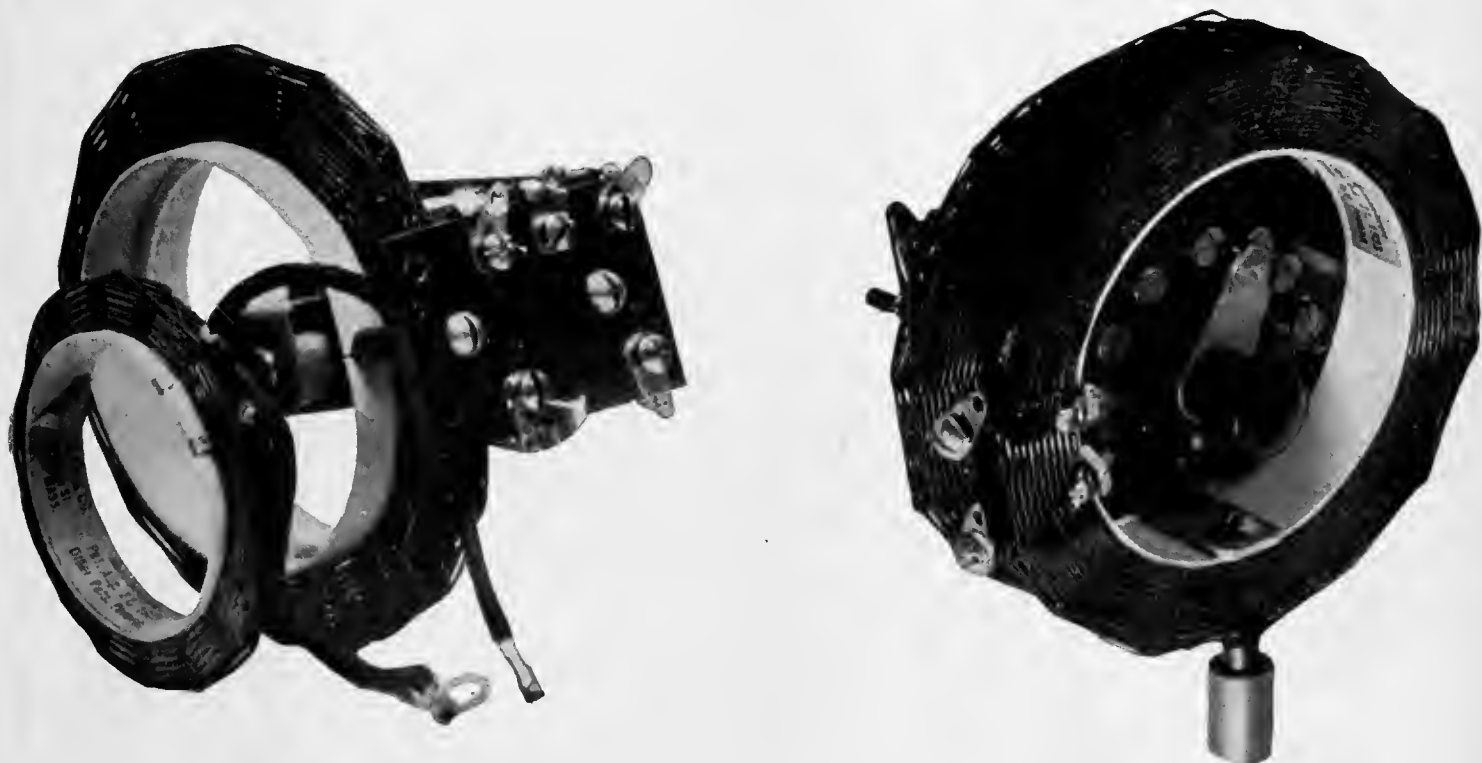

by S I C K L E S

*developed exclusively for the Aristocrat*

THE F. W. Sickles Co. felt strongly that a receiver so advanced in design as the "Aristocrat" deserved coils just as advanced in order to give to the home constructor the inherent benefits of this receiver.

As a consequence Mr. Sickles, who is the developer of the proved "Diamond Weave" principle in coils and who is chief engineer of the F. W. Sickles Co., set to work. The result of his engineering ability backed by thorough-going and practical research, is being enthusiastically welcomed by laboratories everywhere in America. The "Aristocrat" Coil by Sickles is based upon scientific facts, not wishes nor fancies. And these facts were determined by an exhaustive and conclusive series of tests upon highly sensitive and calibrated electrical instruments.

The "Aristocrat" Coil is unquestionably the best coil ever produced by Sickles.

*Write for Radio Broadcast's Five Foot Diagrams.*



## THE F. W. SICKLES CO.

132 Union Street, Springfield, Mass.

★ Tested and approved by RADIO BROADCAST ★

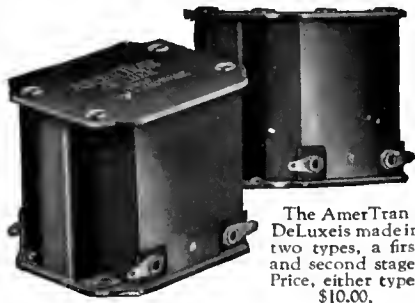

The AmerTran DeLux is made in two types, a first and second stage, Price, either type, \$10.00.

**A New Standard of Excellence in Audio Amplification**

The realism of this new audio transformer is outstanding. Realism of this kind results from the uniform amplification of the fundamental tones of the lower register. The AmerTran DeLux makes possible the natural reproduction of not only the Overtones, but all of the transmitted Fundamental tones.



AmerTran Power Transformer type PF-45, Price \$15.00, type PF-52, Price \$18.00.

The AmerChoke type 854 is a choke coil or impedance of general utility. Price \$6.00.



**A Good Audio Amplifier**

Requires enough plate and grid bias voltage on its tubes to prevent them from being overloaded by the signal voltage.

The AmerTran PF-45 or PF-52 with the half wave high voltage rectifying tubes now available and suitable condensers and resistances—together with three AmerChokes Type 854 will furnish these proper voltages. This combination will give real quality loudspeaker volume. AmerTran Power Transformers also supply A. C. filament current for the last audio tube.



AmerTran Audio Transformers type AF6 (turn Ratio 5) and AF7 (turn ratio 3 1/2) are the leaders in their class. Price, either type, \$5.00.

Write for booklet describing these and other AmerTran Products—with recommendations on their use. It's free on request. All prices are F. O. B. Newark, N. J.

**AMERICAN TRANSFORMER CO.**  
178 Emmet Street, Newark, N. J.

"Transformer builders for over twenty-five years"  
Sold Only at Authorized AmerTran Dealers.

To make the coil form, a wooden block is turned down to a hollow cylinder 2 1/2 inches in diameter and 4 1/2 inches long. See Fig. 6. Then two plugs and two rings are made, one ring and plug for each end of the tube. The diagram shows the constructional data for these. Now two grooves are cut lengthwise on opposite sides of the tube, and a saw cut is made halfway between the grooves on one side. This completes the coil form.

The four bakelite strips, shown in the illustration, are heated until they can be slightly curved, as shown in Fig. 7, and are then allowed to cool. By curving the strips the middle turns of the coil are

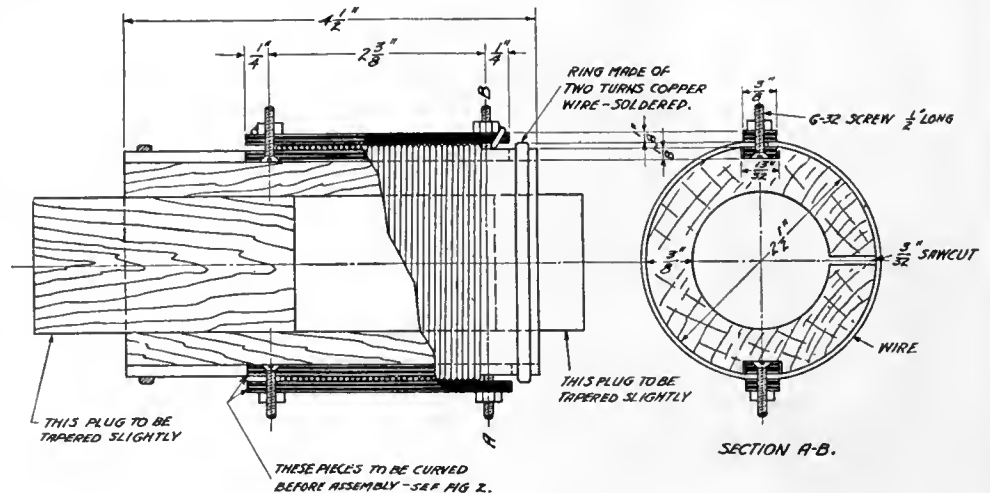

FIG. 6

held fast. The strips are, of course, equal in width to the grooves mentioned above.

Before starting to wind the coil, the two copper-wire rings are put on the form ends and the plugs inserted. Then two of the bakelite strips, with their screws, are placed in the grooves and the curve taken out by binding with string at the middle. The beginning of the wire is bent around one of the screws, which are used for terminal posts, and the winding proceeded with in the usual manner, care being taken to keep the bakelite pieces straight. When finished, bend the wire around the other screw and then fasten down the other two bakelite strips on top of the wire. A little binder can be used to cement the wire to the strips.

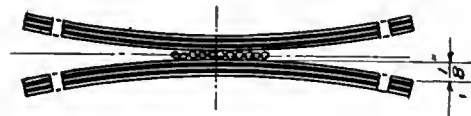

FIG. 7

To slip the coil off, remove plugs and rings and compress the tube.

The experimenter can, by lengthening the bakelite strips and using the same size wire, wind a primary coil at one end of the tube. If smaller wire is used, the outside strips will have to be in two pieces. Also a fixed or movable tickler could be mounted at the other end of the coil.

EVERETT FREELAND,  
Dowagiac, Michigan.

**ONE USE FOR A BYPASS CONDENSER**

IT IS noticeable that in a large number of radio receivers, commercial or home made, the quality of tone is not as good as it should be. In some receivers there is a distinct hiss or a high shrill whistle which comes in continuously with the music or speech. This whistle or hiss is caused by some slight feedback between the tubes, and seems to indicate that there is some oscillation in the audio frequency end which should not be there. To the critical listener this is very objectionable. It may often be effectively stopped, without

affecting the volume of the receiver, by placing a small mica type bypass condenser in the proper place. The condenser should be placed across the plate and plus filament of the last, or in other words, the output tube. Its value should not be less than .005 mfd. but it may be found on trial that

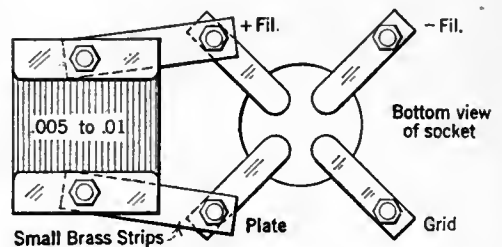

FIG. 8

this should be increased to .01 mfd. A convenient way of mounting the condenser is given in the sketch Fig. 8, which shows the underneath part of the socket and contact springs. A small brass strip about one inch long, with a hole near each end, can be bolted direct to the condenser and to the bolt holding the socket spring. This idea was tried out on a manufactured set of the lower priced kind, and the results were so much improved that such a condenser is being placed on every set of this type that is sold. Placing a condenser across the speaker posts of the receiver was not found to produce the same results as the volume was reduced to some extent, and the tone changed.

K. B. HUMPHREY,  
Brooklyn, New York.



# CARDWELL CONDENSERS

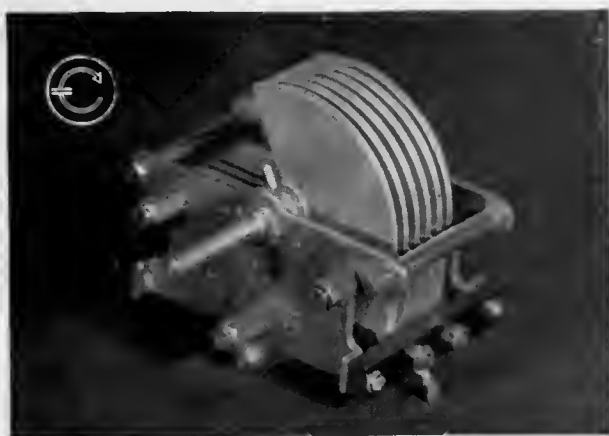

MR. ARTHUR H. LYNCH approved the new Type E taper plate Cardwell as the ideal for use in the "Aristocrat" and other receivers as soon as he saw and tested it.

The new taper plate Type E Cardwell is the logical answer to the demand for a straight frequency tuning curve. Semi-circular plates, far heavier than ever used before, assure permanent calibration, and it will mount entirely behind a four-inch dial. Its depth back of the panel is less than three inches.

The price for the .0005 mfd. size is \$5.00. Other sizes are priced proportionately.



Write for illustrated catalogue  
If your dealer can't supply you, order  
direct from us

The Allen D. Cardwell Mfg. Corp.  
81 Prospect Street Brooklyn, N. Y.



"THE STANDARD OF COMPARISON"

★ Tested and approved by RADIO BROADCAST ★



## ARBORPHONE A New Conception of Good Radio

**N**O MATTER what experience you have had with radio you've a new thrill coming when you listen to Arborphone performance the first time.

Clear reception—even on D X work—is the outstanding quality that endears Arborphone to thousands of owners all over this country. Your Arborphone makes a radio concert something to enjoy with unmarred enthusiasm.

Mother, sister or any member of the family can get plenty of stations on the Arborphone. An expert isn't required to operate this remarkably simplified receiver. Another point—this artistic set is incased in a gracefully designed cabinet, a masterpiece of the woodworker's art.

By all means buy no set before trying out the Arborphone at your dealer's. No value in radio to equal it. Let us send you a copy of our new and interesting radio book.

\$55.00

### Dealers

The sales plan back of this wonderful set assures you a splendid year 'round business. Ask for details—by mail or wire.

\$60.00 in Rocky Mt. and Pacific Coast States.

**MACHINE SPECIALTY CO.**  
321 S. Main St. Ann Arbor, Michigan  
"All you could Ask of a Radio"

RADIO FANS, a one-year's subscription to Radio Broadcast will cost you four dollars, two years six dollars. Consider this expenditure as being a necessary investment on your part for the future development of your own knowledge of Radio.

**Big FREE RADIO**  
**Catalog & Guide**  
PARTS, HOOK-UPS, SETS and KITS  
Send now for this valuable FREE book. Full of advanced hook-ups, parts and kits. A real guide. Shows factory built sets and the new ideas in radio. Send at once. No charge. No obligation. Please include name of radio fan.

**BARAWIK CO.**  
102-109 S. Canal St., Chicago

# A New Way to Make Money in Radio

As Long as New Apartment Houses Are Being Erected, There Will Be Plenty of Opportunity for the Go-Ahead Man

By D. C. WILKERSON

**A**S WITH the swing of the pendulum, the first impressions which labeled radio with the yellow-golden streak as a bonanza for quick wealth, seem to have changed of late.

Hundreds of fly-by-night radio enterprises are going permanently out of business, and perhaps their disgusted proprietors have spread the story that "radio is a lemon." At any rate, although many attractions are offered to young men to take up radio and kindred subjects by the large corporations, most of whom spend real money to train these neophytes, the 1925 crop of college graduates has not leaped into the arms of these welcoming agencies.

Regardless of false impressions blabbed about

nections inside? You can bet your new loud speaker they would.

Now then, who has enough initiative to organize and broach the proposition of making such installations for the building operations company? It would not require much investment in the way of tools and equipment, while copper wire, insulators, screws, spreaders, masts, and the like, can be obtained anywhere. You could make a deal with your local hardware store to supply you at a discount.

Armed with a ladder, some roof "stickers," and some gumption, a couple of bright active fellows could "clean up" in the home town on a job like this. Old clothes, a flock of screw drivers, and a smile or two, would make valuable adjuncts.

Why not try it some of you fans who want to capitalize your hard-earned knowledge of radio?

Again, another market for your knowledge presents itself. It is becoming quite the thing for multiple installations to be rigged up for hotels and apartment houses. Here is a field.

Some jack plates for wall plugs, wiring connecting to a central distribution point where the elevator operator, or telephone girl, keeps tuned-in to some program or other, is not a difficult job.

Inexpensive loud speakers, with plug in each suite, complete the panorama. Some of the finest hotels and apartment houses in the country are being built with these radio conveniences installed.

The work must be done by somebody, and it might as well be you.

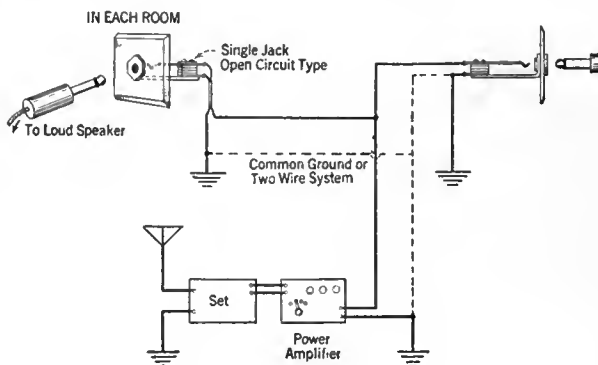

CENTRAL DISTRIBUTION PLAN

A series of jacks, one in each hotel room or apartment living room, may be connected in parallel to the output of a central receiver kept in tune by the telephone operator. A separate ground for each jack is often advisable, it being as near to the jack as possible

hither, thither, and yon, by those who may be soured on radio, the radio art is yet a sound and promising field for men, young or middle-aged, or even old. Its possibilities are so tremendous that one can scarcely grasp them. A field for radio not generally realized will be discussed here.

Have you ever stopped to consider how radio in real estate is a genuine asset? Only last month one realty firm of note advertised that their new subdivision of houses was in an excellent location for radio, in other words, out of the dead spot zones.

Now then, how many new houses are being built by companies of large operating facilities in your neighborhood? Perhaps ten, fifty, a hundred, or maybe a thousand, depending upon where you live.

Would these houses sell more readily if they were equipped with antenna and ground, and convenient con-

### STURDY ERECTION A PRIME FACTOR

**A**ND here is another stunt. How about these tanglefoot rooftops which entrap the wary burglar or zealous fireman with equal facility? More rigid fire regulations will surely

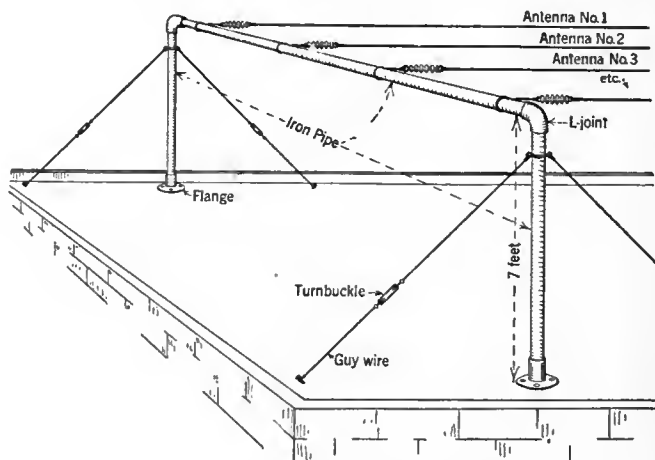

A NEAT MULTIPLE ANTENNA ARRANGEMENT

By the use of iron piping supports, several antennas may be supported without fear of disaster during heavy storms

# Send for this New Hookup

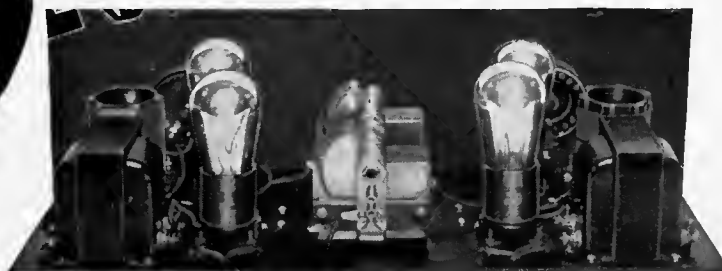

## Four Tube Receiver

Here is the outstanding radio receiver development of the season, in which is combined the genius of two of the most successful and distinguished radio engineers, assisted by the engineering and laboratory staffs of seven prominent radio manufacturers. Here is a receiver for the home builder that will represent for several seasons to come a far greater value than any other design available. Send for the book. Read how to obtain the following

### Startling New Features

**SINGLE CONTROL**—But one tuning or station selector control.

**SELECTIVITY**—In a residential district of New York City, within a few hundred yards of powerful stations, thirty-five stations were heard between 9 and 10 p. m. on the loud-speaker. KFI, in Los Angeles, was heard with ample volume to fill two rooms. Tests in Chicago brought in either coast with ample speaker volume, and indicated that a consistent range of 1,000 to 2,500 miles might be expected.

**QUALITY**—Two new-type Thordarson power amplifying transformers possessing a substantially flat frequency characteristic over the range of 40 to 6,000 cycles, give a quality of reproduction so perfect that comparison by the best trained human ear with other types of amplifiers will not reveal any superior type.

**VOLUME**—In all cases the volume will exceed that obtainable from other four-tube receivers, and in practically all cases equal or exceed that obtainable from standard five and six-tube receivers.

**UNLIMITED WAVELENGTH RANGE**—Through the use of interchangeable coils, the wave-length range is practically unlimited.

**WIRING AND ASSEMBLY**—All wiring is carried in a special harness. Since each wire is exactly the right length, and has a special color, it is impossible to go wrong in wiring. No soldering is needed unless preferred by the builder. Only a screwdriver and a pair of pliers necessary to assemble this set in less than two hours.

Over-all design, rugged and solid. Adapted to practically any standard cabinet, any standard tube, any battery or eliminator source of supply, outdoor antenna or loop. While the parts are the best that the leading laboratories of the country afford, the set can be built at an extremely low cost. Full description of the receiver will be published in the March issue of Popular Radio.

Get the hand book at your nearest Radio Dealer or clip the coupon and send with 25 cents TO-DAY. Address

No choicer group of radio products has ever been embodied in a single radio receiver. Not only are these manufacturers nationally known and accepted as the leaders in radio design and construction, but they have developed for the S-C receiver many new features which will create a new standard in reception throughout the radio world.

#### Represented Manufacturers:

**Belden Mfg. Co.**  
*S-C Wiring Harness*

**Central Radio Laboratories**  
*Centralab Resistance*

**Polymet Mfg. Corporation**  
*Fixed Condensers, Leak and Leak Clips*

**Silver-Marshall, Inc.**  
*Variable Condensers, Coil Sockets, Coils, Tube Sockets, Vernier Dial, Mounting Brackets*

**Thordarson Electric Mfg. Co.**  
*Equipformer Audio Transformers*

**Poster & Co.**  
*Drilled and Processed Front Panel and Drilled Sub-Panel*

**Yaxley Mfg. Co.**  
*Rheostat, Jacks, Switch*



**The S-C Merchandising Committee:**

106 S. Wabash Avenue • Chicago

**The S-C Merchandising Committee**  
106 S. Wabash Ave.  
Chicago

Gentlemen: Please find enclosed 25c, for which send me hand book of the new S-C Receiver.

Name \_\_\_\_\_

Address \_\_\_\_\_



## -it's in the Tube

A receiving set is no better than its tubes.

With other parts and connections *right* a set may be as good as its tubes—no set can be better.

That's why you want CECO Tubes. They stand up and deliver. With them your set works at its maximum. Clarity of tone, rich volume, long life—CECO has them all to a superlative degree.

Our charted tests (results confirmed by laboratories of national reputation) PROVE CECO TUBE SUPERIORITY—whether used as detectors, audio or radio frequency amplifiers.

CECO Tubes make a Good Receiver BETTER. Try them and you'll BUY them always—for results.

**Now Ready!** CECO Tubes with new type Long PRONG BASES. Also, Power Amplifier Tubes, E (Dry Cell Type), F (Storage Battery), for last stage of Audio Frequency.

Dealers write giving jobber's name.

C. E. Mfg. Co., Inc.

702 Eddy Street, Providence, R. I.

# CECO TUBES

## REMEMBER! WHEN BUILDING THE ROBERTS', KNOCK-OUT AND ARISTOCRAT

receivers that CLAROTUNERS are easier to mount, easier to hook-up, and that a more even approach to the point of MAXIMUM AMPLIFICATION is effected with CLAROTUNERS.

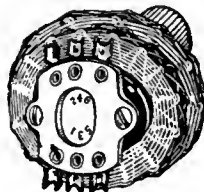

### DO YOU KNOW

that CLAROSTAT is the perfect variable resistor, having a greater range and a greater carrying capacity than any other, and that it is the only logical resistor for the UNIVERSAL receiver?



Send Stamp for Hook-ups

American Mechanical Labs., Inc.

285 North Sixth Street

Brooklyn, New York

## A KEY TO RECENT RADIO ARTICLES

By E. G. SHALKHAUSER

*THIS is the fifth installment of references to articles which have appeared recently in various radio periodicals. Each separate reference should be cut out and pasted on cards for filing, or pasted in a scrap book either alphabetically or numerically. An outline of the Dewey Decimal System (employed here) appeared in the November and January RADIO BROADCAST, and will be reprinted in an early number.*



R382. INDUCTORS. COILS.  
QST. Dec. 1925, pp. 9-12.  
"Toroids," F. J. Marco.

Through the increased use of radio frequency amplification, coils have been designed which are said to give greater selectivity than is the case with common solenoid coils. The toroid coil is an outgrowth of some of these newer developments. It has practically no external field. Considerable theoretical and practical data accumulated by the author, is presented. The advantage of this new coil lies in the lessening of interstage magnetic coupling. It does not nullify interstage oscillations in r. f. amplification.

R582. TRANSMISSION OF PHOTOGRAPHS. PHOTOGRAPH TRANSMISSION.  
QST. Dec. 1925, pp. 12-17.  
"Practical Picture Transmission," T. P. Dewhurst.

The Jenkins Laboratories have two picture transmission machines available for amateur use, the "Midget" and the "Junior." Both of these instruments are pictured and described in detail. Certain facts regarding the use of the apparatus and method of operating it are considered. Circuit diagrams are shown and explained.

R386. FILTERS. FILTERS.  
QST. Dec. 1925, pp. 24-26.  
"Amateur Filter Problems," F. S. Dellenbaugh.

A summary of problems pertaining to low-pass filters from 25 cycles a. c. to commutator ripples in generators, is given. A full page of design data covering construction of induction coils with carrying capacity of .05-.5 amperes, is included. The "brute force" and "intelligence" method of filtering are discussed, and diagrams shown. Tests of filter action using telephone induction coil and headphones are diagrammatically included.

R357. FREQUENCY CHANGERS. FREQUENCY DOUBLING.  
QST. Dec. 1925, pp. 29-30.  
"Frequency Doubling in Vacuum Tubes," T. T. Greenwood.

A method whereby the ordinary three-electrode tube may be used to double the output frequency in a circuit, is described. Use is made of the decrease of grid current for either increase or decrease of plate potential. Diagrams illustrate the points under consideration.

R374. DETECTORS, CRYSTAL. CRYSTAL.  
QST. Dec. 1925, pp. 31-32.  
"The New Carborundum Detector," M. L. Hartmann and J. R. Meagher.

A fixed crystal detector for broadcast receivers is described. Carborundum is used since this crystal is superior to any others, considering electrical stability and permanence. It has been developed to a point, according to the author, where its use may be an asset to modern receiving sets. The commercial product is shown and circuit diagram given.

R402. SHORT WAVES. SHORT-WAVE TRANSMISSION.  
Proc. I. R. E. Dec. 1925, pp. 677-683.  
"An Investigation of Transmission on the Higher Radio Frequencies," A. Hoyt Taylor.

A preliminary range chart has been constructed for telegraphic communication, 5 kw. in the antenna, at various frequencies. The conclusions upon which the range chart is based are derived from experiments made by the Naval Research Laboratory, from experiments made by amateurs, and from such data as the Laboratory has had access to from commercial and Government sources at home and abroad.

An attempt has been made to indicate in a general way the advantages and disadvantages of high frequency telegraphic transmission. Various critical regions are pointed out where new phenomena make their appearance; (1) region between 2000 and 3000 kcs. (2) region around 6000 kcs. (3) developments at higher frequencies of uncertain ranges.

The development of a missing region to extensive areas is shown to take place with a frequency rise to 20,000 kcs. The chart also attempts to indicate, in a general way, the region of uncertain communication and the regions where further exploration is urgently needed. It is quite evident that the range data is far from complete and that many individual cases will be found in contradiction to the chart, but it does represent a general average of the situation as it presents itself to the engineers in the Naval Service.

R115. DIRECTIONAL PROPERTIES. DIRECTIONAL RECEIVERS.  
Proc. I. R. E. Dec. 1925, pp. 685-707.  
"A New Directional Receiving System," H. T. Friis.

The paper discusses methods of combining the signal currents from the different antennas in a directional receiving system, and a detailed description is given of a system by which all phase and amplitude adjustments are performed upon the beating current inputs of a double detection receiver. The theoretically derived shape of the directional characteristic of a two-loop system has been verified by experiments, and data on reduction of static for such a system are given. Photographs and diagrams are shown of all the apparatus used.

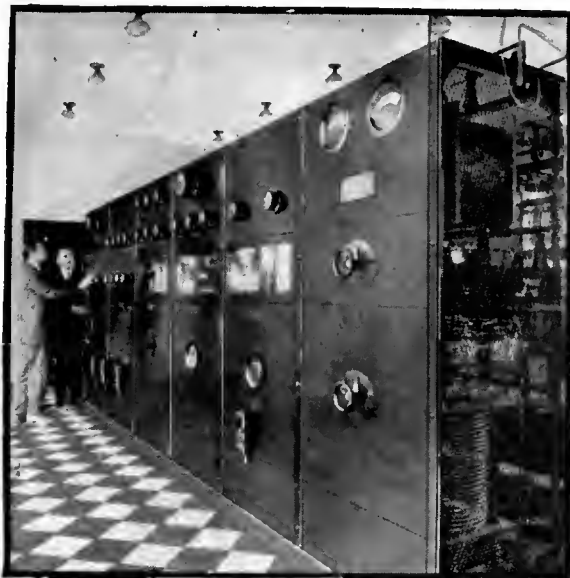

**\$50. to \$250 a week  
IN WORK THAT IS  
ALMOST ROMANCE**

## Be a Radio Expert

Get into the great new Big-Pay Industry—Radio. If you're earning a penny less than \$50 a week, **clip coupon now.** Send for **AMAZING FREE BOOK.** Be a Radio Expert and draw down big money for the easiest and most fascinating work in the world. Positions everywhere. Thoroughly-trained men are in big demand. Need for Radio Experts in every community. Short hours. **BIG PAY. Free book gives all the facts.** Astonishing opportunities — thousands of them! Every day N. R. I. trained men are taking good places in the Radio field. Free book tells all about their success. Send for it now!



## Learn Quickly and Easily AT HOME

Master Radio Engineers will show you how to qualify quickly and easily at home, for Radio's fine jobs. We **guarantee** to train you successfully. Lack of experience no drawback—common schooling all you need. Our tested, clear methods make it easy for you. Send coupon now for free proof.

### Instruments Given with Course

All instruments shown here and many others given to students for practice work while learning. Receiving sets, from simplest kind to thousand mile receiver. An **UNEQUALLED OFFER.** Many other big features for limited time only

### Famous Training That "Pays for Itself"

Spare-time earnings are easy in Radio. Increase your income almost from the start through practical knowledge we give you. This is the famous **practical training that pays its own way.**



### Operates WMAQ

"Accepted a position with Chicago Daily News—Station WMAQ. My income practically doubled thanks to your fine course."

KEITH KIMBALL, Chicago.



### Gets Big Job

"Just been made Sales Manager of this Radio concern—a big raise in pay. Regret I did not take course sooner."

R. E. JONES, Bay City.

Get  
this  
Amazing  
Book

Most amazing book on Radio ever written—full, interesting facts about this great field and how we prepare you and help you start. You can do what others have done. **GET THIS BOOK.**

### SEND COUPON

Send coupon to-day for special limited offer, including all instruments—you'll get full particulars by return mail.

**National Radio Institute**

Dept. CU5, Washington, D. C.

You get  
all of  
these



## MAIL THIS NOW

**NATIONAL RADIO INSTITUTE**  
Dept. CU5  
Washington, D. C.

Without obligating me in any way, send me your free book, "Rich Rewards in Radio," and all information about your practical, home-study Radio course.

Name.....Age.....

Address.....

Town.....State.....

**LARGEST RADIO SCHOOL IN THE WORLD**

**ORIGINATORS OF RADIO HOME-STUDY TRAINING**

# New "AMSCO" Products

*The choice of  
Leading Radio Engineers*

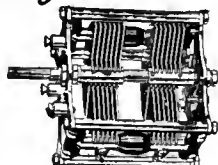

## AMSCO SIAMESE CONDENSERS

Used by William H. Preiss in his "Straight 8" Receiver, R. E. Lacault in his "Ultra-dyne," L. M. Cockaday in his "L. C. 26" Receiver, and specified by Lester L. Jones for single control receivers.



## DE LUXE MODEL AMSCO VERNIER DIALS

Now finished in gold, silver, and jet. Free acting-forward or backward, fast or slow, without momentum or backlash. Gives finesse to fingers.

## FOR STRAIGHT-LINE AMPLIFICATION

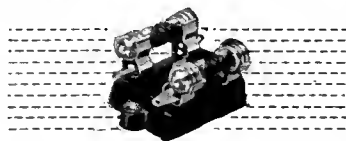

## AMSCO RESISTANCE COUPLERS

The perfected instruments for straight-line amplification. All frequencies within the voice and music ranges, from the highest treble to the lowest bass, are augmented equally, giving true tone reproduction without distortion.

Investigate AmSCO Resistance Couplers, Grid Gates and Resistors.



## It Clicks into Contact

## AMSCO UNIVERSAL SOCKET

All standard UX and CX radio tubes snap in with a click that assures positive contact.

Patented AmSCO construction fully enclosed in genuine Bakelite. One hole mounting. They save space



**AMSCO PRODUCTS, INC.**  
Broome & Lafayette Sts., New York

# Make your set a Super-Het

THE circuit described in Radio Broadcast for June and August will change any set into a super-heterodyne. It is particularly applicable to five-tube neutrodyne and tuned RF sets. It changes these two circuits into super-heterodynes as good as most, and considerably better in some respects than any super-heterodyne circuit ever devised.

Stations come in at but one point on the oscillator dial. There is mathematically no possibility of harmonics. Full scale blue prints with reprint of article \$1.00.

Eastern Coil antenna coupler .....	\$6.00
O'Connor oscillator coupler .....	4.75
Special fixed condenser .....	.60
Complete parts including panel, drilled and engraved, special formica bushings, screws, and wire, blue prints and reprint.....	37.50

★ **A. O'CONNOR & COMPANY**  
Super-Heterodyne Headquarters Since 1923  
9702 Euclid Avenue . . . . . Cleveland, Ohio

R140. CIRCUITS. **CIRCUITS, Radio.** Dec. 1925, pp. 26 ff. **Transmitting.**  
"How to Identify the Transmitting Circuits," Lieut. J. B. Dow, U. S. N.  
An oscillating tube circuit is used for transmitting purposes. Six basic circuits, the Meissner, Coupled plate, Coupled grid, Hartley, Modified Hartley, and Colpitts, are listed by the author, together with diagrams and a general discussion. Other circuits, such as the grid condenser and leak system, are considered modifications of the fundamental ones. Some of the modifications are taken up and diagrams shown.

R343. ELECTRON TUBE RECEIVING SET. **RECEIVER, Popular Radio.** Dec. 1925, pp. 495-511. **LC-26.**  
"LC-26 Receiver," L. M. Cockaday.  
A receiver considered by the author as the best one yet constructed, and available in parts for the radio experimenter, is described. It is a five-tube resistance-coupled set. Front, rear, and side views, including wiring diagram and list of parts, are shown. All details pertaining to the set are carefully presented.

R381. CONDENSERS **CONDENSER Popular Radio.** Dec. 1925, pp. 521-525. **LOSSES**  
"Condensers," S. Harris.  
The question of losses in condensers is a difficult problem in radio engineering, but one should have some idea about high frequency resistances in condensers. The radio experimenter will have no difficulty in understanding some of the effects due to eddy currents, dielectric losses, etc., the author believes. A simple method of measuring such losses in condensers is presented by the writer.

R550. BROADCASTING. **INSTRUMENTS, Popular Radio.** Dec. 1925, pp. 526-532. **Placing of**  
"The Oboe in 4-D," T. L. Bayard.  
"The location of each instrument in group radio transmission, orchestra or band, before the studio microphone, is a problem which has been studied at some length and solved to some extent by engineers of station KDKA at Pittsburgh. Charts and explanations furnish the reader with considerable detailed information.

R582. TRANSMISSION OF PHOTOGRAPHS **PHOTOGRAPHIC Popular Radio.** Dec. 1925, pp. 540-544. **TRANSMISSION.**  
"Pictures by Telephone or Radio," E. H. Hansen.  
A new method of transmitting pictures by radio, called the "Phono-Photo" method, is described. Fundamental data on present types of systems developed, are reviewed and compared with the system presented by the author. A photo-electric cell is required, actual pictures being transmitted over the ordinary telephone lines in a remarkable short time.

R261. ELECTRON TUBE VOLTMETERS. **VOLTMETERS, Popular Radio.** Dec. 1925, pp. 552-555. **Vacuum Tube.**  
"A Vacuum Tube as a Voltmeter," L. M. Cockaday.  
A three-electrode vacuum tube is used as a voltmeter to cover a considerably greater range than the voltmeter in common use, since it can be applied to either d. c. or a. c., from a fraction of a volt to several hundred volts. An explanation of its uses, and the method of applying it, is given in detail. Circuit diagram and apparatus assembled, is shown.

R382. INDUCTORS. **INDUCTANCE Popular Radio.** Dec. 1925, pp. 559-561. **VALUES.**  
"The Relative Merit of Some Types of Inductance," B. B. Minnium.  
The author presents a careful analysis of several types of inductance coils, mainly pertaining to the method of winding them, and makes a comparison of their relative L-R values. Some conspicuous results are obtained, which should be considered carefully before deciding which coils are the best. A graph shows the L-R ratio and the wavelength plotted for six types of windings. The torus coil appears to be far the poorest coil investigated.

R364. CRYSTAL DETECTORS. **CRYSTALS, Popular Radio.** Dec. 1925, pp. 575-576.  
"Do Impurities Improve Crystal Detectors?,"  
Doctor Wherry, of the Bureau of Chemistry, presents one of the most complete lists of crystal detector minerals and their composition, which has ever been published. It appears that crystals with some impurities are better for high frequency detecting purposes than the pure minerals, although there are some exceptions.

R342.7. AUDIO-FREQUENCY AMPLIFIERS. **AMPLIFICATION Radio Broadcast.** Jan. 1926, pp. 313-316. **Audio-Frequency**  
"Additional Notes on the Model 1926 Receiver," E. R. Pfaff.  
The author describes an improved audio amplifying unit to be used with the McMurdo Silver receiver (described in Nov., 1925, RADIO BROADCAST) using transformer, resistance, or choke-coil coupled amplifiers. In using increased plate voltages for power tubes, it is frequently necessary to use a shunt method of horn connection for good results. Resistance coupling, with its advantages and precautions to be observed, is reviewed at length.

R402. SHORT WAVES. **SHORT-WAVE Radio Broadcast.** Jan. 1926, **TRANSMITTER.**  
pp. 321-325.  
"A Universal Short-Wave Transmitter," N. Hagemann.  
The construction of a high frequency telegraph transmitter, using receiving parts, is described. The circuit shown is capable of steady oscillations even when plate or filament current should vary somewhat. Complete instructions, wiring diagrams, and photographs are given.

R343. ELECTRON TUBE RECEIVING SETS. **RECEIVER, Radio Broadcast.** Jan. 1926, pp. 331-336. **Universal.**  
"Radio Broadcast's Universal Receiver," A. H. Lynch.  
The article starts with a general review of the radio parts situation at the present time and proceeds to give a detailed account of several good receivers which may be built by the home constructor. The "Universal," an exceptionally efficient four-tube receiver, using one r. f. stage, tuned and neutralized, a regenerative detector, and good audio stages, is described, photographs serving to illustrate the general layout of instruments.

# Every Radio Fan should have this book

JUST OUT—514 PAGES



Compiled by  
**HARRY F. DART, E.E.**  
Formerly with the Western  
Electric Co., and U. S. Army  
Instructor of Radio.  
Technically edited by  
**F. H. Dosoe**

**NO MORE** need you turn from book to book, hoping to find what you want. It is all here, in 514 pages crammed full of every possible radio detail. Written in plain language, by engineers for laymen. 100,000 sold.

**IT EXPLAINS:** Electrical terms and circuits, antennae, batteries, generators and motors, electron (vacuum) tubes, many receiving hook-ups, radio and audio frequency amplification, broadcast and commercial transmitters and receivers, super-regeneration, codes, etc.

Send \$1 today and get this 514-page I. C. S. Radio Handbook—the biggest value in radio today.

International Correspondence Schools  
Box 8299-E, Scranton, Penna.

I enclose One Dollar. Please send me—post-paid—the 514-page I. C. S. Radio Handbook. It is understood that if I am not entirely satisfied I may return this book within five days and you will refund my money.

Name.....

Address.....

Check here  and enclose \$1.50 if you wish the edition bound in Leatheroid.

# Free 3 Lessons

You can play the sax in an hour and play Jazz in a week on the

## Buescher Saxophone

We give 3 free lessons with each new instrument. They start you. Teach yourself. It's great fun practicing because you learn so quickly. Even though you have failed with some other instrument, you can learn the Buescher Saxophone. And it will make you the most popular person in your set. 6 days' free trial in your own home, any instrument. No obligation. Easy terms if you decide to buy. Send now for beautiful free literature. A postal brings liberal proposition. Address:



Buescher Band Instrument Co. (9)  
1220 Buescher Block Elkhart, Indiana

# Hoyt Radio Rotary Meter



Price #24

This unique meter will do all testing necessary on Radio receiving sets, tubes, batteries and battery eliminators. It furnishes the experimenter and Radio dealer with a single instrument with 5 different ranges, reading from as low as 1/4 milliamperes or 1.8 volt to 7.5 milliamperes or 150 volts. Operation is simple and accident-proof.

**BURTON-ROGERS CO.**  
26 Brighton Ave. Boston, Mass.

# RADIO PEP

## B-BATTERY ELIMINATOR

### NO TUBES NO HUM



## Buy no more B-batteries!

**U**SE the unlimited supply of cheap, dependable electricity right at hand in your household lighting circuit.

This can be done with *permanent* satisfaction with **RADIO PEP**.

**RADIO PEP** is the **FIRST** eliminator to completely solve the problem, as it is the only one made with **EIGHT PERFECTED ELECTROLYTIC CELLS**, replacing tubes and doing away with all the familiar tube troubles.

Two or four cells *overloaded* will not give **PERMANENCE** and **POWER**—the outstanding characteristics of **RADIO PEP**.

**135 VOLTS** are called for by the modern sets and tubes; here you get it year after year without weakening.

For 110-125 volts, 60-cycle alternating current.

Send for particulars and name of our nearest dealer. Price \$38. Money back guarantee.



**PEP MFG. CO., Inc.**

33 West 42nd Street

New York



# ACME WIRE RADIO PRODUCTS

## Celatsite Wire

Celatsite is a tinned copper bus bar wire with a *non-inflammable* "spaghetti" insulation in five colors. Supplied in 30 inch lengths.



## Flexible Varnished "Spaghetti"

A perfect insulation tube for all danger points in set wiring. Costs little more and is worth a lot more than the cheaper substitutes offered. Black, yellow, red, green, brown, for wires No. 10 to No. 18. 30 inch lengths.

## Celatsite Battery Cable

For connecting A and B Batteries (or current supply) to radio set. Silk braid covering 5 flexible Celatsite wires—5 feet long—a different color for each terminal. Prevents messy wiring and "blown" tubes. Adds greatly to the appearance of your set.



## Enameled Antenna Stranded

The best outdoor antenna you can put up. 7 strands of enameled copper wire; maximum surface for reception. Enameling prevents corrosion and consequent weak signals. 100, 150 or 200 foot coils, boxed.



## Loop Antenna Wire

You can make a good loop with Acme wire made of 65 strands of fine copper wire, green silk covered. Flexible; non-stretching, neat.

## Flexible Celatsite Wire

Flexible stranded wire for "point to point" and sub-panel wiring—latest method of wiring sets. 5 colors, black, yellow, green, red and brown, one for each circuit. 25 ft. coils.



Send for Folder

THE ACME WIRE CO., Dept. B  
New Haven, Conn.



R550. BROADCASTING. STATION.  
*Radio News*. Dec. 1925, pp. 798 ff. *Broadcasting*.  
"What Happens In the Broadcast Station," A. P. Peck.  
A fundamental description of the operation of a modern broadcasting station, including the principles of sound vibrations, the purpose of the microphone, the operation of the transmitting tubes, the method of modulating high frequency currents, and the equipment of the rooms housing the broadcasting station.

R142.3. INDUCTIVE COUPLING. COUPLING.  
*Radio News*. Dec. 1925, pp. 800 ff.  
"Coupling—Tight or Loose?," S. Harris.  
In this article, the first of a series, is presented a mathematical treatise on the question of coupling between coils. Actual measurements, made with different coils, are shown graphically, with constants of the coils given. Only concentric coils are considered, variations being made in diameter of coils, number of turns, and position of primary with respect to secondary (whether in center or to one end). The effect of the antenna constants, when considered with coil coupling, is another important factor.

R402. SHORT WAVES. TRANSMITTER, *Short-Wave*.  
*Radio News*. Dec. 1925, pp. 803 ff. *Short-Wave*.  
"The Baby Transmitter," W. B. Schulte.  
A complete description of a low power transmitter using uv-109 tube, and operating at high frequencies (7500 kc.), is given. The modified Colpitts oscillator used, was developed at the Burgess Laboratories. Ordinary dry batteries furnish the plate and filament supply. The circuit diagrams show clearly how this set can be constructed.

R334. FOUR-ELECTRODE TUBES. ELECTRON TUBES, *Four-electrode*.  
*Radio News*. Dec. 1925, pp. 804 ff. *Four-electrode*.  
"Multiple Grid Vacuum Tubes and Their Advantages," T. H. Nakken.

The author presents an analysis and working principle of a two-grid tube, giving its advantages and theory of operation. One grid is connected directly to part of the B battery voltage in order to neutralize the space charge within the tube. The other grid performs its regular functions as in three-electrode tubes. It is said that capacity effects between grid and plate may be prevented by this unique arrangement of grids. As a power tube, this device has many possibilities.

R402. SHORT WAVES. TRANSMITTER, *Five-Meter*.  
*Radio News*. Dec. 1925, pp. 807 ff. *Five-Meter*.  
"Five-Meter Transmission," R. E. Kolo.  
The construction of a transmitter and receiver operating on 50,000 kc. (5 meters) and the arrangement of Lecher wires to measure these high frequency currents, is given. The University of Illinois experimental station worked out the apparatus design. Data on construction and operation is given in detail.

R381. CONDENSERS. CONDENSERS, *Electrolytic*.  
*Radio News*. Dec. 1925, pp. 808 ff. *Electrolytic*.  
"Electrolytic Condensers," T. A. Smith and J. Millen.  
A description of the much talked of electrolytic condensers, is presented. Tables give relation of capacity to voltage formation values and the critical voltages for aluminum anodes with various electrolytes. Construction of such condensers for transmitting and receiving purposes, and proper sized choke coils to be used for good results, is part of the information given to enable the constructor to build his own.

R375. DETECTORS; RECTIFIERS; MISCELLANEOUS. ELIMINATORS,  
*Radio*. Dec. 1925, pp. 15 ff. *A, B, and C Battery*.  
"The A B C Battery Eliminator," G. M. Best.  
The construction of an eliminator to replace the A, B, and C batteries, thus operating the radio receiver from the regular 110 volt a. c. power circuit, is described. Any set using up to and including eight tubes, may connect to this eliminator. Some changes in wiring are necessary in the set. A list of complete parts are given and diagrams shown. The construction of the eliminator is not difficult, and is considered quiet in operation. Rewiring diagrams for the Browning-Drake and also an eight-tube super-heterodyne, are given.

R073. TRAINING OF OPERATORS. EXAMINATIONS, *Government*.  
*Radio*. Dec. 1925, pp. 22 ff. *Government*.  
"Passing Your Next Radio Examination," C. W. Rados.  
Complete information is presented concerning the license examinations for amateur and commercial operators. These examinations are conducted by the Department of Commerce and may be taken at any one of the district offices. A code test comes first, followed by an examination in theory and laws of radio communication. A sample code test is also included in this very complete article.

R343. ELECTRON TUBE RECEIVING SET. RECEIVER, *Browning-Drake*.  
*Radio*. Dec. 1925, pp. 25 ff. *Browning-Drake*.  
"The Single Control Browning-Drake Receiver," H. A. Nickerson.  
A method of converting the Browning-Drake circuit to single control is described, using two condensers mounted on one shaft. This circuit is well adapted to such an arrangement, writes the author. The principle of operation, with the change suggested, is considered at some length. Other changes to be made are also given consideration.

R143. DAMPING; DECUREMENT. DAMPING.  
*Radio*. Dec. 1925, pp. 29 ff. *Damping*.  
"Damping," L. R. Felder.  
A fundamental and simple explanation of the question of "damping," also called "decurement," is given. "Damping" is found in all radio circuits, since they all have more or less resistance. It will increase broadness of resonance as explained and indicated graphically. This problem must therefore be considered in the design and efficiency of all radio apparatus.

R242. REACTANCE-VARIATION METHOD. COIL MEASUREMENTS.  
*Radio*. Dec. 1925, pp. 31. *MEASUREMENTS*.  
"A Standard of Coil Comparison," G. F. Lampkin.  
The author makes a plea for expressing in some standard way the meaning of coil efficiency. He suggests that the ratio of L-R be used, and gives his reasons, explaining this ratio of reactance to resistance at some length.

This is a good time to subscribe for

RADIO BROADCAST

Through your dealer or direct, by the year only \$4.00

Doubleday, Page & Company

Garden City, New York

WHOLESALE EXCLUSIVELY

## LUDWIG HOMMEL & CO

929 PENN AVENUE HOMMEL PITTSBURGH, PA.

**SATISFIED DEALERS  
BECAUSE  
WE HELP THEM**

*Catalog 466-B is free to Dealers*



# CHELSEA Super-Five

\$50

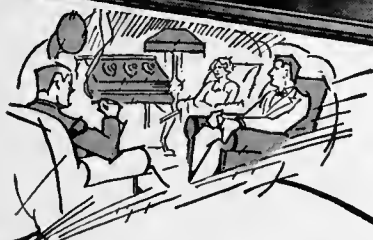
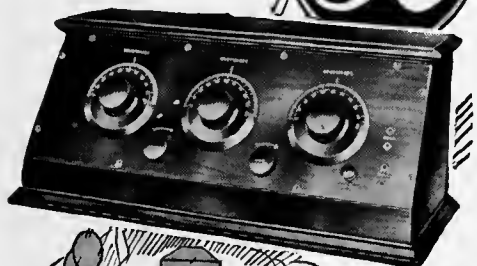

## EVERYwhere— Winning New Friends

**T**HAT'S exactly what the new Chelsea Super-Five is doing because it offers supreme performance at a popular price. Each Super-Five is housed in a beautiful mahogany-finish cabinet with graceful sloping panel and large over-size dials for easy tuning. Dust-proof, fool-proof inside panel to protect the "vitals." Hand soldered connections. Rugged bus-wiring throughout. Convenient cord leads for making all connections.

See these Chelsea features at  
Your Dealers. Write Us  
for Folders.



CHELSEA RADIO COMPANY  
CHELSEA, MASS.

This is a good time to subscribe for

**RADIO BROADCAST**

Through your dealer or direct, by the year only \$4.00

DOUBLEDAY, PAGE & CO. GARDEN CITY, NEW YORK

## MORE PROFITS for the PROFESSIONAL SET BUILDER

**W**E have an unusually interesting proposition to make to the man who is now building (or has the ability to build) radio receiving sets for resale. This is a real opportunity. Write today for full information.

**Gearhart-Schlucter Radio Corp.**  
716 Voorman Ave. Fresno, California

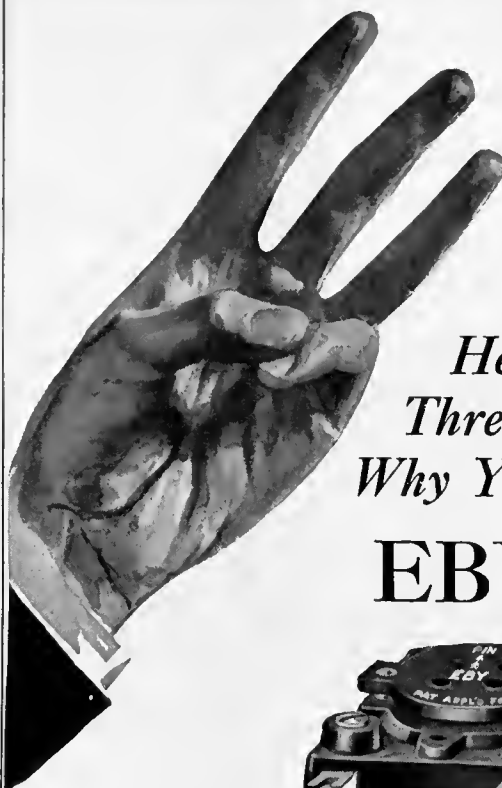

Here Are  
Three Good Reasons  
Why You Should Use

# EBY

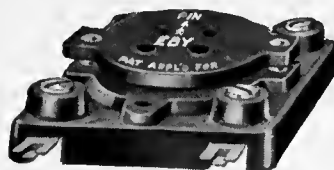

## SPRING SOCKETS

- 1** A three point wiping contact that insures a positive contact at all times regardless of the size of the prong or amount of solder on the prong tip.
- 2** Its ingenious design permits the tube to "float" when in service. This feature reduces microphonic noises to a minimum and prevents tube damage.
- 3** All the advantages of interchangeability of the new UX, CX, and UV tubes for 6oc. Don't take chances on twenty loose connections in a five-tube set. Use the new EBY positive contact sockets for better reception.

If your dealer can't supply you  
write to us sending his name.

**H. H. EBY MANUFACTURING CO.**  
4710 Stenton Ave., Philadelphia



This is the EBY Binding Post that is standard equipment on eight out of ten of the radio receivers made in America—your dealer has all of the 27 different markings.

## The Magic Dial



**\$2.50**

### AS AMAZING AS A STROKE OF MAGIC!

Variable condensers that are not straight line frequency, tune as if they were, if you install



If your dealer can't supply you, order direct. \$2.50.

### *Bruno* MAGIC DIALS

As if at the touch of a wondrous wand, stations otherwise crowded together—are evenly separated. Uncrowd the air with the Magic Dial! Genuine moulded Bakelite with fluted columns of Arabian inlay, \$2.50

"SLO-MOSHEN" VERNIER DIAL, \$2.00

### ★ Powertone Electric Co.

(Subsidiary of Bruno Radio Corp.)

Dept. P 223 Fulton St. N. Y. City

This is a good time to subscribe for

## RADIO BROADCAST

Through your dealer or direct by the year, only \$4.00

DOUBLEDAY, PAGE & CO.

GARDEN CITY, NEW YORK



TRADE MARK REG.

Above types in copper—tinned copper—enameled copper—tinned bronze.

Loop wires in silk or cotton covered.

Litz wires.

Enameled wires.

## RADIO WIRES

We manufacture all types.

Round braided antenna wires

Flat braided antenna wires

Round stranded antenna wires

Antenna supporting springs.

Cotton and silk covered wires for set wiring.

Write us for descriptive catalogue.

ROSS WIRE COMPANY

69 Bath St., Providence, R. I.

R134.4. REGENERATIVE ACTION. REGENERATIVE  
Proc. I. R. E. Dec. 1925, pp. 709-753. AMPLIFICATION  
"An Analysis of Regenerative Amplification," V. D.  
Landon and K. W. Jarvis.

This paper shows some of the defects of present theories regarding regeneration, and presents a new method of analysis based on the idea of a power balance. It is shown that a signal voltage does not supply power to a regenerated circuit, but merely prevents certain losses from occurring. This upsets the balance between power input from the tickler and power lost in the circuit, so that oscillation occurs. The amplification obtainable in this way has a definite limit, the limit being caused by variations in the plate and grid impedances of the vacuum tube, as the amplitude of the grid voltage increases. The rate of variation of these impedances as the grid voltage increases, depends on the tube and on the direct voltage used.

The use of a grid leak and condenser decreases the voltage amplification, by increasing the rate of change of the plate-filament impedance. In general, however, increased detecting efficiency more than makes up for the difference when audio frequency output is considered. The effect of resistance in the grid circuit is to decrease the amplification by increasing the effect of the impedance variations.

The best turn ratio to use in a regenerated transformer is the same ratio that should be used in a non-regenerated transformer. The amplification obtainable increases rapidly as the strength of an applied signal is decreased. Although the inductance-capacity ratio does not affect the amplification obtained on an a. c. wave train, this ratio does affect the amplitude of the audio output when a modulated signal is being amplified. If a low L-C ratio is used, high notes will be lost when a weak signal is being received with full regeneration.

Regenerative amplification also occurs when a tube is in a condition of self-oscillation, providing the strength of the local oscillation is weak. A regenerated circuit amplifies non-resonant frequencies to a certain extent, the amount depending on the value of the reactance that would be needed to tune the circuit to the non-resonant frequency.

R382.5. OSCILLATION TRANSFORMERS. INDUCTANCES,  
Proc. I. R. E. Dec. 1925, pp. 755-766. Air-Core,  
"Designs and Efficiencies of Large Air-Core Inductances,"  
W. W. Brown and J. E. Love.

Representative designs of large air-core antenna tuning inductances suitable for outdoor and indoor service, are described. The latest improved designs are described in greater detail and compared with earlier designs on a basis of efficiency and kilovolt-ampere capacity. Formulas are given for calculating the ohmic and eddy current conductor power factor of coils using finely stranded, separately insulated, strands. In graphical form are shown the variations of ohmic and eddy current power factor with frequency, with four different conductor windings in a given arrangement to given dimensions. Also the variation of the sum of ohmic and eddy current power factors, with frequencies for a representative conductor on various diameters, are given. These values were calculated by the formulas given, and indicate very high efficiencies for the latest types of coils.

R342.6. RADIO-FREQUENCY AMPLIFIERS. TRANSFORMERS,  
Proc. I. R. E. Dec. 1925, pp. 767-779. Radio-Frequency  
"An Efficient Tuned Radio-Frequency Transformer,"  
F. H. Drake and G. H. Browning.

A mathematical discussion of a new type of r. f. amplifying transformer is given, which, it is claimed, is capable of giving greater amplification per stage than other transformers now used. Circuit diagrams and charts are shown verifying the theoretical work done.

R610. EQUIPMENT; STATION DESCRIPTION. STATION,  
Radio News, Dec. 1925, pp. 770 ff. Broadcasting,  
"Britain's New Superpower Broadcasting Station," A.  
Dinsdale.

Great Britain's largest broadcasting station, located at Daventry, is described. Several photographs show interior and exterior arrangements. The present rated power output is 25 kw., although up to 60 kw. can be used in the future. The circuit design, oscillator, amplifier, modulator, and sub-modulator, are discussed separately. The tubes are water-cooled, the system employed being taken up in detail. The station frequency is 187 kc. (1600 meters), call letters 5 XX.

R113.1 FADING. FADING.  
Radio News, Dec. 1925, pp. 772 ff.  
"The Nature, Cause, and Reduction of Fading," G. W.  
Pickard.

Mr. Pickard discusses the inconstancy of the space circuit, giving a very exhaustive and complete study of the probable causes of fading. His explanations are supplemented by charts and data taken over long periods of time. From his observations it appears that the Kennedy-Heavyside layer theory does not explain day and night and seasonal variations, but the cause must be found elsewhere. A system of multipoint antennas for receiver, transmitter, or both, is proposed to improve conditions.

R130. ELECTRON TUBES. TUBES,  
Radio News, Dec. 1925, pp. 786 ff. Cold-Cathode,  
"Cold-Cathode Gas-Filled Discharge Tubes," C. B.  
Bazzoni.

Some fundamental principles pertaining to electron discharges through vacua, are presented. The Crookes dark space and the Faraday dark space in partially exhausted tubes, are two of the interesting phenomena explained at some length.

R350. GENERATING APPARATUS; TRANSMITTING SETS. TRANSMITTERS,  
Radio News, Dec. 1925, pp. 790 ff. Radio Telephone,  
"Transatlantic Radio Telephony," G. C. B. Rowe.

According to information in this article, the Western Electric Company will announce transatlantic radio telephone service on a commercial basis shortly. A new system of transmission, known as the single side-band eliminated carrier, is used. This system is described and illustrated. A special system of reception is necessary, a local oscillator being employed in order to properly detect the signals. The advantages of this new system are discussed at some length.

# Goodrich Silvertown

*The Radio Panel Supreme!*

- 1 Easier to drill and machine.
- 2 Better color, lasting lustre.
- 3 Lower free sulphur—no discoloration.
- 4 Higher softening point—no warping.

Goodrich V. T. Sockets      Spaghetti Tubing  
 Radiophone Ear Cushions  
 ★ Battery Mats  
 Hard Rubber Tubes for Coils

The B. F. Goodrich Rubber Company  
 Established 1870      Akron, Ohio



## Selected As The Best Variable Resistor

\$2.25

By the Raytheon Manufacturing Company and others, because it has no equal for voltage control in "B" Battery Eliminators.

A RANGE FROM ALMOST ZERO TO 5,000,000 OHMS and A CARRYING CAPACITY OF 200 milliamperes, ten times greater than that of any other variable resistor.

Consequently, in B Battery Eliminators, where so much depends upon a proper voltage control, its freedom from noise, the necessity of its carrying capacity and staying put when once adjusted—is where the CLAROSTAT is SUPERIOR.

If your dealer cannot supply you, write direct ★

**American Mechanical Laboratories, Inc.**  
 285-287 North Sixth Street, Brooklyn, N. Y.

Special types for "A" and "B" Battery Eliminators available for Manufacturers.

# SANGAMO Mica Condensers in intermediate sizes



IMPROVE  
TONE  
RANGE  
AND  
VOLUME

IT is accuracy, not luck, that makes one receiver sweeter and more powerful than another that is almost its twin. Especially condenser accuracy, for the closer you come to absolute accuracy at these critical parts, the more wonderful your receiver will be. The cost of accurate condensers is small—the effect is immense.

Now you can get Sangamo Mica Condensers in capacities in between the usual stock sizes, so you can build with greater accuracy than ever before. They are guaranteed to be accurate and they always stay accurate, being solidly molded in bakelite. Neither heat, cold, moisture, pressure nor acid fumes will affect their capacity, because bakelite seals the delicate parts against all outside influences.

*Capacities in microfarads and prices*

0.00004	}	0.001	}	50c.
0.00005		0.0012		
0.00006		0.0015		
0.00007		0.00175		
0.00008		0.002		
0.0001		0.0025		
0.00012		0.003		
0.00015		0.0035		
0.000175	}	0.004	}	60c.
0.0002		0.005		
0.00025		0.006		
0.0003		0.007		
0.00035		0.0075		
0.0004		0.008		
0.0005		0.01		
0.0006		0.012		
0.0007	}	0.015	}	1.20
0.0008		0.015		

With Resistor clips, 10c. extra

Also Sangamo By-Pass Condensers ★  
 1/10 mfd. 80c.      1/2 mfd. 90c.  
 1/4 mfd. 80c.      1 mfd. \$1.25

**Sangamo Electric Company**  
 6332-1      Springfield, Illinois

RADIO DIVISION, 50 Church Street, New York

SALES OFFICES—PRINCIPAL CITIES

For Canada—Sangamo Electric Co. of Canada, Ltd. Toronto.  
 For Europe—British Sangamo Co., Ponders End, Middlesex, Eng.  
 For Far East—Ashida Engineering Co., Osaka, Japan.



# The Best in the World

## No Batteries

are required even to operate the most powerful 10-tube receiver pictured above, if you use the new laboratory type

## Model A Power Unit

## One Customer Telegraphs:

**"Receiver assembled, performing like a thoroughbred."**

The Amateur or Experimenter with his ultra-modern high-powered receiver is years ahead of Commercial Radio.

It is significant that unsolicited testimonials are constantly being received from even the far corners of the earth, where Norden-Hauck Engineers have furnished the finest radio apparatus known to the art today.

Quotations gladly furnished on radio parts and apparatus having non-infringing uses.

Write for Literature



# NORDEN-HAUCK, Inc.

Engineers

1617 Chestnut Street, Philadelphia, Pa.

demand a changing of this bad condition. Who is going to be the bright fellow to straighten it out at a profit to himself?

A survey of most apartment-house roofs in the country will show what has to be done. Far beyond the unsightliness of these trap-maze, antenna-ridden roofs, it is not pleasant to have to duck and dodge such affairs when bent on getting a breath of fresh air.

There are two ways to get this thing ironed out. Dr. A. Hoyt Taylor has invented a multiple-tap antenna from which as many as a hundred sets can be connected. Why not apply this principle to rigging up apartment house roofs in a more workmanlike manner?

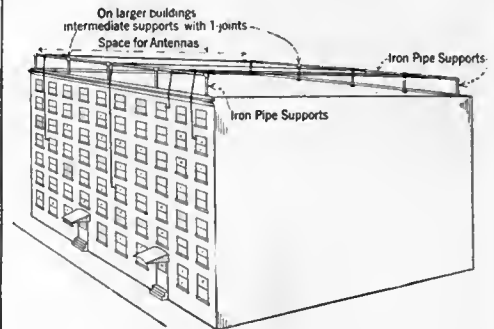

A STOUT ANTENNA SYSTEM

In which the possibility of a tangled mass of collapsed antennas is greatly mitigated. Nowadays the average apartment house rooftop is "enhanced" by a multiplicity of awkwardly arranged antennas in all stages of confusion

Or again, the use of a solid spreader at either end of a roof made of iron pipe and joints, properly braced, and carrying a whole gang of antennas at a safe height above the roof, is easy to set up.

Who is going to get this business? It is there, waiting for somebody. Big or little; a crowd of young men interested in radio should have no trouble in making their knowledge pay them big dividends.

Here are some sketches to show you just how to solve such problems. It is essential that radio encourage young men, all men, in fact, to get into the game and use their knowledge for the advancement of the craft. There is always a scarcity of men who know their business, especially in radio.

There are more men versed in the bread-and-butter knowledge of radio, of a type fitted to perform the work outlined here, than in almost every other industry. You men who read this publication must know quite a bit about radio.

Put your knowledge to work. It means money to you; it means experience, and new minds, and more willing hands to do the work that radio needs to have done.

## DEMAND FOR RADIOS INCREASES IN CZECHOSLOVAKIA

FOLLOWING a severe depression in the radio business during the summer months in Czechoslovakia, things are now beginning to look up again, and the last few winter months have seen quite a strong demand for radio equipment. It is extremely difficult to obtain accurate figures of the total number of receiving sets now in use, but two reliable sources estimate this figure to approximate 20,000, of which 8000 are located in the city of Prague, where is a 5000 watt broadcasting station. At present there are forty-nine manufacturers of radio equipment in Czechoslovakia, but they do little business, most of the apparatus there being of foreign manufacture.

Why not subscribe to *Radio Broadcast*? By the year only \$4.00; or two years, \$6.00, saving \$2.40. Send direct to Doubleday, Page & Company - Garden City, New York.



## Burns Speaker with Concert Unit

*The Heart of the Speaker*

Large size and scientific construction of the Concert Unit gives the remarkable tone values which combined with the special amplifying properties of the BURNS horn produce remarkable results.

Burns horn is of distinctive design with pyralin flare in several handsome finishes.



Manufacturers  
*American Electric Company*

State and 64th Streets, Chicago, U. S. A.

**NEW PROFITS  
for RADIO DEALERS**



The B & R 5 Battery Charger will charge 5 Radio "A" batteries at once. Built for 110 volts, no power line needed. Plug it in on any lamp socket and set it to work. It pays for itself in two to three months.

Price, \$60 with bulb.

Send for our Charger booklet.

**BURTON & ROGERS MFG. CO.**  
755 Boylston St. Boston, Mass.

**LATEST "COAST TO COAST" FULLY GUARANTEED**

**RADIO'S-10 DAYS FREE TRIAL  
SAVE 1/3 TO 1/2**

Users everywhere report Miraco Radios get programs coast to coast on loud speaker! outperform sets three times as costly. Many beat foreign countries. Radio's most amazing values in unconditionally guaranteed, factory-built long distance sets—let testimony of users convince you.



**MIRACO  
RADIO  
GETS 'EM  
COAST TO  
COAST**

Powerful New Multi-tube Miraco gets long distance on loud speaker. Set ONLY \$27.35 retail

FREE! Literature on latest improved 1 to 5 tube models, new low prices, testimony of users and SPECIAL OFFER. Write: **MIDWEST RADIO CORP'N**  
Pioneer Builders of Sets  
406-W E. 8th St. Cincinnati, O.

**AGENT  
USERS  
WANTED**  
Write for  
discounts.

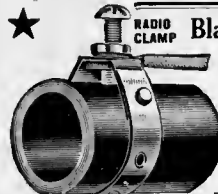

**Blackburn Ground Clamps**

Telephone companies using MILLIONS. Adjustable—fits any size pipe. Requires no pipe cleaning—screw bores through rust and scale. Send 12 cents for sample and postage.

Blackburn Specialty Company  
1960 E. 66th St. Cleveland, O.

**"A Better Condenser"**



The TOBE DEUTSCHMANN High-Voltage Bi-Pass Condenser in its silvered, shielded metal case is designed for all usual bi-pass work in radio receiving-sets, and for construction of "B" eliminators of the Raytheon and other types.

0.10 Mfd. . . \$0.60c.	0.5 Mfd. . . \$0.75
0.25 Mfd. . . \$0.70c.	1.0 Mfd. . . \$0.90
2.0 Mfd. . . \$1.75	

We announce a new TOBE High-Voltage Filter Condenser for strictly filter uses, for power amplifiers and other high-tension work up to 750 volts. Each of these is individually tested and stamped with date of test. Accuracy is guaranteed to within 5% of rating. Put up in heavy metal cases and recommended for precision work. Prices are the same as our former list on filter condensers.

The new TOBE "B" BLOCK is out, for "B" eliminator construction, with one 8 Mfd., two 2 Mfd., and two 1 Mfd. condensers in one case. Saves \$2.50 over cost of separate units,—saves space,—saves wiring.

Send for free eliminator diagrams

**TOBE DEUTSCHMANN CO.**  
Cornhill, Boston, Mass.

**COMO**

**VARIABLE-RATIO  
AUDIO-TRANSFORMER**

4 to 1 - 6 to 1 - 8 to 1

all in one transformer



With this new Como Variable Ratio Transformer the set builder may secure for each stage of audio amplification the exact ratio best suited to the purpose. He may match more closely the primary impedance of the transformer with the plate impedance of his tubes, with a choice of 6 different values.

Built by a pioneer in radio manufacturing, this new Como product will reproduce music and speech with lifelike faithfulness.

In the familiar Como round-top, shielded metal case, at your dealers.

PRICE, \$6<sup>00</sup>

Send for descriptive pamphlet R

**COMO APPARATUS COMPANY, INC.**

Kelley Street

Manchester, N. H.

This is a good time to subscribe for

**RADIO BROADCAST**

Through your dealer or direct, by the year only \$4.00

DOUBLEDAY, PAGE & CO.

GARDEN CITY, NEW YORK

**ARE YOU THE MAN**

to be first in your town to sell and demonstrate POWEROLA, the famous 5-tube, no battery ELECTRIC LIGHT SOCKET RADIO RECEIVER (not an attachment), universal for D. C. or A.C. (100-115 v. 40-60 cycle,) three now sold and demonstrated by THE NEW YORK EDISON CO., public utility companies and radio, electric and music dealers everywhere. Absolutely dependable, fully guaranteed, powerful, practical, perfect in performance. Tested and endorsed by Popular Radio, Radio Broadcast, Radio News, all leading authorities and engineers of your local electric light company.

**Are You the Man Who Sees Opportunities Ahead for Real Money Making?  
YOU, TOO, CAN MAKE POWEROLA**

Send \$1.00 for wiring diagrams showing parts used and how to make any set or circuit (1 to 8 tubes) operate satisfactorily without A, B or C batteries, from A. C. or D. C. This is the newest and greatest proposition in radio.

Write for literature, terms and prices at once

**THE POWEROLA RADIO CORP., 1845 BROADWAY, NEW YORK CITY**

# AMPLION

Product of  
38 Years'  
Experience



## For Better Radio Reproduction

"I have listened to many loud speakers, but never to any music which can compare with that reproduced by the Amplion. The sound is clear, sweet and well modulated. It brings in clearly instruments in bands and orchestras that were lost in other speakers. Through my Amplion I enjoy my radio to a degree I had never thought possible."

You will be as appreciative as this gentleman, once you hear your set through an Amplion. Creation of the originators and oldest makers of loud speaking devices—Alfred Graham & Co., London, England—The Amplion leads in popularity throughout the world.

Enjoy an Amplion demonstration at your dealer's. Six models, including phonograph units, equipped with cords and panel plugs, \$12 up. Write for the "Amplion Pedigree."

★

**THE AMPLION CORPORATION  
OF AMERICA**  
Suite L, 280 Madison Ave., New York City  
Chicago Branch: 27-29 N. Morgan St.  
Burndep of Canada, Ltd., Toronto

## WHAT OUR READERS WRITE

### Naval Radio

PROFESSOR MORECROFT'S comments on the Naval Radio Service in the December RADIO BROADCAST created quite a considerable amount of interest. This especially interesting letter from a gentleman apparently in an excellent position to criticize, should be read in conjunction with Professor Morecroft's remarks elsewhere in this number.

Editor, RADIO BROADCAST,  
Doubleday, Page & Company,  
Garden City, New York.

SIR: After a long month of waiting for your December issue to reach the Coast, I was successful in obtaining a copy today.

After reading Prof. J. H. Morecroft's article about the Naval Radio Service I decided that an answer to a few of his statements and questions was in order.

Just a year ago on the 22nd of this month, I was discharged from the Naval Radio Service. At the time of the *Honda* disaster I was on the U. S. S. *Sumner*, No. 333, 12th Squadron of the Pacific Destroyer Force. My log was used at the hearing which was held at North Island and I know it was through no fault of radio that the disaster occurred. If Mr. Morecroft had looked this matter up more carefully before his writing, he would not have made such a statement.

As for the California-Hawaii flight Mr. Morecroft states: "According to the planes commander, a perfect landing on the ocean was made and nothing happened to interfere with the radio apparatus performing as it was intended to do. Why didn't it perform?" The generators for the radio are wind driven therefore a plane must do her working before landing. Also the transmitting antenna is reeled in before landing. It is a known fact that these planes could not carry the extra weight necessary to transmit while on the water. Of course we all have some ideas of 'How it should have been done' but put yourself in their position and you will see it different. All possible space was needed for fuel, etc., and fuel is heavy—so are batteries, or other equipment necessary for transmission while a plane is down.

Very truly yours,  
H. A. HALCOMB.  
San Diego, California.

### Standardization of Radio Parts

THE need for universal standardization of radio parts is still very general, but much progress in this matter has been made since the inception of broadcasting. The subject was revived in a recent letter to this office, and we would like the comment of our readers on this matter.

ASSOCIATED MANUFACTURERS OF ELECTRICAL SUPPLIES, CHICAGO, ILLINOIS

Editor, RADIO BROADCAST,  
Doubleday, Page & Company,  
Garden City, New York.

SIR: Every one in the radio industry realizes that standardization of radio parts and sets is necessary to bring about a more stabilized condition. The A. M. E. S., which has brought about the



## FREE!

To Each Purchaser of a **WORLD 6 V. Auto or Radio BATTERY**

### 12-Cell — 24-Volt Storage 'B' Battery

Positively given free with each purchase of a WORLD "A" Storage Battery. You must send this ad with your order. WORLD Batteries are famous for their guaranteed quality and service. Backed by years of successful manufacture and thousands of satisfied users. Equipped with Solid Rubber Case, an insurance against acid leakage. You save 50 per cent and get a **2-Year Guaranteed** ★

**Bond in Writing** Approved and Listed as Standard by Leading Authorities including Radio News Laboratories, Popular Science Institute of Standards, Popular Radio Laboratories, Radio Broadcast Laboratories, Radio in the Home, and Lefax, Inc.

"Sell their friends." That's our best proof of performance. Send your order in today.

**Solid Rubber Case Radio Batteries**

6-Volt, 100-Amperes . . . . .	\$11.25
6-Volt, 120-Amperes . . . . .	13.25
6-Volt, 140-Amperes . . . . .	14.00

**Solid Rubber Case Auto Batteries**

6-Volt, 11-Plate . . . . .	\$11.25
6-Volt, 13-Plate . . . . .	13.25
12-Volt, 7-Plate . . . . .	16.00

**Send No Money** Just state battery wanted and we will ship day order is received, by Express C. O. D., subject to your examination on arrival. **FREE "B" Battery included.** Extra Offer: 5 per cent discount for cash in full with order. Buy now and get a guaranteed battery at 50 per cent saving to you.

**WORLD BATTERY COMPANY**  
1219 So. Wabash Ave., Dept. 24 CHICAGO, ILL.

## World

**STORAGE BATTERIES**

Set your Radio Dial at 210 meters for the new 1600 watt World Storage Battery Station, WSBG, Chicago. Watch for announcements.

KDKA — WEAZ — WGN — WJS — KHJ — KGO — KEAF — WJY — KOL

## RADIO AGENTS WANTED

You Can Now Earn a  
**5 Tube Demonstrator FREE!**

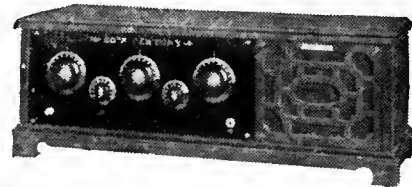

In addition to \$25 to \$100 a week, part or full time. Everyone a prospect. Complete line standard sets and accessories, \$5 to \$90. Write today for illustrated catalog and exclusive selling plan for live dealers and community agents. 20TH CENTURY RADIO CO., 1045 Coca Cola Bldg., Kansas City, Mo.

## Wonderful Volume with Cleanness AMPL-TONE

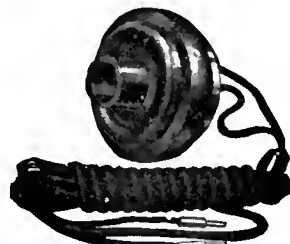

**\$3.00** ★

Phonograph makers have spent years perfecting the acoustic properties of their phonographs. Use an AMPL-TONE Unit and make a real Loud Speaker in an instant or use it in your horn and get better results.

After all, speakers are as good as their unit. We make a real unit at a real price. Money gladly returned if you are not entirely satisfied.

**The UNION FABRIC CO.  
DERBY, CONN.**

Makers of the Excellent French AMPL-TONE Headset  
Please send me an AMPL-TONE Unit for which I enclose \$3.00.

Name.....  
Address.....  
State.....

★ *A Laboratory Product*



### CRESCENT LAVITE RESISTANCES

for Distortionless Amplification.

Used in 50 big broadcasting stations, 12,000, 48,000, 50,000 and 100,000 ohms. For distortionless amplification. Order a Crescent today at \$1.50. Special sizes made to order. Discounts to dealers.

Crescent Radio Supply Co. 11-13 Liberty St., Jamaica, N. Y.

## RADIO RENCH

Five strong little wrenches and a handy screw-driver fitting every nut and bolt on your radio. All held together by a patented device so none will be lost but easily detached for use.



**15¢**

Niagara Metal Stamping Corp.  
Dept. 502, Niagara Falls, N. Y.

Folder Free

## PREMAX

Send Postal Note Prepaid if not a new dealer.

# THE ARISTOCRAT

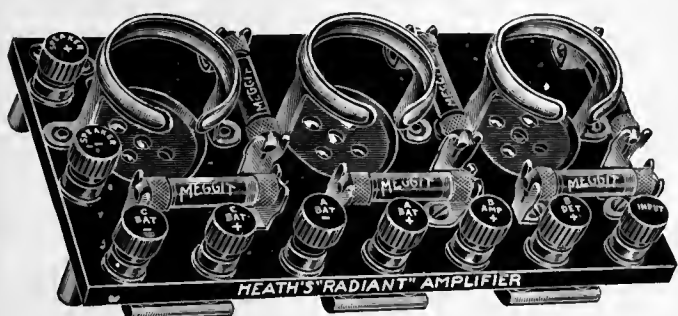

## HEATH RESISTANCE COUPLED AMPLIFIER

Used in Radio Broadcast's Latest Set

Resistance Coupled Amplification has improved radio reception and simplified set construction. For these reasons Radio Broadcast used resistance coupling in the design of their new Aristocrat Receiver. In this wonder set Radio Broadcast recommends the use of Heath's 3-Stage Resistance Coupled Amplifier. The well known quality and performance of Heath's compact, 3-stage unit makes it particularly suitable for any set where full volume and unusual quality are desired.

Write for Literature



Heath Radio and Electric Mfg. Co.

206-210 First Street

Newark, N. J.

# BUS BAR WIRE

Use **COOK'S**

We make a superior wire of pure copper



Every piece of Cook Bus Bar Wire is now plainly stamped "COOK'S"—your protection against substitutes.

It is finished square or round, properly tinned and correctly tempered for radio use.

Furnished in standard lengths of 2 feet.

**EDWARD N. COOK PLATE CO.**

70 Ship Street

Providence, R. I.

Representatives

A. ALLEN SMITH  
304 E. Fourth St., Los Angeles, Cal.

MR. W. I. OTIS  
Rialto Building, San Francisco, Cal.

WOOD & LANE CO.  
915 Olive Street, St. Louis, Mo.

HARRY J. CAFFREY  
51 East 42nd St., New York, N. Y.

## Complete list of GUARANTEED PARTS FOR Silver - Marshall Model 1926

### "MODERN BROADCAST 6-TUBE RECEIVER"

When building this receiver be sure you use only the parts specified and you will have the satisfaction of possessing the finest receiver yet developed.

- 3—S-M 311 .00035 S. L. F. Condensers
- 3—4 in. Kurz Krasch Moulded Dials
- 3—S-M 515 Coil Sockets
- 2—S-M 112A Inductances
- 1—S-M 110A Inductance
- 6—S-M 510 Sockets
- 2—Carter 6-ohm imp. Rheostats
- 1—Central Laboratory 500,000 ohm Modulator
- 3—Daven Resistance couplers complete
- 1—Carter 101 Jack
- 1—Carter 102A Jack
- 1—Carter On-off Switch
- 1—.002 M. F. Condenser
- 2—Dubilier .5 M. F. By-pass Condensers
- 1—7 x 24 Drilled, Sanded and Engraved Bakelite Panel
- 1—7 x 23 Oak Base Board, Bus-bar, Screws, Lugs, etc.
- 1—Belden 5-lead color cable

Complete Parts \$49.50  
as Specified, Only . .  
Wired and Ready to Use \$8. Extra

EXTRAS

Daven MU-20 Tubes	.....	\$ 4.00
Daven MU-6 Power Tube	.....	5.00
Western Electric 540-A.W. Cone Speaker	.....	27.50

All parts carried for Every SILVER-MARSHALL CIRCUIT

WE ALSO CARRY ALL THE PARTS FOR THE

## HAMMARLUND ROBERTS-RECEIVER

Endorsed by Ten Leading Radio Engineers

Engineers of the leading manufacturers who make these parts endorse the operation of the Hammarlund-Roberts Receiver only when it is constructed with these specified units which the designers have found to coordinate most efficiently with one another.

Order from this list and we guarantee you prompt delivery.

Unit No. 1.	2 Rauland-Lyric Transformers	.....at \$9.00	\$18.00
Unit No. 3.	2 Hammarlund .0005 mfd. Model "C" or S. L. F. Condensers	.....at 5.00	10.00
Unit No. 2.	1 Hammarlund "Midget" Condenser 5 plate, 16 mfd.	.....at 1.80	1.80
Unit No. 4.	1 Set Hammarlund-Roberts Coils	.....at 7.50	7.50
Unit No. 5.	2 Na-ald "Super DeLuxe" 4 in. Bakelite	.....at .75	1.50
Unit No. 6.	5 Na-ald "DeLuxe" Sockets	.....at .75	3.75
Unit No. 7.	1 Na-ald K3844—1 1/4 in. Dial	.....at .20	.20
Unit No. 10.	1 Carter 25-ohm "Imp" Rheostat	.....at 1.00	1.00
Unit No. 11.	1 Carter Single Circuit No. 101 "Hold-Tite" Jack	.....at .70	.70
Unit No. 12.	1 Carter "Imp" Battery Switch	.....at .65	.65
Unit No. 16.	1 Durham Metallized Resistor	.....at .40	.40
Unit No. 8.	4 Amperites No. 1-A	.....at 1.10	4.40
Unit No. 13.	1 Dubilier Type 640-G .00025 mfd. Grid Condenser	.....at .50	.50
Unit No. 14.	1 Dubilier Type 640 .002 mfd. Fixed Condenser	.....at .45	.45
Unit No. 15.	1 Dubilier Type 640 .006 mfd. Fixed Condenser	.....at .80	.80
Unit No. 9.	5 Prs. Union Phone Tip Jacks, per pair	.....at .25	1.25
Unit No. 17.	1 Hammarlund-Roberts Foundation Unit (contains engraved bakelite-Westinghouse Micarta panel, drilled bakelite sub-panel metal brackets and wire	.....at 7.90	7.90

Complete Parts as specified \$57.50  
Hammarlund De Luxe Cabinet \$12.  
Wired and Ready to Use \$10. Extra

## General Radio UNIVERSAL RECEIVER

This is the simplified 4-tube circuit described in detail in the January issue of this magazine. Diagrams and complete instructions furnished with each complete set of parts.

Complete Parts \$38.50

Mail orders shipped same day received

**HEINS & BOLET**  
46 PARK PLACE, NEW YORK

for  
radio  
aerials  
—COPPER  
wire



COPPER combines  
the essential  
qualities of—

resistance to cor-  
rosion,  
tensile strength,  
high conductivity.



COPPER & BRASS  
RESEARCH ASSOCIATION

25 Broadway, New York

Order your copy of *Radio Broadcast* from your news dealer or radio store. Make sure that he reserves a copy for you each month. If your favorite radio store does not stock the magazine write us giving name of radio dealer and address.

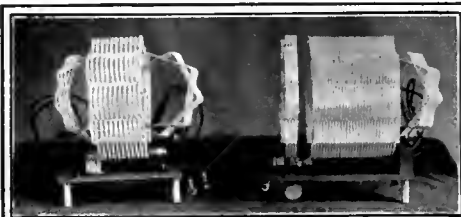

LOW LOSS

Tuners and Coils for all circuits

3 Circuit Amateur and Broadcast Tuners .....\$7.00  
Radio Frequency Transformers (each).....\$2.00  
Coils to order. Write for literature.

Davenport Radio Laboratories ★

1711 W. Locust Street

Davenport, Iowa

standards in the electric light and power field, have created a Radio Section to standardize radio sets and parts.

The Radio Section so far has made wonderful progress in radio standards, but before going further, it is considered advisable to get as much information as possible as to what should be standardized. Some of the things we have in mind that should be standardized at once are as follows:

1. Should Rheostats, Condensers, etc., be of the one-hole mounting type, or mounted by means of screws?

2. Should Dials and Condensers be so designed that when the dial is turned to the right the numbers on the dial increase, or should the numbers increase when the dial is turned to the left?

It seems to us that inasmuch as rheostats turn from left to right, that the other controls should turn in the same direction. There are many sets and condensers on the market on which the dials turn from right to left. It would seem that if this could be standardized it would be a step in the right direction.

3. Should all Dials and Knobs have the same size Holes, and if so, what size do you recommend?

4. How far should Condenser Shafts project through the panel?

There seems to be no standard length of condenser shaft, which results in much annoyance, due to the fact that dials do not fit properly.

The Radio Section has already standardized such items as Cords, Cord-tips, Plugs, Jacks, Rheostat Shafts, Standard Color Code for wiring sets, etc.

What other specifications, in your opinion, should be standardized?

Your recommendations will be beneficial and we will greatly appreciate any assistance or suggestions you care to give.

Very truly yours,

A. J. CARTER.

Chairman, Parts Committee Radio Section.

A Letter from Chicago's "Miss Radio"

BEFORE the commencement of the recently concluded International Tests, RADIO BROADCAST appointed listening posts all over the country so that the fullest possible data could be collected on this subject after the Tests were completed. One of our letters was sent to Chicago's "Miss Radio," and here is her reply.

Editor, RADIO BROADCAST,  
Doubleday, Page & Company,  
Garden City, New York.

Sir:

I would like very much to be appointed as an official listening post for the International Radio Broadcast Tests. I have a certificate of reception awarded to me last year for the successful reception of programs as broadcast from 2 Lo and FTTT, Paris.

I am using an Atwater Kent-10, an Atwater Kent-20, and an Apex Super-Five. I have three different antennas; (1) 140 feet long, south to north; (2) 100 feet long, east to west; (3) 50 feet long, north to south. I have logged 264 different broadcasting stations, and am still going strong. The Atwater Kent-10 was my first set, and was bought in March, 1924.

I was awarded second prize in the "Radio Diana" contest conducted by the Radio World's Fair in New York City, and was awarded first prize in the "Miss Radio" contest at the Chicago Radio Show. I hope to have a five-watt short-wave transmitter going soon.

Very truly yours,

FLOSSIE E. ERICKSON,  
Bloomington, Illinois.

NEW MODEL "T" CABINET

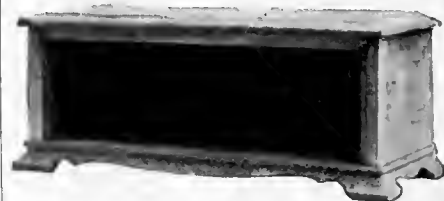

Sizes in stock. Have piano hinge, and are full 8" and 10" deep inside.

Size	Mahogany Finish	Mahogany or Walnut	Size	Mahogany Finish	Mahogany or Walnut
7x18-8	\$8.55	\$9.50	7x13-10	\$10.20	\$11.55
7x21-8	9.30	11.50	7x21-10	10.90	13.25
7x24-8	10.10	12.60	7x24-10	11.70	14.65
7x26-8	10.70	13.35	7x26-10	12.65	15.80
7x28-8	11.80	14.70	7x28-10	13.00	16.20
7x30-8	12.75	15.85	7x30-10	13.30	16.65

HAMMARLUND ROBERTS CABINET

With piano hinge, sloping panel, and fancy line grooves.  
Mahogany or Walnut.....\$14.00  
Mahogany Finish..... 11.50

BROADCAST UNIVERSAL AND ARISTOCRAT CABINETS

Model T design, with slots and drilling to specifications  
Mahogany or Walnut.....\$11.00  
Mahogany Finish..... 9.00

Shipping charges prepaid

"CORBETT'S CABINETS" have been preferred for several years by quality set builders and are unquestionably superior in design and finish. They are backed by our guarantee to please you. Carefully hand-rubbed piano finish. Well packed for shipment.

WRITE FOR CATALOG showing attractive models for all sizes of radio cabinets, consoles and tables.

Jobbers and Dealers write for discounts. ★

CORBETT CABINET MFG. COMPANY  
St. Marys Pennsylvania



NO MORE LOOSE CONNECTIONS  
X-L PUSH POST

A Binding Post that really does excel, looks action, service and convenience. Push it down—insert wire—cannot jar loose from vibration. No screwing or danger of shearing off wires. Furnished attractively plated with soldering lug and necessary markings.

Price Each, 15 Cents

X-L RADIO LABORATORIES  
2424 Lincoln Ave. CHICAGO

Why not subscribe to *Radio Broadcast*? By the year only \$4.00; or two years, \$6.00, saving \$2.40. Send direct to Doubleday, Page & Company, Garden City, New York.

FOR CLEAR, QUIET "B" POWER



RADIO Storage "B" Battery

12 Cells 24 Volts Lasts Indefinitely—Pays for Itself

Economy and performance unheard of before. Recharged at a negligible cost. Delivers unfailing power that is clear, pure and quiet. Approved and listed as Standard by leading Radio Authorities, including Pop. Radio Laboratories, Pop. Sci. Inst. Standards, Radio News Lab., Lefax, Inc., and other important institutions. Equipped with Solid Rubber Cases, an insurance against acid and leakage. Extra heavy class jars. Heavy rugged plates. Order yours today!

SEND NO MONEY Just state number of batteries wanted and we will ship day order is received. Extra offer: 4 batteries in series (93 volts), \$10.00. Pay exp. salesman after examining batteries. 5 per cent discount for cash with order. Mail your order now!

WORLD BATTERY COMPANY  
1219 So. Wabash Ave., Dept. 78 Chicago, Ill.  
Makers of the Famous World Radio "A" Storage Battery  
Prices: 6-cell, 100 Amp. \$11.00; 12-cell, 120 Amp. \$13.25; 14-cell, 140 Amp. \$16.00.  
All equipped with Solid Rubber Cases.

World STORAGE BATTERIES

Set your Radio Dials at 210 meters for the new 1000 watt World Storage Battery Station, WSB, Chicago. Watch for announcements.

KDKA-WFAP-WGN-WJIS-KLU-KGO-KTAE-WA-210





**Oh boy!**

**KESTER**  
Rosin Core  
**Radio SOLDER**  
Sure! is Safe and Simple

Approved by  
**Radio Engineers**  
A Genuine Solder

CHICAGO SOLDER COMPANY  
4222 Wrightwood Ave., Chicago, U.S.A.

Originators and  
World's Largest Manufacturers of  
Self Fluxing Solder

YOUR DEALER  
CAN SUPPLY YOU

★

**A&B Battery \$2**  
**Charger ONLY**

SATISFACTION GUARANTEED



Charges any type of storage A or B battery, or auto battery, using a few cents worth of ordinary house current. Cannot injure battery and lasts for years. Complete directions enclosed—anyone can operate. No "Extras" to buy.

Why pay \$10.00 to \$18.00 for a charger when you can get this splendid GUARANTEED R. B. Charger by mailing us two dollars (bills, money order, check, or stamps). Charger will be sent postpaid. Act at once. TO-DAY.

**R. B. MANUFACTURING CO.**  
308 East Third Dept. 19 Cincinnati, Ohio

# RADIO PEP

**B-BATTERY ELIMINATOR**  
**NO TUBES** **NO HUM**



**Buy no more B-batteries!**

**USE** the unlimited supply of cheap, dependable electricity right at hand in your house-lighting circuit.

This can be done with *permanent* satisfaction with **RADIO PEP**.

**RADIO PEP** is the **FIRST** eliminator to completely solve the problem, as it is the only one made with **EIGHT PERFECTED ELECTROLYTIC CELLS**, replacing tubes and doing away with all the familiar tube troubles.

Two or four cells *overloaded* will not give **PERMANENCE** and **POWER**—the outstanding characteristics of **RADIO PEP**.

**135 VOLTS** are called for by the modern sets and tubes; here you get it year after year without weakening.

For 110-125 volts, 60-cycle alternating current.

*Send for particulars and name of our nearest dealer. Price \$38. Money back guarantee.*



**PEP MFG. CO., Inc.**

33 West 42nd Street

New York

# RADIO BROADCAST

ARTHUR H. LYNCH, Editor  
WILLIS K. WING, Managing Editor  
JOHN B. BRENNAN, Technical Editor

APRIL, 1926  
Vol. VIII, No. 6

## CONTENTS

Cover Design	From a Painting by Fred J. Edgars	
Frontispiece	Listening-in at Peking	642
How Radio Grew Up	Robert H. Marriott	643
What Happened During the 1926 International Tests	Willis K. Wing	647
The March of Radio	J. H. Morecroft	652
The \$500 Short-Wave Receiver Contest		657
The Tube and Its Best Uses	Keith Henney	658
The "Aristocrat" Receiver		664
Radio Sets for Light Keepers		666
The Listeners' Point of View	John Wallace	667
As the Broadcaster Sees It	Carl Dreher	672
	Drawings by F. F. Stratford	
How a Portable B Battery Transmitter Works	By the Laboratory Staff	678
The Use of the Filament Resistance	John B. Brennan	682
Cutting out the Locals	H. E. Rhodes	686
The Grid—Questions and Answers		696
	Coil Dimensions for the "Universal" Receiver Eliminating the Reflex in the Roberts Circuit How to Calculate Capacity in Series or Parallel A Three-Tube R. F. Circuit with Impedance Amplification	
"Now, I Have Found"		702
	Improving Reproduction in Cone Speakers How to Provide a Counterpoise System The Silver "Model 1926 Receiver" A Coil Winder for Diamondweave Coils A Battery Throw-over Switch Economical Sub-panel Brackets	
Short Wave Stations of the World		708
A Key to Recent Radio Articles	E. G. Shalkhauser	710
What Our Readers Write Us		716

## BEHIND EDITORIAL SCENES

ROBERT H. MARRIOTT is one of the "old men of radio" in the United States and his articles about "How Radio Grew Up" seem to please both old and new radio folk. The first article in the series he is writing for RADIO BROADCAST appeared in December, 1925. However much we may marvel now at the accomplishments of the amateur in throwing a faint short-wave signal half way around the world with his simple apparatus, there is still much of the remarkable in the accomplishments of the early radio workers, and there is no one better able to tell about it than Mr. Marriott. There are other articles to follow by him.

ALTHOUGH the International Tests are considerably behind us in this rapidly moving radio world, the correspondence from radio listeners all over the United States and from foreign countries still continues to bombard the office. For those who listened in vain for a peep on a foreign wavelength, the review of the results of the Tests on page 647 of this issue should attract attention. A letter just received from a woman in Iowa is especially interesting. "To settle an argument with my husband," she writes, "will you please tell me whether or not the following program came from any foreign station?" The program in question came from Bournemouth, and since that station was added to the list at the last minute, she, among many listeners, did not know they were on. We settled the argument.

THE third in the series of Keith Henney's valuable articles on tubes appears in this number. The previous two appeared in the December and February issues of RADIO BROADCAST. "The Tube and Its Best Uses" is specially designed to answer all sorts of questions on the practical use of the tube in radio circuits, and it was written in a large measure to answer definite inquiries which came to our office.

COMING numbers of RADIO BROADCAST will have much of interest to every sort of reader. One wishes that space limitations did not prevent us from including in this issue some of these articles which have been omitted for that reason. In an early number, there will be another of the home laboratory articles, describing a very useful wavemeter with complete instructions on how to use this valuable device in the home laboratory. Then there is another article by H. E. Rhodes on wavetraps, describing a number of valuable types, which will be a great help to those who are having their own difficulties with a receiver which is not selective enough. There will be more information on short-wave transmitters—that subject which has proved widely popular with our readers. Edgar H. Felix has written a very helpful article on how to learn the code which many a mystified struggler with the Continental dots and dashes will find of great value. The article by J. C. Jensen in the April number, "Can We Forecast Radio Reception from the Weather?" has stirred up no end of interest and discussion. Shortly after the magazine appeared, the Associated Press carried a story about Mr. Jensen's conclusions. Mr. Jensen's article has inspired other investigators in the same field to tell us of their work and we hope soon to print the conclusions of some of these men.

MANUSCRIPTS on the \$500 short-wave receiver contest are piling into the office, and those who have not yet become actively interested in the problem should turn at once to page 657 and set their brains to work.—W. K. W.

### Doubleday, Page & Co. MAGAZINES

COUNTRY LIFE  
WORLD'S WORK  
GARDEN & HOME BUILDER  
RADIO BROADCAST  
SHORT STORIES  
EDUCATIONAL REVIEW  
LE PETIT JOURNAL  
EL ECO  
THE FRONTIER  
WEST

### Doubleday, Page & Co. BOOK SHOPS

NEW YORK: LORD & TAYLOR BOOK SHOP  
PENNSYLVANIA TERMINAL (2 SHOPS)  
38 WALL ST. AND 166 WEST 32ND ST.  
GRAND CENTRAL TERMINAL  
ST. LOUIS: 223 NORTH 8TH STREET  
4914 MARYLAND AVENUE  
KANSAS CITY: 920 GRAND AVENUE  
306 WEST 47TH STREET  
CLEVELAND: HIGBEE CO.  
SPRINGFIELD, MASS.: MEEKINS, PACKARD & WHEAT

### Doubleday, Page & Co. OFFICES

GARDEN CITY, N. Y.  
NEW YORK: 285 MADISON AVENUE  
BOSTON: TREMONT BUILDING  
CHICAGO: PEOPLES GAS BUILDING  
SANTA BARBARA, CAL.  
LONDON: WM. HEINEMANN LTD.  
TORONTO: OXFORD UNIVERSITY PRESS

### Doubleday, Page & Co. OFFICERS

F. N. DOUBLEDAY, President  
A. W. PAGE, Vice-President  
NELSON DOUBLEDAY, Vice-President  
RUSSELL DOUBLEDAY, Secretary  
S. A. EVERITT, Treasurer  
JOHN J. HESSIAN, Asst. Treasurer

DOUBLEDAY, PAGE & COMPANY, Garden City, New York

Copyright, 1926, in the United States, Newfoundland, Great Britain, Canada, and other countries by Doubleday, Page & Company. All rights reserved.  
TERMS: \$4.00 a year; single copies 35 cents.



# Ferguson

J. B. INCORPORATED

*The Gold Standard of Radio Receivers*



AS THE "FORTY-NINERS" washed out for the hidden particles of gold, so, today, the wise buyer—sifting through a confusion of extravagant claims and choosing on performance alone—finds Ferguson, "The Gold Standard of Radio Receivers."

Readily piercing through the maze of local broadcasters, the Ferguson unfailingly finds the more remote stations. Its three stages of *Matched Audio* give ample volume so that you may not only hear but enjoy their programs. Its life-like reproduction is true as gold.

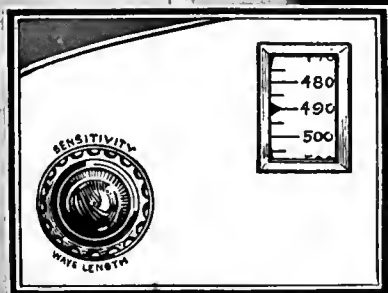

**One Tuning Control—  
Calibrated in Meters!**

Select your program, turn up its wavelength and in comes your station. In accomplishing this feat in radio design, there has not been the slightest sacrifice in electrical efficiency.

*Arrange with the nearest Authorized  
Ferguson Dealer for a demonstration  
in your own home, or write us.*

**J. B. FERGUSON, Inc.**  
41 East 42d Street  
NEW YORK, N. Y.

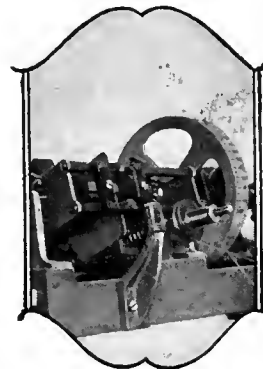

*The single tuning knob revolves the shaft by means of a split gear that eliminates all backlash. A pivot bearing gives this control its velvet-smooth ease. The Receiver is mounted upon a rigid aluminum chassis.*



CABINET MODEL EIGHT  
A Six-tube Tuned r. f. Receiver, \$226

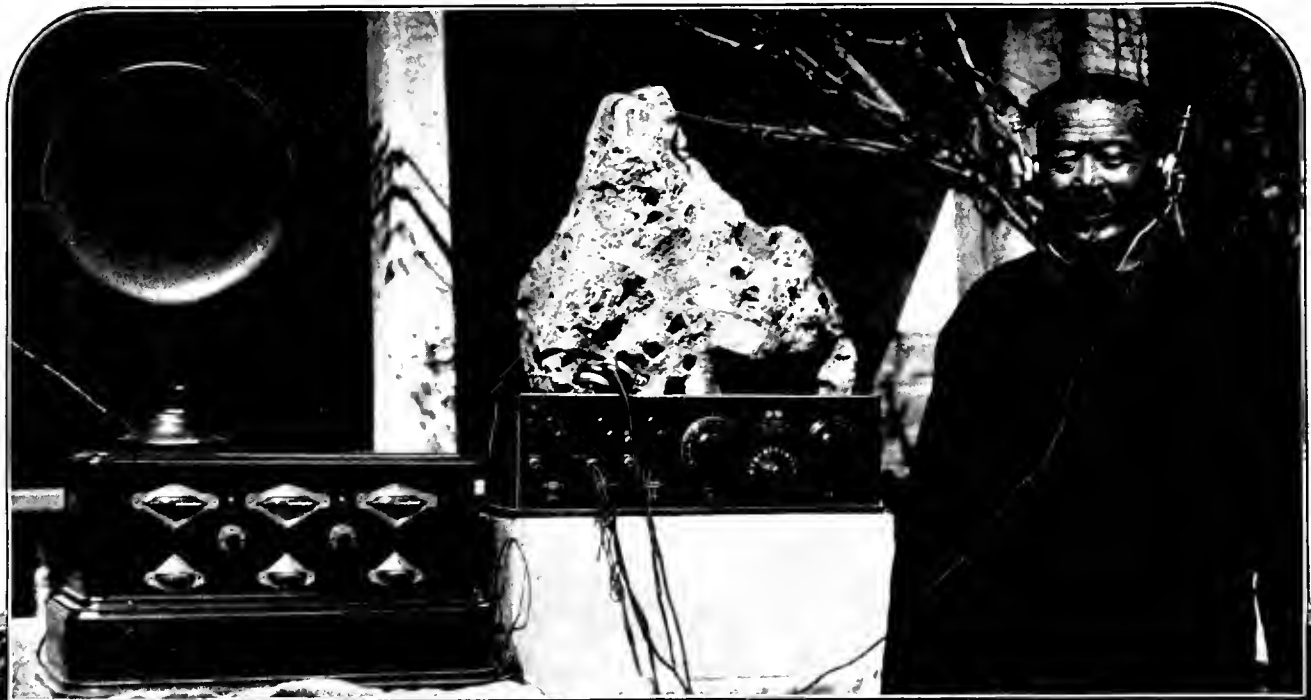

### LISTENING-IN AT PEKIN

© American Museum of Natural History and *Asia*

Although radio broadcasting has already made its debut in some Chinese centers, most of the natives listening-in here were doing so for the first time. The sets are those of the scientific expedition headed by Roy Chapman Andrews, which was sent to Mongolia through the cooperative efforts of the American Museum of Natural History, and *Asia* magazine. The upper picture shows one of the expedition mystified by the voice in the box, while the other retainers are shown listening to a program from Tientsin in the lower picture

# RADIO BROADCAST

VOLUME VIII



NUMBER 6

APRIL, 1926

## How Radio Grew Up

The Period 1872 to 1897—Hughes, Dolbear, Hertz, Branley, Lodge, Tesla, Popoff—Marconi's Early Life—Wireless is First Put on a Commercial Basis

By ROBERT H. MARRIOTT

*First President, Institute of Radio Engineers*

**I**N CHAPTER I of "How Radio Grew Up" we rapidly traced the growth of radio science from its earliest stages—from the time when Luigi Galvani conducted his researches in 1790, probably knowing little about what he was actually doing, through the researches of De Salva, of Morse, and of Maxwell. The electro-magnetic induction experiments of Faraday were also described, and the story concluded with one Loomis, who, in 1872, took out a patent for a special apparatus designed to utilize electricity collected from the atmosphere for transmitting purposes. Taking up our story at this point (where it was dropped in the December, 1925, RADIO BROADCAST,) the first new name in the series is that of Professor D. E. Hughes, who, in 1872, managed to transmit and receive intelligible signals over a distance of a quarter of a mile, using, for receiving purposes, both coherers and microphonic detectors.

He described his devices before the Royal Society on May 8, 1878. During his experiments, he walked up and down Great Portland Street in London with his microphonic detector and telephone receiver, and it was at this time that he got signals up to a quarter of a mile or more from his transmitter. Had he persisted with his apparatus, and if it had been possible to employ at that time a present day publicity agent, radio might have gone into public service many years earlier than it did, for some of the accounts indicate that his apparatus was every bit as efficient as apparatus used seventeen years later. In this country we quickly abandoned the later

coherer method of reception and went back to the telephone and detector method.

Hughes made his demonstrations to fellow scientists who appeared to be bent on discouraging him, and years later he said, "I was so discouraged at being unable to convince them of the truth of these aerial electric waves that I actually refused to write a paper on the subject—."

In 1882, Professor A. E. Dolbear, of Tufts College, built a transmitter and a receiver, with antenna and ground, that apparently must have operated according to the electro-magnetic theory. On October 5, 1886, he was granted United States patent number 350,299. He described

his invention as a mode of electric communication, and said in the description, "Communication may thus be established between points certainly more than half a mile apart; but how much farther I cannot now say."

It looks now as though both Hughes's and Dolbear's devices were pretty fair radio devices for that time; but apparently those equipments were not deliberately designed and operated on the basis of the now accepted electro-magnetic wave theory of Maxwell.

Following Hughes and Dolbear, we next come to the exponents of the earlier Maxwell theory. The first of these is Henrich

Hertz, a German scientist, who, in 1886, proceeding on Maxwell's theory, built and used a carefully tuned radio transmitter and receiver. However, it could not be heard enough to do much more than serve as proof of the Maxwell theory, because the detector was insensitive. Sir William Crookes, in discussing Hertz's apparatus, said, quoting from the *Fortnightly Review*, London, February, 1892, "Here, then, is revealed the bewildering possibility of telegraph without wires, posts, cables, or any of our present costly appliances."

HERTZ THE FATHER OF RADIO?

**S**OME scientists and other folk who have studied the history of radio and who are not biased by nationality or by some company's pay roll, are inclined to say that radio is a product of evolution; while others prefer to say that radio was invented. As a rule, those unbiased ones who prefer to say it was invented, give the credit to Hertz.



EDOUARD BRANLY

A French scientist who made a very valuable contribution to wireless telegraphy in designing a detector known as a coherer. It was later improved by Sir Oliver Lodge

the product of German, French, English, American, and Russian scientists, arrived at by sticking to the Scotchman's (Maxwell's) theory.

#### MARCONI'S EARLY LIFE

WHILE this radio development was going on in the scientific circles of the world, young Marconi had been taking a course under science teachers at Leghorn and Bologna, and became interested in radio in 1895, when about twenty-one years old. He had means and influential connections in both Italy and Great Britain. He came from Italian ancestry on his father's side, and Irish ancestry on his mother's side.

In 1896, Marconi went to England and filed a patent in which he described the Hertz-Branly-Lodge-Tesla-Popoff devices and a special form of spark gap that had been designed by the Italian scientist Righi, which gap was not necessary but could be used as a substitute for the one used by Hertz. Then he commenced demonstrating what was actually known about radio up to that time, to government representatives and to business men, to newspaper and magazine writers. His demonstrating extended radio from college environment to political, military, and mercenary circles. By the middle of 1897, business men had become sufficiently interested to form a £100,000 company for exploiting radio.

Marconi played the part of a salesman, and, as is still often the case where scientists and salesmen are involved, the salesman got money out of it while the scientists



GUGLIELMO MARCONI

Whom Mr. Marriott describes as a sales engineer. He studied and conducted his early experiments at the University of Bologna in Italy. In 1899 he succeeded in communicating across the English Channel for the first time, and in 1901, across the Atlantic Ocean. He was awarded the Nobel Prize for Physics in 1909

didn't. Also, as part of the promotion scheme for getting money, Marconi was advertised as deserving the honor for what the scientists had done, making him appear as a profound scientist and almost supernatural inventor.

The scheme was to make it appear that Marconi had invented radio and thereby get a world wide radio patent monopoly. That was the beginning of many duplicated attempts to advertise inventions and inventors for the purpose of getting a monopoly of radio, or to sell stock. It has

been tried more or less right up to this very minute. In the United States, however, the patents were shown up for what they were worth, or avoided by making other devices that would serve the same purpose.

The virtue of the Marconi Company's advertising was in the publicity it gave to radio and not in the claims they made for themselves. That publicity started quite active development of radio in several countries. It put more money and people into the developing of this so-called new science.

The advertising brought radio to the attention of people in all walks of life, including numerous unattached young would-be scientists and engineers, who,



NIKOLA TESLA

Was born in Austria-Hungary in 1857, Serbian by race. It was originally intended that he should be trained for the clergy, but he developed scientific tendencies instead. He came to America in 1884 and immediately entered the Edison works, afterward starting out on his own. In 1893 he invented methods of wireless transmission

In 1891, Edouard Branly, a French scientist, made a more sensitive detector than that used by Hertz, intended for use in the latter's receiver. This detector was called the Branly coherer. It consisted of particles of metal that would stick together when affected by radio currents and would then pass a battery current. Sir Oliver Lodge used the Hertz-Branly combination, but added a tapper that automatically de-cohered the coherer after a signal.

In 1893, Nicola Tesla proposed that high antennas and a ground connection be used at the sending and receiving instruments to get the greatest possible distance.

In 1895 Vladimir Popoff, a Russian, added antenna and ground to the Hertz-Branly-Lodge combination, and gave demonstrations to students and scientific people. The distances covered grew with these successive steps.

By 1894, wireless, that is the induction system like that Faraday had used, and the conduction system which Morse had demonstrated, had been successfully and repeatedly used to telegraph over distances up to three miles or more. The Hertz-Branly-Lodge-Tesla-Popoff combination apparently worked best. It was



THE CATALINA SENDING STATION

Located at Avalon, about twenty-five miles from the California Coast station. Until Mr. Marriott erected this station there was no means of communication with the mainland except by means of the boat service which was not at all reliable, especially in bad weather. One of the first uses to which this wireless was put was to receive the result of a big fight which took place in San Francisco. Skeptics doubted the authenticity of the wireless reports and even after they were confirmed, various theories as to how the messages were actually received were advanced. Some said that carrier pigeons were used. Others said they saw a man in a small boat land on the island with the news. Another theory was that signals by means of powerful lights were sent from the mainland to Catalina

like Marconi, as yet had no scientific or engineering reputations to lose, and therefore, could take a chance in this new field.

It became obvious to many that radio could be useful if properly applied. Its apparent possibilities made it an easy thing for stock jobbers to sell stock in radio companies. They were inclined to depart very widely from the kind of rules laid down in Christian Sunday schools in disposing of their stocks, however. Radio was an obviously fertile field, but without immediate returns in it. It contained some more or less

*first to catch the message and was used for quite a while. While I helped a little in mechanical execution of the device the honor of its introduction is yours.*

*The device was about as follows.*

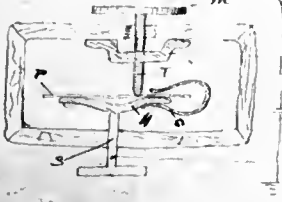

*A holding piece # with a clamp c was mounted eccentrically in relation to the screw m so that when the oxidized plate p was in position held by the clip c a new point on the plate could be secured by turning the shaft s in a circle. A new circle of points could be secured by moving the plate more or less deep into the clip c. It is obvious that after*

AN EARLY DETECTOR

Is shown in this photographic reproduction of the sketch and description of those made by Mr. Swenson (Mr. Marriott's able assistant) to Mr. Marriott's specifications. These were used in the California-Catalina Island circuit for several years. They consisted of converted spherometers

dangerous Indians. Scientists, with reliable incomes and reputations that might get sunk naturally were afraid to go into radio. However, there were quite a number of young men who had been given scientific training, and who had not made any scientific or engineering reputations that could be lost. Some of them were adventurous enough to go into radio then, and a few still survive. The writer is one of these young men.

After 1897, the works and workers became so increasingly numerous that only some of the essence of them can be

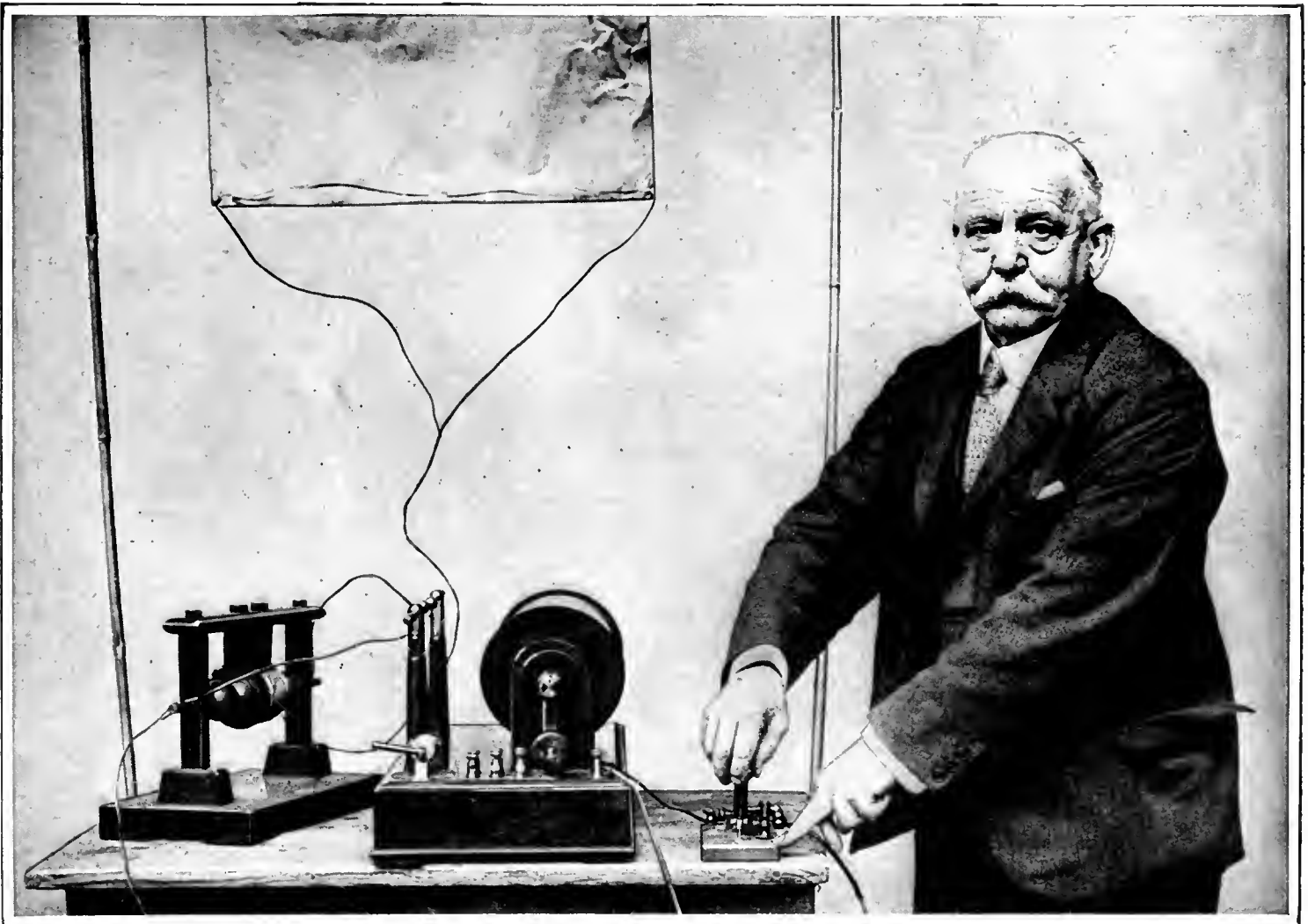

C. S. KEMP, AN EARLY ASSISTANT OF SENATOR MARCONI

Photographed in England with the apparatus used by Mr. Marconi in his experiments at Bologna, Italy, in 1895. The copper plate at the top is the antenna used for short distances, while for greater distances, kite balloons ten feet in diameter with a copper antenna wire attached, were employed. The telegraph key is at the right, the large induction coil shown in the center operating from batteries, furnished the high-frequency energy

given here. Radio stations began to bob up in various parts of the world like mushrooms, and like mushrooms, they did not last long in any one place; as a rule because they didn't pay expenses, and also because a great many of them were temporary stations erected purely for demonstration purposes, devoted to showing the possibilities at that place, or to sell stock. In 1902, the writer succeeded in establishing a radio circuit between Catalina Island and the mainland of California, the first in the United States that stayed put, although several circuits had been tried before that. That circuit continued for twenty-one years, becoming a radio telephone circuit in its later days. The use of telephony killed it, for too many uninvited folks were able to listen-in.

The steamship companies were slow to install radio on their ships. The directors of the companies had too many other places where they wanted to put their money. The captains likewise did not want it because, without it, they were kings between docks, but with it, the owners might play king and give them orders. A large proportion of the first ship radio stations were established on board free of charge to the steamship companies.

The United States law which compelled ships to be equipped with radio, took effect in 1912, and caused a large increase in radio on vessels, and also resulted in some of the old captains recalling for service all the cuss words they had mentally vocabularized during, perhaps, forty years at sea. The writer had intimate contact with this aspect of radio, because, when the law went into effect, he helped enforce it at New York as United States Radio In-

spector. After a captain's big noisy kick was divested of its profane trimmings, about all it amounted to was a statement to the effect that he had sailed the seas ever since the time when vessels were pushed along by the wind, and that he had

gotten along without wireless up to date so why shouldn't he and everybody else continue to get along without it. All the radio inspector had to say was, "Maybe so, but if your radio isn't in proper working order before you leave port I will have to report it, and you will be liable to a fine of five thousand dollars." Not many words, but they were effective.

The value of radio as a protection against the loss of life and property, and the failure of steamship companies to avail themselves of it, made the law necessary. Had there been a radio monopoly, this law would probably have been all the more necessary because the monopoly would have undoubtedly held up the prices, and steamship owners would have fought harder against its enforcement.

The United States took the lead in the production of the best detectors and receivers; Germany took the lead in the production of the best transmitters. Receivers and detectors were inexpensive to build, as compared with transmitters. This was what probably caused the various workers in the United States to advance rapidly in making the best detectors and receivers. By the time the European War started in 1914, however, the United States was catching up with Germany in making first class transmitters.

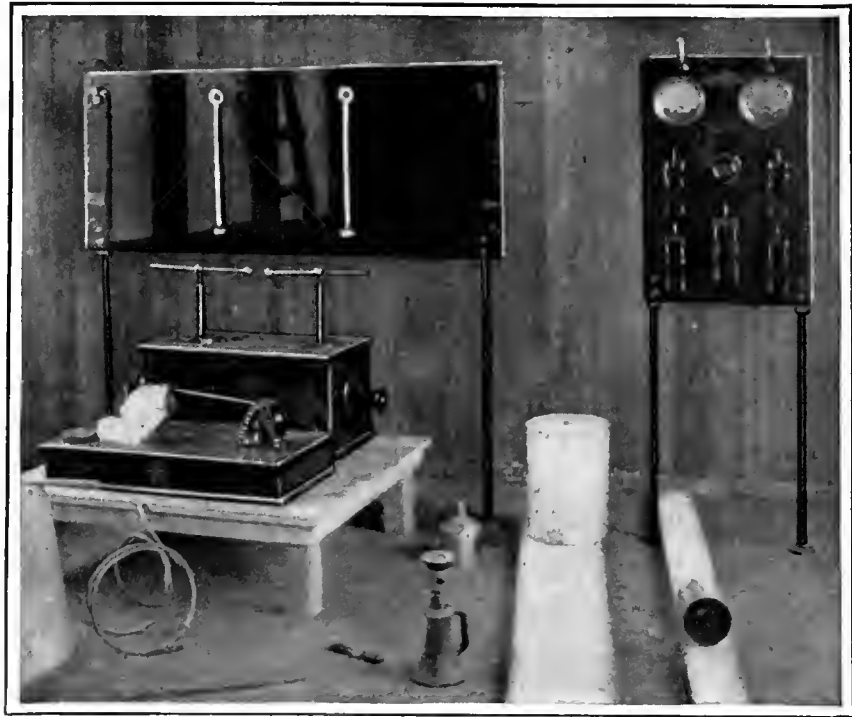

A 1902 COMMERCIAL RADIO CIRCUIT

The wireless telegraph installation at Catalina Island, made by Mr. Marriott and his assistants. The switchboard at the right controlled the dynamo circuits for light and transmitter power. The switchboard in the back carried two remote control switch arms which switched the antenna from "send" to "receive". The box bearing the spark rods is a large induction coil capable of giving a 20-inch spark but actually delivering a  $\frac{3}{8}$ -inch spark when connected to the antenna. The piece of paper covers a mechanical interrupter, which, at the time the picture was taken, was a secret

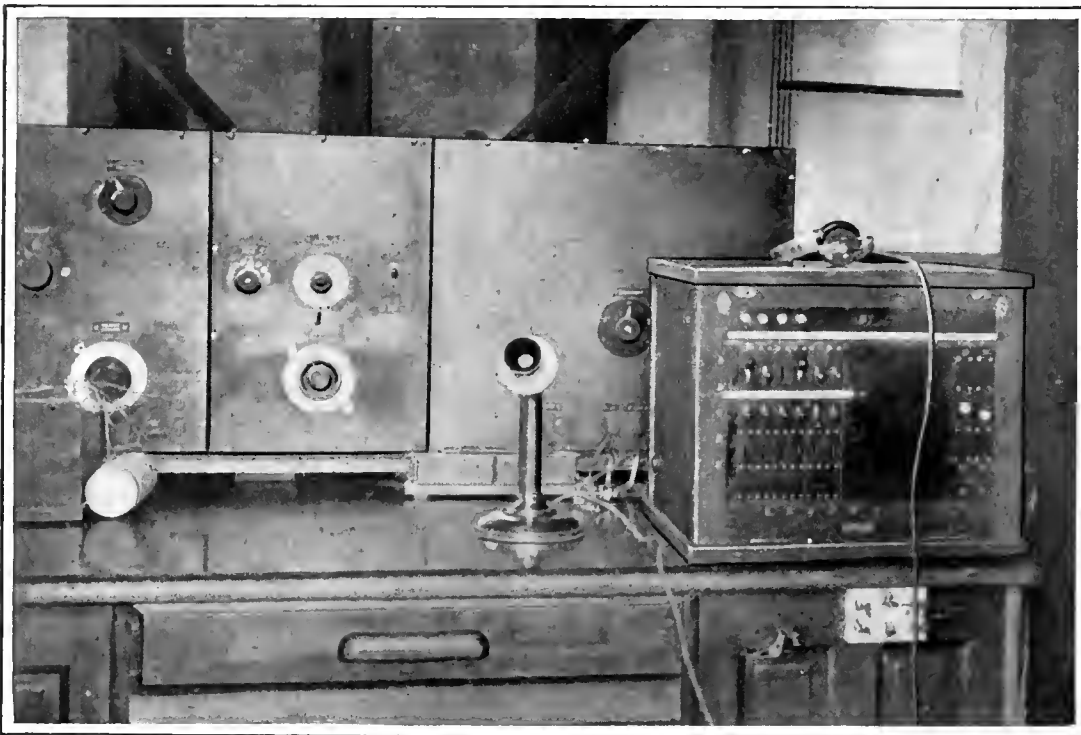

THE RECEIVING EQUIPMENT

Of the last Santa Catalina public service station, which was closed in July, 1923, as its traffic was listened-in to by many outsiders. The receiving loop may be detected in the background. A submarine cable was substituted for the radio link



# What Happened During the 1926 International Tests

*A Complete Report of the Plans, Their Progress and Success—What Stations Were Generally Heard—How Bloopers Spoiled Reception—The Great Popularity of the Regional Broadcasting Experiment*

By WILLIS K. WING

**M**ANY old wives' tales are common knowledge about events which occur in the dark of the moon. And by the same token, things which happen during the full moon must take their chances of success. The third of the International Radio Broadcast Tests took place during the fullest of full moons, we remind the superstitious, and if that be any comfort to those who failed to hear signals from the foreign broadcasters, all of that gentry are free to make the most of that celestial condition. For to review the Tests briefly, a comparatively small number of American and Canadian listeners heard broadcasting stations on the other side of the Atlantic. If that is the only measure of failure, the Tests were a failure. However, the Tests this year, lasting for an hour for seven days, included but five days of transmission from transatlantic stations. The other two days, as everyone knows, were devoted to distance receiving trials on the North and South American continents. And in those two days, the average listener probably heard more stations on this continent than he had ever heard before. The genuinely new feature of the Tests proved a great success.

The plans for the Tests were published so completely in newspapers in this country and in Canada, that there is no point in completely reviewing them here, for no monthly magazine can hope to compete with a newspaper. But the 1926 Tests were the third to be held. The first Test was held in November, 1923, and involved only the stations of the British Broadcasting Company, abroad. The second occurred in November, 1924. In that, the British stations and broadcasters in Spain, Italy, France, and Belgium took part. The third annual Test was to have been held in November, 1925, but was postponed to January, 1926 in order to take advantage of what was fondly supposed to be better weather conditions.

There is always plenty of enthusiasm for international broadcasting from this side of the Atlantic, but the desire for a special Test of this sort is not so great on the other side of the water, and especially in England, where there are probably more active listeners than in any of the Continental countries. Owing to the difference in time, it is possible for any European listener to sit up a bit after twelve at night, and if he has a sensitive receiver, tune-in an occasional American station. So that when the special International Tests are arranged, with listening periods for American stations at from three to four o'clock in the morning, European time, the desire on the part of foreign fans for

special long distance tests is apt to be less ardent than here, where the listening period has never been later than midnight, Eastern time.

## LARGE NUMBER OF STATIONS INVOLVED

**B**UT in spite of these handicaps, the foreign arrangements for the Tests went forward with great completeness and more foreign stations were listed in the schedules this year than have ever taken part before. John Scott-Taggart, editor of the British Radio Press publications was appointed foreign director of the Tests, and through his good offices and those of his able assistant, Percy W. Harris, editorial manager for those publications, the work went forward. On the Continent, the arrangements were in charge of Dwight K. Tripp, a former member of the editorial staff of RADIO BROADCAST, who is now residing in Paris. Mr. Tripp worked in close coöperation with Arthur Burrows, head of the newly formed Bureau International de Radiophonie at Geneva.

Although the engineers of all the Continental broadcasting stations have, for the past few months, been conducting some special late broadcasting tests of their own, in the effort to solve the problem in international heterodyning between stations which is now very serious, they entered into the spirit of the plan and assumed the additional burden of broadcasting for an hour several nights of the Test at the unpleasantly early hour of four o'clock in the morning, their time. It was chiefly through the fortunate official influence of Mr. Burrows that the Con-

tinental coöperation was as general and complete as it was. And Mr. Tripp was untiring in his efforts to make the many complicated arrangements necessary.

On this side of the Atlantic, the greatest number of broadcasting stations ever to take part in a concerted plan of this sort were on the schedule. There were the 37 Canadian broadcasting stations, some 550 American broadcasters, 16 Mexican stations, 36 Cuban broadcasters, one station in Porto Rico, one in Lima, Peru, and three in Argentina taking part. The coöperation of the Cuban stations was secured by Mr. Frank H. Jones, owner of station 6KW at Tuinicu. The coöperation of the American broadcasting stations was practically complete with the exception of several of the California stations, notably KNX at Hollywood and KFI at Los Angeles. The operators of KFI it was announced, felt that their individuality would be greatly limited by participation in the Tests and confidently undertook to analyze the desires of all the radio listeners within range of their five kilowatts, and decided, to the tune of wide publicity, that they would remain on the air during the silent periods. They stated that the chances of California listeners for hearing foreign broadcasting was very slim, and to that confident assertion was added the confession that theirs was in part a commercial station, devoted to selling time on the air, and that they saw no reason for making any financial sacrifice.

Our records show that a number of listeners in Oregon and Washington did hear fragments of the foreign programs, a remarkable receiving record. A very large number, comparatively speaking, heard OAX at Lima, Peru and several of the Buenos Aires stations. The sentiment quoted from the letter printed below is similar to that contained in a great many letters and telegrams which came into the office of RADIO BROADCAST both during and after the Tests.

Editor, RADIO BROADCAST,  
Doubleday, Page & Company,  
Garden City, New York.

SIR,  
I am a radio dealer and a fan as well. May we not in some way enter protest against California stations remaining on the air during the quiet hour Sunday night (January 24th) during the Tests? I think I picked them all up. I like California, but I like them to shut up at least once a year and I am sure I speak the sentiments of many more of your readers and fans in this locality.

Very truly yours,  
W. M. CURTRIGHT,  
Flat River, Missouri.

No purpose would be served in



THE SHORT-WAVE OUTFIT IN USE AT 2GY

During the International Tests, a 40- and an 80-meter transmitter were used constantly in checking receiving conditions with amateur operators in this country and in Europe. Many reports of reception were handled by this short-wave link

embroidering this controversy, except to add, in fairness to the Pacific Radio Trade Association, who failed to cooperate positively in the national United States arrangements, that they finally agreed to recommend silence for the West coast stations even though they were in highly active opposition to the plan. And during the first few nights of the Tests, some of the Pacific coast stations did not keep silence, but in the main, their insurgent tactics caused no national radio calamity. Our judgment that radio listeners there, and elsewhere, wanted the Tests to go through as planned, whether or not the individual felt he had a chance of hearing Europe, has certainly been vindicated if our heavy correspondence is any criterion.

#### HOW THE TESTS WERE ADMINISTERED

**T**HE Tests were managed this year by a representative organization, drawn from all branches of the radio industry. A committee was chosen from the National Radio Trade Association, with Powel Crosley, Jr., as chairman and L. A. Nixon executive secretary. There were other cooperating committees from the National Association of Broadcasters and the Radio Manufacturers' Association. The editors of RADIO BROADCAST felt in planning the test this year, that the interest caused by the first two Tests, which were almost entirely managed from this office, had made the affair so important that the entire radio industry should be represented in its management.

The Test Committee at its headquarters in New York managed the American side of the affair and furnished the newspapers and press associations with daily and hourly bulletins. Certain newspapers in representative cities were furnished with the official programs as received from the foreign representatives of RADIO BROADCAST. This made the task of checking foreign reception vastly easier and far more accurate than in the previous two Tests. Busy long distance wires, and piles of telegrams at the New York office made the scene there dur-

ing the Test Week one of the most active we have ever witnessed, and we have been in more than one metropolitan newspaper office at World Series time, or on the occasion of a big disaster.

A large number of official listening posts were appointed by RADIO BROADCAST and their reports, sent in by mail, telegraph, and by the short wave amateur radio link with our experimental station 2 GY was of constant help in determining how receiving conditions were in all parts of the country. Many radio manufacturers had special receiving stations. The National Association of Broadcasters appointed a listening committee, headed by Paul F. Godley, of Upper Montclair, New Jersey. Mr. Godley, it will be recalled, about five years ago was successful in hearing American amateur transmissions, the first across the Atlantic, from a special receiver he established at Androssan, Scotland. The Boston *Herald-Traveler* established a listening station at Baker's Island near Boston, manned by several operators, and a meteorologist. F. R. Hoyt, of Stamford, Connecticut set up his interesting radio recording apparatus at Shippan Point, Connecticut, and reported that he succeeded in making partial records of foreign programs. R. P. Worden, radio editor of the *Cleveland News* sent especially complete reports of receiving conditions and success in the Cleveland area which were very helpful.

In addition, RADIO BROADCAST had several receivers in operation at Garden City, and two operators were constantly on watch at station 2 GY using the 40- and 80-meter transmitting bands simultaneously. During the Test periods, 2 GY received frequent reports from all parts of the United States on receiving conditions, and on several occasions, communicated directly with Europe to discover weather and receiving conditions at the time. An article on another page of this number describes in part some of those arrangements with short wave communication. Receiving conditions are never especially favorable at Garden City for extreme long dis-

tance work, so several members of the staff took sensitive receivers to Riverhead, Long Island, where it was thought that the air would be free from radiating receivers and their havoc. Even there, miles from the nearest house, the bloopers got in their furious work.

#### THE BUSINESS OF VERIFICATION

**R**EPORTS from listeners in this country went chiefly to the local newspapers, to the broadcasting stations, and to radio manufacturers. Many newspapers furnished verification cards to successful listeners. Telegrams sent to RADIO BROADCAST for verification of reports were answered the same day they were received, which was no small chore, considering their number. Letters with details of reception have come in to our office by thousands and are being checked and verified as rapidly as possible. An official verification card is being mailed to all listeners who write to RADIO BROADCAST whose report can be verified.

This task of verification is not easy, but its onus is frequently broken by conscious or unconscious humor. "While listening last night," reads a sample letter, "I picked up a lady singing on 360 meters, but she soon faded out. Can you tell me who it was?" This achievement, if it is a radio affair at all, is worthy of note, and a curiously large number of letters read just like that. Verification from such meagre information is out of the question and there are probably many disappointed listeners whose letters were equally bare of facts who still wonder why "the coveted pasteboard" was not sent them. Still others sent in confident letters announcing that they heard 2 LO, or Madrid, or whatnot, "very clearly," but failed utterly to specify their success in detail. Reports like that were not considered. But many others mailed reports that were more than complete and very accurate, making our task almost easy.

The question that everyone wants to have answered is: What success did listeners have generally, and what foreign stations were heard? There is not space enough at our disposal to list the listeners whose reports have been verified, but it is possible to tell what stations were most generally heard. Station OAX at Lima, Peru, was heard by more listeners than any other, and that is no mean accomplishment, from the point of view of distance and can be pointed to with as much pride as the electrical bagging of a European broadcaster. Reports on English stations were few and far between, but all of the English stations participating were heard in various parts of the United States. Almost no Canadian listeners heard British broadcasters. The Madrid and Barcelona stations got through to the United States very well also. Prague, Munich, Berlin, Hamburg, Brussels, and Munster were also widely reported during their transmission times. Hamburg signed off in code with the letters "h a" and one faithful reporter although he did not know the Continental code, related that he heard the name of the city and the code sign, four dots, dot dash.

#### NO RECEIVING LOCATION PERFECT

**T**HERE were spots of fair reception, although in no locality did any of the transmitting stations come in with any laudable volume. In parts of New England there were a number of successful listeners who heard both Europe and South America. There were a few, similarly fortunate, in eastern Pennsylvania, New Jersey, and New York. A listener in Bermuda heard Madrid and he reported that many other Bermudians heard LOX, and numbers of European stations. Moving farther west, there were a considerable number of listeners in southern



NEWS HEADQUARTERS FOR THE TESTS IN NEW YORK CITY

With L. A. Nixon, Secretary of the International Radio Week Committee, wearing the telephone receiver. During the Test Week, an office was set up in the Hotel McAlpin, New York, where official programs were given to the Official Radio Week newspapers; the United Press, and the Associated Press were given hourly bulletins as to the progress of events. This left the wires freer at Garden City for communications from our official listening stations

Ohio and Kentucky who heard fragments from the Continent and more than that from the South American stations. Missouri seemed to be fortunate in having more favorable receiving conditions than some of her neighbor states. Reports from the Middle and Far West were scattering, but in these localities, OAX at Lima, and the Buenos Aires stations seemed to get through quite consistently.

The unfortunate atmospheric conditions affected reception on the other side of the ocean and only four American stations were reported heard by our foreign aides. Mr. Tripp, in Paris, reported that KDKA was heard there and Mr. Harris, in London radioed that WGY, WJAZ, and WLW had been heard in England. Other reports may yet come through by mail. It was reported by the Associated Press that WFAF and WJZ had been heard in Moscow and in Germany, but no further verification could be obtained.

Mr. Paul Godley, whose reputation as a radio authority is of long standing, reported some very interesting conclusions from his listening post at Barnegat, New Jersey. He had a special antenna and about eight sensitive receiving sets under his direction. On every evening of the Tests, it was his experience that receiving was much better in a north and south direction than east and west. This condition, he avers, has always held good in the United States, but was particularly noticeable during the Test week. As an example, on one evening, he was able to hold the entire program of OAX at Lima, with fair volume, while not even a carrier wave could be heard on any of the European frequencies. Other careful observers noted the same condition and it is unfortunate that there is not room to quote from their reports.

It is interesting to note that practically all of those who listened during this Test and during the two which preceded it, accepted the challenge of the thing in the sporting spirit in which it was conceived. All realized that there was no absolute certainty of hearing any of the foreign stations, but made their best receiving efforts and took their chances of success. Even a casual glance over the mass of mail which has been sent to Garden City about the Tests from radio enthusiasts in every section of the country, shows that no listener is childish enough to think that because his receiver failed to bring in a foreign program on the loud speaker that therefore radio is all wrong, overestimated, and a failure.

PRINTABLE REMARKS ABOUT BLOOPERS

THERE is something to be said about radiating receivers, although indications are that a wide variety of remarks, mostly unprintable, have already been made about the subject during the Tests. "International radio week," says the Hamilton, Ontario, *Spectator* editorially, "is proving to be just a howl, instead of the howling success it was hoped it would be." And with this terse opinion about oscillating receivers everyone seems to agree. Says the Kansas City *Star*:

Whatever conclusion may be drawn by the committee in charge of the International Tests as to the success of transoceanic broadcasting, it can be definitely stated that the Tests demonstrated to radio listeners the menace of the radiating receiver and the ignorance of many persons in the operation of such sets.

The silent hour for the hundred of licensed broadcasting stations was only the signal for thousands of unlicensed bloopers to fill the air with such howling, squealing, and sputtering as to make it a miracle indeed that any listeners were able to pick up foreign broadcasting. . . . Such a situation is a hangover from the early

days of radio when no thought was given to the matter of radiation; when single circuits and regeneration were the vogue with builders whose chief object was distance. In the last two years, these circuits have been gradually junked in favor of the more advanced sets. . . . Reports of foreign reception have been frequent, yet not at all in proportion to the number of receivers capable of the distance jump to Europe. Those that were not prevented by interference, probably gave up where the repulsion against squeals was stronger than the lure of DX.

The *Star's* radio writer has well put the case for the whole country. There is not a community in the United States where the blooping receiver did not make distance reception nearly impossible. Those who were successful in getting through were either fortunate in their neighbors, or fortunate in an especially good location, or both. One imaginative listener, in describing his experience to us said, "It was like trying to pick out the buzz of one bee through the sound made by an entire hive, when I tried for Europe through the barrage of squeals."

Our correspondents have been eloquent on the subject of the radiating receiver and it is hard to refrain from quoting indefinitely. Mr. Charles Temple of Waltham, Massachusetts, wrote:

For three nights now, my wife and I have sat for one hour with the head phones on, taking the punishment that is meted out to us by the thousands on thousands of bloopers. It is



January 24, 1926

January 30, 1926

INTERNATIONAL RADIO BROADCAST TEST

Under the Auspices of RADIO BROADCAST Magazine

This Certifies That

Mr. Charles Ellis,

Located at Clark Island, Maine

Has assisted and participated in the International Radio Test, and that information received and checked at Radio Broadcast Laboratory (Headquarters of the Test) indicates successful reception of test programs from cooperating European Stations.

6 Bm.  
Garden City, New York  
Brunswick

284  
Arthur H. Lynch  
Chairman International Tests  
Editor Radio Broadcast

THE VERIFICATION CERTIFICATE

The successful listeners who heard European or South American stations received an official verification card from RADIO BROADCAST similar to this one issued to Mr. Charles Ellis of Clark Island, Maine

absolutely past description the noise that we get from these radiating sets, and I want to say in capital letters that man has never made a set that will distinguish even a local station, to say nothing of foreign ones, through the din that they set up.

It is our suggestion and the suggestion of all other radio lovers who get pleasure from the air and who are interested in the future of radio that you spend the next season in efforts for legislation against these bloopers who are a hindrance to the whole future of radio. I am not a chronic kicker, either, but I'm only one of thousands who have been standing by and watching this nuisance increase rather than diminish for the past two years. I am not in the radio business, but am simply an ordinary citizen who likes to stay at home nights and get some pleasure out of the air without listening to the sound of fire sirens ripping up the atmosphere.

Mr. Temple adds another word, which, al-



THE STUDIO OF STATION SBR AT BRUSSELS

SBR was one of the European stations very generally heard in this country and succeeded also in pushing its signals to the United States during the Tests in 1924



© Barratt's

WHEN 5XX WAS UNDER CONSTRUCTION

The Daventry station of the British Broadcasting Company, using 25 kilowatts input now furnishes good program service to a very large number of British and Continental listeners. But during the Tests, the signals of 5XX were not reliably reported in this country, despite the fact that a 1601-meter wavelength was used, a frequency which WGY has reported to be most satisfactory for general relay work

though perhaps not applying directly to the subject in hand, is a graceful bit of praise:

I want to thank you (RADIO BROADCAST and the International Test Committee) and let you know that I certainly appreciate the time, money, and effort that you have spent in the months past in an endeavor to give American radio listeners an interesting week, and perhaps the thrill that comes once a year in hearing music from across the Atlantic.

RADIO BROADCAST has been working for the better part of its magazine career against the

(London) of the 1924 Tests:

The second International Radio Week was held in November, 1924, and although agreements had been made with all the American broadcasting stations to "keep off the air" during the periods of the European transmissions so as not to interfere with these transmissions, the results were not, on the whole, very satisfactory, as atmospheric conditions during the week of the tests were remarkably unfavorable. It was just a matter of bad luck that this was so, because reception during the week before and during the week after was very good.

radiating receiver, has never described a receiver that will radiate, and frequently, at a severe financial disadvantage, has refused to publish advertisements featuring radiating sets. But the fight is apparently a losing one, and our own weapons not strong enough to combat a menace of this size.

RECEIVING CONDITIONS

THE weather conditions were even less favorable than they were during the Tests of 1924. Here is what Captain A. G. D. West, assistant chief engineer of the British Broadcasting Company, wrote in an article in the *Radio Times*

Very few of the reports of reception could be verified.

Reports from all over this continent showed that reception was bad, not only on the foreign programs, but also on American stations. "KFI and KGO are, under average radio weather conditions, easily picked up in this locality," writes W. W. Mulr, of Lockport, New York, "and under extremely favorable conditions, are heard with great volume and clarity. For the last four or five nights, it has been impossible to pick up even the carrier wave from either of these stations with a very sensitive receiving set." And Wilfred Taylor, at Thompson, Connecticut says: "Atmospheric conditions, with the possible exception of those in evidence on Wednesday (January 27), were unspeakably bad. Western United States stations were entirely blank, and none but the large Eastern stations could be heard. On Wednesday, I got through to KGO with fair speaker volume, and on that night code and bloopers were heard all over the lot."

And from far off North Dakota, Professor E. W. Bollinger, of the University of North Dakota, at Grand Forks writes:

The failure to receive foreign stations was undoubtedly due to the extremely poor weather conditions, it being impossible to receive United States stations with sufficient volume, and in some instances, it has been impossible to receive a single station. This condition has prevailed during the larger part of the winter and is perhaps the poorest reception we have ever experienced.

Receiving conditions can not be guaranteed in advance, and in choosing January, we thought that a great improvement would be noticed. Receiving conditions in the first year of the Tests were rather good, and as Captain West of the British Broadcasting Company writes:

The first Test Week gave rise to a great interest in transatlantic broadcasting, in fact, this can be referred to as the beginning of interest by the general public in receiving and transmitting broadcast programs across the Atlantic. Conditions during this week were, on the whole, fairly good and a very large number of amateurs in Great Britain were able for the first time to hear on their own sets some of the broadcasting stations of the United States. Also, the reports of reception of British stations by amateurs in America were very many, of which some thousands were verified.

THE POPULAR REGIONAL TESTS

ASIDE from the correspondence and invective by the bloopers' performance during the Tests, the innovations of the North and South and East and West test of the last two nights of the Tests appeared to create the most interest during the period. It suggested to many listeners that here was a national arrangement which might be well continued in the future. Listeners on the Pacific coast rarely hear Eastern United States stations, owing to the difference in time. And stations in Mexico and South America are infrequently heard because stations here operate simultaneously on similar frequencies. During the silent period for American stations, the sonorous call of CZE of Mexico City was heard all over the United States, and the announcer at that station made many friends by his thoughtfulness in frequent announcements.

"I think it would meet with the approbation of thousands of radio fans," writes Henry B. Newhall of New York, "if perhaps not this winter, but possibly during next season, regional broadcasting, preferably during two hour periods similar to those of the last two nights of the Tests, could be arranged to take place every



THE "RADIO BROADCAST" EXPEDITION ON LONG ISLAND

Setting up the short wave transmitter and receiver near Riverhead, Long Island. The short wave link connected the listeners with headquarters at Garden City. What with blooming receivers and unfavorable receiving conditions nothing more definite than strong carrier waves could be heard at that location. In the photograph, left to right: Arthur H. Lynch, editor of this magazine; Keith Henney, director of the Laboratory; John B. Brennan, technical editor



MANY LISTENERS MADE SPECIAL PREPARATIONS FOR THE TESTS

The photograph shows a special antenna being put up at a good receiving location on Long Island. Practically every listener overhauled his set, steamed up his batteries, and tightened connections, all to hear the foreign signals. The overhauling is not such a bad idea regardless of the Tests. It is a good plan to go over a set at least every six months



A SPECIAL LISTENING STATION IN MASSACHUSETTS

Samuel Curtis, Jr., and Leslie Barnard of the *Boston American* at their receiving station at Pembroke, Massachusetts. In all parts of the country, deeply interested listeners took an assortment of receivers to the best location near by they knew of and did their best to pull in the foreign signals. Mr. J. L. Snyder, of Patton, Pennsylvania, for example, set up a receiver on the side of a mountain and reported very successful reception

two weeks or every four weeks. I should think it would not seriously interfere with the programs of the regular broadcasters if the tests were arranged for the mid-week so that they would not break in on Saturday and Sunday programs. Such an arrangement is really about the only chance now we have to give our sets tests for distance. The only other way I can get California, for instance, is to rise up out of my warm bed at two o'clock in the morning. My bed has usually looked better than California."

question of silent nights. It might be wise, for instance, instead of silencing all the stations in one city, so that listeners could hear programs from other cities, to arrange for silent periods for all stations in one time belt to be silent, either for several hours, or for an evening. We suggest this, knowing full well that it will start a storm of protest in some quarters. Our own feeling in the matter is quite neutral; after all

the matter is for the majority of listeners to decide. We believe pretty firmly in the sovereignty of the local station. It should be able pretty generally to meet the wishes of the majority of its listeners in most instances. If it fail, then the listeners ought to become vocal and state their feelings.

And so we write "Finis" on the 1926 Tests Better luck next time!

There is a great deal of interest in the question of regional broadcasting, with silent periods for the other groups, and it may be that this may point to a solution of that always debated

A CORNER OF THE EXPERIMENTAL LABORATORY AT WGY

With a monitoring operator at the desk. This is a part of the short wave, high power transmitter installation. During the Tests, WGY used its usual power, although on the intersectional transmitting periods the last two days of the Tests, 50 kw. was employed. The station was heard in England and on the Continent

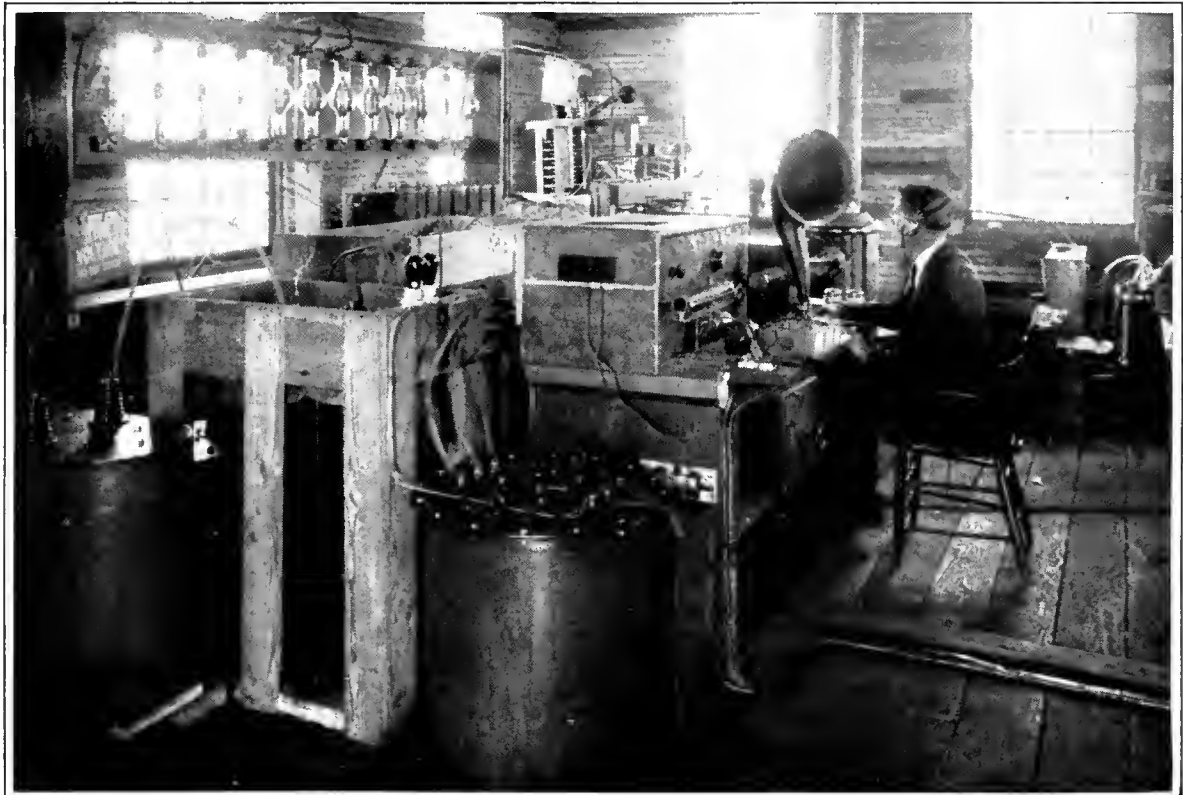

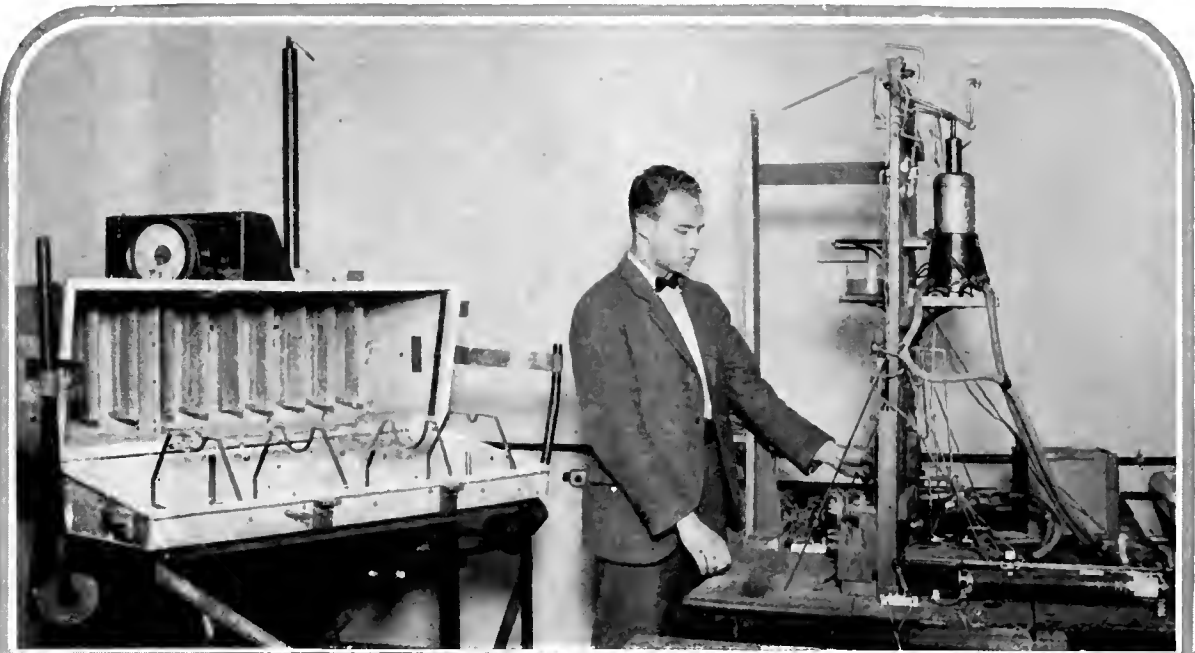

# THE MARCH OF RADIO

By *J. J. Morecroft*

Past President, Institute of Radio Engineers

## A Legal Test Case For Our Radio Laws

**T**HE government, it appears, is engaged in testing the legality of the present regulations of radio broadcasting stations and the outcome of this test case will be followed with profound interest by all of those operating broadcasting stations and by many of us who merely listen.

Station WJAZ in Chicago has questioned the authority of the Department of Commerce to regulate its broadcasting assignments. This station is owned by the Zenith Radio Corporation and the issue is created by Mr. E. F. McDonald, Jr., who has much to say about "the freedom of the air." Well, we hasten to comment that there is no such thing as freedom of the air in the sense that Mr. McDonald uses it. The tactics he has pursued in forcing legal action on the part of the Department of Commerce are unfortunate.

Some time ago, apparently at Mr. McDonald's request, his station was assigned to operate on the same frequency with KOA, the General Electric station at Denver. Only two hours a week were free, so WJAZ was given these two, a small share of the time, we do admit. Not being content with this allotment, the Chicago sta-

tion searched for another channel and found a neighboring one frequently free.

This new frequency selected by this active philosophy of force had been reserved, by mutual agreement, for the Canadian stations. Of the ninety-five available frequencies in the present broadcast band, we have appropriated eighty-nine and left only six for Canada. Now a "freedom of the air" exponent finds it necessary to step into one of these six Canadian channels. This presents not only a national, but an international radio problem of serious proportions.

Mr. McDonald has given a statement of his case to the press and we can easily see his reasons for feeling aggrieved. He has invested a deal of money in his station and now finds it practically valueless. He feels that he has been discriminated against—that he has as much right on the air as any other broadcaster. After having spent several weeks in Washington trying to get an assignment from the Department of Commerce and not having achieved the success he expected, he evidently felt that he was entitled to go back home and try other means. Perhaps the course was justified, but why bring Canada into the fray? Certainly her meagre share of the ether could be left alone.

Why didn't Mr. McDonald start to

operate on KOA's time? He felt, according to his statement, that stations such as KOA had been assigned a disproportionately large part of the total time—166 hours a week to two for WJAZ. Of course the General Electric Company could reply that they had been using the channel regularly and possession being nine-tenths of the law, they are entitled to keep the channel.

The question of division of time between the stations operated by the Radio Corporation group and "independent" stations is suggested in Mr. McDonald's press statement and we think it brings up a very important point. Someone should compare the R. C. A. group "channel-hours" to the independent "channel-hours" and let us see where we stand on this question. We have twice legislated that the ether is inalienably the property of the citizens of the United States so we had better take inventory and see whether it is or not.

Even if the combine controls 75 per cent. of our broadcasting time we are not at once ready to denounce it. Are the people more pleased to listen to the combine stations or the independent stations?—that is the thing that really counts. The people of the country are the ones who have "the freedom of the air" and not the owner of any special broadcasting station.

The photograph which forms the heading for this month shows H. I. Rothrock, Jr., of the radio laboratory, Bureau of Standards, Washington, testing the high vacuum pump used for exhausting tubes. (© Harris & Ewing).

## The Institute of Radio Engineers Convention

THE first national convention of the Institute of Radio Engineers recently closed and even the most modest commentator must declare it was an unexpected success. Not only did the attendance justify the opinion that there is a host of capable engineers working in the radio field to-day, but the fact that so many of them should come long distances at considerable expense speaks well for the past year's prosperity in the radio business. Enthusiastic as radio workers may be, without a materially prosperous business behind them backing up their plans and ambitions, the engineers could not have turned out in the numbers they did.

The Institute is not yet fifteen years old but the membership already totals about three thousand. Probably in no other national engineering society is there such a preponderance of young men, and it is the presence of young men in an association of this kind that promises much for its future. The older societies with their venerable and bemedalled members of the engineering profession may well point with pride to the accomplishments of these well-known figures, but their work is in general in the past. It is in the hands of the younger and almost unrecognized members that the future of the profession lies.

It was with some doubt that the Board of Direction of the Institute started their plans for this first convention but the out-come well justifies their judgment that it would be worth while. Such a call a decade ago would not have gathered more than a dozen men, but so great has been the recent demand and the resulting supply for technical radio men that several hundred attended this meeting. The convention did not attempt the ambitious programs carried through by some of the other engineering bodies, yet there were some valuable papers presented and interesting and profitable trips were planned to the Bell Telephone Laboratories, to the high-powered station wjz at Bound Brook and to the factory of the A. H. Grebe Company operating station WAHG. The session closed with a most successful banquet and we must admit that never before had we believed that so many radio workers could attend a five-dollar dinner, but there were hundreds of them there to testify to radio's prosperity. Jewett, Nally, Alexanderson, Langmuir, Fessenden, and other noted workers in the radio field gave brief talks, all of them bringing out the tremendous strides radio is sure to make in the coming decade. (The modest writer of these editorials was also among the speakers.—Editor.)

RADIO BROADCAST announces with regret that Mr. Arthur H. Lynch, who has edited the magazine from its third number to the present one has decided to leave editorial work and go into manufacturing.

The managing editor, Mr. Willis K. Wing, will succeed him, and the rest of the staff will remain the same, with Mr. John B. Brennan as technical editor, and Mr. Keith Henney as director of the Laboratory. The policy of the magazine will continue along the lines set during Mr. Lynch's editorship. Professor Morecroft will continue to write "The March of Radio" and the other departments will be continued by the same writers.

DOUBLEDAY, PAGE & COMPANY.

## What the Australians Think of Their Broadcasting

NO POSITIVE methods of comparing foreign broadcasting with that in the United States exist, but it is always to note what outsiders say. A. W. Watt, editor of *Wireless Weekly* (New South Wales), writes:

The broadcasting in Australia is excellent. This is the well-considered opinion of an official of one of the largest British wireless concerns. This opinion coming from one who has, if only from a business point of view, intensively studied the quality of British broadcasting which is conceded even by our cousins in America to

be the finest in the world is worth having.

When did we concede audibly that British broadcasting was better than ours?

And further—a Sidney trader, after a trip to the United States, said:

I went over there to admire American broadcasting but I came back with the full conviction that taken all around our Australian broadcasting was better. More boost has been put into American broadcasting than into any other thing and it becomes natural for us to associate everything that is good in broadcasting with the country whence that boost emanates. . . . We blink at the fact that America . . . is now up against a serious problem of extricating the broadcasting situation from the chaotic condition under which it labors. . . .

And then to make sure that we are down for the count of ten—"if we must pattern ourselves after somebody else let it be after the British system which, built up on a solid foundation, stands out as preëminent." This is criticism indeed, from one of our most respected neighbors. Are we really as good as we have been telling ourselves we are?

## "An Official Indiscretion"

UNDER this caption, the editorial writer of the *Wireless World* takes to task that admirable British engineer, Captain Eckersley, Assistant Con-



SOME OF THE LEADING MEMBERS OF THE INSTITUTE OF RADIO ENGINEERS

Photographed during the recent convention of that organization in New York. In the front row, reading left to right: Frank Conrad, assistant chief engineer of the Westinghouse Company, who received the 1925 \$500 award of the Institute for his work in short wave broadcasting; Donald McNichol, president of the Institute; Dr. J. H. Dellinger, director of the radio laboratory, Bureau of Standards, and retiring president; Dr. A. N. Goldsmith, chief broadcast engineer, Radio Corporation of America; R. H. Marriott, first president of the Institute; second row, left to right: W. H. Hubley; John V. L. Hogan; C. W. Horne, manager of radio for the Westinghouse Company; Lloyd Espenschied; A. H. Grebe; Professor J. H. Morecroft of Columbia University and member of the staff of RADIO BROADCAST; Melville Eastham, president of the General Radio Company; Dr. G. W. Pickard, research engineer, Wireless Specialty Apparatus Company; L. E. Whittemore, and Dr. E. F. W. Alexanderson of the General Electric Company

troller and Chief Engineer of the British Broadcasting Company.

In an interview entitled "A Talk to Homemakers" he saw fit rather severely to criticize the enthusiast who buys parts and assembles them into the well-known home-made set. Not only did he tell the radio "tinker" that he was generally wasting his time and money but further intimated that the home builder was actually doing an unethical thing; that he was using ideas which had cost the manufacturer thousands of pounds to develop and for which the manufacturer was entitled to believe that the radio listener would buy his sets and thus help pay for the cost of research. "If home making simply means copying what some one else has taken pains to design, may I suggest that mental indigestion may result, and more, might I point out that a new and great industry is being hampered?"

The home builder is one of the important

vitamines of the radio industry. He really learns a lot about radio, he spends much money for parts; he spends his time at home, contented and enthusiastic about his task, he occasionally lets his family actually listen to a whole selection from some distant station before he tunes to another, and in many instances he also buys a manufactured set. So actually instead of cheating the set manufacturer from his legitimate profit he generally does contribute his bit and in addition creates a healthy demand for "parts."

### The Recent International Radio Broadcast Tests

**T**HIS year's international tests ran into difficulties with a vengeance.

It seems as though nature, as well as the bloopers, were making all efforts to keep America for Americans. It probably pleased many of our short-sighted senators

to think that circumstances were doing so well to keep us from being contaminated by touch, even over an ether channel, with our transatlantic fellow men. Rapidly changing weather conditions, which always bring plenty of static, resulted in violent Atlantic storms, and as soon as the static had partially abated, the transoceanic channels were required for more important service than that of friendly intercourse. Radio was being used to locate the men who were fighting against death in the ocean storms, and no one of us has ever begrudged giving up his radio hours for such a cause.

The law of compensation played its part in the ocean tragedy, however; one of the benefits of these International Tests which some of us had continually urged is that arising from the better understanding between nations. This must result from our repeated attempts, always more successful, to get in radio touch with those in Europe and South America. When peoples are in

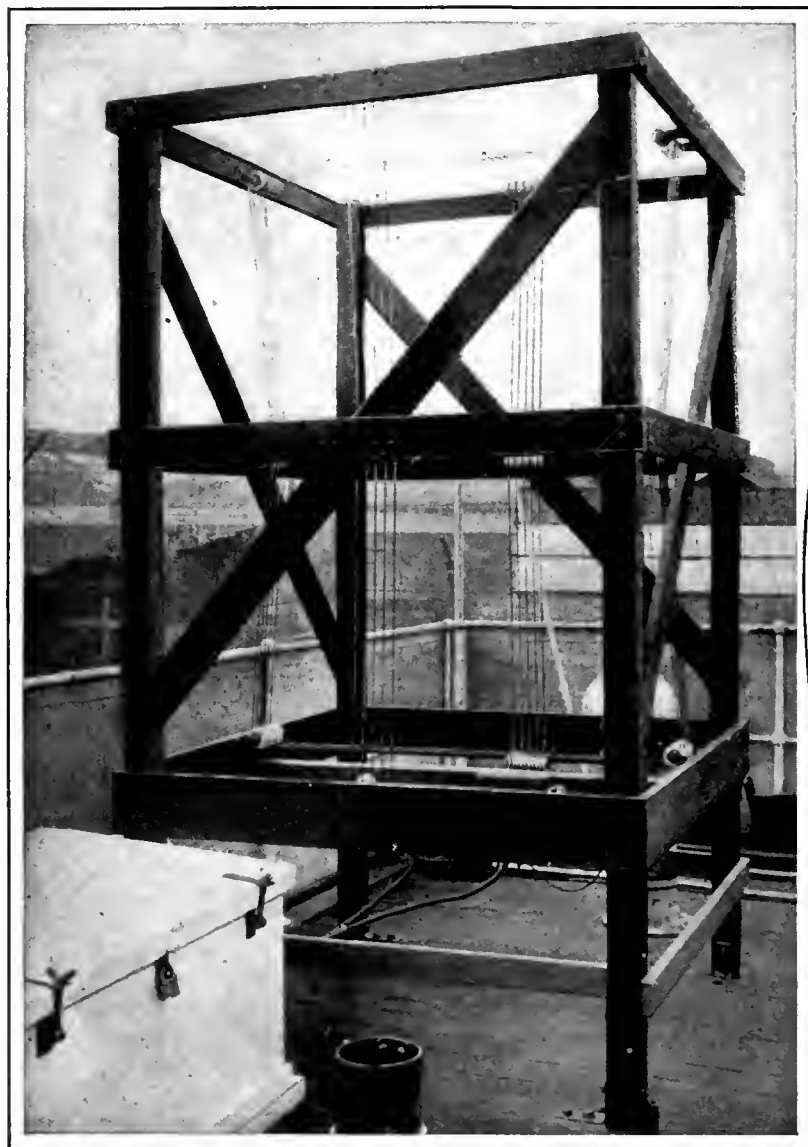

### MARINE RADIO DIRECTION FINDERS

Three nations have recently joined to honor the Captain and crew of the S. S. *President Roosevelt* on their rescue of the crew of the British steamer *Antioe*. It was radio which brought the rescue ship and the radio compass which guided the *Roosevelt* to the drifting *Antioe* after the American ship had drifted more than 100 miles out of her course during the night. The large illustration on the right is the Kolster radio compass installed on the bridge of the S. S. *President Harding*, a sister ship of the *Roosevelt*. The wheel operates a loop above, which leads to the receiver at the right of the operator. The view at the left is the antenna of the British Bellini-Tosi direction finder, installed on the bridge of an English merchant ship. Its principle of operation is somewhat different from the Kolster system used on American vessels



close communication with each other, many sources of friction and causes of discord will disappear. Now the time used for the sos calls during the International Test schedule resulted in American crews and German crews risking their lives for British crews, certainly an international episode of as much importance as the exchange of the "Star-Spangled Banner" for the strains of "God Save the King."

This year's Tests further emphasized the undesirable character of the regenerative receiver in the hands of unskilled or careless users. Much of the time when the air was otherwise clear and the chances of having European and South American radio channels end in our homes, was rendered useless to us by the howling receivers. As soon as we located one of the transatlantic channels and were endeavoring to copy the program, a flock of howling receivers would start to work around, trying to locate the same station. It is high time that common decency to our neighbors prohibit the use of such equipment and especially on such an occasion as the long-distance tests.

How They Run Radio in Canada

**I**N CANADA the radio activities of the government are carried out in the Department of Marine and Fisheries, a logical place for it when we remember that radio served the marine service long before it was used for broadcasting entertainment. We have commented before on what seemed to us the very reasonable and sane course the Canadian officials take in developing radio—in fact, we have also previously expressed the opinion that the work was done in a manner somewhat superior to that which our officials display in attacking radio questions. It is good to find the quality of directness of attack for which the Canadians won a reputation during the war, shown in the annual report of the Canadian radio service.

The total number of stations coming under government supervision is 93,049, apparently a prodigious number, but we hasten to recall that all receiving sets are classed there as receiving stations and come under government supervision. There are 92,000 of these receiving stations in the dominion which pay to the government \$1.00 a year for their operation. After reviewing the compass service and the twice daily weather report to shipping, the probable development of radiophone service to certain classes of shipping is discussed. The ordinary weather and compass reports are of course sent out in code and the receiving ship must have a trained operator on board. But it is thought that harbor shipping might use radiophone channels and thus get the benefit of radio without the expense of a specially trained man. A frequency of 1500 kc. is to be used so as not to interfere with broadcast channels. It seems to us that such a scheme is only practical when the shipping is not dense. Around New York harbor, such an attempt would be unwise indeed.

Strange as it may seem to those in control of our governmental attitude, the Canadian government has a definite policy by which broadcasting licenses are issued. "One wavelength is issued to each city or area and three stations are licensed to use it, one station at a time. In case the licenses are unable to arrive amicably at a division of time, the department itself divides the time on an equitable basis." This is different from the Cincinnati row we had when the Department of Commerce officials said it was none of their business and left the stations to fight it out. In the larger Canadian cities, a second wavelength is assigned but the station operating on the second wave must be at least ten miles out from the city!

For the past two years, licenses issued by the Department have permitted indirect advertising without restriction and direct advertising before 6 P. M. In spite of the permission, practically all direct advertising has been abandoned, the stations apparently having reached the same conclusion that direct advertising fell on "deaf" receiving sets.

In 1923 the United States assigned to its numerous licensees all of the broadcast bands available for this continent, a not very neighborly action. Ninety-five channels to be properly proportioned between Canada and ourselves so we use all of them! "As a result, the transmission of practically every one of our stations was subject to severe interference." The United States Department of Commerce finally agreed to regard six of the ninety-five channels as exclusively Canadian and also to use certain of the other channels for our southern stations only, that is, these channels might also be used by our northern neighbor. Taking into account the unlikelihood of

West Coast stations interfering with her eastern stations, Canada counts on 19 available channels.

Continues the report:

Every Canadian station is checked each night by some specified inspector and offending stations are at once ordered back to their specified wavelength. Should the offending station be under the jurisdiction of the United States, the Supervisor of Radio for the area in which the offending station is located is advised by telegraph and in all cases promptly and effectively attends to the complaint.

The report speaks of the surrender of the 1000- and 660-kc. channels by the shipping approaching our shores. They are not used by ships of Great Britain, United States, Belgium, Denmark, and Sweden when within 250 miles of our shore. "Unfortunately France has not seen her way to accede to our request and we still have a prolific source of interference in the coast station operated by that government at St. Pierre Island, south of Newfoundland." Under the caption "Regenerative Whistles" we learn that "We have as a matter of fact, considered getting all the Canadian radio manufacturers together with a view to having them mutually agree to stop the manufacture of the regenerative type of apparatus. But as there is no legislation available to compel any manufacturer to abide by the same, etc.—"

With comparatively few broadcasting stations (only nineteen channels), Canada has thirty-eight inspectors. "Generally speaking," the Commissioner modestly concludes, "the Canadian broadcast listener would appear to receive at least as much, if not more, service than the listeners in any other part of the world, whether licensed or not, and we have not as yet really got into our stride!"



RADIO HEADQUARTERS OF THE SIGNAL CORPS

At Washington, all the official business of the Signal Corps of the Army which is transacted by radio through the network of Army stations is received at this central office. General Saltzman, Chief Signal Officer, reported recently that radio was the means of saving a large sum over the usual telegraph tolls paid by the Army for official communication. This radio central is located twenty feet below large receiving loops on the roof of the building



REGINALD A. FESSENDEN

Chestnut Hill, Massachusetts—  
at the Institute of Radio Engineers  
Dinner, New York

*"There are in existence to-day, fully developed and tested, wireless methods for operating substantially without disturbance from static or interference, and these means have been tested with large capacity high antennas between Boston and Panama, in summer.*

*"There are also in existence to-day, fully developed and tested in all essential details, wireless methods for operating direct, without exchanges, by setting direct to the subscribers' numbers, between bodies of subscribers as large as those comprising the New York exchanges.*

*"The wireless ptherscope has been developed from the first crude apparatus of 1906 to a device capable of putting wireless vision into every house in the United States, and was tendered to the United States Navy under guarantee in 1921, and to others. Its success depends upon two inventions—the multiple valued function method, as it is called, and the shutter which has been operated by independent engineers at a frequency of 400,000 per second and is capable of more. I have pleasure in showing you the shutter, a photograph showing its general arrangement in action, and a sample of the wire used, of which it takes 900 twisted together to make the size of a single hair; and of presenting these historical exhibits to the archives of the Radio Engineers."*

### The Month In Radio

THE large station at Rocky Point (Radio Central) has for some time been able to send telephone messages across the Atlantic to England where a receiving station has been set up at Chedzoy; this, it is expected, will be the English receiving station for the transatlantic radio-telephone channel. The British have been at work on a transmitting station for their end of the channel and a cable to the *New York Times* says that the station is now complete and has been taken over by the British Postoffice, which will operate the communication scheme.

The English news puts the price of a three-minute talk to America at five dollars. This seems like an unreasonably low price for the

service and certainly cannot be based on the idea of earning a reasonable return on the investment.

NOTHING more indicative of the emancipation which Turkish women have experienced in the last decade has occurred than the broadcasting of a speech by the wife of the Curator of the Evkaf Museum in Constantinople. Only a few years ago the face of the Turkish women could be seen by her master only, and never could she talk to other men. Now she not only shows her face as other women do but addresses an audience numbered in the hundreds of thousands by the most modern of our scientific achievements. Mme. Aly addressed the British radio audience on "The Turkish lady of Yesterday and To-day." The topic certainly seems to offer opportunities for some striking contrasts.

FROM WGY, the radio audience had a chance to listen recently to a most striking experiment. Professor Wold of Union College, gave a series of talks on the electron and its activities and during one of his lectures he let his listeners actually hear an electron as it splashed its way through a cloud of gas particles. Some substances, said to be radio-active, are continually shooting off positive and negative electrons, and as these, traveling at high speed, bump their way through a small air chamber and so affect the air particles they bump that the air becomes partially conducting. This change in the conductivity of the air is made to affect a vacuum tube amplifier and thus modulate the carrier wave of the broadcast station. The noise is scarcely more pleasing than static noise, but it will be certainly more interesting when one realizes that each noise represents the collisions caused by one electron, the smallest thing in the universe of which the scientist knows to-day.

### Interesting Things Said Interestingly

GENERAL J. G. HARBORD (New York; president Radio Corporation of America): "The world leadership of the United States in the development of the radio art and industry has won for our manufacturers and engineers a dominant position in the radio affairs of South America, where to-day the greater percentage of the total business is carried on by Americans. In spite of foreign competition, our products and methods remain the most acceptable to South Americans. Our four years of experience in the development and production of broadcasting devices both for transmission and reception, has stood us in good stead in Latin America. Americans are contributing a full measure of this experience toward the development of radio in South America and we have the hearty cooperation of local South American radio interests."

E. F. W. ALEXANDERSON (Schenectady; Chief Consulting Engineer, Radio Corporation of America): "The great problems in radio are static, interference and fading. The trend of the radio art in the past has been determined by improvements that have been made in overcoming these difficulties. The practical solutions of these problems to-day are; directive reception for reduction of static; continuous waves



CAPT. A. G. D. WEST

London; Assistant Chief Engineer—  
British Broadcasting Company; in an  
interview before the recent  
International Tests

*"The tests will not give such a unique opportunity to European listeners because they can listen on any night to American stations without fear of interruption from broadcasting stations on this side of the Atlantic. American stations usually take very great care with regard to maintaining their wavelengths and their power constant over long periods of time, so that amateurs on this side who want to do serious experimental work on long distance reception on various wavelengths, can do so throughout the winter season, but there are not many experimenters who would have time and opportunity and also inclination to listen in the early hours night after night for American stations to obtain data that will be valuable from a scientific point of view, and it is during Radio Week that a more useful opportunity is given to those who want to try occasional American reception.*

*"Even now it is not advisable for listeners with sets containing less than two valves to attempt to pick up these (American) programs, and it is certainly most important to make sure that the sets do not oscillate and cause local interference. Even just a few oscillators playing around the wavelength of a distant station can completely spoil the reception of that station by listeners situated many miles around."*

to minimize interference; and the use of long waves to minimize fading. The future answer to these problems may be different. At least we have reason to think that the new knowledge which we have gained regarding wave propagation will furnish us additional methods of discriminating between signals and disturbances. Wave polarization will undoubtedly be one of the important factors in this new development."

PROF. A. M. LOW (London; from an article in *John Bull*): "Before many years are passed we are sure to have the radio serial story, and we are sure to have plays acted by radio with various incidents leading up to exciting passages which are always 'to be continued in our next.'"

# News of the \$500 Short-Wave Receiver Prize Contest

*Entries May Be Made Up to April 1, 1926, Instead of March 1—Conditions and Further Information of a Contest to Interest Amateurs Everywhere*

THE short-wave receiving set contest, announcement of which was made in the February issue of RADIO BROADCAST, has won the enthusiastic response of numerous experimenters in the short-wave field, judging from the correspondence which has come in since the announcement was made. So many complaints were received that there was not sufficient time for some of the experimenters to finish their sets for submission before the contest closes, that it has been decided to extend the time limit from March 1st to April 1st, 1926. A request by the New York representative of *Popular Wireless*, London, that the receivers of entrants shipped from Europe not later than April 1st should be considered, has been granted. It is probable that the extension date will also enable Australian short-wave enthusiasts to compete.

One of the interesting things which the contest has brought forward is the fact that up to this time there has been little or no novelty in the design and construction of short-wave receivers. The conventional types have given satisfactory results and consequently, prior to this contest, the stimulation to designing better receivers has been lacking.

According to present indications, among the contenders for the prize money will be super-heterodynes, regenerative neutrodyne and even the much neglected super-regenerative receiver. Certainly something worth while should be brought forward. In practice, however, Reinartz receivers are being used almost to the exclusion of other types. Attention is called again to the basis of points upon which the prize is to be awarded. Contestants should observe that a paramount requirement is that the receiver shall be adapted by its design and construction to practical amateur relaying. The only circuit limitation imposed is that *radiation be reduced to a minimum*. Otherwise, any type of receiver which will function with the utmost sensitiveness, stability, and reliability, is eligible for consideration.

The extension of the contest, which has been widely announced, will give contestants opportunity to do additional work, which should not be overlooked.

The basis of points is as follows:

Workmanship . . . . .	15
Simplicity of handling . . . . .	20
Ease of Calibration	
Freedom from hand capacity	
Independence of tuning and regeneration	
Low Cost . . . . .	10
Use of standard or easily constructed parts	5

Performance . . . . .	25
Overall amplification of signals	
Use in relaying	
Ability to use break-in	
Ability to cover foreign amateur bands	
Appearance . . . . .	15
Method of avoiding radiation . . . . .	10
Total . . . . .	100

Much comment has resulted from our insistence on the non-radiating feature. Certainly we are aware that there are differences between continuous wave reception and broadcast reception. The enjoyment of a broadcast entertainment can be completely ruined by a near-by radiating receiver but continuous wave reception is not necessarily impossible within range of a radiating receiver. Continuous wave reception is not the only thing to consider, however. Short waves are also used for rebroadcasting purposes and for supplying programs to broadcasting stations from remote points. A few hundred radiating receivers on short wavelengths, used for rebroadcasting purposes, would be sufficient to make these short wave radio telephone links practically inoperative. In anticipation of this problem, RADIO BROADCAST adheres to its fixed policy to discourage the use of radiating receivers on any and all wavelengths.

We have been invited to exhibit receivers entered in the short-wave contest at the Sixth Annual Radio Show and Convention held at New York under the management of the Executive Radio Council of the Second District. If a sufficiently interesting exhibit can be assembled so early in the contest, there will be an opportunity to see some of the latest designs in the short-wave art.

We have sought to make the board of judges a composite one, which will be thoroughly capable in considering all of the qualities of a receiver. You will observe that it includes practical amateurs, who have extensive experience in short wave relay work; scientists and mathematicians, who know how to measure and appraise in impersonal quantitative terms, and writers and commercial engineers who are able to judge the simplicity of workmanship and ease of construction from the point of view of the average home constructor. There are many names which we would have liked to include in the Board who were perforce omitted, lest it become too large to be efficient in its work, but we are sure that each member has a specific and definite contribution to make which should result in a fair decision from every standpoint.

That public interest and attention is turning toward short waves is no longer a debatable question. The announcement of this contest, the RADIO BROADCAST-Eveready short-wave experiments conducted with the coöperation of the National Carbon Company, the long-distance records of 2 GY have, individually and collectively, aroused so much attention that we are inclined to predict that the number of enthusiasts in short-wave transmission and reception will continue to increase with the marked rapidity of the last few months for some time yet. After all, your receiver may respond to signals coming in for distances of thousands of miles, but until you, yourself, have mastered the ether by making it subservient to the will of your own transmitter, your conquest is not complete. It is our hope that through the disclosure of a better short-wave receiver, RADIO BROADCAST may be the means of introducing you to a new phase of radio entertainment—the mastery of the ether through the use of the short waves.

## THE CONTEST

**OBJECT:** The object of this contest is to aid in the development of improved short-wave receiving apparatus, so that the possibilities of high frequencies may be more effectively studied.

**PRIZES:** First prize, \$250; Second prize, \$150; Third prize, \$100. Only one prize to a contestant.

**ELIGIBILITY:** Anyone interested in short-wave reception is eligible to compete, though no prizes will be given to manufacturers making short-wave receivers or parts therefor.

**CONDITIONS:** Each contestant must submit a complete description, photographs, and hook-up of a short-wave receiver which does not radiate. The receiver should be adapted to the entire short-wave band from 8566 to 1999 kc, although this may be accomplished by interchangeable coils. RADIO BROADCAST is permitted to request that the most promising receivers be sent to its laboratories, in order that the final award of the prize may be determined, after exhaustive tests. In addition to the prizes, RADIO BROADCAST is to be permitted to use descriptive matter, either in whole or in part, submitted by any contestant, at its regular rates.

**BOARD OF JUDGES:** The following constitute the board of judges: Boyd Phelps, Prof. Louis A. Hazeltine, Zeh Bouck, G. C. Furness, Arthur H. Lynch, Edgar H. Felix, Dr. Lawrence Dunn, and Dr. A. Hoyt Taylor.

# The Tube and Its Best Uses

*Explanations of Some General Instructions on How Best to Use Tubes—How Characteristics are Measured and Their Importance—Relative Merits of Amplifier Connections—The Facts About Tube Rejuvenation*

By KEITH HENNEY

*Director, Radio Broadcast Laboratory*

**R**ADIO receivers arrive in American homes at the present time in one of two ways, either the home buys a completed receiver or someone in the home builds it, assembling material that some manufacturer has designed and constructed.

In either case, the receiver is a static thing until the listener buys the tubes and turns on the A battery. From the moment that this final act is completed, the receiver ceases to be a mere assembly of electrical apparatus and becomes, for the time being at least, a stage upon which many interesting things happen.

Few builders, or purchasers, of radio receivers seem to realize that the tube is about the only part of the complete installation over which they have any control. The purchased set comes "without tubes" and the final contribution to the home made receiver must be tubes. These tubes must be chosen with considerable discretion and operated with care.

It is sufficient for the average listener if his set works, and under this happy condition a tube is a tube, an ingenious device that fits into a socket. Yet let something happen, a mix-up in A and B battery leads, a broken connection, a dropped tube, and the user realizes without delay that the tube is the vital thing, and that upon its proper functioning depends the success of the receiver.

For this reason this article, with those published in the December and February RADIO BROADCAST, endeavors to explain some tube information and some tube idiosyncrasies. Such information, in the words of a certain college professor "is in all the books" but many that should have noted it, have not. To judge from the enthusiastic reception given the first two tube articles, this field is a profitable one for study.

Among other things about tubes that are frequently mentioned in radio magazines and newspaper radio sections is the fact that an amplifier grid should never be allowed to go positive, and this seems a logical point of attack for the present article.

It is also stated that the characteristics of tubes as ordinarily measured are "static" and have little to do with the tube under actual operating conditions. At least one manufacturer of tube testers claims that his device measures the "dynamic" characteristics of tubes giving the lie to others whose products measure tubes statically. This particularly efficient instrument, so the manufacturer says, measures tubes dynamically because it uses a source of alternating current for the measurements, and everyone knows that tubes are alternating current amplifiers. And there you are!

Naturally, what the average listener wants is information that will aid him in operating his tubes intelligently; it matters little to him by what name you call tube characteristics, or how they are measured. He wants the "cold dope." And the experimenter—how many there are who

have requested tube data from RADIO BROADCAST Laboratory—wants to know how to measure tubes in the most approved fashion. The present article may be of interest to both of these types of readers.

With regard to static and dynamic characteristics, there is this to be said—a difference does exist between them; both are important; neither is difficult to measure. And it is doubtful if the dynamic tube tester mentioned before has anything to do with the so-called dynamic characteristics of vacuum tubes.

## WHAT IS NEEDED TO TELL TUBE CHARACTERISTICS

**A**SIDE from the tube and its accessory batteries, all that is necessary to measure static characteristics of tubes, which show in the form of curves the relations between grid, plate, and filament voltages and the corresponding currents, is a good voltmeter of double range, 0-10 and 0-100 volts, and a good milliammeter, and any one in his home laboratory can have many hours of enjoyment studying tubes by means of these instruments. With such apparatus diagrammatically represented in Fig. 1, let us carry out the following procedure:

- Measure the B battery voltage.
- Set the filament at proper voltage.
- Vary C voltage in convenient steps, measuring with voltmeter.
- Note plate current at each different C voltage.
- Plot the results similar to Fig. 2.

For 199 and 201-A tubes, the normal plate voltages are 45, 90, and 135. The C voltage may be varied in steps of 2 volts from minus 10 to plus 10. Semi-power tubes normally use 135 volts on the plate but as many as 180 may be safely used. On some tubes of this type—not of

the oxide coated filament type—plate voltages up to 400 have been used in the Laboratory with complete success. The C voltage on these tubes of the 112 type may be varied in steps of 5 volts from minus 35 to plus 5.

Now it is a common statement in published tube information that only the straight—comparatively speaking—part of this grid-voltage-plate-current-curve should be used for distortionless amplification. Any one can see that the curve is not straight at the bottom, and on page 458 of the February RADIO BROADCAST, the effect of using this part of the curve is shown. But any one can see that the curve continues to be straight beyond the zero grid line. In other words, there seems to be no reason why the grid should not be allowed to go positive. There must be a catch somewhere.

The catch lies in the fact that the method of discovering the relation between  $I_p$  and  $E_g$  (plate current and grid voltage) illustrated above does not tell us exactly what the tube will do under actual amplifying conditions. For instance, an amplifier tube always works into a load of some kind; as the telephone engineers say, the tube "looks" into a transformer, a resistance, or a pair of telephones, and the grid circuit, in the same language "looks back into" a transformer secondary, a resistance, or some combination of resistance, inductance and capacity.

Therefore, if we insert into the grid and plate circuits of the tube under test, a resistance approximating the impedance into which the tube normally looks we shall have the conditions of test more nearly like those occurring in practice. Fig. 3 contrasted with Fig. 1 shows these additions, and Fig. 4 the method of calculating the input and output resistance. The tube normally looks back into the output impedance of a similar tube which is "stepped up" by the square of the turn ratio of the connecting transformer. Fig. 5 shows how two differing impedances may be coupled together by means of a transformer. In this case  $Z_1$  may be the output impedance of a semi-power tube and  $Z_2$  the impedance of a loud speaker. If the turn ratio of the transformer obeys the formula

$$Z_2 = \left(\frac{N_p}{N_s}\right)^2 Z_1$$

or

$$Z_1 = \left(\frac{N_s}{N_p}\right)^2 Z_2$$

the maximum amount of power will be transferred; in other words, quality reproduction will result.

In connection with this formula it is well to remember that the voltages appearing on primary and secondary of transformers vary directly as the turn ratio, while the impedances which the transformer connects vary as the square of the turn ratio.

In the case of a first stage amplifier working from a detector tube—whose impedance will be

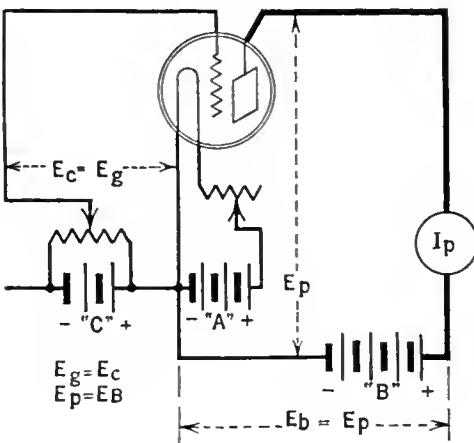

FIG. 1

Apparatus required for measuring static characteristics of tubes. A double-range voltmeter can be used to measure A, B, and C battery voltages

about 30,000 ohms—and coupled to it by means of a 3:1 ratio transformer, the tube looks back into approximately  $30,000 \times (3)^2$  or  $30,000 \times 9 = 270,000$  ohms. If the tube is the second of a two- or three-stage resistance amplifier employing high- $\mu$  tubes, the tube looks back into three impedances in parallel as shown in Fig. 4. In the case of the last tube in a set which works into the loud speaker, its output impedance will be approximately matched by the impedance of the

plate voltage is less than the B battery voltage by the drop in the load impedance. The plate current will be less naturally. When the grid goes positive it begins to draw current so that variations in grid voltage are no longer as effective in changing plate current; then these variations only produce more or less grid current.

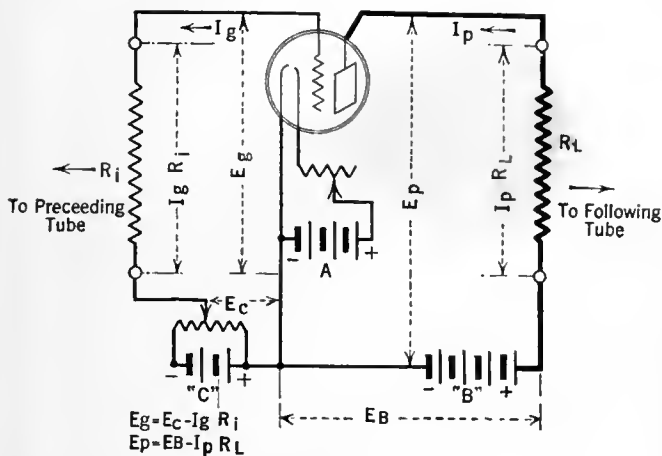

FIG. 3

To obtain the curves shown in Fig. 2 it is necessary to add resistances in the input and output circuit of an amplifier tube. These resistances simulate the impedances of the preceding and following tubes together with accessory coupling apparatus

speaker, but in intermediate stages, the primary impedance of the coupling transformer should be at least three times the output impedance of the tube at the lowest audio frequency which it is required to amplify. This means that the primary of the transformer must have 50 henries inductance at 100 cycles when working from a 201-A tube with an output impedance of 10,000 ohms. If the transformer has a "flat" characteristic at 100 cycles, the higher frequencies will be taken care of by a complicated combination of capacity and core loss in the transformer.

In other words in the first amplifier the factor  $R_L$  will be about 30,000 ohms, while in the last amplifier this factor will be about 10,000 for a 201-A and 5000 for a 112 tube.

In Fig. 3  $R_L$  and  $R_i$  represent the combined impedance of the tube and the connecting apparatus looking away from the tube under test.

Under these conditions, shown in Fig. 3, somewhat different curves result when one plots plate current against change in grid volts. In this case the plate voltage is not the B battery voltage but is less by the drop in the load resistance, and the voltage actually applied to the grid is not the same as the C battery but is less by the drop in the input resistance—when the grid goes positive.

As soon as the grid goes positive, current flows in the grid circuit, depressing the input voltage, and the plate current curve flattens out or actually drops. Distortion is inevitable because the plate current no longer is an exact replica of the applied voltage. The tops of the waves are completely obliterated and the plate current jumps about when incoming signals force the grid positive. What comes from the loud speaker differs widely from what leaves the transmitting station. Curves which show this flattening are in Fig. 2 in which the load impedance is 12,000 ohms, and many excellent curves of this nature may be found in a recent article in *Popular Radio* by Hugh S. Knowles.

What actually happens is the following: the

a tuning inductance and condenser. When the grid takes current, however, power is required, the input impedance becomes very low, effectively shunting the tuning circuit and making tuning broad.

As a matter of fact, the above experiment has not as yet measured what vacuum tube experts know as "a. c. dynamic characteristics" which show the relation between alternating plate current values as related to alternating grid volts. Some excellent curves of this type may be found in the December, 1925, *Proceedings of the Institute of Radio Engineers*. What we have measured are known as "d. c. dynamic" characteristics. Since we have used pure resistance loads, the curves for d. c. and a. c. will be the same. This would not be true had we used an inductance in the plate circuit. But the fact has been clearly demonstrated that amplifier grids should not be permitted to go positive—they should not be overloaded. The remedy, naturally, is increased C battery and this in turn necessitates greater B battery.

It seems to be a psychological fact that the average listener

In a potentiometer-controlled radio frequency amplifier, very heavy plate currents are drawn when the grid is forced positive by stabilizing adjustments.

This is due to the fact that there is very little resistance in the plate circuit of these amplifier tubes which operate under "static" conditions. At the same time another effect begins to be noticed. When an amplifier grid is negative and drawing no current, the tube input impedance is extremely high. In other words, it puts no load on the input device, say

wants louder and louder signals—he becomes radio deaf. For example the first stage in the average listener's radio life is that of a single tube which delivers its output to the listener through head phones. After a time he wants a loud speaker and he adds one or two stages of audio amplification to his one-tube set. He is satisfied with 90 volts on the plate and negative 4.5 on the grid. Then he finds that signals do not seem as loud as they did at first. So he uses 135 volts on the plate and negative 9 on the grid and installs a semi-power tube. Then he finds after a time that signals might be louder. So he goes to 180 volts on the plate and negative 15 on the grid, or to two tubes in parallel or push-pull, or to the final stage where he uses a power tube with 350 volts on the plate and about negative 25 on the grid. The more the listener gets, the more he wants. In another

TUBE	$\mu$	$R_p$	$G_m$	$\frac{\mu^2}{R_p}$	$\frac{\mu}{\sqrt{R_p}}$	CONDI-TIONS
199	6.5	22,400	304	$19.8 \times 10^{-4}$	$4.45 \times 10^{-2}$	a
201-A	8.2	12,700	660	55.3	7.37	a
12	5.6	14,000	400	15.0	3.87	b
120	3.3	6600	500	12.8	3.58	b
112	7.0	6150	1140	80.0	8.95	c
210	7.65	5100	1500	107.0	10.35	d
Mu 20	20.00	33,000	600	121.0	11.00	e

	CONDITIONS $E_g$	$E_p$
a	-4.5	90
b	-22.5	135
c	-9.0	135
d	-27.0	350
e	0.0	90

$\mu$  = amplification constant  
 $R_p$  = Plate impedance in ohms  
 $G_m$  = mutual conductance in micromhos

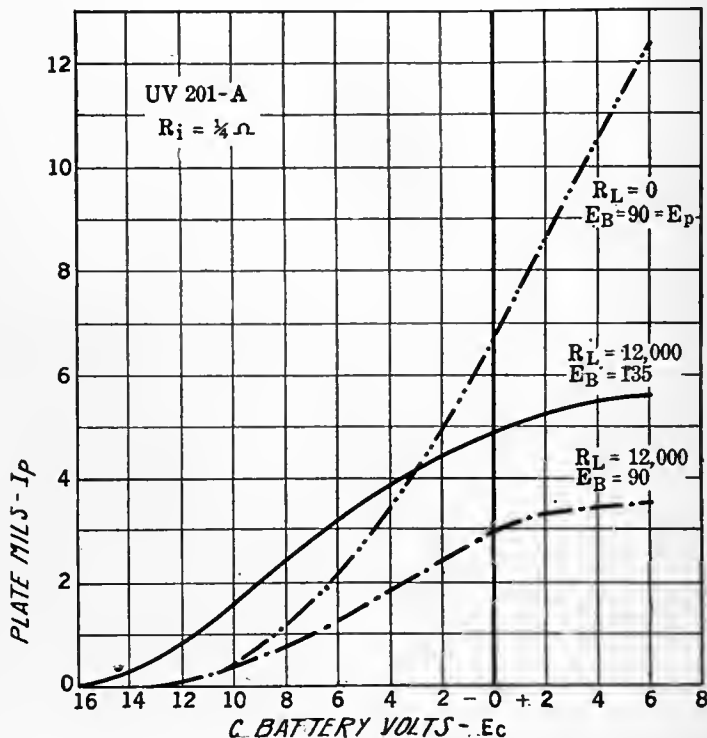

FIG. 2

What one gets by measuring tube characteristics with and without a load in the plate circuit. Note how the curve of plate current flattens out when a load is included. This is due to the fact that the effective voltage on the plate has been reduced. It shows why people get into trouble when they use resistance amplifiers with low  $\mu$  tubes and with low plate voltages

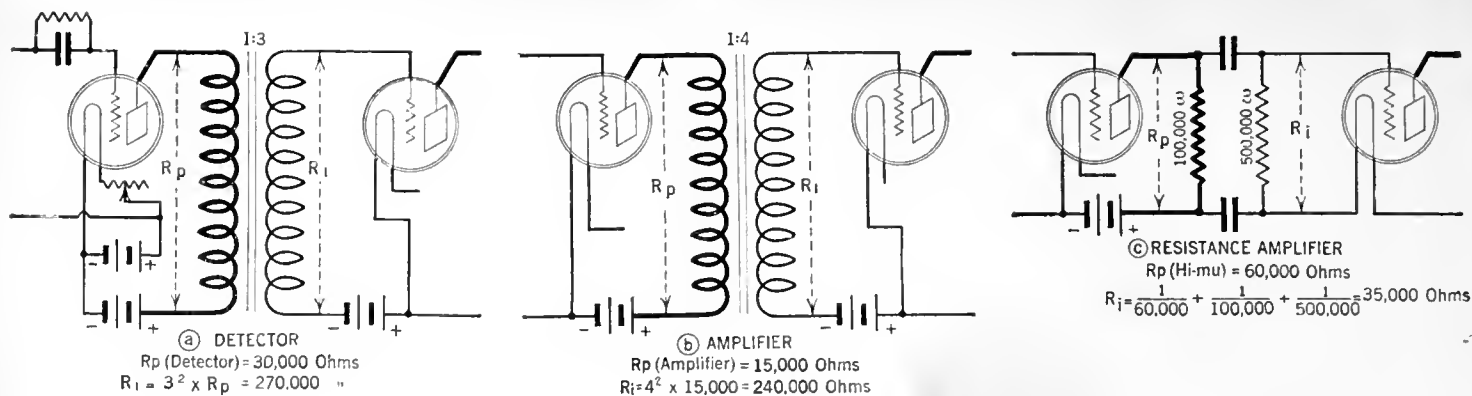

FIG. 4

Methods of calculating  $R_i$  and  $R_p$  for three general amplifier cases

direction there is an analogy—rouge blindness! The more rouge, the more . . . but perhaps we had better not go into that.

So much for distortion owing to positive grids. Too much C battery, however, will force signals to use too much of the lower part of the characteristics and will cause distortion. A load in the plate circuit, however, has the tendency to straighten out the  $I_p$ - $E_g$  (plate current-grid voltage) curve, so that the bottom of the curve is not so bad as it looks from the static characteristics.

Consideration of the curves in Fig. 5 and those in *Popular Radio* already mentioned show that the greater the impedance in the plate circuit the straighter will be the characteristic. Some loud speakers have very little impedance at low frequencies so that the curve worked over is not straight but curved and a peculiar distortion results when bass viols, or kettle drums are played. The remedy lies in a lower impedance tube, say one of 4000 ohms, and some tube manufacturers are making preparations to supply such tubes. They will necessarily have a low amplification factor and will draw considerable plate current but will be capable of delivering considerable power. Output transformers useful in overcoming this type of distortion are manufactured by the General Radio Company, and are designed to couple low impedance speakers of the cone type to 201-A tubes and to low impedance power tubes.

Among other things that are often discussed by those interested in tubes is the importance of producing and using tubes with a high value of mutual conductance. In preceding articles of this series, methods of measuring this important tube constant have been shown. Tables were given showing the value of mutual conductance of tubes recently tested in the Laboratory.

Let us examine this term and see what it

means in relation to proper tube operation. Tubes are most frequently called upon to perform one of two functions, voltage and power amplification. It is important then to know how useful a given tube will be when used as a

abbreviated to read  $G_m$  and defined as the amplification constant divided by the plate impedance.

The same mathematics, however, shows that these functions are related in the following manner:

$$\text{Voltage Amplification} = \frac{1}{2} \sqrt{R_i} \times \frac{\mu}{\sqrt{R_p}}$$

$$\text{Power Amplification} = \frac{R_i}{2} \times \frac{\mu^2}{R_p}$$

$$\text{Power Output} = \frac{E_g^2}{8} \times \frac{\mu^2}{R_p}$$

$$\text{Mutual Conductance} = \frac{\mu}{R_p}$$

The mutual conductance, then, is a measure of a tube considered without regard to the circuit in which it works, while the other facts outlined above depend upon these external conditions.

For example, the values in Table 1 are for  $\frac{\mu}{R_p}$

and  $\frac{\mu}{\sqrt{R_p}}$  and knowing the input impedance as figured in Fig. 4 and the voltage that is being placed on the grid of an amplifier, it is a simple matter to compute the power and voltage amplification and the actual power output in watts delivered to a loud speaker. It has already been mentioned that a reasonable amount of power to require from an amplifier is .06 watts which will give a good comfortable signal from an average loud speaker of the cone type without overloading distortion.

When one is interested in oscillators and modulators, for example, in a transmitting circuit, the mutual conductance of a tube is a valuable measure, but it is believed that in amplifier practice some other factor such as  $\frac{\mu^2}{R_p}$  is a better figure of merit by which to rate tubes. In England such a factor has been used for some time.

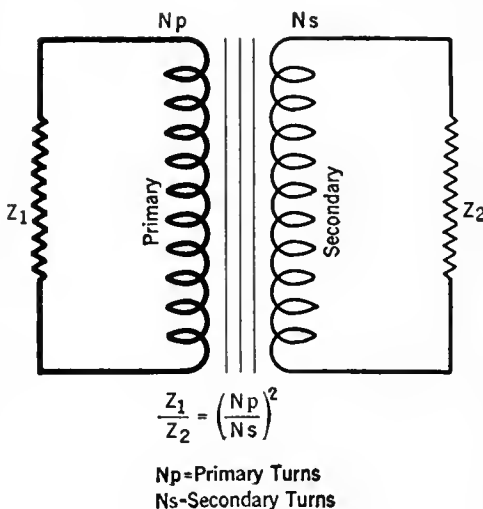

FIG. 5

How a transformer may be used to couple two impedances. As a matter of fact, such transformers in the telephone industry are called "repeating coils" since they repeat into a second circuit what goes on in a first circuit which may be of widely differing impedance characteristics

voltage or power multiplier. It is also important to know the power in watts that a given tube will deliver to a loud speaker.

It can be shown by mathematics that voltage and power amplification, and power output are related to the mutual conductance, usually

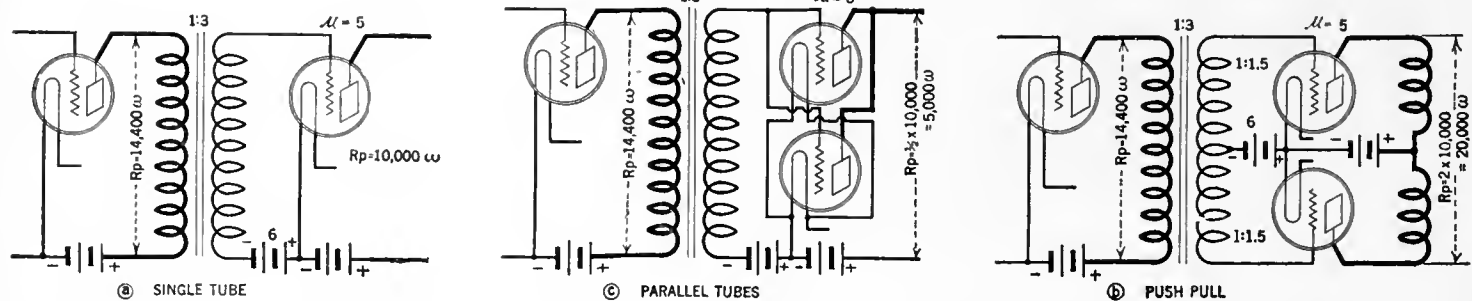

FIG. 6

Methods of calculating the important factors of three commonly used amplifier connections. One point worth noting is the fact that the push-pull input coil divides the voltage so that the effective step-up to each grid is only one half the total turn ratio of the transformer. In the push-pull circuit, the two tube impedances are in series; in the parallel case they are cut in half

THE MERITS OF VARIOUS AMPLIFIER CONNECTIONS

Now with these facts in mind let us settle a few arguments about the relative merits of a single tube compared with a push-pull amplifier or with two tubes in parallel, each working into a loud speaker designed to match approximately the output impedance of the amplifier. In Fig. 6 these three amplifiers are shown and the values of  $\frac{\mu^2}{R_p}$ , voltage amplification, and power output given. The factor  $\frac{1}{2}$  which is included in the above expressions for voltage and power amplification has not been used in these computations since in these cases a high impedance open circuit secondary is used.

It will be noted that the push-pull and parallel tube amplifier will deliver twice as much power to a loud speaker as a single tube with the same input voltage, but that the push-pull amplifier is behind the others when it comes to voltage amplification. Now, in any amplifier, the tubes, with the exception of the last one, are primarily acting as voltage amplifiers, boosting the voltage as much as possible without distortion so that the last tube whose power output is expressed as  $\frac{(\text{input voltage} \times \mu)^2}{8R_p}$  gets as much voltage input as possible. The push-pull amplifier should be used to feed power into the loud speaker, and practically any tube can be used up to that point, that is a 199, 12, or 201-A. These preliminary tubes are not required to handle much power since they are functioning primarily as voltage multipliers.

The Electrical "Shorthand" Terms Used in This Article

- Ep = Plate Voltage
- Eb = B Battery Voltage
- Eg = Grid Voltage
- Ec = C Battery Voltage
- Ef = Filament Voltage
- Ip = Plate Current
- Ig = Grid Current
- $\mu$  = Amplification Constant
- Rp = Plate Impedance
- Gm = Mutual Conductance

There is one other consideration when investigating the merits of the three amplifiers mentioned above. Owing to the electrical symmetry of the push-pull amplifier, each tube has supplied to its grid only one-half of the total input volt-

age. In other words, one can apply greater input voltages to a push-pull amplifier than to a single or parallel tube arrangement. Owing to this same symmetry, certain harmonics, due to curvature of the characteristic, are balanced out so that about 25 per cent. more overloading can be tolerated.

The parallel tube arrangement has the only advantage that its output impedance is lower than the single tube, due to the two plate impedances connected in parallel, and for this reason greater power can be delivered to a loud speaker of low impedance. Practically all loud speakers now on the market are comparatively high in impedance so the advantage in the parallel tube arrangement is not usually realized.

Since the output impedance of the push-pull amplifier is the sum of the tube impedance, a high impedance speaker must be used. If a low impedance speaker is used such as the Western

Electric 540-AW, an output transformer should be used. The push-pull amplifier has both advantages and disadvantages, and at the present time it is impossible to get input transformers that compare in quality with the best of the single-tube transformers. With power tubes of low impedance and capable of delivering relatively large amounts of power, the usefulness of the push-pull amplifier is not so great as it has been.

THE EAR AS A MEASURING INSTRUMENT

AND while we are speaking of impedance matching and voltage amplification, one should not lose

TABLE 2

	$\frac{\mu^2}{R_p}$	POWER OUTPUT =WO	VOLTAGE AMPLIFICATION=N
Single tube	$\frac{5^2}{10,000} = .0025$	$\frac{6^2}{8} \times .0025 = .01125$ watts	$\sqrt{14400 \times 3^2 \times \sqrt{.0025}} = 18$ times = 25.1 T. U.
Push-pull	$\frac{5^2}{20,000} = .00125$	$\frac{(2 \times 6)^2}{8} \times .00125 = .0225$ watts	$\sqrt{14400 \times 3^2 \times \sqrt{.00125}} = 12.7$ times = 22.1 T. U.
Parallel tubes	$\frac{5^2}{5,000} = .005$	$\frac{6^2}{8} \times .005 = .0225$ watts	$\sqrt{144000 \times 3^2 \times \sqrt{.005}} = 24.5$ times = 28.1 T. U.

MEASURING THE TUBE'S HEARTBEATS

Apparatus necessary for laboratory tests of tubes is shown here. The diagram of connections controlling this set-up of apparatus was given on page 459 of February Radio Broadcast, and involves the use of accurate resistance standards, a source of a.c. voltage, accessory batteries and switches, and several meters

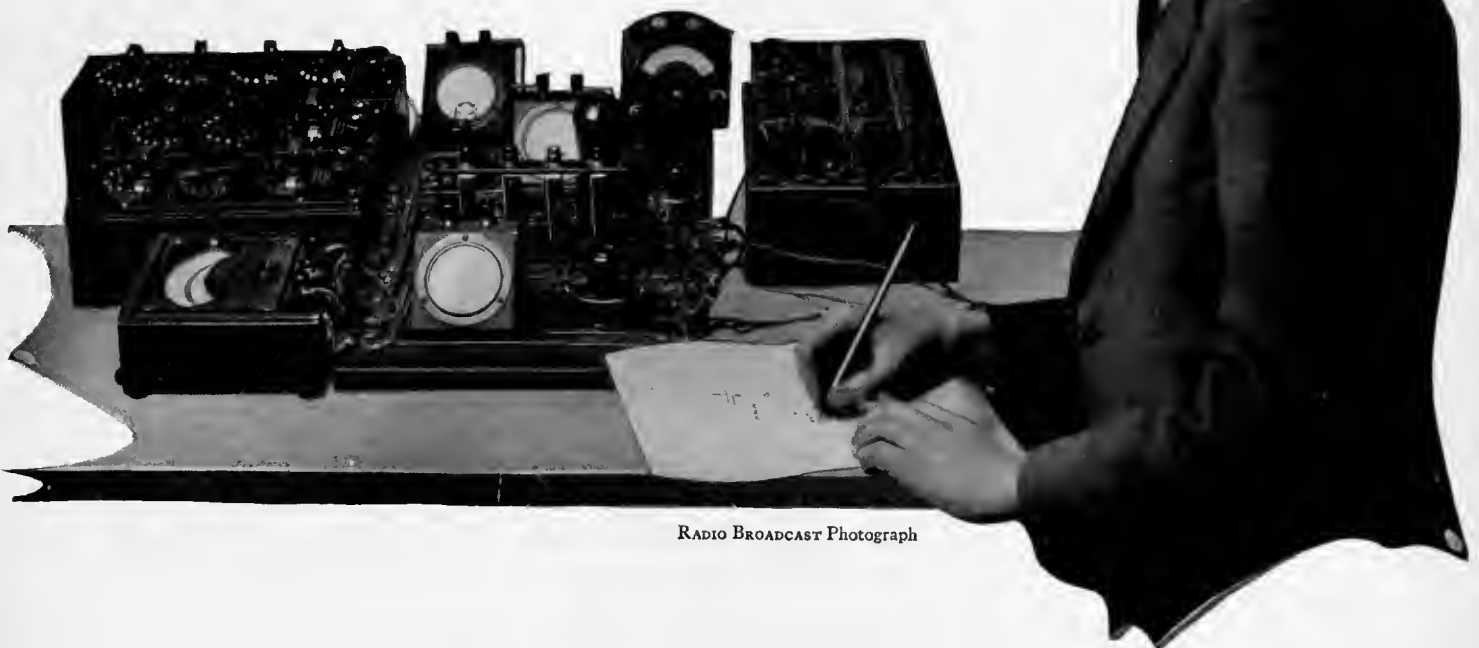

RADIO BROADCAST Photograph

sight of the fact that the ear is a deceptive measuring instrument. It hears according to a logarithmic scale, that is, a signal with one hundred times the power of another signal will sound only twice as loud. For that reason, the difference between a 3:1 and a 4:1 transformer in an audio amplifier is scarcely noticeable. For example, the parallel tube amplifier compared to a single tube has 1.4 times the voltage amplification and twice the power output. This difference in logarithmic "transmission" units is only three units, and it takes a trained ear to detect such small differences.

For the same reason the fact that it is not possible to "match" a loud speaker to a tube at every frequency in the useful audio range should not worry a listener too much. Any one can tell the difference between a terrible loud speaker of ante-quality days and a fine one, or with the latter the difference between running it from a 199 tube and a 112, but in general any one should be satisfied with an amplifier that uses two of the modern high grade transformers, or a resistance or impedance amplifier properly constructed and operated, with a semi-power tube in the last stage and proper B and C batteries, especially if this amplifier delivers its output to a cone type speaker that is properly made.

At this point it seems fair to point out that a speaker that merely uses a paper cone is not necessarily better than a speaker of the horn type. Much depends upon the element that drives the cone and upon the methods of construction and mounting. The only test is to listen to it compared with other speakers in which the listener is interested. Comparisons should be made both as regards fidelity (quality) and efficiency (volume with a given input). Some cones are remarkably inefficient.

HOW NOT TO CONTROL VOLUME

IT IS well too, to point out the fallacy of controlling volume by regulating the filament voltage of audio frequency amplifiers. As soon as the voltage is reduced to the point where volume is reduced, the impedance of the tube is increased, resulting in the dropping out of the low notes. If the low notes seem to have been lost, or the amplifier has a tendency to howl, charge the battery. Much distortion can be laid to a detector or amplifier filament that is run at too low a voltage. Reduced emission due to too low filament voltage results in distortion due to the inability of the plate current to follow the peak input voltages. Low B battery voltages also result in poor quality due to increased plate impedances.

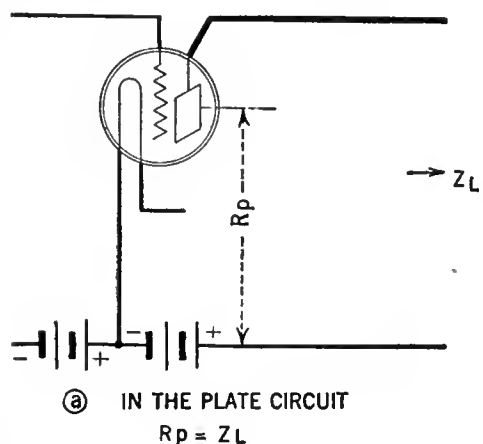

TABLE 3  
REJUVENATED TUBES

201-A		199	
PLATE CURRENT @ 90 E <sub>p</sub> , 0 E <sub>g</sub>		PLATE CURRENT @ 90 E <sub>p</sub> , 0 E <sub>g</sub>	
Before	After	Before	After
3.0	3.0	0.0	4.0
.5	5.0	0.0	3.0
1.0	9.0	0.3	4.0
0.0	6.5	0.2	3.4
0.0	2.0	0.4	4.0
0.0	1.0	2.0	3.8
3.5	2.0	0.2	0.9
4.0	1.3	0.1	3.2
2.0	5.8	1.0	4.2
0.5	5.0	0.5	3.0
0.4	4.8	2.4	4.0
3.9	4.8	2.4	dead
1.8	5.0	2.2	4.2
3.2	5.6		
4.9	4.7		
3.6	4.8		
2.0	5.5		
2.6	5.0		
1.0	4.4		
2.8	dead		
1.2	6.0		
0.2	dead		
1.5	5.0		
1.6	7.0		

Number of 201-A tubes	24
" " " 199 "	13
Average increase in 201-A I <sub>p</sub>	2.4 mls.
" " " 199 I <sub>p</sub>	2.2 "
Average I <sub>p</sub> of new 201-A	6.5 "
" " " " 199	3.5 "

Some question has been raised regarding the proper method of coupling a good loud speaker to a high quality amplifier. In Fig. 7 are shown three common systems. In any case there are two primary considerations; will the d.c. plate current of the power tube harm the loud speaker, and will the impedance of the speaker match the tube? If one uses a power amplifier as was described by James Millen in the November RADIO BROADCAST in which the plate current is of the order of 30 milliamperes, the speaker should certainly be protected.

When the loud speaker is directly in the plate circuit it looks directly into the tube impedance. This is also the case with the condenser-choke

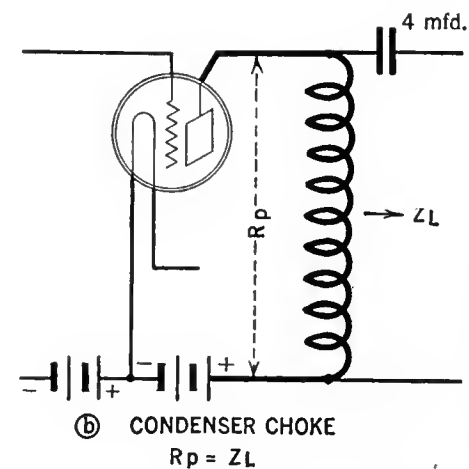

FIG. 7

Methods of coupling a loud speaker to a power tube. When the impedances of speaker and tube are approximately the same, either "a," or "b" may be used. When they differ, an adjusting coil should be used—commonly called an output transformer. Its turn ratio as controlled by the impedances is given by the above formula

system since the choke and condenser are so large that they have no effect upon the audio frequency output, and in both of these cases the loud speaker and tube impedances should be of the same order. In case of the output transformer, the impedances can be anything, pro-

vided the primary of the transformer matches the tube and the secondary matches the speaker. Either the condenser-choke or the output transformer will keep the direct plate current out of the speaker.

THE MEANING OF THE "SQUARE LAW" DETECTOR

IT HAS been stated that distortion in radio reception arises from the use of detectors which function according to a "square law." In other words the output current varies as the square of the input voltage. This statement may be discussed in the following manner. If the detector acted according to a linear law, i. e., output current directly proportional to input voltage, there would be no detection—only amplification. In other words our detector, which is inherently a distortion device, would amplify.

At the transmitting station a modulator is used which functions according to a complicated law, approximating a square law. This is distortion at the very start of the whole radio circuit. At the receiving station a detector is employed as a "demodulator" which brings the distorted signals back to their original form. The detector is

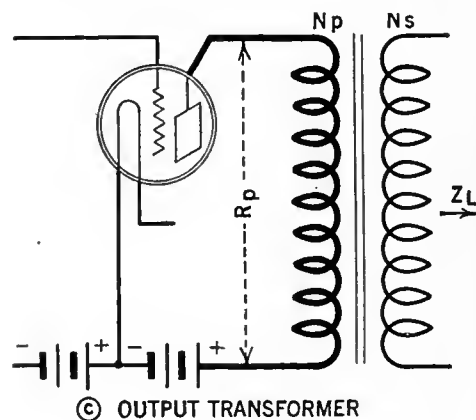

© OUTPUT TRANSFORMER

$$\frac{N_p}{N_s} = \sqrt{\frac{R_p}{Z_L}}$$

$R_p$  = Plate Impedance  
 $Z_L$  = Loud Speaker Impedance  
 $R_p$  not equal to  $Z_L$

the reverse of the modulator and may be said to introduce approximately complementary distortion. Neither would work at all unless there were a bend in the characteristic curve. As a matter of fact a crystal detector does not follow a linear law but approximates a square law. Fig. 8 shows the curve of a crystal detector and its similarity to a three-element tube curve is apparent at once. Detection takes place on the bend of the curve. If an amplifier is operated on the bend of its characteristic it acts as a detector (distorts). Recent research on detectors by F. M. Colebrook in England, shows that tube detectors are more efficient at low frequencies than at high, say 100 cycles compared with 5000, and some distortion results. The extent of this distortion may be considerable.

USE OF "HIGH-MU" TUBES

QUESTIONS are frequently asked regarding the use of tubes with a high amplification constant. These tubes are primarily designed for use in resistance and impedance amplifiers. As a matter of fact a low mu tube will not "load up" a power amplifier unless coupled to it by means of a transformer. For example, the average amplifier to deliver .06 watts power requires



at least 9 volts variation on its grid. A tube with a mu of 8 coupled by means of resistance or impedance to the amplifier cannot produce a variation of voltage greater than 8 volts and probably not over 6, so that the amplifier will not deliver its rated quota of power. On the other hand a tube with a mu of 20, or a tube with a mu of 5 coupled by means of a 2:1 transformer, can easily produce the desired change in input voltage. High mu tubes can be used as detectors and hence are useful in vacuum tube voltmeters. Their use in resistance and impedance amplifiers makes the latter practical without increasing the B battery voltage beyond reason. It must be said here that the mu of such tubes is not the only important constant. The plate impedance must be considered and, like all other tubes, the usefulness of high-mu tubes increases as their impedance decreases.

REJUVENATING TUBES

THERE are many rejuvenating devices on the market at the present time. These cannot be used with any tubes except those which have thoriated filaments. They will be of no service with the old tungsten filament 201 or 200 type tubes, or with the new UX-112, or with Western Electric tubes. On the other hand they are very efficient when worked with thoriated filaments of the 199, 201-A, 120, 210 and certain 112 type tubes. The data in Table 3 gives the result of recent rejuvenating in the Laboratory showing the plate current in milliamperes at 90 volts on the plate and zero grid

before and after the process. Fig. 9 shows several tube flashers that have been tested in the Laboratory. It will be seen that some tubes went dead in the flashing process while many gave increased plate current. At any rate the user has everything to gain, nothing to lose in the process. If his vacuum tube is no good before, it cannot be worse after the rejuvenating

process. Tubes can often be revived by burning the filament for several hours without the B battery.

WHAT "IMPEDANCE" MEANS

FOR the many readers to whom the term "impedance" is something of a mystery, the following explanation may be of aid—it is not intended for engineers. In direct current circuits—vacuum tube filament circuits, for example—the resistance controls the flow of current. In alternating current circuits, for example, the plate circuit of a tube in which there is an inductance coil, an additional factor comes into play. There is resistance and inductance, both of which tend to limit the flow of current. These two factors may be combined into a single term called impedance. If there is no inductance or capacity in an a.c. circuit, the impedance is the same as the resistance; if these other factors appear in the circuit, the resistance must be combined with them to calculate the impedance.

The impedance between the filament and plate of a vacuum tube is practically pure resistance, and its d.c. plate circuit resistance may be figured knowing the plate voltage and the plate current. As an example: If the plate voltage is 90 and the plate current 6 milliamperes, the d.c. resistance is 15,000 ohms. The impedance of the tube, however, as measured on an alternating current meter differs from this value, and since tubes are used in alternating current circuits it is not correct to use the above figure when calculating the amplification, etc., as has been done in this article.

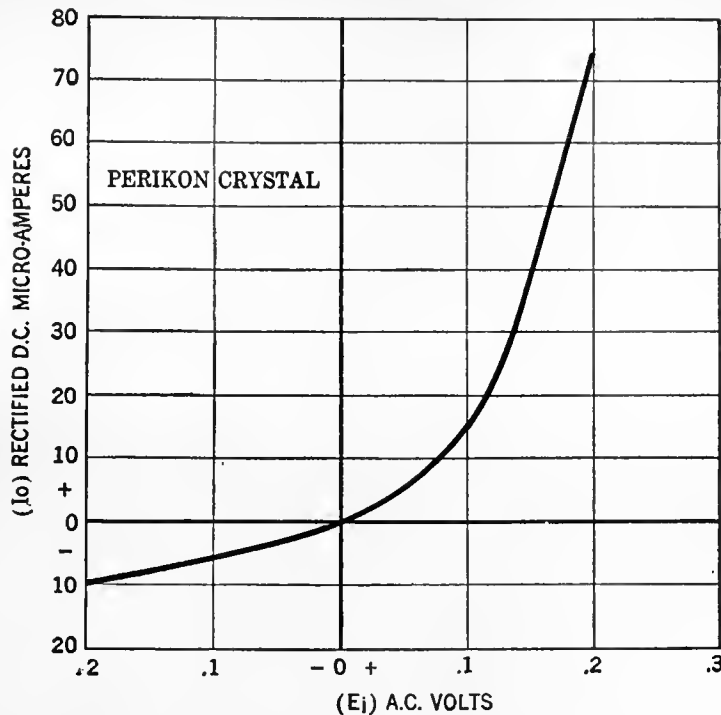
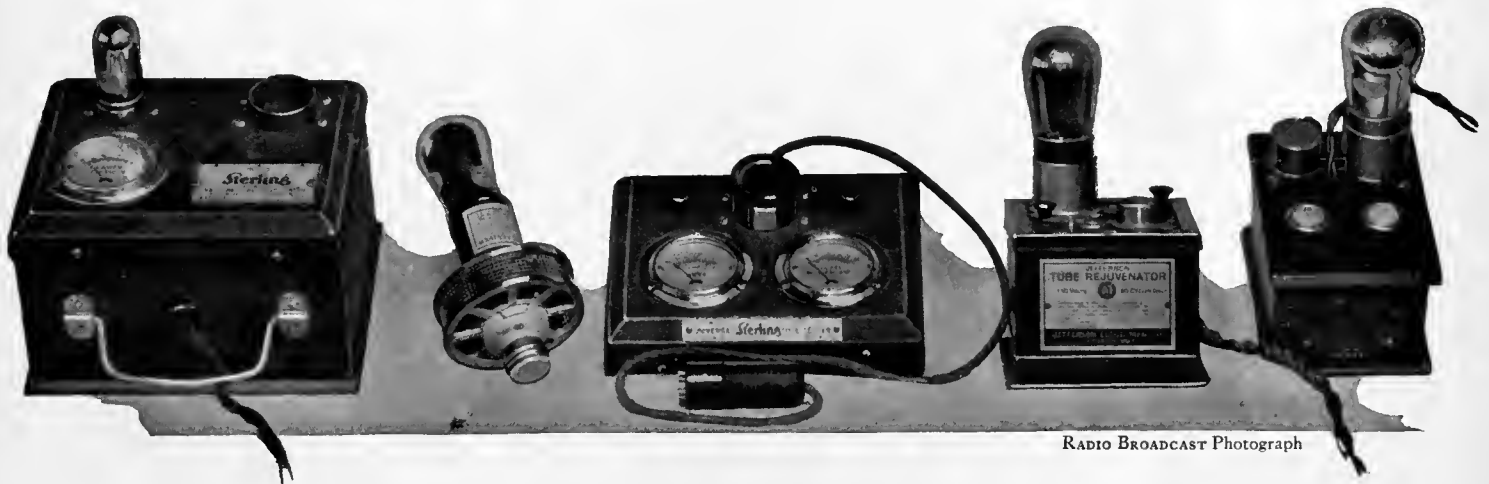

FIG. 8

This curve shows that the crystal detector follows a complicated curve—not a straight line—differing but little from the grid voltage-plate current or grid voltage-grid current curve of a vacuum tube. The apparent increase in quality when using a crystal detector is probably due to lack of tube noise introduced by a grid condenser-grid leak detector



RADIO BROADCAST Photograph

FIG. 9

A few of the tube rejuvenators now on the market. Those illustrated here are the Jefferson, the Sterling, the Burton and Rogers and the "Socket" tube reviver. The device with two meters is to measure the plate current of a tube so that one can tell if the reviving process had any effect. Another rejuvenator which is not shown here but which has been used in the Laboratory is the Hemco

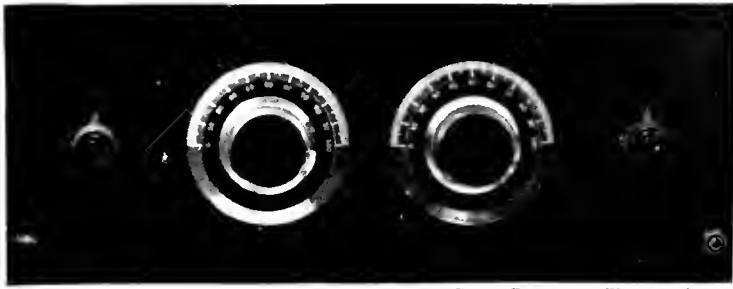

RADIO BROADCAST Photograph

WHERE TWO CONDENSERS ARE EMPLOYED

To tune the RADIO BROADCAST "Aristocrat," a very symmetrical layout may be had. In the receiver illustrated here, Silver straight line frequency condensers have been used. The panel size is 7 x 18 inches

# The "ARISTOCRAT"

Some Variations of this Popular Quality Circuit which Originally Was Described in the November, 1925, "Radio Broadcast" —the Application of Dual-Control Tuning

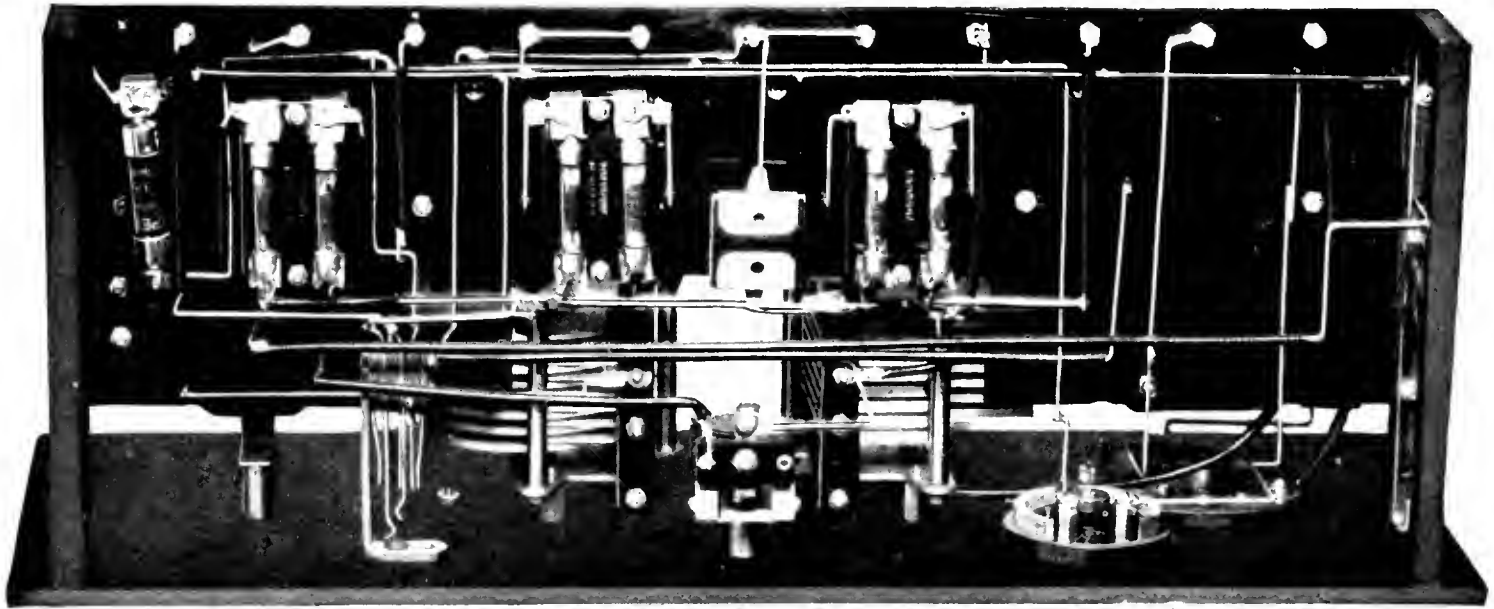

RADIO BROADCAST Photograph

UNDER THE SUB-BASE

Showing most of the wiring and the method of mounting of Daven resisto-couplers and Amperite filament control. Moulded hard rubber brackets have been used to hold the panel and sub-panel together, and to act as rests for the completed receiver. This receiver and other models of the "Aristocrat" were designed by Arthur Lynch

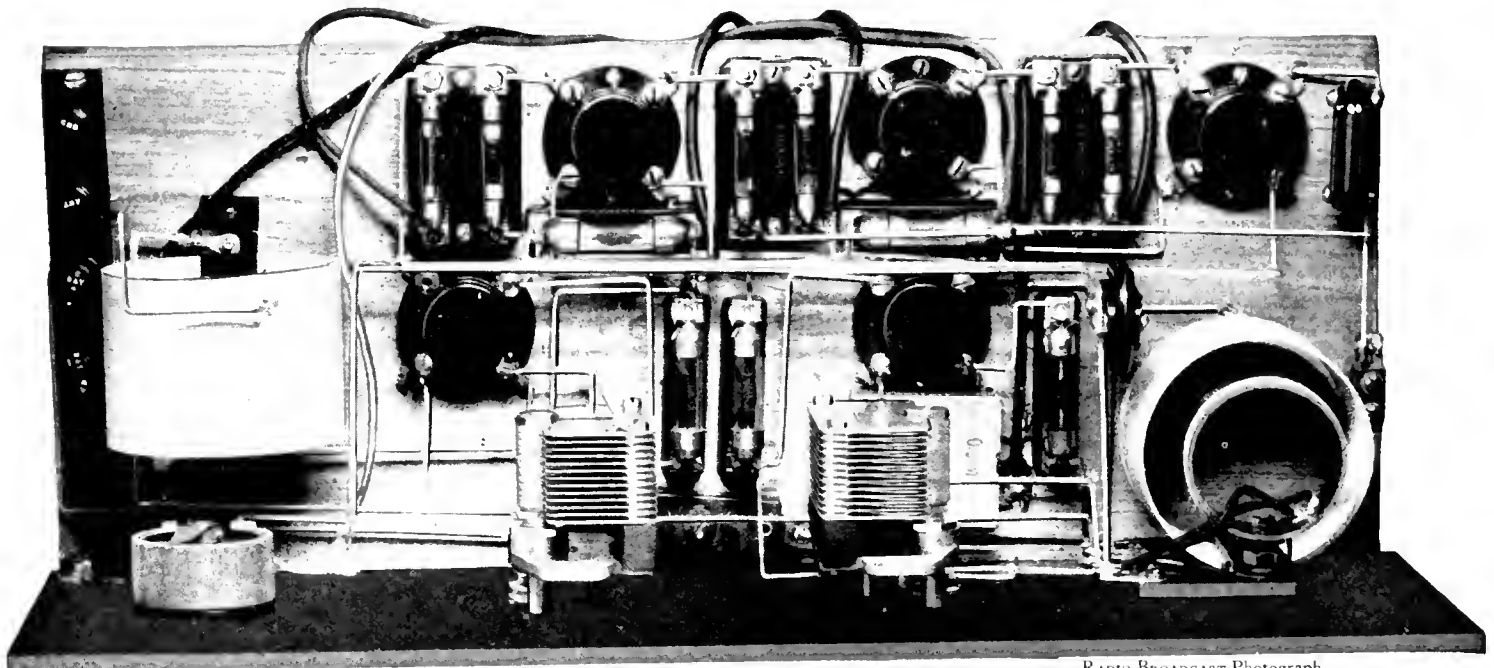

RADIO BROADCAST Photograph

A TOP VIEW OF THE TWO-CONTROL "ARISTOCRAT"

The layout, on an ordinary baseboard, and simplicity of wiring, make for compactness without stray capacities or the necessity of shielding. In this receiver the single General Radio 20-ohm rheostat is in the filament circuit of the r.f. tube. Daven  $\frac{1}{4}$ -ampere ballasts are used in all the other filament circuits save the extreme right, where the size of ballast depends on the output tube used. The plate voltage arrangement found best with this receiver was 90 on the r.f. and a 4.5 negative bias; 45 on the detector, and 135 on all three audio stages with 4.5 bias on the first two and between 9 and 11 volts on the last. The parts employed in this model are Formica panel, Kurz-Kasch dials, Silver SLF condensers and Knockout coils, Daven ballasts, fixed resistors, and resisto-couplers, Silver ux tube sockets, Tobe-Deutschmann bypass condenser X-L neutralizing condenser, Eby binding posts, Sangamo condensers, Carter switch, and Pacent jacks



RADIO BROADCAST Photograph

ANOTHER TWIN-CONTROL  
"ARISTOCRAT"

In this model the layout is altered somewhat by the use of a sub-base. This receiver is identical to the original RADIO BROADCAST "Aristocrat" for which working drawings in blueprint form are available. Amsco vernier dials, whether black, silver, or gold, show up nicely on the Insuline panel. The other knobs, left to right, are Carter antenna switch, Royalty r.f. rheostat, Hammarlund neutralizing condenser, and Eastern tickler control

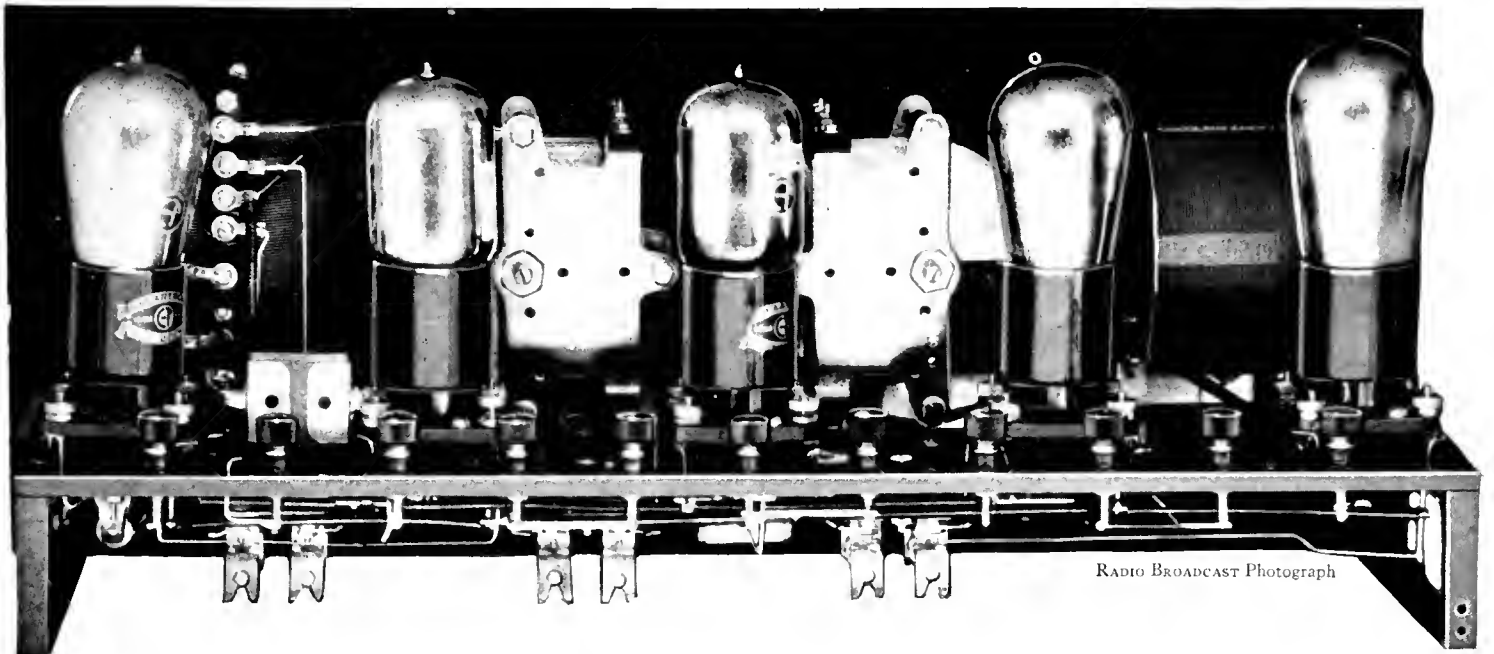

RADIO BROADCAST Photograph

A REAR VIEW OF THE SUB-BASE RECEIVER

Furnishing a general idea of the complete assembly. The tubes, left to right, are Cleartron CT-201-A Detector; two Cleartron Hi-Constron CT-101-A high- $\mu$  amplifier tubes; ux-112 Radiotron power tube; and ux-201-A radio-frequency amplifier. In this layout the resisto-couplers are hung below the sub-base rather than mounted on it as shown in some of the original models

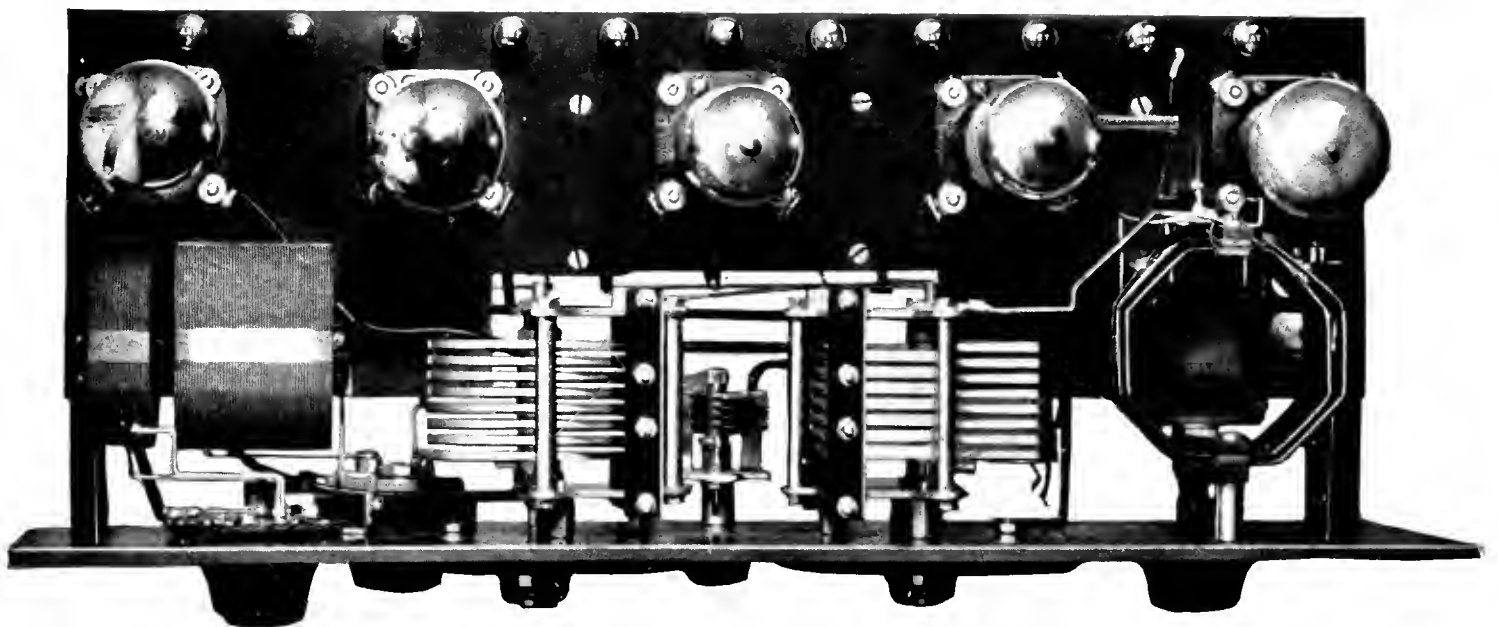

RADIO BROADCAST Photograph

A BEHIND-THE-PANEL VIEW

Of the set shown above, the layout above the sub-base, and the freedom from visible wiring this form of construction makes possible, is distinctly shown. The use of the Cardwell SLF condensers and Eastern Coils, resulted in both dials reading the same for any given station throughout the broadcast range. Benjamin cushioned sockets for ux-base tubes were found very satisfactory. In this receiver Dubilier fixed condensers were used

# Radio Sets for Light Keepers

SECRETARY of Commerce, Herbert Hoover's letter, reproduced on this page, is quite self-explanatory. There are without question, many radio receivers in working condition which are idle, and which would be of inestimable service to the lighthouse keepers at their lonely posts. We believe that readers of RADIO BROADCAST, if they know the service they can render by the donation of good receiving sets, will not be slow in rendering the aid they can so easily offer.

Readers of this magazine who have multi-tube sets which they are willing to donate to the lighthouse keepers, should pack them carefully and ship them to the Commissioner of Lighthouses, Washington, D. C., together with an explanatory letter to that official, who will see that the set is delivered to a keeper who could best use it. It is well to keep in mind the fact that the set should be capable of long distance reception,

for as every marine traveler knows, lighthouses are necessarily located at lonely and out-of-the-way spots, often far from any broadcasting station.

There are few more worthy causes than this, which RADIO BROADCAST is glad to present, and we are sure that our readers, who best know the pleasure that a broadcast receiver can bring, will not be slow in showing their generosity.

DEPARTMENT OF COMMERCE  
OFFICE OF THE SECRETARY  
WASHINGTON

January 29, 1926.

Mr. Willis K. Wing,  
Associate Editor,  
Radio Broadcast,  
Garden City, N. Y.

Dear Mr. Wing:

It is certainly very kind indeed of you to offer your help in securing radio sets for the use of lighthouse keepers.

I am sure that it is not generally realized that approximately 1400 men are employed at 700 light stations and depots to safeguard navigation. The stations extend from Unimak Pass at the entrance to Bering Sea to the extremities of United States territory in Maine, Florida, Porto Rico, and the Hawaiian Islands. Many of these stations can be reached only when the weather is favorable. At Tillamook Rock, off the Oregon coast near the mouth of the Columbia River, there have been intervals when the lighthouse tender has been unable to reach the station for seven weeks at a stretch. At Cape Sarichef, Alaska, a few years ago, the keepers were unable to receive any mail during a period of ten months.

At the best many of these men are forced to lead a dreary, lonely existence shut-off from practically all of the ordinary amusements of the average citizen. They are faithful servants of the American Government employed in most necessary work wherein inattention to duty might end in serious disaster. Their pay is very small, averaging a little more than \$100 a month. With this many of them must maintain families. Some of the better equipped keepers have put together home-made radio sets to help relieve the monotony of passing days, but others who possess the mechanical knowledge to make their own cannot afford to buy the materials. Then too, the patched together home product is not usually conducive of good results in the out of the way places where lighthouses are found.

A recent donation of twenty-five tube sets by a public spirited woman has led me to believe that perhaps there are other liberal citizens who might be in a position to help a good cause along. The Commissioner of Lighthouses will be very glad to see that any sets donated are immediately placed at the stations where they are in the greatest need, and the keeper of the lighthouse to which each set is sent will write a letter acknowledging its receipt, and this letter will be forwarded to the donor.

Yours faithfully,

*Herbert Hoover*

HH-M.



LEAVING A LIGHTHOUSE

Heavy weather often makes relief for the keeper uncertain and infrequent. There are many lonely marine outposts such as this where radio would bring much comfort and pleasure. The gift of a sensitive radio receiver would be a welcome one indeed

# The Listeners' Point of View

Conducted by — John Wallace

## Radio and the Taste of the Nation

*Comes now radio, stalking in like the proverbial last straw, to put on the complete kibosh the few straggling remnants of good taste that have managed to linger on in this Land of the Cretin and Home of the Depraved.*

—words taken from the utterances of any one of several of God's private secretaries, expressed editorially in any one of several pastel colored periodicals on the occasion of that sage's discovery of the existence of radio.

THE text of most of this pious pessimism is that the taste of the American nation is lower than that of any other similar body of men on this sphere, and that, among the agents engaged in undermining it, radio promises to be one of the most effective.

Nor is the custom of unfavorably comparing the *kulivur* of America to that of any other nation confined to the so-called intelligentsia. The habit is so widespread as to constitute almost a Dulcysism. That America, in respect to its appreciation of the "higher things" is an infant among nations is, in fact, one of the cardinal planks in the American credo. It finds place in our code of national convictions along side of such sacred tenets as "We must avoid all entangling alliances," "The French do not know how to make coffee," "Success is always the reward of effort," "Newspaper men are conscienceless scoundrels," "Abraham Lincoln was the incarnation of all virtue," and "The Japs are a dangerous little people."

It seems unfathomable on the face of it that this nation of 100 per cent. boosters should be so clamorously insistent upon deprecating the aesthetic consciousness of its citizenry. But it needs no Freud or Jung to explain this seeming paradox.

Try saying aloud; "Why, my dear, you know our people have simply no taste at all. Why any French workman, or Italian ditch digger, or German peasant, or heathen Chinese, has ten times as much appreciation of good art and good music as the average American. They seem to take naturally to the bettah things."

There now, doesn't that give you a delightful glow; doesn't that tickle your superiority complex; doesn't that neatly, though not too obviously, set you aside as one of the chosen few who appreciate the bettah things; doesn't it give you a cosmopolitan and world traveled air? That at any rate is our explanation of the national delusion that the taste of the average American is inferior to the taste of the average Anything-else.

At risk of appearing to make ourself out to be very widely traveled, we assert that this theory is pure and undiluted bunk. The "man in the street" in Naples or Shanghai or Buenos Aires or Berlin or Paris is every bit as much of a dumb-bell as "the man in the street" in Janesville, Wisconsin. In fact if any difference in their stupidity exists we should be inclined to give the American an edge more of appreciation.

Paris—the cultural capital of the world! There is more inferior and ridiculous statuary lining the boulevards of Paris for the delectation of the Parisian "man in the street" than could ever be found in a thousand miles of our Main Streets.

"Ah, but the Italians," the self abasing Amer-

icano cries out, "see how they appreciate music. It is born in them. It is part of them!" We are urged to ascend to the garlic saturated heights of the galleries of our local opera houses, and find there the Latins, the true appreciators of operatic music. And we find them there. But when? When the silly melodramas of Guiseppe Verdi or Donezetti are being yawped forth from the stage beneath.

The tired business man of Milan goes out in the evening to have his spirit refreshed by some cafe or street corner band doling out dolorous and sentimental tunes garnered from the jam pots of the "classics." The tired business man in Pittsburgh takes his musical stimulus in the form of a program of jazz. And we are inclined to attribute a superior discrimination to the Pittsburgher. His taste savours less of the maudlin and more of the virile and lusty.

We are told that the European instinctively knows a good picture when he sees it, and at the same time we find on the walls of his home, even as we do in Texas, color prints of "Aurora" or of one of Carlo Dolci's sickly saints.

But it is the man in the streets of ancient Athens who is most frequently held up to our gaze as the supreme example of the artistic cultivation of the masses. And without pausing to examine any of the numerous reference books on the golden age of Greece, we venture to guess that though civic art at that time reached a perfection never to be approached it was no doing of *hoi polloi*. The politicians of the time happened to be gentlemen of artistic leanings, so they put up public buildings that seemed to them good—and they were good. The bourgeois Athenian accepted these exquisite edifices because they were there, no whit realizing that they were supreme examples of architecture. Doubtless he admired the Parthenon, but not so much for its purity of form as for the gaudy colors with which it was then daubed.

In brief, we hold that there is no evidence to support the contention that the American taste is on a lower level than that of other countries (speaking always of the "average man's" taste.)



CECILIA HANSEN AND DR. WALTER DAMROSCH

Two artists recently heard on Sunday evening Atwater-Kent radio hours. Miss Hansen presented a violin program splendidly played, although the program numbers were hackneyed. Doctor Damrosch led his New York Symphony orchestra in a special program for the International Tests, which was unfortunately cut short on some of the stations of the "chain" by an sos call in mid-Atlantic

But let not our impassioned defense of the aesthetic discrimination of our fellow citizen lead you to suspect that we consider his taste worth a row of pins. Our argument is entirely relative; we simply believe he is no worse off than any foreigner of the same intellectual strata.

For the taste of the American nation is incontrovertibly low. It could adorn itself with a parasol and still walk under a dachshund to the small discomfiture of the beast. Our newsstands are loaded with printed rubbish, our theaters are decadent and demented, our music is punk in proportion to its popularity, and our movies . . . ah, there is exhibit A . . . fifteen years of almost unrelieved drivel.

However picture us not as sitting here gnashing our hair or tearing our teeth over the fact. On the contrary it disturbs us not a bit. If the magazines on the stands and the movies at the theaters actually represent what the great mass of the people want, so be it, and well and good. One book read for enjoyment is worth three books read for uplift.

Yet our peace of mind is occasionally disturbed by the suspicion that perhaps this nefarious fare doesn't exactly reflect the desires of the masses. Perhaps they, or some of them, could be getting a bit more entertainment out of something a little better. If so it would seem an economic waste for them to be content with inferior substitution. Which brings us back to the subject on hand—the influence of radio on the taste of the nation.

Radio, we conclude after some pondering, will have no vast and far reaching effect on the nation's taste. But far from lowering it, as has been prognosticated by the pious pessimists, it will, if it reacts upon it at all, more likely improve it. And for several good reasons.

Taste in art, like taste in anything else, is the index of our ability to enjoy the more highly civilized forms of entertainment or stimuli. Our friend Mr. Mulligan gets an immense kick out of a prize fight. Our friend Mr. Van Peyster gets an immense kick out of a George Bellow's picture of a prize fight. And though we are inclined to suspect that Mr. Van Peyster's enjoyment is a bit more acute, there is no way to prove it. More power to both of them in their varied pursuits!

But perhaps Mr. Mulligan might likewise get a kick out of Bellow's prize fight paintings if he were ever exposed to one. And then what a desirable state of affairs would have been reached: Mr. Mulligan could spend his days enjoying fisticuffs and his evenings enjoying pictures of fisticuffs and thus be assured of sixteen hours a day of happiness.

But all fooling aside, it is in just this way that radio is likely to prove of service. It is exposing the American nation nightly to better things in music than it has been accustomed to hear. Among the millions thus exposed to good music are certainly some few who were not vaccinated against it at birth, and they will, as they have been doing, "catch" it.

To say that good music is not heard by radio—as has been said by some critics—is simply to confess an utter ignorance of what is being broadcast. For good music is being broadcast, indifferently performed in many instances no doubt, but nevertheless good music.

The man in the street, like the man in the jungle, has a tremendous fear of the Unknown. Offer him an artichoke and he will bristle at the brow and foam at the mouth. Conduct a nationwide advertising campaign with the slogan,

ARTICHOKES FOR HEARTY FOLKS  
and he will deposit his pennies in the Piggly Wiggly for dozens of them.

Such names as Beethoven, or Moussorgski or Debussy formerly filled our lowbrow with wide eyed fright, gave him the blind staggers, lashed him into a frenzy of terror. And now he has found that his fears were groundless; that even the baby can listen to these names as they come in via the family receiving set, perhaps even to the tunes themselves, without dying of some mysterious blight.

His curiosity is piqued. Who were these men? Did they ever run for alderman? Could they stand a show against Irving Berlin? And lo and behold! if he has not been too thoroughly inoculated against them by heredity, he finds himself actually enjoying them. *Voila!* The deed is done! Our lowbrow has found a new source of amusement. He has not been "uplifted." He has not been "cultivated." He has simply stumbled upon something as effective in another way as a bag of peanuts, or a game of pinochle, in assuaging the griefs of this world.

And radio will be a tremendous boon to those who imagine they are already possessed of a polite and enviable taste for music. More often than not, an imagined appreciation of music is at bottom simply an appreciation of all the fripperies and gew-gaws that deck it. The cut of the soprano's gown, the twirl of the violinist's moustache, the presence of the "400", and so forth, are of greater interest to a large proportion of concert goers than the music itself.

Attention to the concert is frittered away through the eye. What with attending to the gymnastics of the conductor, the foot work of the tympanist, and the amazing alertness of the piccolo player, small part of the cerebral hemispheres is available for following the music.

The remedy, in the case of concert halls, is to darken the auditorium. But this, few impresarios have the temerity to attempt. Their business is to fill the seats, and plenty of light wherewith to peruse the programs is the demand of their clientele. Individuals feeling more rabid on the subject than we have gone so far as to protest that "no executive artist should ever be visible to the audience." We vaguely recollect that a concert hall in London made the experiment one time of screening the stage.

Radio is, of course, the complete answer to this problem. The listener, of necessity, does naught but listen. So we can not help but believe that in the long run this training in listening exclusively will have a demonstrable effect on the mass of musically inclined people.

### The WGBS Prize Play

COMES to our desk a copy of *Sue 'Em*, the radio play which won first prize in the contest recently conducted by WGBS and which was acted over the air for the first time some months ago by members of the Provincetown players.

The title page makes known that the author is Nancy Bancroft Brosius, that it is published by Brentano's, and is the first radio play printed in America.

Unfortunately (or fortunately?) we didn't hear the play presented, but we have just read it through two times—the second trip being attributable only to our burning desire to discover, if possible, why it won the prize. That discovery we have yet to make. We dismiss the most ready answer—that it was the best one submitted—as a rather too unkind reflection on the other contestants.

The characters are four: Mrs. Dorn, "middle aged and of settled disposition" her henpecked husband, the "flapper" daughter Effie, and the son Bill. The family is sitting around waiting

to go to the movies when pa finally puts in a belated appearance. Ma gives pa a good bawling out and is not at all appeased by his explanation that he was delayed by a cop who wanted to arrest him for jay walking. Pa, it seems, tried to walk into a truck which brushed by his leg.

But suddenly it is suggested to ma that the truck drivers might be sued! Then pa is quickly shifted from the rôle of doddering jay walker to that of martyr.

In a few moments he is quite dead and buried, the suit is set at \$2000 and the receipts budgeted out and all but spent. Pa is now a wounded hero and the truck driver indicted as a criminal menace to the safety of honest citizens. The dialogue working up to this right-about-face on the part of Mrs. Dorn is well written and humorous in a broad fashion.

Then the twist is introduced: Bill, the son, enters the room, disheveled of appearance and terror stricken of mien. He announces that he has been out driving in the family Ford; that a man walked right in front of his car, that he struck him, and probably killed him! The consternation of the family is augmented when Bill says they will probably be sued by the man's widow and four orphans. Ma then executes another right-about-face and discourses at length about the carelessness of pedestrians and the injustice of the widow's presuming to sue her innocent little Bill.

An amusing situation, we grant, but how was it arrived at: Bill, after witnessing his family's absurd shift of ground, breaks into merry laughter and announces that it's all a joke, he never hit anyone. This announcement, which is supposed to constitute a climax, is, as a matter of fact, a silly let down, and takes away whatever merit the play hitherto had. It is irritating as it discloses the author as trying to put one over on the audience. In other words the situation is not *developed* but *forced*. It is like killing off the husband in the third act to solve the unsolvable triangle problem.

### A Plea for More Novelties on First Class Programs

CECILIA HANSEN, violinist, sharing a program with Florence Austral, soprano, was heard in the third of this year's Atwater Kent concerts. Miss Hansen's contribution to the concert was as follows:

- a. *Poem* . . . . . Fibich  
b. *Valse Bluette*. . . . . Drigo-Auer

- a. *Méditation, "Thais"* . . . . . Massenet  
b. *Caprice Viennois* . . . . . Kriesler  
c. *Serenade* . . . . . Arensky

- a. *Humoresque* . . . . . Dvorak  
b. *Ave Maria* . . . . . Schubert-Wilhelmj

Now suppose you, gentle reader (if such there be!), help us finish this article. Turn to your nearest neighbor and ask him to "name five solos for the violin that have been massacred more often than any others by radio performers." Done? Well now we'll just bet you our Hyper-whichomodyne against your thirteenth tube that your five numbers are included in the above program.

Who was responsible for Miss Hansen's dishing out such an assortment of trite tunes we don't know, but we are willing to be quoted as saying it was a stupid move. Cecilia Hansen is in the first rank of her profession. Her skill as a violinist is not even exceeded by her good looks (a considerable tribute that). So why,



WILLIAM DIEFFENDORF

A well known performer on the musical saw who was heard during the recent International Tests from WHAZ, at Troy

oh why, couldn't we have heard something a little less threadbare from her?

Dvorak's *Humoresque*, Massenet's *Meditation*, and the rest of the above pieces have become hackneyed for the very good reason that they are beautiful tunes. So charming in themselves that they defy the efforts of the vilest cat gut scratcher to completely disguise their beauty. Ever assured of an enthusiastic reception, they have become fixtures on the repertoires of every fourth rate vaudeville or radio fiddler.

But hackneyed they nevertheless are. Of course any alert musical theorist can furnish proof beyond contradiction that a great composition can never get old, no matter how often it is heard. But, aside from theory, the facts of the case are we do get tired of hearing the same thing over and over again.

And for this reason we regretted that an artist of Miss Hansen's ability allowed these musical banalities not merely to encroach on, but to completely monopolize her program. On the strength of her skillful interpretation she could have made just as enjoyable a program of less familiar, though equally worthy, selections—and thus enriched our musical acquaintanceship, leaving these sure-fire-hits to her weaker sisters.

We ramble on at such length not because this concert alone would seem to warrant it, but because it is typical of many other offenses in kind. The John McCormack concert, for instance, was made up largely of the ditties that you, as do we, sing so effectively in the bath tub. And we are not entirely convinced that John sang them a bit better than we have ourselves under the stimulus of fragrant soap suds. Doubtless there are some more difficult tenor airs that Mr. McCormack could do more justice to than we, but they were, in the main, lopped off his program. Which seems to us somewhat of a waste—rather like using a nice shiny silver cocktail shaker to mix up the baby's barley water.

\* \* \* \* \*

After writing the above the information below came to our attention. The novelty week referred to was inaugurated last January.

Banning all musical selections that

have been "played to death" on the radio, the eight directors of the concert orchestras whose programs are featured weekly by station WRC, at Washington, will for one week include in their programs only those new-old compositions which are seldom, if ever, heard on the concert stage or on the air.

Working in cooperation with Ralph Edmunds, Program Manager of station WRC, the eight directors will search their libraries for musical compositions whose melodies lie half-forgotten on their shelves, and will eliminate from their programs any numbers that they themselves have played in radio concerts in the past year or any which they may have heard played by some other orchestra. This innovation was decided upon following numerous requests from listeners for "new" music, instead of the almost continual repetition of selections which in many cases have become prevalent during the past six months.

So far, a list of more than a hundred such compositions has been compiled by Mr. Edmunds and submitted to the directors for their consideration. Included in the programs for the "music revival" week will also be a number of original compositions which are being written by the directors and members of their orchestras. A second list of more than one hundred and fifty selections has been made, all of which are placed definitely under the radio ban for the week.

### Is It too Early for the Burlesque Program?

SOME time ago it occurred to us that radio had attained of sufficient age and accumulated enough foibles in the ageing for some intrepid station to undertake a burlesque program, poking fun at the broadcasting game and possibly effecting some reform through the medium of mild satire. As we rotated the idea in our mind we were struck by the limitless number of opportunities for screamingly funny burlesque that are offered. In fact we had almost reached the point of writing to some station director and imploring him to hazard such a program when we ran across the following article in the *New York Times*, whereupon we decided 'twere better not.

LONDON, Jan. 17.—Great excitement and fear were caused here and in all parts of Great Britain and Ireland last evening when radio listeners-in, by a comedy of errors, heard on the air the announcement that a revolution had broken out in London.

Among other things they were told that the National Gallery had been laid in ruins by an army of unemployed; that the Savoy Hotel had been blown sky high,



FRED SMITH

Formerly program director of WLW at Cincinnati, and lately the guiding spirit behind the splendid and entirely unique civic music programs sponsored by the Cincinnati Chamber of Commerce and broadcast through WSAI. Business men of that city have subscribed more than \$15,000 to support twenty monthly programs which have featured such artists as Fritz Reiner, and the Cincinnati Symphony Orchestra, Marguerite Lizenska, Mieczyslaw Munz, Francis McMillan, and Paul Althouse. Edward J. Hoff, of the Chamber of Commerce, is Chairman of the Broadcasting Committee

that the interior of the House of Commons had been bombed, and that there had been a massacre of people in St. James's Park. A realistic touch was given to the terrifying details by sounds as though of distant explosions, the tumult of terror-stricken crowds and the crash of falling buildings.

The listeners-in spread the news and soon the newspaper offices everywhere were bombarded with telephone calls from people anxious to get further details. These offices were kept busy all day today reassuring frightened inquirers, for the rumors were still circulating in country towns and villages, and the fact that bad weather delayed the arrival of the morning papers was taken by many persons as confirmation that the worst had happened.

It was learned later that Father Ronald Knox had been broadcasting from the Edinburgh wireless station a series of burlesque "news items" and it seems that many in the radio audience had failed to tune-in soon enough to hear a preliminary announcement warning that the stories should not be taken seriously.

But the British Broadcasting Company is being severely criticized for what is described as a bad joke and has found it necessary to issue an explanation to the public. It regrets that any listeners should have been "perturbed by this purely fantastic picture," but points out that preliminary warning was given that the entertainment was not to be taken seriously.

Father Knox's burlesque news bulletin was given with so many touches of humor that it seems incredible that what he said could have been taken literally, yet at least one woman fainted when she heard it.

### The Listeners Speak for Themselves

THE following statistics should be of interest. They were arrived at by a canvass of 2800 radio fans scattered through 48 states. The poll was undertaken by A. Atwater Kent of Philadelphia and its result catalogued by Carl H. Butman of Washington.

Practically all listeners agreed that there are far too many small broadcasting stations operating in the lower wave band, and that there is too little high-class entertainment, although many believe that the chain broadcasters are giving excellent service.

Lack of variety in programs and poor announcing from many stations, are given as constructive



THE CAST OF THE WGBS PRIZE PLAY, "SUE 'EM"

Recently presented at the New York station. Last year, a contest was conducted by the station and the prize for the best manuscript for the group was given to Miss N. B. Brosius, of Cleveland. In the photograph, left to right: John Huston, Eugene Lincoln, Marion Berry, and Jeanie Begg. All are members of the Provincetown Players of New York

criticisms by radio denizens of over five hundred cities and towns. "No, there is not too much classical music," 2400 reports out of 2600 state. On the other hand, there is too much jazz, according to 1420 replies out of a total of 2534 answers. Short talks and timely speeches also appear to hold fan interest, the survey shows.

Interference from various sources is noted by more than half the correspondents; only about nine per cent. of the writers claim they have no interference. Static is blamed by more than seventy per cent. of those having reception difficulties, and seventy-five per cent. of them admit that their local or near-by stations come in the best. This is believed partly due to the static handicap. Code reception still causes some interference; about a third of the fans reporting interference, say this form bothers them.

A large number insist most of the interference is due chiefly to the fact that so many stations are crowded into the wavelenghts between 300 and 200 meters. A Pennsylvania listener wished three-fourths of them would sign off for good. Some say they never try to tune-in below the wavelength of KDKA. The use of a selective set and careful tuning seems to bring in lots of little fellows pretty well, and some of them offer unique programs. This fact is pointed out by another fan, who asserts he likes some of the smaller, independent stations better than the high-powered broadcasters due to their individuality and unusual features.

One correspondent, an old time listener from Cleveland, states boldly that, although some of

the larger stations which frequently hook up on national programs with WEAf or WJZ are fine, he believes ninety per cent. of all the programs are not worth while. The ideal conditions will only be realized, he declares, when there is but one local in a city or town, and one or two good continental chains. More broadcasting of international events, conventions and really good speakers will make for greater understanding and contentment in radio land, he adds. Many of the smaller stations, he points out, put on artists from cheap vaudeville shows, whose acts and lines of patter are often offensive and sometimes obscene. His statement that the programs handled by linked stations are usually good, is borne out by approximately eighty-five per cent. of the replies filed, which endorse this type of entertainment.

A pertinent suggestion is offered by a fan who says he can't see why these chain hook-ups always work one way, that is out of New York; He would like something from Detroit, Chicago, Philadelphia and other cities broadcast over a series of stations for a change, believing there is also good talent available in those cities.

A feminine fan is willing to listen to dance music and jazz when there is some semblance of melody to be heard, but objects to tuneless selections which sound as if they were written for noise alone. She also makes a plea for variety, pointing out that a whole evening of classical music is boresome while a solid program of jazz is worse.

The ears of careless operators of regenerative

sets would certainly burn if they could read some of the caustic complaints regarding oscillating receivers. This type of set should not be manufactured, one letter protests, while another listener claims all should cooperate to suppress them or teach the owners how to handle them. Semi-technical talks on operation would help remedy this condition, he believes.

Just after Christmas for about three months, one writer says he never tries to listen-in, because the kids trying to operate their cheap "radiators" make the nights hideous until they run their batteries down or break up their sets. Another fan expresses disappointment that Secretary Hoover hasn't put a stop to the use of oscillating sets, adding that it now looks as if radio was doomed to failure in this country where it should be the best in the world. An Ohio listener says he quits in disgust every night about eight when the howlers and squealers begin. "I would gladly pay a national tax on my antenna or set," this man declares, "if we could be guaranteed from the interference of these nuisances." This man seems to have spoken for a large number of listeners.

Some of the suggestions for improving the programs call for humorous talks sprinkled in with miscellaneous matter, touching on the general request for novelties and variety, which of course make it harder than ever for the over-worked station managers. One man wonders why practically all stations open up at almost the same hour and suggests that some start earlier, say at dinner time and carry on through



THE FLONZALEY QUARTET

Heard in a recent Victor Hour, broadcast over WJZ, WGY, WRC, KDKA, and WBZ. This group of musicians is internationally conceded to be one of the most perfectly balanced chamber music organizations on the concert stage



the early evening, while others come on a little later. Perhaps they would interfere less if they operated on staggered schedules. A train dispatcher is evidently needed if they all want us to ride with them. After all, we can't ride on more than one train or listen-in on more than a single wave at a time satisfactorily.

Thoughtful members of the listeners' clan, point out that more instruction on reception is necessary; that dealers should be particular to sell correct accessories and, particularly, suitable length antennas, designating the proper installation of antennas and grounds for new comers. Incorrectly erected and poorly insulated antennas are the cause of a great amount of poor reception, several correspondents hold. Faith in fairly long outside antennas is evidently still strong, as 83 per cent. of the fans listed use them, nearly half of them being between 75 and 100 feet in length.

A few listeners admit they would prefer one or two good programs a week rather than a continuous nightly performance by mediocre talent or even fair entertainment. Many offer to pay for better broadcast programs if it is necessary, so as to eliminate the amateur and inferior stations.

The calls for silent nights were not missing, but most of the fans reporting seem able to get at least a few outside stations when they want to do so. This is perhaps because a large percentage of those writing in own three-, four-, or five-tube sets. Out of 2660 fans replying to the question, 40 per cent. operate five-tube sets, while 22 per cent. own three-tube receivers, and 13 four-tube sets. Very few boast of more tubes and even less seem content with single tubes or crystals. This would indicate that listeners are slightly better equipped than a year ago. Most of them get loud speaker volume on some station as 85 per cent. of their sets are equipped with loud speakers. Of these, horns seem still most prevalent, although the more modern types are coming into use gradually.

These folk who wrote in about their sets, appear to prefer wet A batteries, but dry B batteries, although a few have installed eliminators.

Complaints against barefaced advertising and sales talks were also registered, while protests against the conduct of announcers would make a story in itself.

### Broadcast Miscellany

A NOTABLE contribution to recent radio offerings was the series of Free Chamber Music Concerts by the Lenox String Quartette broadcast through wjz from the Music Library in New York City.

These concerts were made possible through the courtesy of Mrs. Elizabeth S. Coolidge, who has taken a great interest in the development of musical appreciation in the American people and has spent large sums of money in the advancement of the education of the people along these lines. She is the founder of the Coolidge Chamber Music Festival, which is an annual event of three or four days duration in Washington each Autumn. It is Mrs. Coolidge's aim to institute free music concerts in every city in the United States and make the public libraries the seat of musical as well as literary education. It was she who paid for these concerts and her only stipulation was that the works of at least one American composer be played at each concert.

The Lenox String Quartette is composed of



HENRY FORD'S OLD FASHIONED DANCE ORCHESTRA

Composed of cymbalom, sousaphone, "fiddle," and dulcimer, which recently broadcast an interesting program of old time dance music over WEAJ, WJAR, WEEI, WOO, WCAP, WCAE, WTAG, WGR, WWJ, WOC, WEAR, WCCO, WGN, and KSD

Wolfe Wolfensohn, first violin; Edwin Ideler, second violin; Herbert Borodkin, viola; and Emmeran Stoeber, violoncello.

A WELCOME addition to the Chicago district's dinner music programs is the offering of the KDKA Little Symphony concert through KYW. This is effected through KDKA's short wave relay system which connects that station also with WBZ and KFXX.

AMONG the novelties recently introduced was the Henry Ford Old Fashioned Dance Orchestra broadcast through WEAJ and Associates. Besides the still up-to-date violin this quartette boasts of a cymbalom, sousaphone, and dulcimer.

ONE of the best of the permanent features on KGO's program, is the concert by the station's Little Symphony Orchestra every Sunday afternoon at 3:30. The orchestra is conducted by Carl Rhodehamel. Explanatory remarks are made by Arthur S. Garbett.

TO STIMULATE a greater interest in the operations of governmental machinery and national problems, the Minneapolis League of Women Voters has arranged a series of 20 weekly talks from WCCO. These are to be given at 2:00 P. M. every Tuesday. Each week the speaker will devote five minutes to answering questions which the listeners have sent in. The subjects to be discussed are: "Is Woman Suffrage a Failure?"; "Why Vote?"; "How Can Women Help in Bringing Universal Peace?"; "How Does My Vote Affect the Home?"; "City Government?"; "State Government?"; "National Government?"; "Women in Industry?"; "Women in Professional Life?"; "The Child at Play."; "The Child at School."

OF THE stations we receive regularly on our set, we know of none that flaunts its call letters and location more frequently and persistently than WJAX at Jacksonville, Florida. Since it is a municipal station, the explanation lies, probably, in its desire to impress the name of the village on the world at large. Personally, we're over-impressed.

THE custom in Europe, we are told, is to announce the name of the station at the commencement of the program, and then to

make no subsequent reference to it. The only exceptions are Toulouse, Oslo, Rome, and Munster, where the announcers state the station's name with every single announcement throughout the program.

PROBABLY the most irritating mode of announcing in present use is that employed by WBBM, Chicago. An oh so cheery, oh so democratic voice greets the listener before each number with a "Yes sir! Yes ma'm! This is the so-and-so Company station!!!"

IN NOTING the recent high spots in radio programs we first take occasion to welcome again the Victor Hour. The series started out auspiciously with John McCormack and Loretta Bori, on whose heels quickly followed Titta Ruffo and the Flonzaley Quartette.

BUT what we consider the best news since last writing is the winning over of the Boston Symphony Orchestra to broadcasting. For the first time in its history it has undertaken to broadcast its regular winter series of twelve concerts Saturday evenings through WEEI.

The fact that season ticket holders have completely filled Symphony Hall for the last two seasons, to the exclusion of the general public, was a determining factor in causing the trustees to authorize the broadcast.

### Communications

Mr. John Wallace,  
RADIO BROADCAST,  
Garden City, New York

SIR:

I have been hoping that someone would take a crack at those announcers who urge us to "write in." Why always "in?" Can't they say "out" or even "round about" once in a while?

Also something about the announcers who only have "little" songs, "little" compositions, etc. Why not have something of a fair size or perhaps even large now and then?

I grow somewhat tired, too, of the announcers who are so sure we are enjoying their programs.  
BEECHER OGDEN.  
Pleasantville, New York.

# AS THE BROADCASTER SEES IT

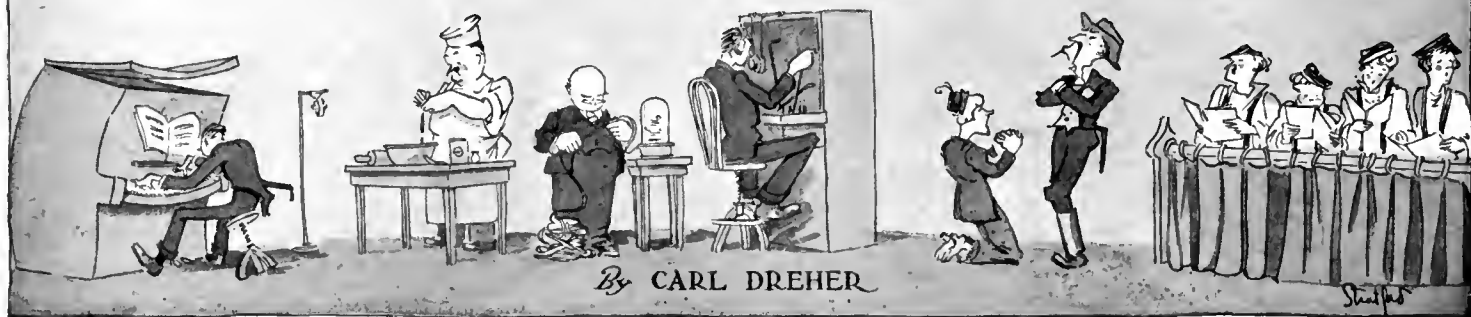

Drawings by Franklyn F. Stratford

## How Radio Has Progressed

**W**E ARE so constantly bombarded with the idea of "progress," nowadays, that we are apt to conclude that it is a notion of universal validity, which has always existed. This is an error. Progress, as a matter of fact, was first boomed in earnest by the late Victorians. No doubt it existed before, but it was taken for granted, and no one got excited over it. Presumably a civilized Greek of the BC's realized that he was housed and fed better, and more comfortably situated in general, than his remote ancestors, but he did not feel the urge to deliver lectures on the subject. As for the mediaeval mind, the idea of progress was as remote from it as oil circuit breakers.

The reason for this deplorable lack must lie in the fact that these people were not blessed and burdened with machinery. Their main concern, after the primal comforts had been taken care of, was with the things of the spirit. Hence they did not believe in progress, probably never even thought of it. For it can hardly be denied that as far as spiritual comfort is concerned, one age is no better off than another. If we assume that happiness is the aim of life—an assumption which holds good for me, and you are free to accept it or to make your own assumption, as you please—then certainly a man of this age has made no progress over a man of the age of Pericles or even Rameses. Or, if you like, go back further. These men were as free to learn, and to make love, and more free to get drunk, than we are, and they had less to worry about. I doubt if I am happier than they were, all the way back to *Pithecanthropus Erectus*. So much for progress in that sense.

But when it comes to machinery, we face a different situation. As soon as machinery enters the door, progress breaks in at the window and sits down in the best chair. There are no perfect machines, and few good ones. Some, however, are better than others. As soon as you start

in on that line, you must follow it to the grave. If you build one machine, you must shortly build another and better one, or some one else will. And so Progress has you by the neck. Progress, therefore, is a specialized and narrow thing, valid only in certain applications. To us it seems universal, because we are interested only in the things to which the concept of progress is applicable.

Of these things radio is one. Here is a field, taken by itself, in which the advances are evident to any one who has not been traveling in Tibet for the past five years. (The qualification may not be an apt one; by the time this gets into print, radio may have invaded Tibet.)

Let us go back those five years. That, of course, is an arbitrary figure. As we have often emphasized in this place, radio was very much alive before 1921; even radio telephony was not a novelty to those "in on the know," and there had been stations properly describable as broadcasting stations before that time. But it was toward the end of 1921 that radio became a subject for public participation, rather than the esoteric preoccupation of a few engineers, operators, and amateurs. And, entirely aside from the "I did it first" claimants, that is when broadcasting as we know it had its beginning.

Toward the end of 1921 I was living up on Cape Cod in Massachusetts, not far from the beach where, in his day, Henry Thoreau paced the sands and declaimed Homer to the ocean waves; but my occupations were more prosaic. I was engaged in my trade of wireless telegraphy, together with about forty other men at a transoceanic-and-marine station. Some of the operators, at their homes in the evening, listened to broadcasting from Newark, New Jersey, and spoke to me about it. I was not much impressed, having often heard wireless telephone transmission before. The trouble with it, they said, was the interference; various ship and shore stations broke in continually

while the children were listening to the bedtime story, and set them to yowling instead of putting them to sleep, and hashed up the phonograph music, which was otherwise grand. Reception, of course, was on headphones. The sets were one-and-two-tube affairs, inductively coupled, with tickler regeneration. These sets were decidedly better than the average, having been built by professional operators with all the controls necessary to achieve the best results, and perhaps a few in addition. They were not selective enough, however, to achieve freedom from interference, aggravated by the distance of the broadcasting station (some 200 miles), and the relative nearness of the spark transmitters of ships rounding the Cape and sending on 300 and 450 meters.

At this time a majority of the listeners were probably still in the skilled class mentioned above—commercial or amateur wireless telegraph operators having a little fun with telephone reception. Their number was limited, while the number of potential unskilled listeners was enormous. The latter were rapidly catching up and passed the first group very early in 1922. The receivers offered for sale to the lay public at this stage were very crude. Most of them were built for only one wavelength (360 meters), and the only variable element was to enable reception of signals of this frequency with various sizes of antennas. The best known of them was a single-circuit crystal receiver in a small box, with switch taps for varying the inductance of a single-layer solenoid. The tuning was so broad that with a large antenna—and everyone tried to get as large an antenna as possible—it did not matter much where the switch was set; everything from 175 to 500 meters came through, more or less. Then there were some better sets, also of the single-circuit type, but with a variometer adjustment and a more scientific connection of the detector circuit to the antenna inductance (through a suitable tap arrangement on the latter)

so that the tuning was as good as one could expect of such a simple arrangement. Of course the more complicated three-circuit, four-control tube receivers favored by the amateurs were available, but bold indeed was the novice who essayed to operate one right off the bat. A three- or four-control receiver nowadays usually has most or all of the dials lined up so that for a given setting of one, the others should be adjusted to about the same numbers on the scales. Besides, in the meantime the public has been educated by radio periodicals, trade catalogs, and comparison of notes on the 8:13 into town. But in 1921-22 the more complicated receivers were still operated by intuition rather than figuring, and if you lacked the intuition you had to fall back on the crystal receivers, which were therefore in the vast majority. The typical radio fan was a slightly deranged but harmless fellow who sat all evening with a pair of headphones on his ears, tinkering with a wire which he called a "catwhisker" wherewith he gently prodded a "crystal," muttering at intervals, "Maybe I can find a better spot on this d—d piece of galena." So much for the technical equipment.

And what did he hear? Mainly phonograph music riding on top of great splashes of telegraph code. Although, for a time, very respectable artists broadcast for the sheer novelty of the thing, and a ride to Newark in a Packard with a lively party at the Robert Treat following. Then, when the cute little fish began to grow up and threatened to attain the dimensions of a whale, they found it better to stay away from its aquarium. Also the music composers, and the custodians of their copyrights, began to oil their six-shooters and to sharpen the tips of their harpoons. There followed some lean years, judged by the artistic standard, but the marvel of getting voices, and a species of music, out of the air, kept the new art, not only going, but growing.

As for the broadcasting stations themselves, they were good for their day, even though they would give a modern broadcast engineer, i.e., one practicing four years later, convulsions and suicidal impulses. Their audio frequency bands were too narrow and had a great number of humps and dips, most of the tubes overloaded, the microphones had joyfully responsive resonance peaks and were addicted to blasting; the wire lines carried almost as much sixty cycle hum and telegraph clicking as modulating energy for the broadcasters who leased them. It was a grand old time, and I myself grow sentimental over it after a few drinks of ginger ale—but let us thank God that we do not have to listen to its effusions again, with our sensitized and critical ears. (We prodigies who did not know, five years ago, whether a 373-W "mike" had one button, or two, or as many as a vest.)

Let us now regard the present. We have receiving sets so selective that they clip the side-bands off the transmitted wave,

if we are not careful, and they operate on one or two tuning controls. They are a thousand times as sensitive as they need to be for anything but extreme long distance reception, and are used most of the time with the volume control near its minimum position. The output can be made as loud as the original performance in the studio or concert hall, without noticeable distortion. The users of such sets need not be cautioned to hold down the volume in order to keep the quality decent; they can get all the output the window panes can stand, without hashing up anything. As for headphones, most radio listeners no longer associate them with radio sets at all. Modern loud speakers transmit all the frequencies from 70 to 7000 per second, and if they have serrations they are not as high as a cathedral door, nor as close as saw teeth, so that the human ear, which is no precision instrument itself, takes little note of them. These sets not only work well, but they look well. The programs, in large part, are on the same level. More and more they are being supported by professional musicians, and, among the greatest artists and aggregations of artists, there are now more who have broadcast, and are going to do it again, than those who still fight shy of the microphone. Scarcely an event of public importance is run off without that little instrument in the foreground, and half of them are planned as much for the "invisible audience" as for the people physically present. As for the broadcasting stations, it is not fitting for a professional broadcaster to point publicly to their many excellencies. Nor is it prudent, because whenever he gets that way all the modulators immediately go soft, the cat gets tangled up with the ten thousand five hundred, and the breakers go out and won't go back while Lucrecia

Bori takes a top note. Still, it may be said that there are ten or twenty stations in the States which are pretty good, considering that their whiskers are not yet beginning to sprout. They are connected by quiet and well equalized lines, their frequency characteristics are satisfactory, their power is fairly adequate, their staffs know something about music and practical acoustics. All in all, the look backward is flattering, and the prospect encouraging. What with static, forced sales, copyright disputes, and lack of wavelengths, we are certainly not out of the woods, but one does not have to be a member of the Kiwanis sodality to recognize the fact that we are on intimate terms with the goddess Progress.

### Among the Broadcasters

#### WBAL

THIS new 5 kw. transmitter at Baltimore, Maryland, uses the "mixing panel" idea in solving its studio pick-up problems. Instead of employing one microphone, which must be moved to the proper position for proper balance on vocal solos with instrumental accompaniment, orchestras, and the like, WBAL utilizes three microphones with separate controls which are under the hand of the supervising operator. The electrical energy fed to the set from each of these microphones may be increased or decreased at will, without noise or other complications, so that one microphone may be cut out altogether, and another cut in, during a musical number. In other words, microphones may be changed at any time, without disturbance, the only precaution necessary being that the cutting out and swinging in must be accomplished in inverse proportion, so that the over-all volume resulting remains about constant.

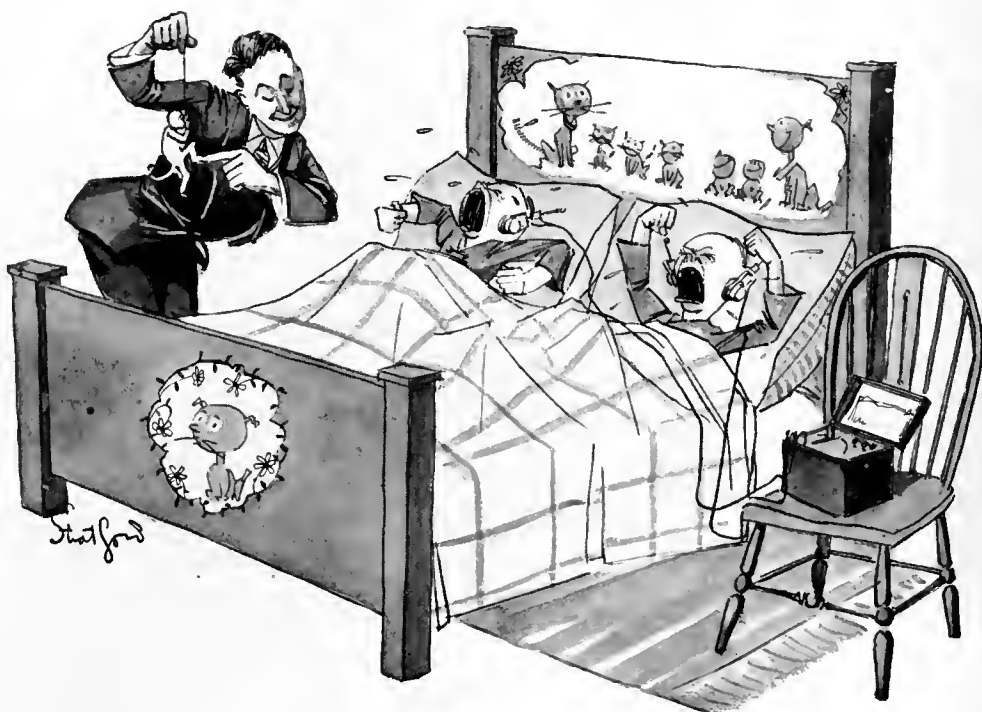

IN 1921, THE SPARK INTERFERENCE ON 360 METERS MADE THE CHILDREN HOWL

Or, the pick-up of the three microphones, or any two of them, may be "mixed" to produce a musical balance better than can be secured on one (assuming no physical movement of the microphones). I insert this last qualifying clause because it is my opinion that in a studio of moderate size with experience and reasonable control in placing of musicians, one can do as good a job with one microphone as with a dozen. One microphone, properly placed, will give as satisfactory results on small ensembles, as any combination. The advantage of the multiple pick-up arrangements is the flexibility in adjustment secured when it is found during the first number of a performance that no one microphone is properly placed. If there is only one microphone, the choice is between entering the studio during the number and moving the transmitter, which always disturbs the artists and may cause a noise on the air, and letting it ride for that number, i.e. doing a bad job for five or ten minutes, and fixing things up during the first interval. In other words, the broadcaster has to choose between the electrical devil and the deep sea. But if he has a number of microphones independently mounted and controlled, his life is made a little easier. Suppose he encounters a soprano of unknown potentialities, with the usual piano accompaniment. If she sings very loud, it may be well to place her five feet from the microphone, say, while the piano

is two feet to one side. (See Fig. 1, position A). But if she sings softly, the piano will predominate with this set-up. Well, all you have to do is place your microphone B say three feet from the lady. As soon as she starts you will know which transmitter to use, and as you have control of both it is the work of only an instant to swing in the right one. Or, it may be convenient to combine the outputs of the two microphones. This, in brief, is the system used at WBAL. With it there is much less excuse for poor musical balances, blasting, etc., than when only a single pick-up unit is available.

The WBAL announcement which has reached us merely explains the purpose of the system described, without giving the technical *modus operandi*. One way of doing it would be to use separate amplifier systems with individual gain controls of the type described in this department in the March issue ("Technical Routine in Broadcasting Stations: Monitoring"), the outputs being combined after two stages of

low power amplification. This has the advantage of including a number of parallel chains: microphone plus amplification up to the five watt level, say; and if anything happens to one of the amplifiers or microphones, that particular system is cut out as a unit, leaving one or two others still functioning. It has the disadvantage of complexity. A method of using a multiplicity of microphones, individually controlled, "inputting," as Zeh Bouck says, to a single amplifier, is shown below under "Technical Operation of Broadcasting Stations: Multiple Pick-Up."

KOA

FROM KOA, the big fellow in Denver, comes the news that the technical staff at that station are utilizing a "magic rug remedy" to keep public speakers

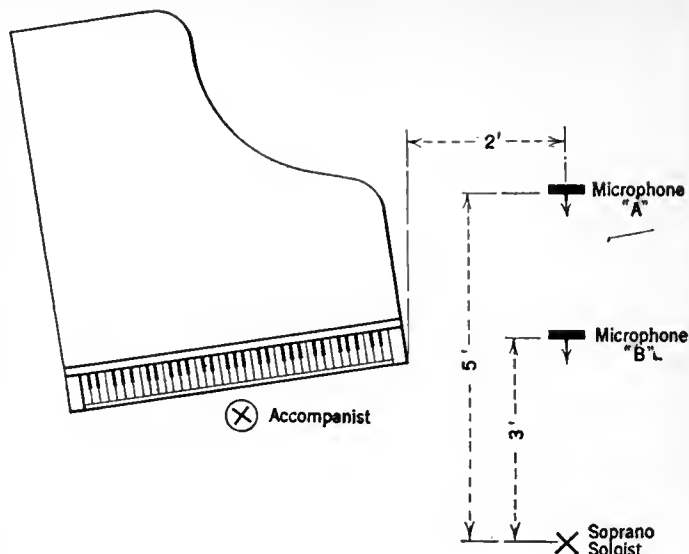

FIG. 1

within range of the microphone. The stunt is to place a small rug at the best pick-up location. After ten months' trial Alfred Thomas, the resident engineer in charge at KOA, has this to say about his device:

Not once has our magic device failed to turn the trick. Most any type of rug fills the bill if it is soft and of contrasting color with the floor. It should, however, be of small dimensions, say three or four feet. It is placed a few feet from the microphone, the distance depending wholly upon the voice of the person to be heard.

Unconsciously, the speaker assumes a position on this rug before the microphone and there remains until his remarks are concluded. Subconsciously he regards this piece of floor-covering with its imaginary boundaries, as an island of safety, and he is disinclined to venture elsewhere about the stage. As a result, broadcast listeners are enabled to hear the talk in full. Otherwise, some of the speaker's comments would be lost to the invisible audience.

Ministers, it is further stated, are the best behaved subjects before the microphone, while political speakers are the worst. How about the Rev. Billy Sunday? I have my doubts about the rug remedy if that acrobat-evangelist should be persuaded to broadcast.

Dr. D. E. Phillips, a psychologist of the University of Denver, makes the remark that "KOA's plan to prevent a speaker from taking gymnastic exercises on the lecture platform is indeed novel." With a heavy heart I must take issue with the eminent scholar of the U. of D. The stunt is a good one, but it is neither novel nor original. Public address operators in various parts of the country have been using it for years. In fact, if I am not mistaken, and I'm not, it was mentioned in the paper on public address systems by Green and Maxfield in the *Journal of the A.I.E.E.* for April, 1923.

WJJD

THE sketch shows the layout of the new Chicago studio of WJJD, with transmitter at Mooseheart, Illinois. The new quarters consist of eight rooms—the



THE MIXING PANEL AT WBAL

Part of the standard 5000-watt equipment at that station. The mixing panel for various studio microphones is that at the extreme right of the illustration

"Radio Suite"—on the twenty-fourth floor of the Palmer House, which, when the second section is completed, is expected to be the largest hotel in the world. The director of wjpd is Jack Nelson, one of the pioneer broadcasters of the Middle West.

The new studio arrangement was not thrown together haphazardly, but was carefully planned by Mr. Nelson and the architects of the building. Under these conditions, the people in charge had a relatively free hand in arranging things as past experience indicated they should be. No doubt in the future many new buildings will include broadcasting facilities in the plans; Mr. Rothaphel's New York theatre, now in process of construction, is an example of this evolution.

At wjpd there are two studios, to facilitate rehearsals and avoid delays in running off the programs. No one who has not tried to get a thirty-piece band out of a moderate sized room, with the air blank or desperately "plugged" until they could be got out and the next number set up, can appreciate what a help an auxiliary studio is to the program and operating staffs of a station. By means of buzzer and light signals the operator in the room between the studios keeps control of the proceedings. The artists in the studio are directed by means of electric signs reading, "Get Ready," "Broadcast" (in red), and others like "Too Loud," "Too Soft," "Too Much Piano," etc.

A motion picture booth is provided for taking pictures of celebrities who broadcast. Here the necessary cameras and lights are stored, ready for use and out of the way, and cables leading direct from the main power switchboard of the hotel furnish the currents necessary.

Microphone stands are considered *passé* at wjpd. Instead, the transmitters are suspended from eight-foot decorative wrought iron arms adjustable to any height and position. This eliminates microphone wires trailing around the floor, with the possibility of people tripping over them.

Loud speakers placed in the Studio Parlor, each of the rest rooms, the Director's office, and the Control Room, permit the program to be followed at all of these points. The reception parlor is furnished on the style of a well furnished living room, with chairs and lounges for waiting artists and guests. The windows between the studios and the reception room are so draped that the guests can see into the studios, but the artists, while on the air, cannot be disconcerted by a view in the opposite direction. This arrangement gets around the difficulty encountered when the studio is glass enclosed on one side, of causing the artists to feel as if they were in an aquarium.

A twenty-pair cable connects the control room of the wjpd suite to the public address control room of the hotel, so that public address service can be provided in any portion of the hotel on radio programs, and, conversely, the station can pick up broadcast material from any of the ballrooms,

dining rooms, and other points reached by the public address system. For example, any one of the five orchestras which will play regularly in the Palmer House will be available in this way.

One important item that is frequently neglected in broadcasting studios has not been overlooked in this instance. This is the matter of ventilation. It is stated that more than \$10,000 was spent for ventilation in the new quarters of wjpd.

WFGB

WFGB is a 100-watt outfit at Altoona, Pennsylvania, owned and operated by the William F. Gable Company and the Times-Tribune Company of that city. Walter S. Greevy is the director; the chief operator is William K. Aughenbaugh.

WFGB broadcasts regularly from eighteen remote control studios, over leased wires, and about once a week they pick up a special program, using portable equipment. The shortest loop is 3000 feet and the longest about 4 miles, not counting central office wiring. A. T. & T. circuits are used in the main.

The transmitter is a Western Electric 2A, with 100 watts output, fed by a 24A speech input amplifier and equipped with the 3B receiver and KS2253 power panel. There is also a set of storage batteries for plate and filament supply. The set reaches out 600 miles on evening programs.

In making some pleasant remarks about this department in its relation to broadcasters, Mr. Aughenbaugh comments on the lack of books about land line broad-

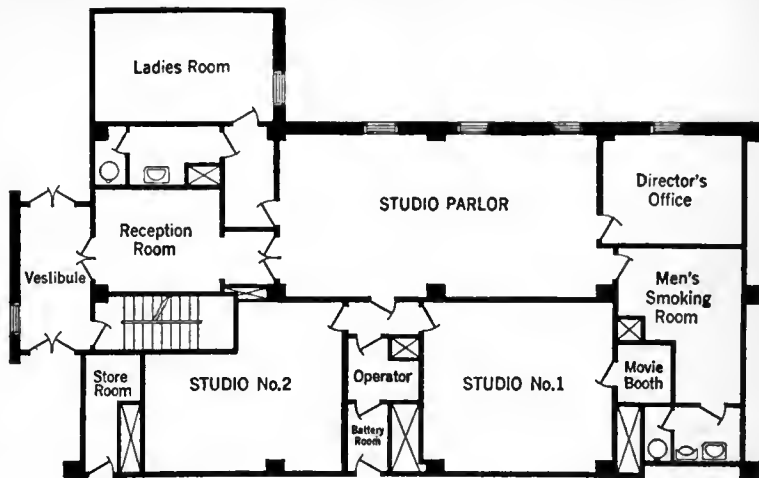

THE CHICAGO STUDIO OF WJJD  
It is located in the New Palmer House and especially designed for the station

cast transmission and broadcasting in general. There is certainly a paucity of such works. However, many valuable papers have appeared in the *Journal of the A.I.E.E.* and the *Proceedings of the I.R.E.* A list of the more conspicuous ones was given in this department in the April 1925 RADIO BROADCAST. Every broadcast engineer and operator should read the articles therein named, if nothing else. However, a complete file of the journals mentioned for 1923, 1924, and 1925 would be a good investment. There are also valuable papers in the *Bell System Technical Journal*, *G. E. Review*, and other technical periodicals. We are thinking of summarizing one such article each month, in its practical aspects, for technical broadcasters who are so situated that the originals are inaccessible to them. But we can do that only if we have reason to believe there is a decided demand for such material among our readers. How do you feel about it? You can have what you like, but you must let us know what it is.

WLS

IN A town with an ancient and Mediterranean name, Crete, Illinois, there is situated the new 5000-watt transmitter of



"THE ARTISTS FEEL AS IF THEY WERE IN AN AQUARIUM"

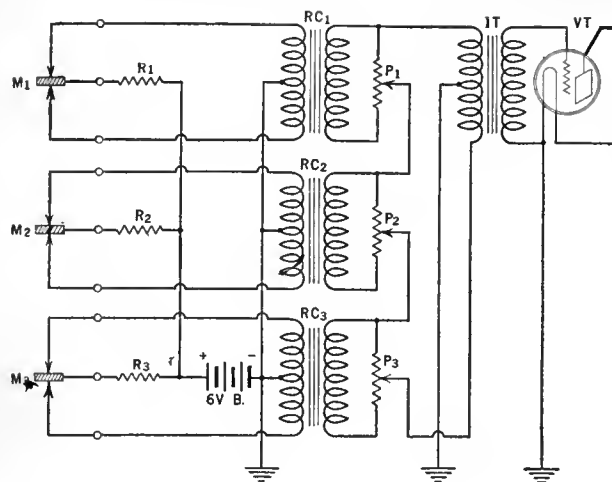

FIG. 2

WLS, with studio in the Hotel Sherman Annex in Chicago. This well-known station is maintained by the Sears-Roebuck Agricultural Foundation. Curtis D. Peck is the chief operator.

The power plant is located on a two-and-a-half acre plot on the Dixie Highway, just south of Crete. The site is landscaped, with ample drives and parking space for visitors. The lawns cover some fifteen miles of ground wire, plowed in during the period of construction of the station.

The building contains a large operating room, an office, a reception room for visitors, generator and battery rooms, switch closets, and an entrance hall. The construction is up to date in every respect, including factors affecting radio transmission. The layout and joining of metal lath, for example, is such as to minimize radio frequency losses. An elaborate water cooling system for the tubes, with provision against freezing during the winter, has been provided. The towers, measuring forty feet at the base, and two hundred feet high, are visible from the Indiana state line.

The transmitting set is a product of the Western Electric Company. The wavelength is 344.6 meters, corresponding to 870 kilocycles. The Army experimental call letters are A 2 3.

The studio on the sixth floor of the Hotel Sherman Annex was fixed up by a well-known interior decorator with the aim of expressing the radio motif (on the nature of which there may not be perfect agreement). According to an announcement, "Every piece of equipment and furniture, the walls, ceiling and lighting fixtures . . . emanate the speed, intensity, and universality of the mysterious forces of the air." Black, red, and silver are the colors, with representations of sound waves on the walls and ceilings, giving the visitor the impression that "he has stepped inside of Einstein's brain." Well, at last someone understands Einstein.

There are two studios. One is 55 feet long and 20 feet wide, for orchestras, bands, and dramatic productions; a smaller studio accommodates soloists. Separated from the larger studio by a plate glass

window is a miniature theatre which is to be open to the public. It seats about 50 people, who hear the program through loud speakers while watching the broadcasting. The usual reception room, offices, operating and battery rooms are of course included.

### Broadcast Transmitters and Tuning

**C**OMMENTING orally on the substance of my remarks on "Broad Waves and Sharp," in the March issue, in which I let loose a few growls at the broadcast listeners and operators

who labor under the delusion that a c.w. telephone station can "sharpen" its wave in some recondite manner, Mr. John V. L. Hogan, the well-known consulting engineer and Past President of the Institute of Radio Engineers, points out that there is one case in which a broadcasting station may contribute to broadcast tuning at the receiving end. That is when the carrier frequency fluctuates with modulation. This malady is probably a rare one among broadcasting stations worth listening to, but it may occur among some of the loose and flapping small time agitators of the ether, so let it be included for the sake of completeness. Mr. Hogan discussed this complaint in the September and October, 1924 numbers of *Popular Radio*. If the fluctuations are rapid enough, such a carrier will not only tune broadly, but it will be noisy. I think even in this case we should not apply the terms "sharp" and "broad" to the carrier, but should refer to its "steady" or "fluctuating" nature, as the case may be. The term "broad" should be reserved for the tuning of receivers, and the radiation of spark transmitters, with their adjustable decrement.

For that matter, the broadness of tuning of every c.w. transmitter varies with modulation. The carrier, the carrier plus the modulating frequency, and the carrier minus the modulating frequency, are the three frequencies radiated. Hence when emitting a note of high musical pitch a station should tune somewhat broader than when its carrier is modulated down in the bass. Whatever broadness of tuning is introduced in that way is a consequence of the fundamental function of the station. Again, there is a practicable form of radiation, called "single side band transmission," in which the carrier and one side frequency are suppressed at the transmitter. A substitute carrier is introduced at the receiver, and the modulation reproduced by the use of the single side frequency which is radiated. This method is very economical in that it requires a much narrower frequency band per station, and consequently allows more channels to be crowded between given

frequency limits. It has not yet been introduced into broadcasting, so this is as far as we shall let it worry us for the present.

### Radio Lingo, Past and Present

*Miscellaneous Influences: The Novice*

**B**EGINNERS in the radio art, and the public in general, say, "My radio" where initiates refer to "my receiver," or "my receiving set" or, more loosely, "my radio set." The broadcast listener is interested only in receivers, so a receiver is a "radio" to him.

The same slackness is evident in the "23-plate" nomenclature for condensers. The beginner is not interested in capacitance, which is a concept and takes some experience and thought to grasp, but he can see and count, and so condensers are sold by the number of plates rather than by the essential factor of capacity. We may expect a widening gap between the engineering and selling terminology of radio, for the engineering interests will certainly not give up their ways of calculating and designating, and the public cannot be expected to take up the engineers' way of looking at things.

Among other influences that have formed radio terminology is that of the sea. We have all heard the announcer say, "Please stand by for the next feature on our program." Now, "stand by" is a general term meaning "to be near," "to be present." As a nautical term it means "get ready," as "Stand by to launch the boats." This phrase entered radio apparently by the nautical route, but had to undergo a change in meaning to "Wait a minute; I'll be with you shortly." When two ship stations called a coast station, the land operator would tell one of them to "stand by." The early tuners had a "stand-by circuit"—a broadly tuned circuit, picking up any signal within a wide range of wavelengths. Many an old operator remembers the musical swing of Cape Race's "std bi" in the dim romantic spark days. And now the broadcast announcers have it. An honorable and manly phrase of deep salt water, it has become a prefix to jazz orchestration.

### *Past, Present, and Future*

**S**O RADIO has passed from the backyard-spark coil-coherer stage to the universal communication level, and ways of speech have changed with it. In the early telegraph days the note or tone of the signals was anything. The object was just to get a sound through. The Marconi spark coils, with their gastric growling, were supplanted by the sixty cycle spark, because sixty cycles happened to be handy. Gradually aspirations for a musical note took form and the question arose, "How's his note?" when one was speaking of a station. A decade later the question is, "How is their quality?"

when people discuss the merits of a broadcasting station—quality being the effect of a great complexity of notes and their faithful reproduction. Behind the change in phrase there is an evolution from the relatively simple to the relatively complex.

And the end is not yet. If radio movies become a reality, will radio fans be asking, "How's the visibility?" a decade or two hence?

## Technical Operation of Broadcasting Stations

### 4. Multiple Pick-Up

FIGURE 2 shows the layout of what is commonly known as a "mixing panel" for combining the outputs of several microphones. The transmitters  $M_1$ ,  $M_2$ ,  $M_3$ , are of the carbon type, and they are fed in multiple from a single battery  $B$ , each having its own resistance  $R_1$ ,  $R_2$ , or  $R_3$ , in series, to limit the d.c. through the microphone to the proper value. Each microphone feeds its audio output into a repeating coil, which is simply a 1:1 transformer, usually with a toroidal winding on an iron core, much used in wire telephone practice. This repeating coil is marked  $RC$ , with the appropriate numerical suffix. Also, the secondary of each repeating coil is paralleled by a potentiometer,  $P_1$ , etc. The variable terminals of these potentiometers are connected in series, as shown in Fig. 2. One extreme terminal goes to one terminal of the low side of the input

transformer  $IT$  ahead of the first tube; the other extreme terminal of the potentiometer chain goes to the other side of the input transformer primary. The secondary winding of the transformer goes to the tube. In the output of this tube there may be an over-all gain control, as described in the March issue, supplementing the individual gains afforded by the potentiometers.

The value of the impedances will now be given roughly. For a 6-volt battery,  $R$  will be of the order of 200 ohms, which with the 100 ohms impedance offered by each button of the microphone limits the d.c. per button to the appropriate value of 20 milliamperes. Since, for audio frequencies, the buttons are in series, a normal carbon microphone has an output impedance of about 200 ohms. This matches such a repeating coil as the Western Electric 77-A. The impedance does not change in the repeating coil (the windings being alike) hence the potentiometer across each secondary may also be of the order of several hundred ohms total resistance. The primary of the input transformer has an impedance at low frequencies of 500 ohms, stepped up to about 50,000 ohms in the secondary to match the input impedance of the vacuum tube. This transformer has, it will be seen, an impedance ratio of 100:1, corresponding to a turns ratio of 10:1, the impedance varying as the square of the number of turns.

It is important that the potentiometers should be smoothly variable, to avoid abrupt changes in the output of the indi-

vidual microphones, and that a true zero be obtainable, so that any microphone on the panel may be cut out completely if desired. Usually telephone keys are provided, so that after the gain on a transmitter has been set at zero, its circuit may be opened entirely by means of a key or switch.

The diagram shows the operation of this system with carbon microphones, but a condenser type may be used equally well provided that its associated amplifier has a step-down transformer whose output matches a carbon microphone approximately (200–500 ohms.) This output is then connected to the two outside posts of one of the sets of three, the middle post, to which the frame or diaphragm terminal of a carbon microphone goes, being left unconnected. The output of the condenser may then be mixed with a carbon microphone output, if desired. In fact, there is no reason why the outputs of several transmitters of differing frequency characteristics may not be mixed in this way, for the purpose of securing an over-all output superior to any of the component pickups. Or, in the more usual situation, several more or less identical microphones have their outputs mixed, combining pickups which differ owing to the physical positions of the respective microphones with reference to the source of sound. Finally, any microphones may be swung in or taken out at will, to suit changing conditions during a concert. All these operations are noiseless, inasmuch as the variation is carried out in a circuit carrying nothing but audio frequency currents.



RADIO GRIPPED THE FAN ASEARLY AS 1921



STATION 9ECC AT MINNEAPOLIS  
Note the chemical rectifier on the floor and the businesslike transmitter arrangement

# How a Portable B Battery Transmitter Works

*Details of Actual Operation of a Forty- and Eighty-Meter Transmitter Using B Batteries for Plate Supply—How the Record of Twenty-Six Thousand Miles Per Watt Was Attained*

By THE LABORATORY STAFF

So much for the construction for the present. Let's imagine for a few minutes that you are sitting out in the

whom we call without result. Then at 8:15 we send out a "CQ" which is answered by 9 ECC, Floyd E. Wilkins, at Minneapolis. At that time the transmitter tube, a UX-210, was drawing 22 milliamperes at 400 volts. For an hour 2 GY conversed with 9 ECC, reducing the power with the following results:

CURRENT	VOLTAGE	WATTS	SIGNAL STRENGTH
22	400	8.8	R4
16	300	4.8	R3.5
6	130	.78	R3.3
3.8	90	.342	R1 - R3

Not bad for a start! 1000 miles on .342 watts—less power than is taken by the average receiving set.

On the 15th at 9:32 p. m. E. S. T., the same stunt is repeated. 2 GY connects with 8 BZK, Paul Roth, Cleveland, using 40 mls. at 500 volts and power is reduced as follows:

WITH the approach of the International Tests and receiving conditions in Garden City nothing to brag about, it became necessary to make arrangements for an expedition to the wilds of some "blooperless" land. The problem of communication with Headquarters was a serious one indeed, for there was no telling where the expedition might lead. There seemed but one solution—amateur radio.

What the Test committee needed was a light, easily portable transmitter and receiver that could be transported with its power to points unknown with the assurance that pressing the key in the wilds would awake activity in Garden City.

For some time the Experimental Station 2 GY operated by RADIO BROADCAST Laboratory and the National Carbon Company had been the scene of much activity on short waves and low power. A circuit described in the January magazine by Niklaus Hageman had proved quite successful but secured a perfectly steady note at the expense of greater plate currents, and for hauling a transmitter to distant points, a foolproof, and especially a very economical circuit was essential.

radio shack at 2 GY with the operators, about to try the new transmitter. It is to get its power from batteries; storage battery to light the filament of the tube, B batteries for plate supply, for it is obviously impossible to carry generators to the country and who can predict the kind of power available from the lighting mains of Podunk?

It is 8:00 p. m. on the night of December 11th and Operator Mann (Mn) is at the key with Bob Blanchard standing by to throw switches and be generally helpful. The air is filled with 40-meter stations and among them is 9 DDE, John Wilcox, Chicago

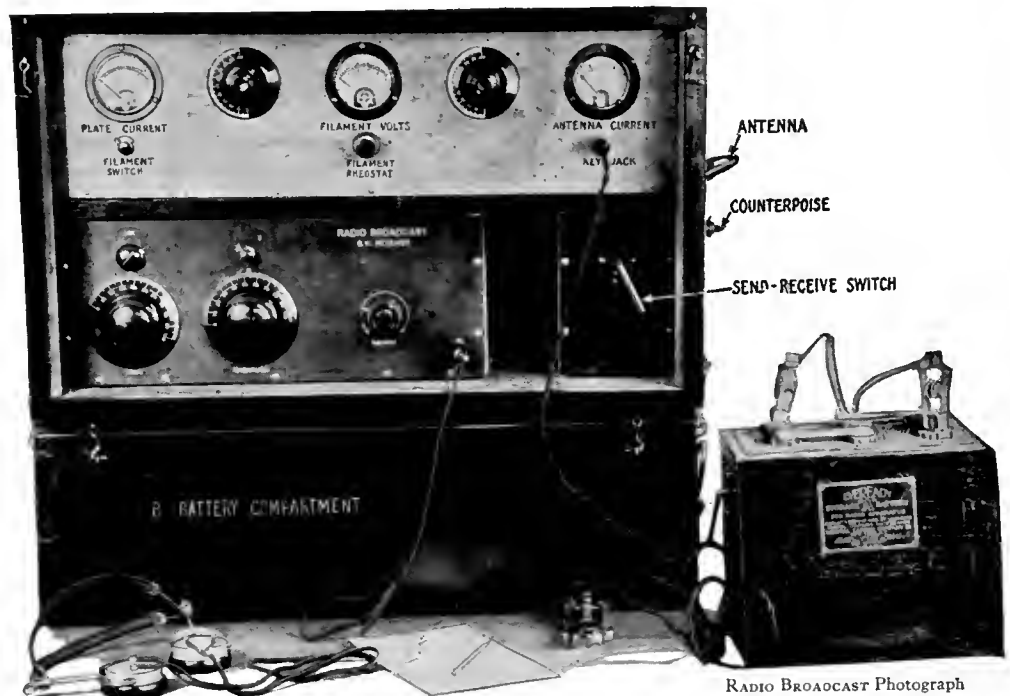
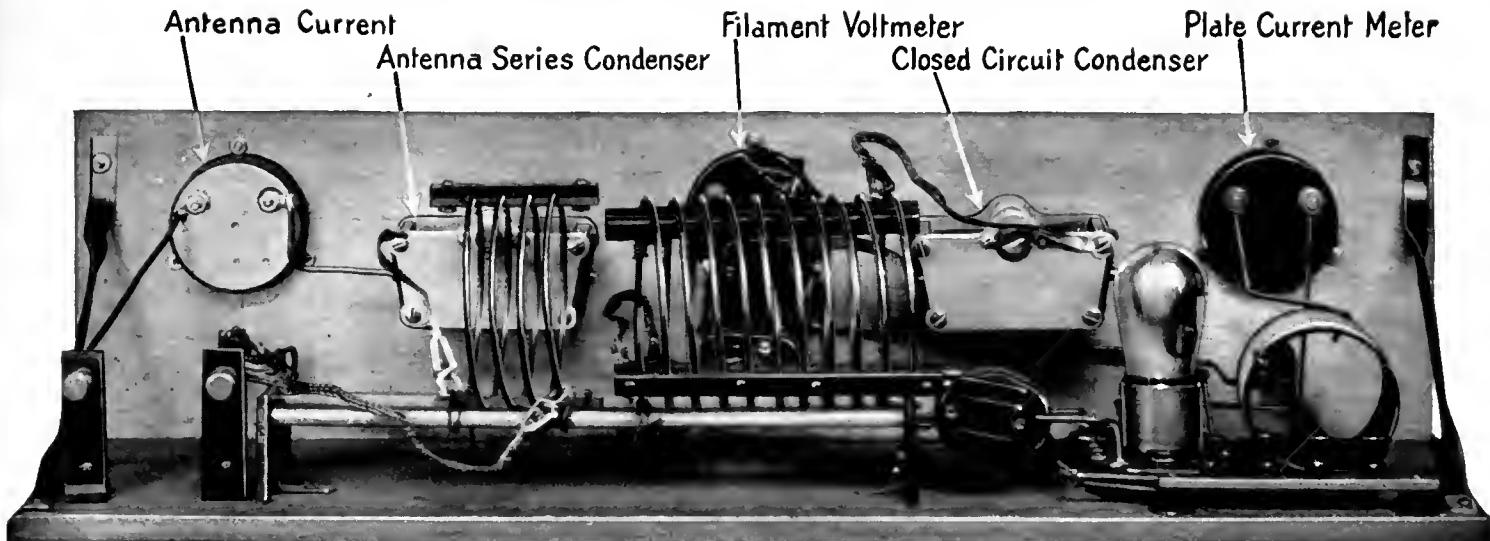

FIG. 1

Transmitter receiver and B battery compartment complete. Space is provided for ten standard receiving B batteries totalling 450 volts. The throw-over switch is unnecessary if an additional antenna is provided for receiving. The same batteries can be used on both transmitter and receiver if proper precautions are taken





RADIO BROADCAST Photograph

FIG. 2

A rear view of the transmitter showing location of component parts. The inductance coils are strapped to two dowel rods and kept away from metallic objects

CURRENT	VOLTAGE	WATTS	SIGNAL STRENGTH
40	500	20	R6
30	400	12	R6
15	320	4.8	R4
8	130	1.4	R3

At this point, local interference prevented going lower in power, but the meters on the transmitter could not read much lower anyway!

On December 16th at 8:18 p. m., 2 GY connected with 9 DCG, Frederick G. Braig, Rockford, Ill., and with an input of 1.8 watts (10 mls. at 180 volts) he said signals were audible all over the room.

At 10:05 p. m. on the night of December 17th, communication was established with 9 CCQ, Vere Davis, at Braymer, Missouri and the first of a long series of tests was carried out. That night 2 GY was using a Sea Gull 201-A tube as follows:

CURRENT	VOLTAGE	POWER	SIGNAL STRENGTH
19	290	5.5	R3
13	200	2.6	R3
7	120	.84	R2
4	75	.3	R2
1	40	.04	R1

A message was given to 9 CCQ at .3 watts which he received perfectly. Arrangements were made by wire to communicate nightly on low power. He was using three 201-A tubes with 250 volts of B batteries, no meters or any other means of indicating resonance in the antenna.

Beginning December 21, a nightly schedule was maintained with 9 CCQ except when weather conditions prevented, until January 5th when it was necessary to test the transmitter in the field. During this time communication was held many times with other stations with a maximum input at 2 GY of 20 watts. Schedules with 9 CM, Edward N. Fridgen, L'Anse, Michigan and 9 ECC proved conclusively that battery operated sets could be depended upon for consistent work.

and parallel with a metal roof not more than 20 feet from the ground. Strong signals were received at 2 GY in the daytime and at night until 10:00 p. m. when interference and the skip distance made further communication impossible on 40 meters. At 80 meters, however, communication was easily accomplished. During the International Tests, the receiver and transmitter, set up in a farmhouse miles from anywhere, provided the only means of communication with Test Headquarters.

Now all of this low power work was done without special arrangements. After communication had been established, the power could be reduced, and often 2 GY got into communication directly on low power. The antenna system was amusing—a single wire poorly insulated, neither vertical nor horizontal and only about 35 feet long. The single wire counterpoise ran in a direction opposite to the antenna and likewise was not insulated. Antenna currents were never over .3 amperes.

All of which shows that on 40 meters,

INSTALLING THE PORTABLE TRANSMITTER

AT PATCHOGUE, Long Island, 40 miles from Garden City, the transmitter was installed in a hotel room with the antenna against a metal building

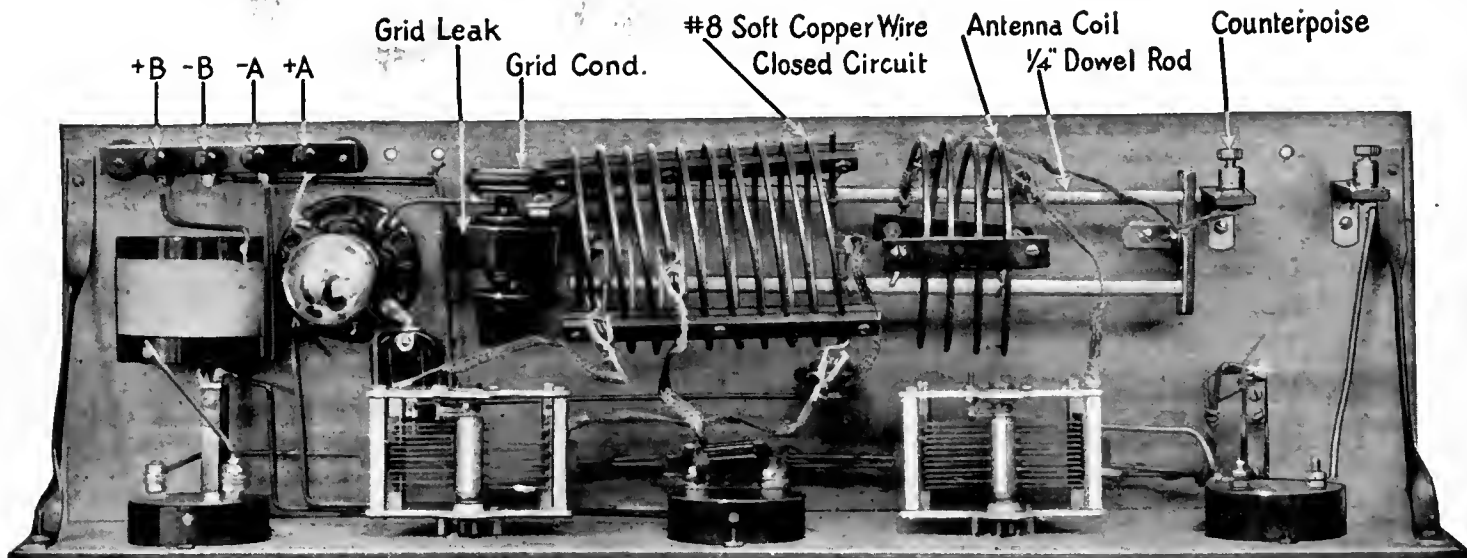

RADIO BROADCAST Photograph

FIG. 3

Another view behind the front panel giving an idea of how simple the whole transmitter is

there is no reason why any one cannot be in communication with any one else without a lot of expensive apparatus. Witness the fact that with 9 ccq, a power input of .04 watts was successful in maintaining communication over a distance which represents a record of 26,500 miles per watt. It required less power to transmit the messages than it did to receive them.

The photographs of the transmitter should give all the constructional details that are necessary and the simplicity of the antenna throwover switch is shown in Fig. 3. The plate batteries are contained in the lower compartment as shown in Fig. 4 and the whole outfit can be set up for operation in less than five minutes. All that is necessary is to remove the front board which has on it the key, plug in the A and B battery cables, throw a wire over a tree and spread on the ground the counterpoise—or use the automobile as a counterpoise—tune the antenna and closed circuits by means of the proper condensers until maximum current is obtained on the wavelength desired. The current on inputs up to 20 watts should not be high, at least not over one half ampere.

DATE	TIME	STATION	DISTANCÉ	WATT INPUT	MILES PER WATT
11/13	9:35 P.M.	4 DO	745	14.4	51.6
11/13	11:55 P.M.	9 DZN	970	6.7	145.0
11/14	12:35 A.M.	9 AJI	750	6.7	112.0
11/23	9:45 P.M.	9 DSL	860	10.8	80.0
11/23	10:00 P.M.	9 TJ	1080	10.8	100.0
11/23	10:10 P.M.	9 DXX	860	10.8	80.0
11/24	1:10 A.M.	9 ECL	1080	10.8	100.0
12/11	8:15 P.M.	9 ECC	1030	3.42	3000.0
12/15	9:32 P.M.	8 BZK	600	1.01	580.0
12/16	8:20 P.M.	9 DCG	740	1.80	410.0
12/17	8:40 P.M.	9 CBZ	700	.21	3500.0
12/17	10:00 P.M.	9 CCQ	1060	.04	26500.0
12/24	9:00 P.M.	9 CCQ	1060	.11	9650.0
12/29	8:40 P.M.	9 DIB	860	17.0	50.5
12/29	9:40 P.M.	9 BAL	860	17.0	50.5

If the current is higher than .5 amperes, more wire should be added to the antenna to increase the radiation resistance. Quite often it is impossible to raise any one on .5 amperes, but adding ten feet to the antenna will decrease the current to .2 with the result that good distance can be worked.

Sangamo condensers will stand voltages up to 1000 volts, provided of course that the currents are not high. Ordinary receiving condensers will serve as tuning capacities. Practically any tube will do. At 2 cy excellent results have been obtained with the standard 201-A tube of various manufacturers. A Ureco 112 tube

is practically the equal of the uv-210 tube which requires more filament current.

The center tap to the closed circuit inductance which completes the Hartley circuit is variable and should be near the grid end of the coil for maximum efficiency. Moving it toward the plate end will increase the power taken by the tube without much increase in the power taken by the tube and with little increase in antenna current. Only two meters are essential and one of these can be avoided if a small flash-

light bulb is used to indicate antenna resonance. This was explained in the January article in RADIO BROADCAST by Nicklaus Hageman. If a 201-A or 112 tube is used, the filament voltage should be only high enough to insure that the maximum efficiency is being obtained. This can be obtained by watching plate or antenna current meters and varying the filament rheostat. If a 210 tube is used, it may be run on 6 volts without a rheostat—and naturally no filament voltmeter is necessary.

Regardless of the fact that no especial insulation has been used at 2 cy, the antenna-counterpoise system should be as

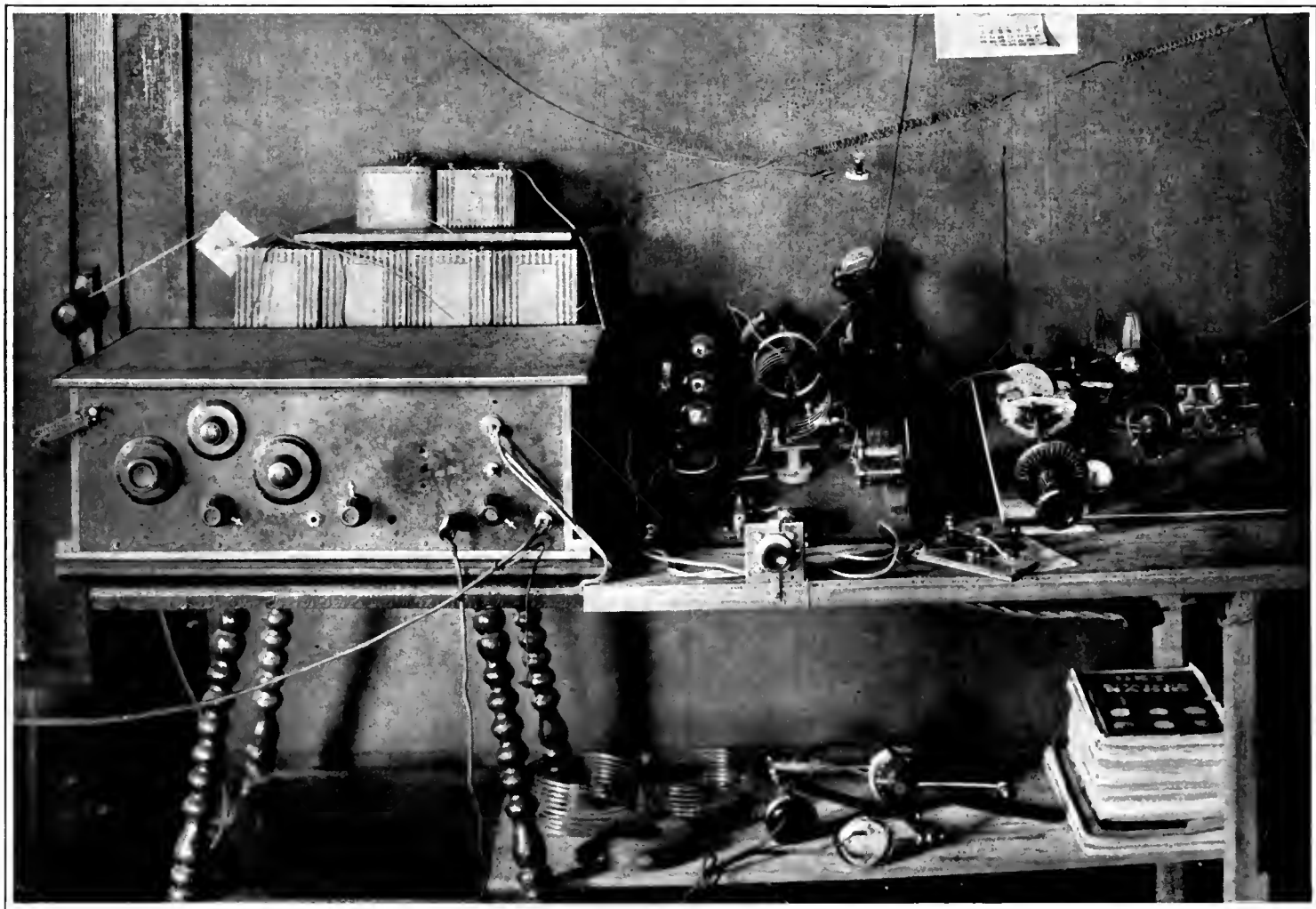

FIG. 4

A photograph of 9 ccq at Braymer, Missouri. The three 201-A tubes with their elements in parallel, the calibrated short wave receiver, and the compendium of amateur information—QST—are worthy of notice. We suspect the big box at the left is a broadcast receiver

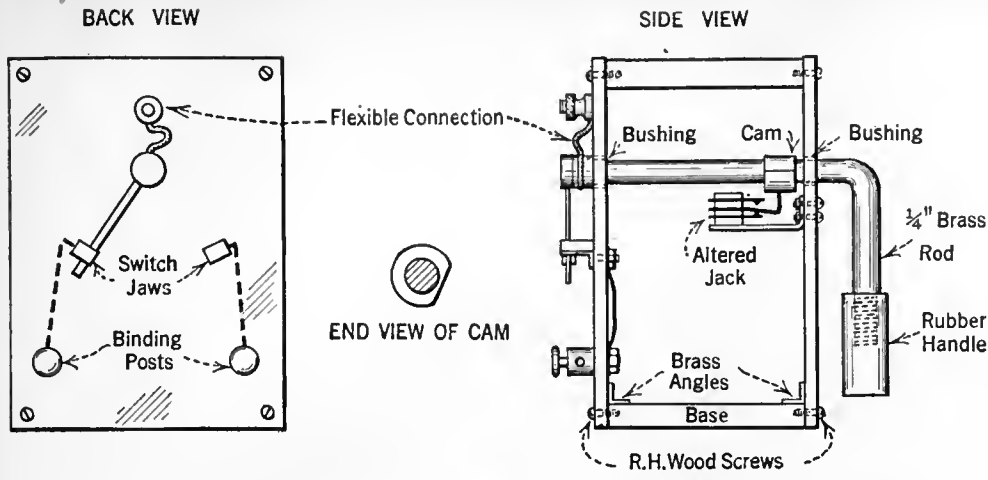
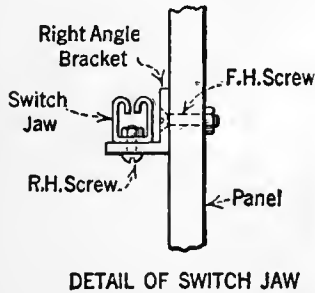

FIG. 6

Details of the throw-over switch which changes the antenna and batteries from sending to receiving



RADIO BROADCAST Photograph

TABLE OF AUDIBILITY SIGNS	
R1	Faint signals, just audible
R2	Weak signals, barely readable
R3	Weak signals, but readable
R4	Fair signals, easily readable
R5	Moderately strong signals
R6	Strong signals
R7	Good strong signals. Would be readable through heavy QRN and QRM
R8	Very strong signals. "Several feet-from-phones signals"
R9	Extremely strong signals

well insulated as possible, and an accompanying photograph shows some Pyrex insulators made by the Corning Glass Works which are now being installed at 2 GY.

Coupling to the antenna should be loose enough so that the tube continues to oscillate under all conditions. If coupling is too close, the wavelength will jump about and no listening operator can read what you are trying to send.

On 40 meters, reception is erratic, fading is bad, but phenomenal distances can be attained with low powers. On 80 meters transmitting distances are not so great, but steady signals, good traffic handling, and the possibility of phone transmission make it a very interesting band in which to work.

A few words about 9 CCQ may not be amiss to show that the work done between that station and 2 GY is not due to unusual conditions but rather to the great carrying power of transmissions on 40 meters with pure d. c. plate supply. Station 9 CCQ is operated by Mr. Vere Davis at Braymer, Missouri, about 1080 miles from Garden City. Braymer is 60 miles East of Kansas City and 20 miles southwest of Chillicothe in rolling country which is still blessed with considerable timber.

Mr. Davis says he "became interested in broadcast radio about three years ago and it's just a case of drifting from bad to worse, I guess. Have had an amateur's license now about four or five months and have been active about two and one-half. I became interested in amateur radio just about the same way most anybody of my age and interests does. I've always read radio magazines when I got the chance

and of course couldn't help seeing short wave circuits and the marvelous things they were supposed to do. I made my first successful short wave receiver last spring, a little less than a year ago, with the intention first of listening to the short wave broadcasts and was very disappointed when KDKA came in strong but with bad fad-

ing and distortion. So another fan, now 9 CJD, and I began practicing the code, and to our surprise passed the amateurs' examination. My first communication was with 9 WQ at Elmhurst, Illinois (40 meters), at about 4 o'clock p. m. November 1st. Next was 9 BV at Council Bluffs, Iowa, and the third was 8 CJM, Elyria, Ohio, but I found trouble raising stations. I could get a large current in the antenna but it wasn't effective. In a month or so I got time to improve the system and although I don't get the current I did, reports are better now. Have been reported at 5 AQI, Meridian, Mississippi, R 6 at about noon. Plate voltage 220, mils., 33."

Since the International Tests, this simple transmitter has been in operation at 2 GY with complete success, reports indicating that the pure d.c. note penetrates much better than our "high powered" outfit, for distances up to 1000 miles. The operators at 2 GY welcome reports of reception and will be glad to advise any of RADIO BROADCAST'S readers who are interested in low power, short wavelength amateur work.

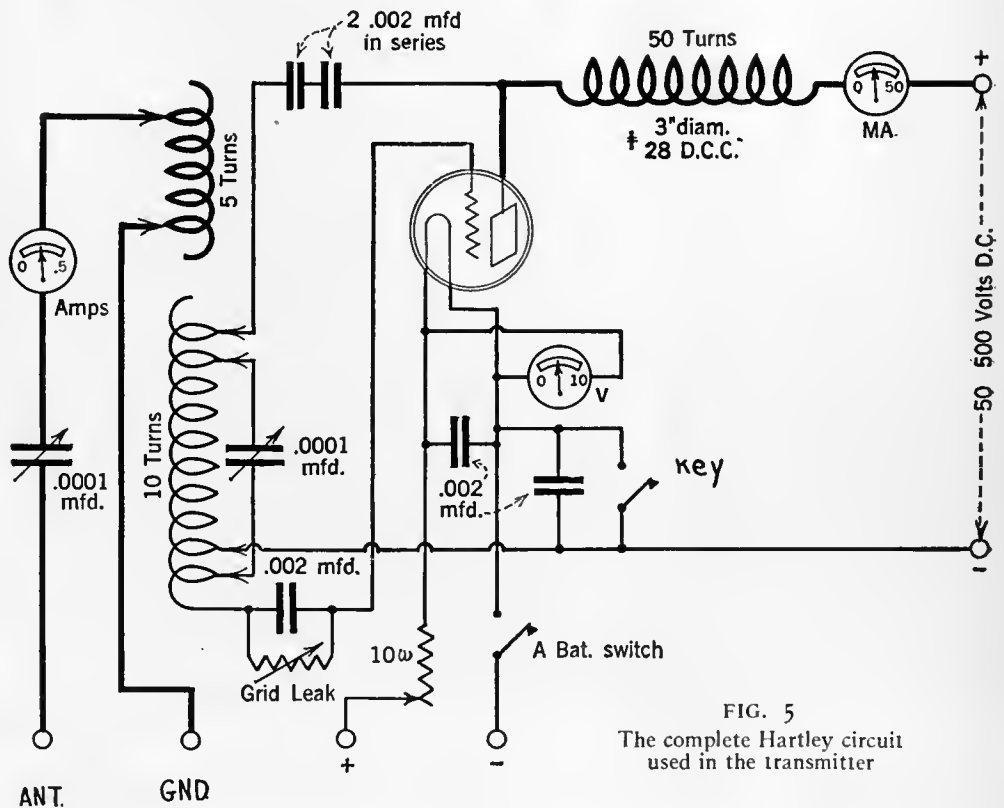
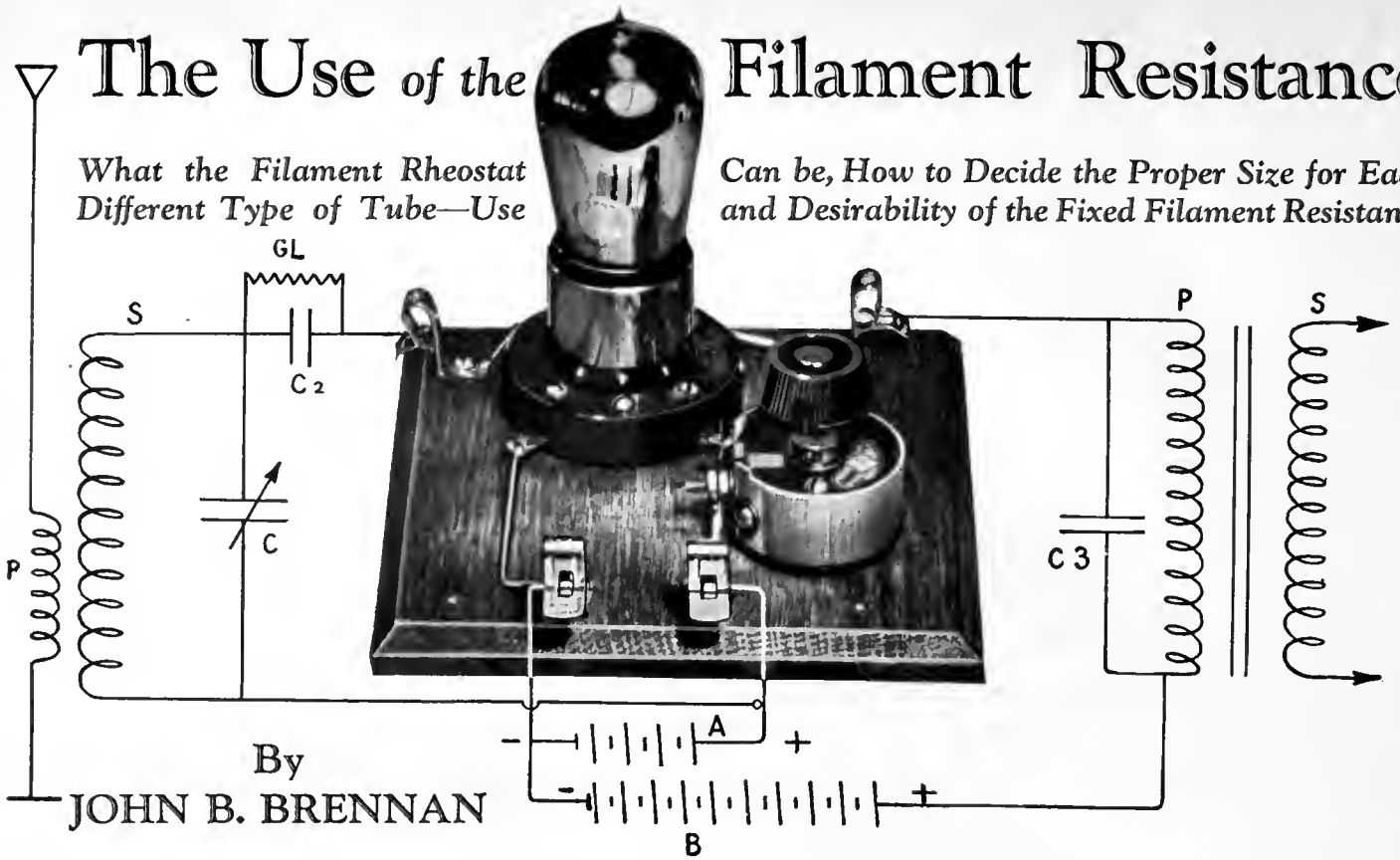

FIG. 5  
The complete Hartley circuit used in the transmitter

# The Use of the Filament Resistance

What the Filament Rheostat Different Type of Tube—Use

Can be, How to Decide the Proper Size for Each and Desirability of the Fixed Filament Resistance



**T**HE vacuum tube, that indispensable unit of the radio receiver, which transforms unintelligible radio signals into sounds that we can hear has been dealt with at length admirably by Keith Henney in the December, 1925, and February, 1926, issues of RADIO BROADCAST. In these articles, Mr. Henney dwelt upon the selection, use, and function of the vacuum tube in radio circuits and described in detail the parts played by the three elements of the tube, the plate, grid, and filament.

It is the last named, which is taken as the subject for this article. We shall try to show how this filament performs its task efficiently by the use of suitable control devices which adjust or regulate the current and voltage applied to it.

The filament is the thing that lights up when the A battery is applied to its terminals and emits electrons at a given rate. The grid is the regulator or shutter which stops or lets flow the electronic stream to the plate, the third element. In this way, feeble radio impulses impressed on the grid release a stronger impulse in the plate and its attendant circuits.

Manufacturers of the early tubes found it necessary to employ a control in the filament circuit of the tube so that the tube might be adjusted to its most efficient point of operation. Naturally they could not use a six-volt filament energized by a six-volt battery because the regulation so necessary would not be obtained. The five-volt filament, energized by the six volt storage battery, allowed for an adjustment

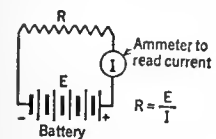

through the circuit. This arrangement is comparable to a tube circuit where the resistance R is represented by the tube filament and the external control device

FIG. 1

A simple circuit comprising a source of voltage (battery) a resistance (R) and a means for reading the current flowing through the circuit. This arrangement is comparable to a tube circuit where the resistance R is represented by the tube filament and the external control device

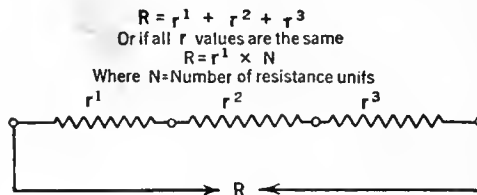

FIG. 3

Resistances in series retard to a greater extent the flow of current in a circuit than where only one resistance unit is used. The total resistance of a series-resistance circuit is equal to the sum of all the resistances employed. In a circuit of this kind it is possible to employ two 3-volt tubes energized from a 6-volt source

presumably from zero to six volts by means of a variable resistance. Soft tubes, as they were known not so long ago, required critical filament adjustment and to obtain this end, a rheostat had to be used. Sometimes the best operating voltage was found to be five but most times not. Each tube had its own peculiarities.

Now, the manufacturers have advanced the design and manufacture of the tubes to such a point that the filament adjustment is not critical.

Keith Henney has pointed out in RADIO BROADCAST that with the present tubes, a decrease in filament voltage below five is usually accompanied by a falling off in signal tone quality. Also, a slight increase above the rated filament voltage always causes a surprising decrease in filament life. To prevent this it is obvious that the old six-volt storage battery, borrowed from the automobile days, must still be retained so that a regulation of one volt in the rheostat may be had to maintain the filament at five volts.

When the battery is newly charged, more resistance of the rheostat will be in the circuit to maintain it at five volts. However, when the battery voltage drops off then this resistance is cut out of the circuit to compensate for the drop

in voltage at the battery terminals. Theoretically this is true but in actual practise, the battery maintains its full charge over the major portion of a single charge life. Toward the end it does drop in voltage but its energy has been expended to the point where the rheostat is useful, in maintaining the tube voltage at 5 only for a few hours. Then the battery may be considered in need of recharging.

Some tubes require 1.1 volts, others 3 volts and still others 5 volts. Therefore, it is essential that we adjust each of these filaments economically and efficiently. To make this clearer, it would not be strict economy or efficiency to control a 1.1-volt tube filament with a 60-ohm rheostat where only 1.6 ohms are required, only unless the battery voltage was much higher than  $1\frac{1}{2}$ . Even this is an unusual case.

## SELECTING THE PROPER RESISTANCE

**F**OR the radio set constructor then, there arises a problem in selecting the proper size of rheostat for the tube or tubes he is going to use. To understand what is happening in a circuit where voltage, resistance, and current are present, it is necessary to review the law governing the use and application of resistances in a circuit. Ohm's Law says that where a pressure of one volt is exerted in a circuit whose resistance is one ohm, then one ampere of current will flow. Now if the resistance is reduced to one half, the voltage

FIG. 2

When several resistances, such as tube filaments are connected in parallel as is the case in the majority of receivers, the total resistance of the circuit offered to the flow of current is less than were only one resistance unit used in the circuit because several paths are provided for the flow of current

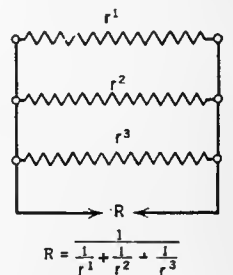

$$R = \frac{1}{\frac{1}{r^1} + \frac{1}{r^2} + \frac{1}{r^3}}$$

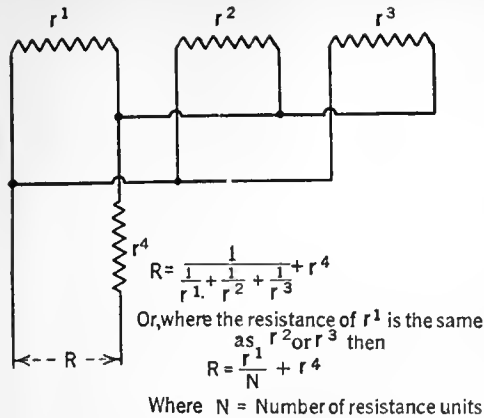

FIG. 4

A series-parallel circuit. The total resistance of the circuit is determined by first calculating the parallel circuit resistance of  $r^1$ ,  $r^2$ , and  $r^3$  and adding that total to  $r^4$

remaining constant, then double the current will flow. This gives rise to the equation  $I = \frac{E}{R}$  where  $I$  is the current in amperes,  $E$  is the pressure in volts and  $R$  the resistance in ohms. From this equation it is possible by transposing, to find any one value where the other two are known. That is to say  $E = I \times R$  and  $R = \frac{E}{I}$ . A circuit comprising these three factors is shown in Fig. 1.

If a resistance is paralleled by another of the same value, then two paths are provided for the flow of current so the total resistance to this flow is cut in half. If the resistances are added to each other, that is, connected in series, then the current flow is retarded because the total circuit resistance has been increased. To determine the total resistance of a circuit where resistances are in parallel the formula  $R =$

$$\frac{1}{\frac{1}{R_1} + \frac{1}{R_2} + \frac{1}{R_3}}$$

Where the resistances are in series, the total resistance is equal to the sum of all the resistances or where the resistance per unit is the same, then the total is equal to the value of one unit multiplied by the number of units employed. Expressed algebraically  $R = r_1 + r_2 + r_3$ , etc. or  $R = r_1 \times N$  where  $R$  = total resistance  $r$  = resistance per unit and  $N$  = number of units. This is illustrated in Fig. 3.

It is possible to combine resistances in a circuit so that a series-parallel arrangement is produced. This is the case where it is desired to know the total resistance of a circuit comprising several tubes in parallel with a single rheostat in series with the tubes and battery. To calculate this total resistance, it is first necessary to find the resistance of all the tubes in parallel. Then when this value is known it is added to the value of the resistance of the rheostat. This is illustrated in Fig. 4.

In the matter of determining the resistance of the tube filament Ohm's Law is employed first and then where it is desired to know the total resistance of a circuit, where such an arrangement exists as in Fig. 4 then the formula for resistances in series is employed.

Take, for example, a five-volt tube. Its filament should be energized by the battery so that .25 ampere of current flows in the circuit when the voltage at the tube terminals is 5. With these two known factors it is possible to determine the resistance of the circuit. Since the resistance of the battery and wire for the circuit is negligible, therefore the resistance computed will be purely tube resistance. Applying Ohm's Law  $R = \frac{E}{I}$  where  $R$  = resistance of

the tube,  $E$  = rated voltage of tube,  $I$  = rated filament current in amperes. Then  $R = \frac{5}{.25} = 20$  ohms.

WHY RESISTANCES ARE NEEDED

Now if six volts is applied to a filament, the current will be correspondingly greater than with five volts. In order to keep the current at that point stipulated by the tube manufacturer, it is necessary to decrease this voltage by adding resistance to the circuit.

Until a short while ago the one means for regulating the current flow and voltage in a filament circuit was by means of the rheostat but lately there has been placed on the market the filament ballast, otherwise termed filament regulator. That is, they automatically decrease the battery voltage to the correct point for application to the filament terminals.

It is a known fact that the battery voltage remains quite constant over the major portion of its discharge life but at the end takes a decided and sudden drop. A curve illustrating this is shown in Fig. 5. It is because of this voltage life-retaining property of the battery that filament ballasts have proved satisfactory for use as filament controls. For those who desire simplicity of control, the filament ballast will commend itself.

Writers of radio articles have differed widely for years concerning the correct value of rheostat to be used in a filament circuit. The best possible advice, and the easiest to follow is that our old friend Ohm's Law be used. Where two factors or values of this equation are known, the third can be determined by the application of the formula.

Let's look over a typical filament circuit consisting of tube, rheostat and battery, such as that in Fig. 6 B. The filament  $R$  of the tube is considered as a resistance and, therefore, its value may be rated in ohms. The battery  $E$  is the source of the energy which lights the filament and has a certain voltage, usually six. The rheostat  $r$ , has a variable external resistance whose total resistance we do not know, but wish to ascertain. If there were no rheostat  $r$ , in the circuit and the voltage of the battery were 5, then the total resistance of the circuit would be 20 ohms. If the battery voltage were raised to 6 then .3 amperes of current would flow in the circuit instead of the rated .25 amperes.

Now by introducing a resistance in the form of the rheostat  $r$ , not only is the current reduced but the voltage at the filament terminals is accordingly diminished. By applying the formula  $R = \frac{E}{I}$  then  $R = \frac{6}{.25} = 24$  ohms which is the total resistance of the circuit. How much

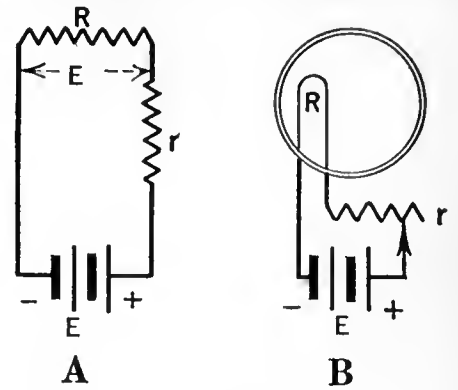

$$r = \left( \frac{E}{I} \right) - \left( \frac{E_1}{I} \right)$$

Where  $r$  = Rheostat resistance  
 $E$  = Battery voltage  
 $E_1$  = Filament terminal voltage  
 $I$  = Filament amperes

Example:

$$r = \left( \frac{6}{.25} \right) - \left( \frac{5}{.25} \right) = 4 \text{ Ohms}$$

FIG. 6

Determining the resistance value of the unit 'r' in the circuit above involves the use of the formula as shown. The battery voltage, the tube resistance and the current are usually known; from these values it is possible to calculate the unknown

resistance is necessary in the rheostat? The answer may be found by subtracting the circuit resistance at 5 volts from the circuit resistance at 6 volts i. e.  $24 - 20 = 4$  ohms as shown in Fig. 6A. From this we see that with 4 ohms in the circuit where a fully charged 6-volt storage battery is employed, .25 amperes of current will flow. Theoretically, as the charge in the battery decreases, the voltage decreases; therefore, to keep the circuit characteristics at their rated level, it is necessary to cut out part of the external resistance to compensate for the corresponding drop in battery voltage.

Now the main rub comes in the advocacy of rheostats larger than 4 ohms where only one tube is to be controlled by it. Of course, if one rheostat controls more than one tube, the proper resistance value may be calculated since usually the tube filaments are in parallel and as such the total resistance of these filaments is figured from

$$\frac{1}{\frac{1}{r_1} + \frac{1}{r_2} + \frac{1}{r_3}} \text{ etc.}$$

To use a rheostat of 4 ohms means that when the movable arm touches the first turn of the wire

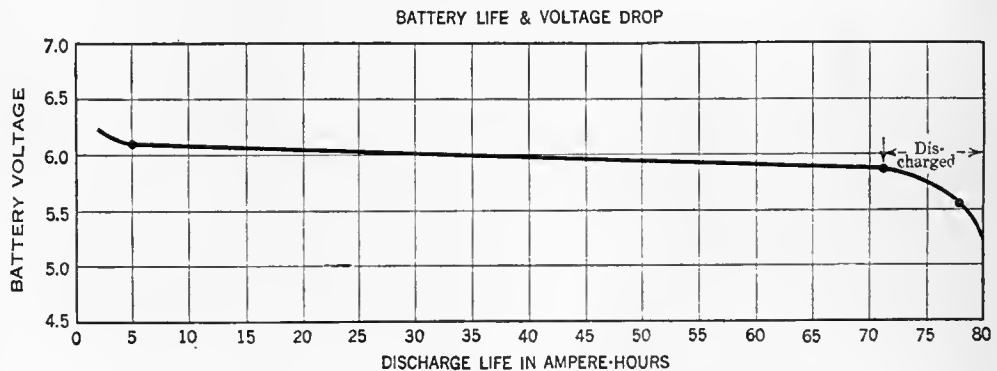

FIG. 5

When a fully charged battery is first used, its voltage is slightly above six volts. The major portion of its life, however, is at a fairly constant voltage level, the gradual drop being from 6 to 5.7 volts. When this low point has been reached, the battery is considered discharged and is in need of recharge. As the 5.7 point is reached the rheostat in a filament circuit is of greatest use because as the rheostat arm is advanced the voltage at the tube terminals is maintained at its highest point

Table I  
Various Types of Tubes and Their Respective Rheostats

UV-200		UX-112	
NUMBER OF TUBES IN PARALLEL	MAXIMUM RESISTANCE OF RHEOSTAT IN OHMS	NUMBER OF TUBES IN PARALLEL	MAXIMUM RESISTANCE OF RHEOSTAT IN OHMS
1	1.0	1	.5
		2	1.0
UV-201		TYPE 199	
1	1.0	1	25.0
2	.5	2	12.5
3	.33	3	8.33
4	.25	4	6.25
TYPE 201A		TYPE 120	
1	4.0	1	12.0
2	2.0	2	6.0
3	1.33		
4	1.0		
WD-12			
NUMBER OF TUBES IN PARALLEL	MAXIMUM RESISTANCE OF RHEOSTAT IN OHMS		
1	1.6		
2	.8		
3	.53		
4	.4		

on the rheostat, the required amount of resistance is immediately introduced in the circuit. Then as the battery voltage drops, off toward the end of its ampere hour capacity this arm can be advanced over the entire periphery of the rheostat surface to keep the filament voltage constant. Where a 20-ohm rheostat is employed, four-fifths of the rheostat is unused as only the last 4 ohms is required in the circuit. Then as the battery voltage drops, the regulation is over only one fifth the surface as compared to the entire surface of the 4-ohm rheostat.

Various diameters and textures of resistance wires have different current carrying properties. In the case just cited, assuming that the 4-ohm, and 20-ohm rheostats are of the same physical dimensions, then the space in which the resistance unit is placed is the same for each. Now if on one, there is to be wound resistance wire totaling 20 ohms, while on the other there is to be only 4 ohms, then the both must be wound with such a diameter of wire as will fill up the whole space. The 20-ohm rheostat will be

wound with thinner wire so that the full 20 ohms are accommodated on the same size form. The thinner wire is used because per inch it has more resistance than that used on the 4-ohm rheostat. Less current can be carried by small wires than by larger wires. So, by forcing too great a current through a small wire, heat is produced, and in its dissipation sometimes warps or otherwise injures the forms of the rheostat wound with small wire. This is especially true in the case of 20-ohm rheostats where it is intended to use only 4 ohms. This means that one-fifth of the entire wire is used where if a 4-, or 6-ohm rheostat were used in the first place, it would be safer because the wire would be larger, insuring ample current carrying capacity and also any desired variation in current would be finer since the change in resistance produced by a movement of the contact arm would be less per unit of change than if the same movement were made on the 20-ohm rheostat.

THE FILAMENT BALLAST

THE only point that may be raised in objection to the use of filament ballasts is that they do not permit of detector filament regulation or regeneration control as the rheostat does. However, now as ticklers, feedback condensers and variable plate circuit resistors are generally used for oscillation control, that objection is not serious. Examine the curve in Fig. 5, showing the voltage of a battery over a period of discharge hours. The battery practically maintains its voltage until very near the end of its charged life, then rapidly falls. The use of the rheostat or filament ballast is helpful only up to the point where the sudden drop occurs. When past this point the battery must be recharged and rheo-

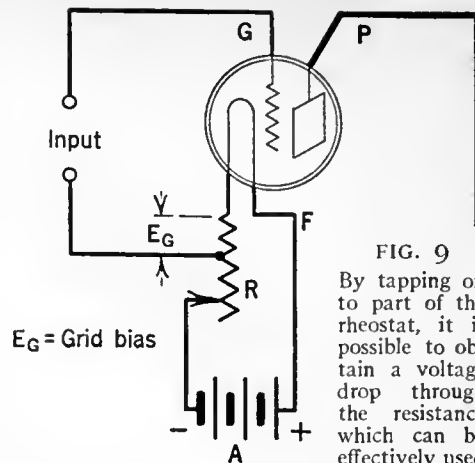

FIG. 9

By tapping on to part of the rheostat, it is possible to obtain a voltage drop through the resistance which can be effectively used

for biasing the grid of a tube with the same result as a C battery. However, this practice is not to be recommended as the difficulties of soldering and unsoldering the lead necessary to obtain the correct grid bias for a tube is great compared to the ease and simplicity of providing a C battery for this purpose

stats and filament ballast will not assist for long in maintaining the tube voltage at 5.

Look at the curve for a filament ballast in Fig. 7. From 6 volts, the charged state of the battery, to 5.7 volts when the battery is considered discharged, there is only a change of .006 amperes from the rated .25 amperes of filament current, surely not enough to be seriously considered as affecting the proper and efficient operation of the tube in a radio circuit.

In the case of dry cell tubes, there is not this constancy of voltage in dry cell batteries as compared with the storage battery unless many batteries are connected in parallel so, therefore, it is essential that a variable resistor be used to maintain the tube filament voltage at a constant level even though the battery does drop in voltage from 4.5 to 3 volts as is the case where 199 type tubes are employed. When the battery voltage falls below 3 then tone quality will probably suffer and it is wise to replace with new batteries.

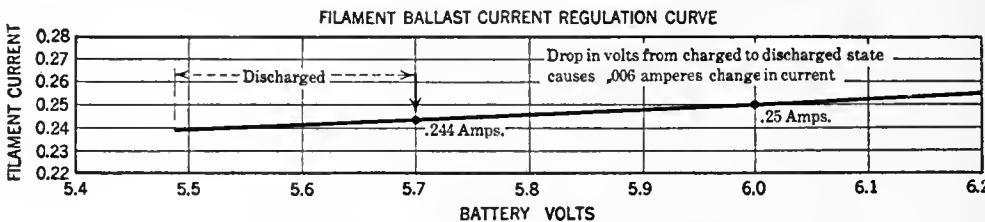

FIG. 7

Filament ballasts are used to regulate the flow of current in a tube circuit. Their purpose is to maintain this current value at a constant point as the battery becomes discharged. From the above it will be seen how successfully this purpose is accomplished. As the battery fell off in voltage, the filament ballast caused a change in the current in the tube circuit from .25 amperes to .244 amperes—.006 amperes, not enough to be seriously considered as affecting the proper operation of the tube at its rated filament characteristic

FIG. 8

Four types of filament ballasts that were tested are shown here. From left to right they are the Elkay manufactured by the Langbien Kaufman Radio Co., the Brach-stat (L. S. Brach Mfg. Co.), the Amperite (Radiall Co.), and the Daven ballast, (Daven Radio Corporation.) Several instruments used in the collection and calculation of figures presented in this article are also shown



RADIO BROADCAST Photograph

Table II  
Tube Operating Characteristics

TYPE OF TUBE	FILAMENT CURRENT IN AMPERES	FILAMENT VOLTS	BATTERY VOLTS	FILAMENT RESISTANCE
201A	.25	5	6.	20
199	.06	3	4.5	50
120	.125	3	4.5	24
112	.5	5	6.	10
12	.25	1.1	1.5	4.4
UV-200	1.0	5	6	5
UV-201	1.0	5	6	5

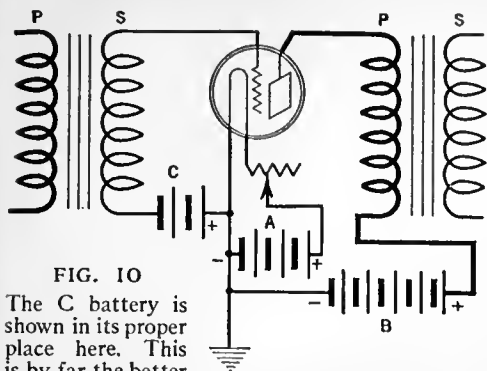

FIG. 10

The C battery is shown in its proper place here. This is by far the better way to obtain grid bias for receiving tubes since if it is desired to vary the grid bias voltage, more or less C battery may be placed in the circuit

Rheostats are variable resistances with which an accurate control of the filament voltage and current is obtained. The selection of a rheostat for one tube has already been explained and the radio experimenter should not become confused where more than one tube is controlled by a single rheostat. As it has been said, in a radio circuit it is usual to connect several tubes in parallel, the path for the flow of current will become greater hence there will be less resistance to the flow of this current. In tube circuits it is customary to employ tubes all of one nature, that is, all 5- or all 3-volt tubes. The total resistance then, of a circuit, is equal to the resistance of one tube divided by the number of tubes in the parallel arrangement. See Fig. 4. For instance, 201-A's have a resistance of 20 ohms. Where four are connected in parallel the total circuit resistance is 5 ohms. Therefore, to cut down the battery voltage so that five volts are applied to the filament terminals, 1 ohm of external resistance must be added to the circuit. Before, the method by which the rheostat value was ascertained was to subtract the circuit resistance at 5 volts from the circuit resistance at 6 volts. Another method, also very good, is to employ the formula  $R = \frac{E - E_r}{I}$  where R = resistance of rheostat,  $E_r$  = filament voltage, E = battery voltage and I = total current of circuit. This last factor, total current, is obtained by multiplying the current rate of one tube by the number of tubes to be controlled by the rheostat. Again, using four tubes, the total current would be  $4 \times .25$  amperes = 1 ampere. Then, applying the formula  $R = \frac{6 - 5}{1} = 1$  ohm.

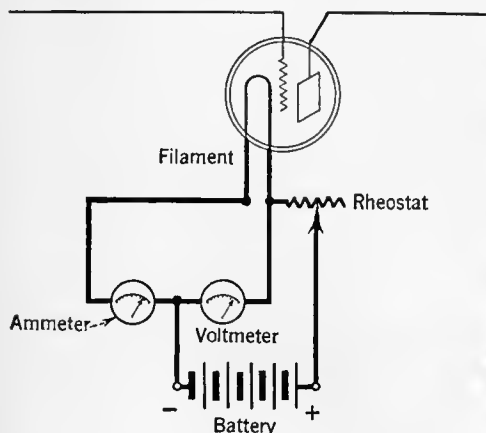

FIG. 11

Voltmeters and ammeters indicate the amount of voltage and current in a circuit. This is the circuit of the test set actually employed in checking the regulation properties of rheostats and filament ballasts described in this article

WHERE SHOULD THE RESISTANCE GO?

INDEPENDENT tube manufacturers as well as the pioneers in tube production advocate the use of the rheostat in the negative side of the A battery lead. The writer became convinced that this procedure was proper only where the rheostat was to be employed to provide a grid bias of a few volts. This usually was supplied by tapping on to a portion of the rheostat so that a voltage drop through that portion of the resistance employed would provide the necessary few volts for grid biasing.

In Fig. 9 the circuit shows how this tap is arranged. This manner of obtaining grid bias is unusual inasmuch as it entails first, a calculation as to the necessary amount of resistance wire to be included in the tap-off circuit so as to supply the necessary grid voltage. Secondly, it is sometimes desirable to vary the grid bias and when the connection is soldered to the rheostat a change in voltage is impossible unless the tap-off be unsoldered.

The use of a C battery provides the more convenient and simpler way to obtain grid bias and with this change it is possible to place the rheostat in the positive side of the A supply lead so that all the negative leads are at ground potential as in Fig. 9. The use of the rheostat in the positive side instead of the negative side of the A battery supply makes for more accurate wiring, clearer understanding of circuit diagrams, and the surety that one part of the complete wiring circuit will be at ground potential insuring shorter leads from other units in the circuit which of necessity must be connected to the ground line.

Among the rheostats tested because of the difference in design and principle was the Bradleystat, and the Filkostat. Both these devices insure a continuous, even increase in voltage differing from the wire-wound rheostat which provided the increase in steps as more turns of wire was cut out of the circuit. Voltage regulation is secured by the change in resistance of the device as carbon discs are compressed by means of a thumb screw.

Table III  
Filament Ballasts for Various Tubes

TUBE	ELKAY EQUALIZOR	RADIALL AMPERITE	DAVEN BALLAST	BRACH BRACHSTAT
1 type 199	No. 50 for 6 volt source	No. 6V 199 for 6 volt source No. 4 V 199 for 4 or 4.5 volt source		1 C for 4 volt source 1 D for 6 volt source
2 type 199's	No. 25	No. 120		2 C
1 type 120	No. 25	No. 120		2 C
1 type 201-A	No. 4	No. 1-A	No. 1	1 B
2 type 201-A's	No. 2	No. 112	No. 2	2 B
1 type 112	No. 2	No. 112	Use No. 3 for 3 type-201 A's and No. 4 for 4 type 201A's	
MU 20	No. O			
MU 6	No. O			
WD 11				
WD 12				
WX 12				
C 11		D 11		1 A
C 12				
CX 12				

If you intend to build a super-heterodyne and control eight tubes with one rheostat then that rheostat should be of the power variety capable of carrying from 2 to 3 amperes of current. This is especially necessary where the new power tubes are to be employed in the audio end since they take more current than the ordinary 201-A type of tube. Fortunately, filament ballast makers have kept up with the development of the power tubes and today it is possible to purchase special ballasts designed solely for use with these new tubes.

The total watts consumed in a filament is 1.5, of this, .25 watts is dissipated in the rheostat or other filament resistance. This means that there is a 16 2/3 per cent. loss of power in the filament resistor and only 83 1/3 per cent. of the power being utilized in the filament directly.

Outstanding are these several not-to-be ignored facts:

A 4-ohm rheostat is satisfactory for controlling a single 201A.

A variable resistance may be used for detector filament regulation but for other tubes fixed resistances are satisfactory.

Filament ballasts may be used successfully in all tube filament circuits except detectors.

Dry cell tubes need variable filament control.

Where grid biasing is desired, use a C battery.

Tone quality suffers when the filament or plate voltage is reduced.



FIG. 12

Only a few of the many rheostats that were tested are shown here. The Kellogg type of resistance unit has its circular form, with the resistance wire thereon as the rotating unit. The same is true of the Cutler-Hammer rheostat. Two carbon-pile type of resistance units are represented in the Filkostat and Bradleystat

# Cutting Out the Locals

Simple and Efficient Wave Traps to Eliminate Interfering Near-by Stations

By HOWARD E. RHODES

THE trend in broadcasting for some time has been toward the use of higher powers, wherever that is possible, and this, combined with the concentration of many stations in large centers, has made the problem of selectivity a serious one for many listeners. It is easy to remedy most of the trouble encountered in the average receiver by simply adding a wave trap of good design, and the accompanying article reviews the subject in a very helpful fashion. The present article is concerned with types which can be made very easily, and a second article, to be printed soon, will describe a radio-frequency amplifier and detail how it functions as a wave trap.—THE EDITOR.

WITH the increase in power of a great many of our broadcasting stations, listeners find need of some efficient method whereby undesired signals may be eliminated. These signals sometimes are caused by direct pick-up by the coils of the set so that its natural selectivity is of no avail in eliminating them. This occurs when the set is being operated in proximity to a broadcasting station with the result that the field strength in the vicinity is great enough to induce currents directly in the various coils of the receiver. Under these conditions it will be found possible to hear the program with the antenna disconnected.

The only practical methods to be used in eliminating this type of interference are either shielding of the receiver or using some form of close field coil, such as a toroid. If the set is to be shielded, it is necessary to line the entire

inside of the cabinet, including the cover and the panel, with thin copper. Any joints in the copper sheet are soldered together and connection is finally made between the shield and the minus A terminal which should, in this case, be connected to ground. This puts the entire shield at ground potential, thereby excluding from the coils any external electrical fields. It should also be pointed out that this shielding will also eliminate any interference caused by power lines, motors, etc., provided they are causing trouble by setting up currents directly in the coils. However, if this interference is reaching

curve of Fig. 10 which represents the resonance curves of a fairly good receiver. For ordinary reception this degree of selectivity is satisfactory, but under some unusual condition, even greater selectivity might be required. For instance, the receiver might be operated at a location quite close to a powerful broadcasting station so that the signal strength from this station, in comparison with the strength of the signals that it is desired to receive, is so great as to produce considerable interference, even though the receiver is considerably detuned from the interfering signal. It is apparent then that in some way this powerful signal must be impeded so as to decrease its strength.

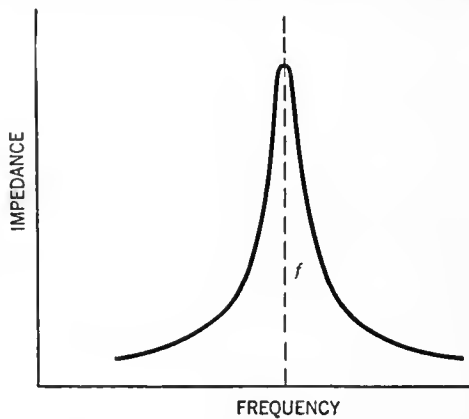

FIG. 1

The impedance curve of a well-made wave trap

the set by way of the antenna system, shielding will be of no aid.

A second and rather recently developed method of eliminating this type of interference is by the use of toroid coils. This type of coil is now being widely employed in instances where there is need of an inductor that is unaffected by external fields. The reason why toroids are not sensible to magnetic fields is easy to understand. Suppose such a coil is placed in a magnetic field. Then a voltage is induced in practically every turn of the coil. However, the voltage induced in one half of the coil is exactly equal and opposite to the voltage produced in the other half of the coil. These two voltages react against each other and the resultant effective voltage is therefore zero. This type of winding can be placed in comparatively strong magnetic fields without having any appreciable voltage produced in it. Toroids are, therefore, very useful in eliminating that type of interference caused by some form of direct pick-up by the coil units of a receiver. These two methods which have just been outlined, first, shielding of the set, and secondly, using Toroid coils, are practically the only methods of eliminating this type of interference.

There is a second type of interfering signal that also causes considerable trouble, and against this type the two methods so far described are useless. If the signals being induced in the antenna are sufficiently strong, it is possible that a receiver may not have a selectivity sharp enough to eliminate them completely, although its selectivity under ordinary conditions may be perfectly satisfactory. Take, for example, the

## THE SIMPLICITY OF A WAVE TRAP

THE most common piece of apparatus for use in this connection is the so-called wave trap which is actually a filter circuit tuned to absorb the interfering signals. These wave traps are very easily constructed, and cost little. They consist merely of an ordinary coil and a condenser. The traps are connected in the antenna circuit and are adjusted so that at the frequency of the interfering signal they have a very high impedance, the exact value depending on whether the unit is connected in series or parallel with the antenna. This high impedance prevents the signal from passing down through the primary of the antenna coupling and so into

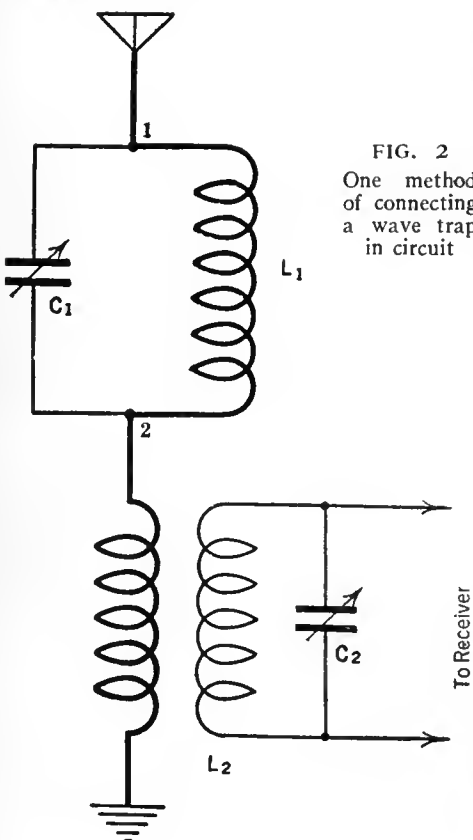

FIG. 2  
One method of connecting a wave trap in circuit

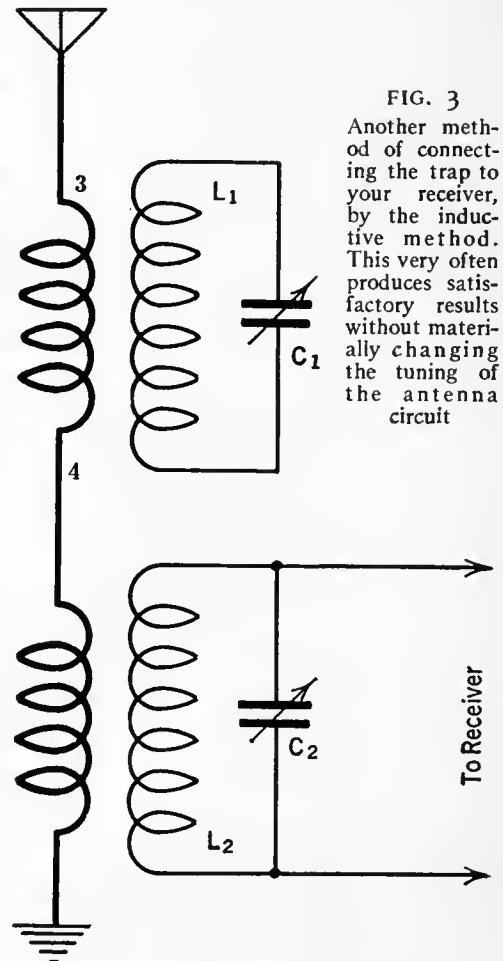

FIG. 3  
Another method of connecting the trap to your receiver, by the inductive method. This very often produces satisfactory results without materially changing the tuning of the antenna circuit



the receiver. At the same time, these wave traps offer a very low impedance to all other frequencies. In Fig. 1 there has been plotted the change in impedance of a wave trap as the frequency is varied, and this gives a good idea how a wave trap functions. At the frequency marked  $f$  on the diagram, the impedance as read on the ordinate of the curve is very high and since this circuit would be connected in the antenna system of a receiver, it is evident that at this frequency the impedance of the antenna system to this particular frequency would be very high, and for that reason practically no energy could be received at this frequency. At the same time, the impedance of the trap to any other fre-

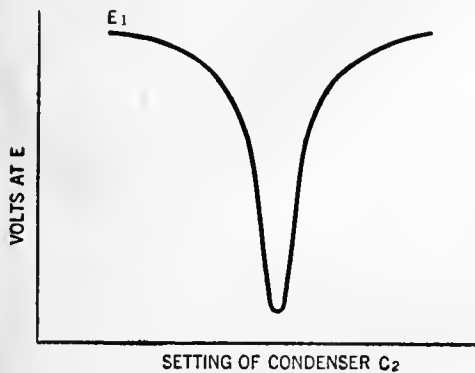

FIG. 5

A curve showing the decrease in interference obtained by the use of a wave trap

quencies, either above or below the frequency  $f$ , is very low. The efficiency with which the trap operates depends upon the steepness of the sides of the curve, and in order to obtain satisfactory operation, it is essential that a sharp resonance curve be obtained.

This idea of high impedance at resonance may

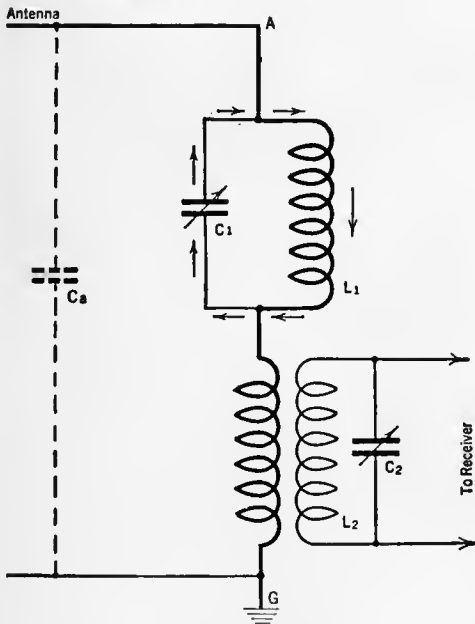

FIG. 6

The small arrows indicate the circulating current set up in the wave trap by the interfering signal

require some explanation since we are accustomed to think of resonant circuits as having a low impedance. At resonance, a circuit consisting of a coil and a condenser has a low impedance to the flow of current around the path

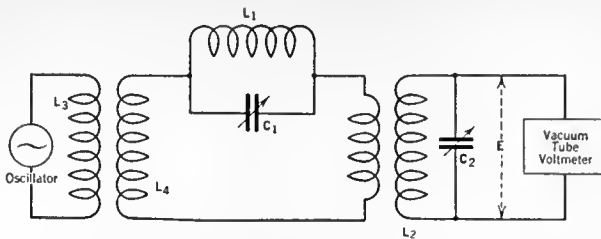

FIG. 4

The circuit diagram of the test apparatus used to obtain some of the data given in this article

indicated in Fig. 6, by the small arrows. This is important current with regard to the various tuned circuits of a receiver. In a wave trap, however, we wish to impede the flow of current in the circuit AGCa, and at resonance, the trap circuit offers high impedance to the flow of current in this circuit.

There are several methods of connecting these traps. Fig. 2 shows the most common method. In this drawing  $L_1 C_1$  constitutes the trap circuit, and  $L_2 C_2$  the antenna coupler and tuning condenser of the receiving set. It is seen that the trap is connected between the antenna post of the receiver and the antenna lead-in. Fig. 3 represents a slightly different method of connecting the trap in the circuit. In this latter method, the wave trap is inductively coupled to the antenna. This inductive coupling is obtained by winding a few turns of wire about one end of the coil  $L_1$ . One end of this new winding connects to the antenna and the other to the antenna post of the receiver. This circuit is practically equivalent to that of Fig. 2 with the difference that somewhat sharper tuning is obtained.

WHY THE CIRCUIT PREVENTS INTERFERENCE

IN ORDER to give an idea of the effectiveness of these traps, a series of experiments were carried out in the RADIO BROADCAST Laboratory to illustrate how interfering signals are eliminated by the use of such a filter. The circuit illustrated in Fig. 4 was excited by means of an oscillator. The output of the oscillator was fed into the coil  $L_3$  which was inductively coupled to coil  $L_4$ . This coupling was very loose so that variation in the test circuit caused no change in the oscillator output.  $L_1 C_1$  is the trap circuit and  $L_2 C_2$  represents the input circuit of the receiver. As shown in the diagram, a vacuum tube voltmeter was placed across the  $L_2 C_2$  circuit so as to measure the voltage induced across this circuit. This would be the voltage that would ordinarily be applied to the grid of the first tube of a receiving set and the extent to which this voltage is reduced by the wave trap is a measure of the trap's efficiency.

With the trap circuit  $L_1 C_1$  detuned from the incoming frequency produced by the oscillator, the condenser  $C_2$  was adjusted until maximum voltage was read on the vacuum tube voltmeter. This indicated that this circuit was adjusted to resonance. The frequency of the oscillator was then changed by 10,000 cycles but no change was made in  $L_2 C_2$ .

This circuit was, therefore, tuned to a wave 10,000 cycles (10 kc.) different in frequency from that being supplied by the oscillator. However, a certain amount of voltage was still to be measured on the vacuum tube voltmeter

but since the circuit was not tuned to the oscillator frequency, the voltage which was measurable represented an interfering signal. This voltage read on the vacuum tube voltmeter under these conditions is represented as  $E_1$  in Fig. 5. The trap was then adjusted and as condenser  $C_1$  was varied, the voltage across  $L_2 C_2$  was recorded and a curve Fig. 5, plotted, showing the variation of voltage as the trap condenser  $C_1$  was changed. This curve shows a large decrease in voltage as the trap circuit is brought into resonance with the incoming frequency. With the trap in resonance the voltage decreased to about 15 per cent. of its former value.

This whole test was analogous to the case of a



RADIO BROADCAST Photograph

FIG. 7

Space-wound solenoid coils can be used to construct a very efficient wave trap

receiver tuned to a particular station and at the same time receiving a certain amount of energy from another station differing in frequency by 10 kilocycles (10,000 cycles). Under such conditions, the use of a trap would have caused a decrease of about 85 per cent. in the strength of the interfering signal. Let us take a numeri-

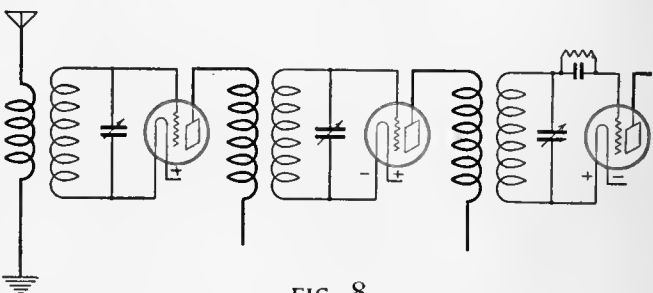

FIG. 8

A simplified diagram of a receiver employing three stages of radio frequency amplification, really successive wave traps

cal example of such a case. Suppose it is desired to receive a signal having a frequency of 500 kilocycles and to eliminate the interference from another station operating on 510 kilocycles. The antenna circuit of the receiver would be

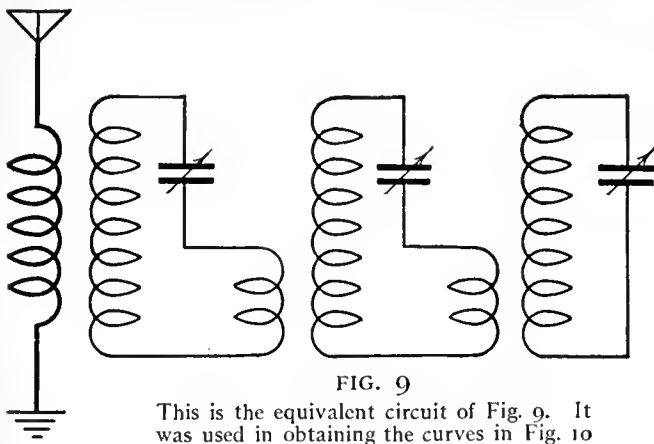

FIG. 9 This is the equivalent circuit of Fig. 9. It was used in obtaining the curves in Fig. 10

tuned to 500 kilocycles and then the wave trap would be tuned to 510 kilocycles with the result that the interfering signal of 510 kilocycles would be decreased to 85 per cent. of the value it would be without the trap. Under some conditions, it will be found that the type of connection used

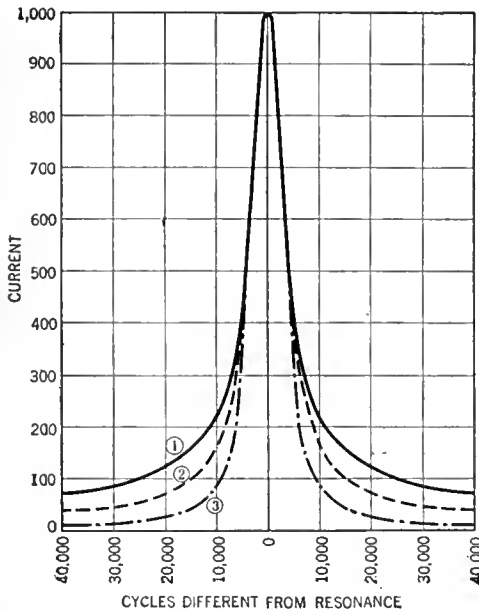

FIG. 10

Here's a curve that shows the effect of using several stages of tuned radio frequency

in the test suppresses too much of the main signal and it will be best to change over to the hook-up shown in Fig. 3. With the trap inductively coupled to the antenna circuit, the tuning is usually very much sharper but at the same time it is generally found that the interference is not as completely suppressed. Since the operating characteristics of the trap depend to some extent on the conditions at which the receiver is being operated, it is best to try both types of connection and determine which method gives the most satisfactory results. Sometimes the frequency separation between the signals it is desired to receive and the signals it is desired to suppress is very much greater than 10 kilocycles, and under such conditions the trap will operate even more efficiently.

WHICH CONNECTION TO USE

WHETHER the trap circuit of Fig. 2 or that of Fig. 3 is used depends to a considerable extent upon the characteristics of the antenna system. A well insulated antenna with a short lead-in and a short ground wire to a good ground, such as the cold water mains, gives

best results with the inductively coupled circuit. Every effort should be made to have as good a ground and antenna as possible, but if it is necessary to use a long ground lead to a rather poor ground system, the direct coupled wave trap will probably give most satisfactory operation.

When using the latter method of direct coupling as illustrated in Fig. 2, some small change in the tuning of the antenna condenser will be noticed whereas

with inductive coupling practically no change in tuning takes place. This represents a slight advantage in favor of inductive coupling, since it will be possible to continue to use the same old dial readings after the trap has been installed.

In designing a trap circuit, the difficulty arises in making one that will do its work well when the frequency separation is only 10 kilocycles.

If the trap is poorly made it may eliminate the interfering signals but will also decrease the strength of those signals we desire to receive. The most common cause of poor results with wave traps is due to the use of high resistance coils and low grade condensers.

It is therefore essential that the trap operate efficiently, and in order to obtain such operation, it is generally best to use a fairly small coil and a large condenser. With a large coil the elimination is usually more complete but the neutralized band is larger so that the trap interferes with reception on wavelengths adjacent to that wave on which the interfering station is operating. Most satisfactory results are obtained when low loss coils are used.

Any type of multiple-stage tuned radio frequency receiver is actually a series of traps or filters coupled together. The circuit shown in Fig. 8 is really equivalent to the circuit of Fig. 9. The tubes function as amplifiers and do not alter the resonance curves to any considerable extent. Fig. 10 shows a set of resonance curves obtained from a circuit connected as in Fig. 9. In a one-stage r. f. amplifier a resonance curve like 1 would be obtained. Adding two and then three stages give us curves 2 and 3 respectively.

In order to obtain maximum benefit from such an r. f. amplifier, it is essential that the various tuning units be constructed as efficiently as possible and if this is done it will not be necessary, under ordinary circumstances, to use a wave trap in conjunction with this type of receiver. Nevertheless, under some conditions, for instance when a set is being operated very close to a broadcasting station, the currents induced in the antenna might be strong enough to override the selectivity of such a receiver, and it will be necessary to use a wave trap.

In order to aid the home constructor in building up his own wave traps, the accompanying table has been compiled.

For those wishing to duplicate the model constructed in the Laboratory, the following material should be secured: one 36-turn Hammarlund Roberts 3-inch coil, one Cardwell .001-mfd.

TYPE OF COIL	SIZE WIRE	NO. OF TURNS	DIAMETER OF COIL	NO. OF PEGS
Spiderweb	20	40	2 1/4"	13
Diamondweave	20	30	2"	17
Solenoid	20	28	3 1/2"	—

variable condenser, one 3-inch dial, one panel 7 x 8 inches, and necessary binding posts, screws, etc. The apparatus layout is shown in Fig. 11. It is obvious that similar capacities and inductances, of any make, or home made, will be just as satisfactory.

The antenna winding consists of 10 turns of No. 20 wire wound directly over the Hammarlund Roberts coil and fastened with a small amount of collodion. If the trap is to be connected as in Fig. 2, the antenna goes to binding post No. 1 and the antenna terminal of the receiver to terminal No. 2 on the wave trap. For inductive coupling as in Fig. 3, the antenna connects to No. 3 and terminal No. 4 goes to the antenna binding post on the receiver.

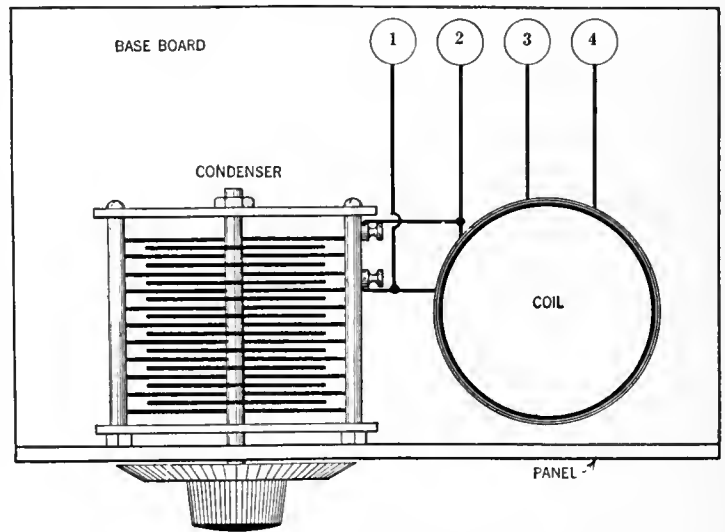

FIG. 11

The layout of apparatus for a wave trap. Note how simple the construction is

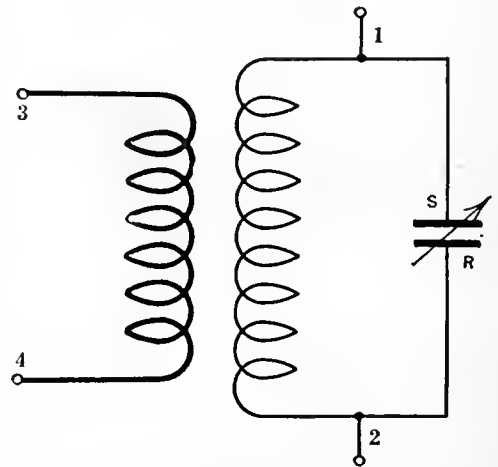
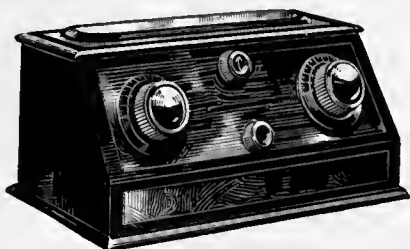

FIG. 12

Circuit diagram of the wave trap shown in Fig. 11. The notation on the binding posts in Fig. 12 correspond to the numbers on this diagram



**The Crosley 4-tube—4-29**  
*in which the Crescendon is equal to one or more additional tubes of tuned radio frequency amplification . . .* **\$29**



**The Crescendon**  
*—an amazing new volume control exclusive to Crosley sets. Hear it!*

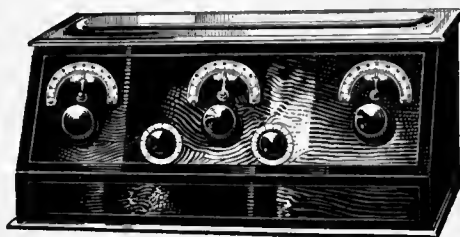

**The Crosley 5-tube—5-38**  
*All the volume, selectivity and purity of tone available in the best 5-tube set—plus the Crescendon . . .* **\$38**

## Widespread Popularity Marks Another Great Success

Spectacular as has been each stride in radio achieved by Powel Crosley, Jr., never before has a Crosley success received such prompt and widespread recognition. Here in the radio plant which has made more radios than any other factory in all the world, every man and machine is going at top speed, every hour is a crowded hour, every night a working day, as the result of orders for the four new Crosley sets.

Even the sweeping success of the Crosley Musicone did not match this merciless demand upon an organization tuned to mass production. With the first demonstrations by Crosley dealers, public approval was expressed in orders that have increased in volume day by day and show no inclination to relax.

This popularity is distributed quite evenly between the four new 4- and 5-tube sets. Thousands who had formerly believed that

worth while reception was exclusive to high priced sets, have found in Crosley 4-29 and 5-38 all that they could ask of radio. The accurate selectivity and pure tone of these instruments would be enough. That magnificent volume achieved through the *Crescendon* is the final touch.

And in Crosley "RFL" types there is a revelation for all. For here true cascade amplification makes its first appearance. Here what was considered *impossible* in expert opinion has been achieved by amplification closely approaching theoretical maximum efficiency per tube!

What a joy to find, and in a low priced set, rare beauty, rich tone, volume subject only to your desire, and no howling at any pitch by any mishandling under any conditions.

Each instrument delights the ear, fires the enthusiasm of the lay technician, converts the staunchest skeptic to love of radio.

See the new Crosley receiving sets at your dealer's or write Dept. 20 for descriptive catalog

Crosley manufactures radio receiving sets which are licensed under Armstrong U. S. Patent No. 1,113,149, or under patent applications of Radio Frequency Laboratories, Inc.

**THE CROSLLEY RADIO CORPORATION, CINCINNATI, OHIO**  
 Powel Crosley, Jr., President

Owning and Operating WLW, first remote control super-power broadcasting station in America



**The Crosley 5-tube—RFL-60**  
*A set of marvelous performance and beautified by the artistic decorative panel . . . . .* **\$60**

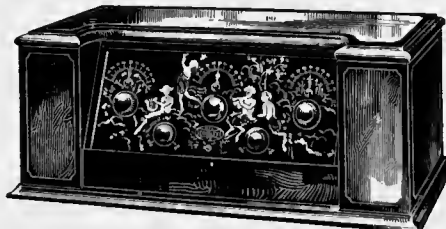

**The Crosley 5-tube—RFL-75**  
*Simplicity and speed in tuning, fidelity of tone and decorative beauty, enhanced by the art panel . . . . .* **\$75**

Add 10% to all prices west of the Rockies

# CROSLLEY RADIO

BETTER—COSTS LESS . . . . . FOR THE ENTERTAINMENT CORNER

# and now more stations come in distinctly

## A UX Power Tube

will increase the clarity and volume of YOUR set

### REWIRING UNNECESSARY

**NOTE:** The UX-120 tube for dry battery sets and the UX-112 for storage battery sets reproduce more perfectly the excellent broadcasting of to-day. These tubes handle the powerful signals of nearby stations so that the quality of the tone is preserved without distortion. You can easily obtain this increase in clarity without rewiring your set. A complete line of Na-Ald Adapters and Connectoralds have been made to meet this purpose. Their scientific design insures a nicety of operation. Below are given three efficient and easily made applications of the new power tubes. For complete details covering these and other applications of the new tube mail the coupon below.



No. 920 Connectorald

#### How to improve storage battery sets

Clarity and volume can be increased in storage battery sets by using the UX-112 tube in the last stage. Easily fitted to the UV-201A socket by means of the Na-Ald No. 112 Connectorald which also provides cables for attaching necessary extra B and C batteries. Price \$1.25. Mail coupon below for complete adapter information covering use of new tubes in all sets.

#### How to improve sets equipped with UV-199 tubes

To increase volume and clarity in sets using UV-199 tubes, use the UX-120 tube in the last stage. Easily fitted to the UV-199 socket with a Na-Ald No. 920 Connectorald which also provides cables for attaching necessary extra 45 volts B battery and 22½ volts C battery required for the UX tube. Price, \$1.25.

#### How to switch to dry batteries without sacrificing volume or quality

The combination of a UX-120 tube for the last stage with UX-199 tubes in the other sockets provides, with dry cells, results previously obtained only with storage batteries. Fit UX-120 tube to the UV-201A Socket with Na-Ald Connectorald No. 120. Cables provided for attaching extra B and C batteries. Fit UX-199 tubes in all other sockets with Na-Ald No. 419-X Adapters. Price, No. 120 Connectorald, \$1.25; No. 419-X Adapter, 35c.



No. 120 Connectorald

### ALDEN MANUFACTURING COMPANY

Dept. B 17 Springfield, Mass.  
All Na-Ald Sockets, Dials and Adapters are protected by patents. Many patents Pending



ALDEN MFG. CO., Dept. B17, Springfield, Mass.  
Please send me complete information on how to increase volume and clarity in any set by the use of the new tubes.

Name.....  
Address.....  
City..... State.....

# THE GRID

A Department Devoted to Solving the Problems of our Readers

## QUERIES ANSWERED

1. WHAT ARE THE DIMENSIONS AND NUMBER OF TURNS FOR THE COILS USED IN THE "UNIVERSAL" RECEIVER RECENTLY DESCRIBED IN RADIO BROADCAST?  
L. T.—Flushing, New York.
2. HOW MAY I ELIMINATE THE REFLEX PART OF THE ROBERTS CIRCUIT?  
G. C.—Altoona, Pennsylvania.

### "UNIVERSAL" RECEIVER COILS

THE coil units employed in the "Universal" receiver may very easily be made by winding on a 2¼ inch diameter cylindrical form, 59 turns of No. 24 d.s.c. wire in the manner shown in Fig. 1.

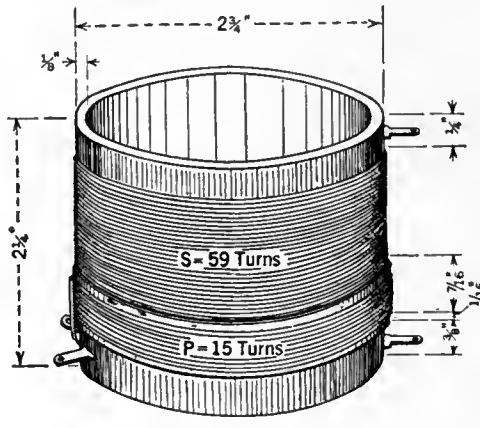

FIG. 1

The first winding put on the coil form is the secondary, and over it, at one end of the form, is wrapped a piece of insulating material, such as

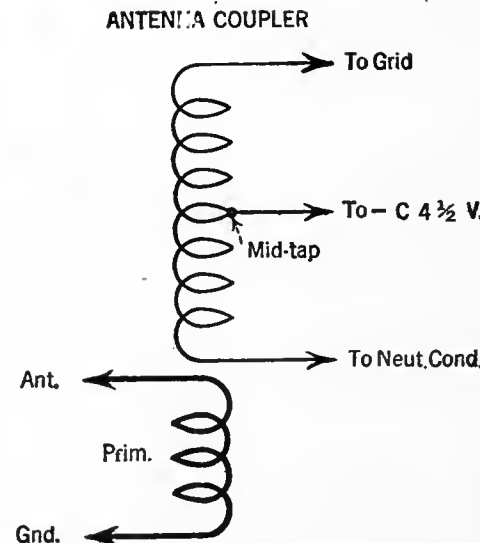

FIG. 2

paper, cambric cloth, etc. The width of this piece is about 1/8 inch, and over it is wound 15 turns of the same wire for a primary. For the interstage coupler, located between the radio frequency and detector tubes, the coil unit has

3. WHAT ARE THE SIMPLE LAWS GOVERNING THE CALCULATION OF CAPACITY IN SERIES OR PARALLEL?  
J. C.—Chicago, Illinois.
4. PLEASE PUBLISH A GOOD THREE TUBE R. F. CIRCUIT FOR A RECEIVER EMPLOYING ONE STAGE OF IMPEDANCE-COUPLED AUDIO FREQUENCY AMPLIFICATION.  
H. H. McC.—Dayton, Ohio.

a tap at the 20th turn from the grid end of the secondary. The antenna coil unit has its secondary tapped at the center turn. The circuit connections are shown in Figs. 2 and 3

### ELIMINATING THE REFLEX IN THE ROBERTS CIRCUIT

THE RADIO BROADCAST Knockout four-tube receiver has enjoyed widespread popularity for more than a year, and is still going strong. For many it has proven to be the "par excellence" circuit.

In such a highly specialized circuit where each branch has its own important rôle to play, there is bound to be trouble when constructors disregard the simple fundamental rules of receiver design, or where cheap parts are substituted for those recommended.

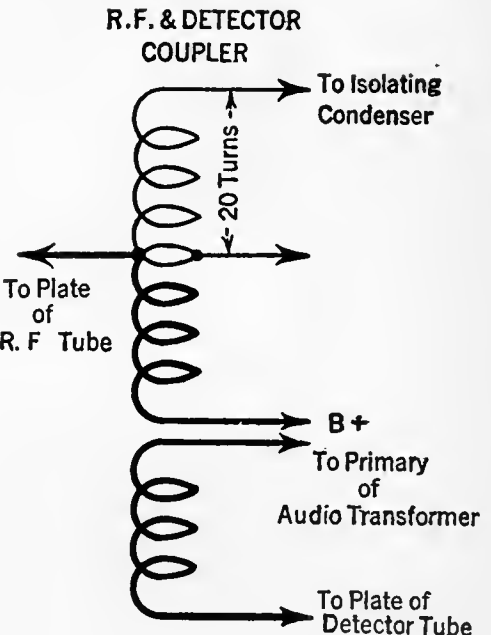

FIG. 3

Reflex, at its best, is a system of dual amplification that must be handled with utmost consideration and, when installed properly in a receiver, offers advantages, economically and electrically, that cannot be seriously disregarded.

However, there are those who, in attempting to rid their receiver of the troubles caused by an inefficient reflex system, desire to eliminate the reflex feature entirely and substitute for it a stage of straight audio frequency amplification.

The circuit-changes necessary to make-over a four-tube receiver are few, and are shown in Figs. 4 and 5. In Fig. 4 the regular four-tube circuit is shown. Fig. 5 shows the new circuit,

# The *New* NATIONAL EQUICYCLE Condenser

The latest development in straight line frequency control as applied to NATIONAL Condenser design. Increases range of rotation from 180° to 270°, permitting more precise adjustment and sharper separation of stations, and accomplishes this **WITHOUT GEARS, CAMS, OR LEVERS.**

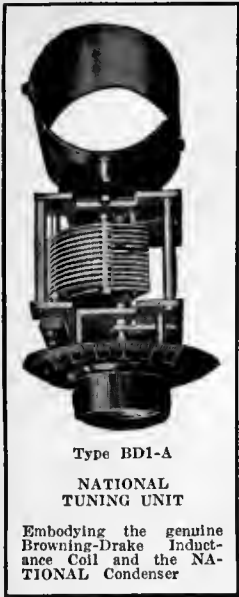

Type BD1-A  
NATIONAL TUNING UNIT

Embodying the genuine Browning-Drake Inductance Coil and the NATIONAL Condenser



Type BD2-A  
NATIONAL TUNING UNIT

Embodying the genuine Browning-Drake Transformer and the NATIONAL Condenser

*It changes a mob into an orderly procession*

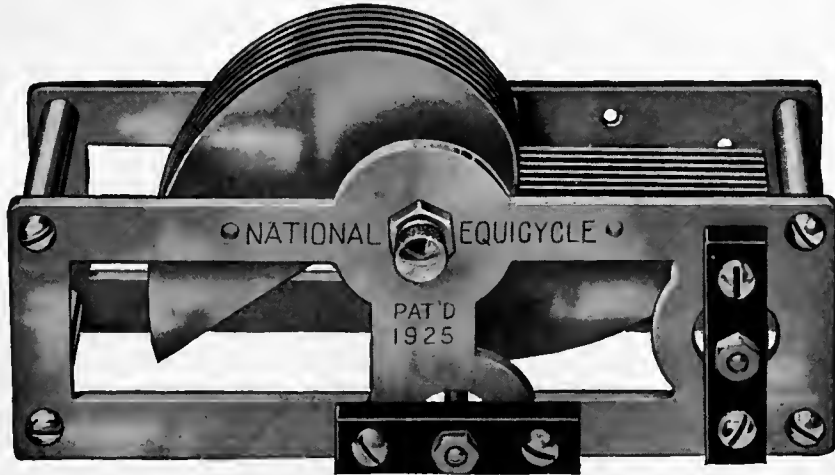

(Patented February 10, 1925)

*and lengthens the line of march!*

Tests Conducted at Harvard University, by Prof. Field, give characteristics of the new Equicycle Condenser as indicated by the following graph:

—The novel shape of the plates spaces the station groups at equal intervals of 10 kilocycles (as specified by the U. S. Department of Commerce) in a true straight frequency line.

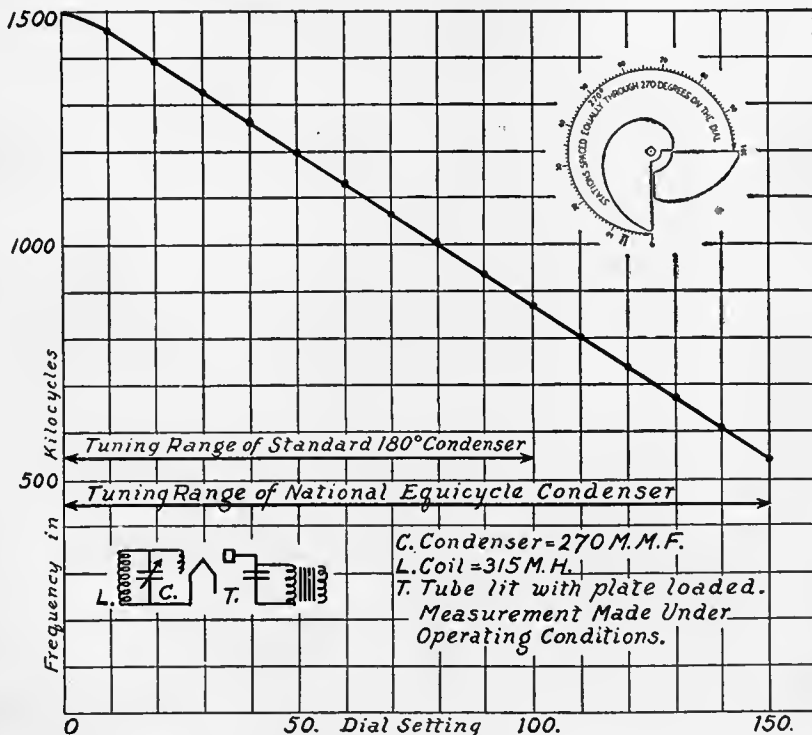

—The same electrical efficiency and mechanical ruggedness that have always characterized NATIONAL DX Condensers have been embodied in the *new* NATIONAL EQUICYCLE Condenser.



Type B  
NATIONAL VELVET VERNIER DIAL

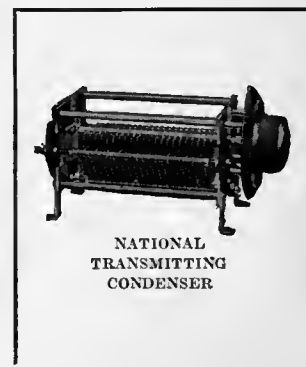

NATIONAL TRANSMITTING CONDENSER

Get the Genuine. Insist upon NATIONAL COMPANY'S RADIO Products. Your dealer appreciates your patronage and will gladly get them for you. Write for Bulletin III-RB

**NATIONAL COMPANY, Inc.**

W. A. READY, PRESIDENT

110 Brookline St.

Cambridge, Mass.

★ Tested and approved by RADIO BROADCAST ★

# A BETTER LEAD-IN

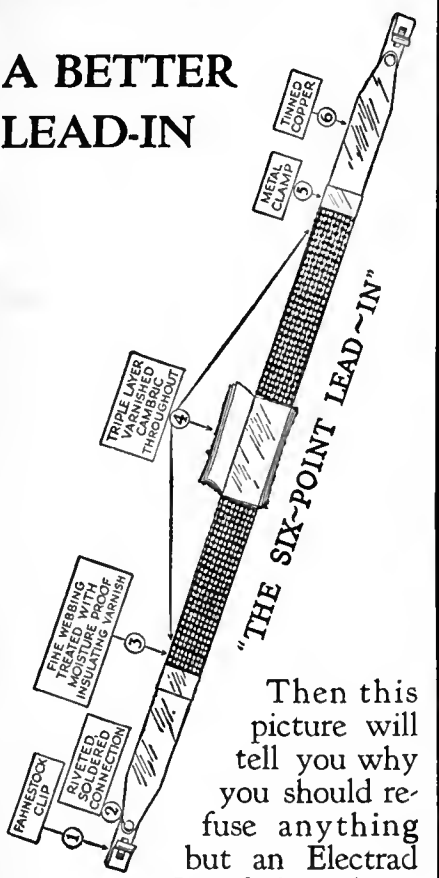

Then this picture will tell you why you should refuse anything but an Electrad Certified Lead-In.

Saves marring your window or door frames. Fits under locked windows. Bends to any desired shape. Imitations do that too, but they stop there. Notice what else you obtain in this Electrad Lead-In. Insulation, 10 inches long, waterproofed and protected entire length. Riveted and soldered Fahnestock clips.

Sold at all good radio stores and counters. Price 40c. Canada 60c. Ask for it by name. For safety's sake refuse imitations.

For Clearer Purer Reception Do This

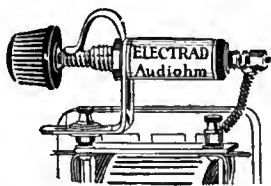

Place an Electrad Audiohm across the secondary of your audio-transformer. Then you will enjoy your radio. Kills distortion, eliminates squeals and howls. Fits all audio transformers. Easy to attach. For sale at good radio stores and counters. \$1.50. Canada \$2.10.

# ELECTRAD INC.

428 Broadway New York  
Makers of Certified Radio Essentials and Accessories: Grid Leaks, Fixed Condensers, By-Pass Condensers, Variometers, Resistances, Rheostats and Potentiometers, Jacks, Switches, etc. Write for catalog.

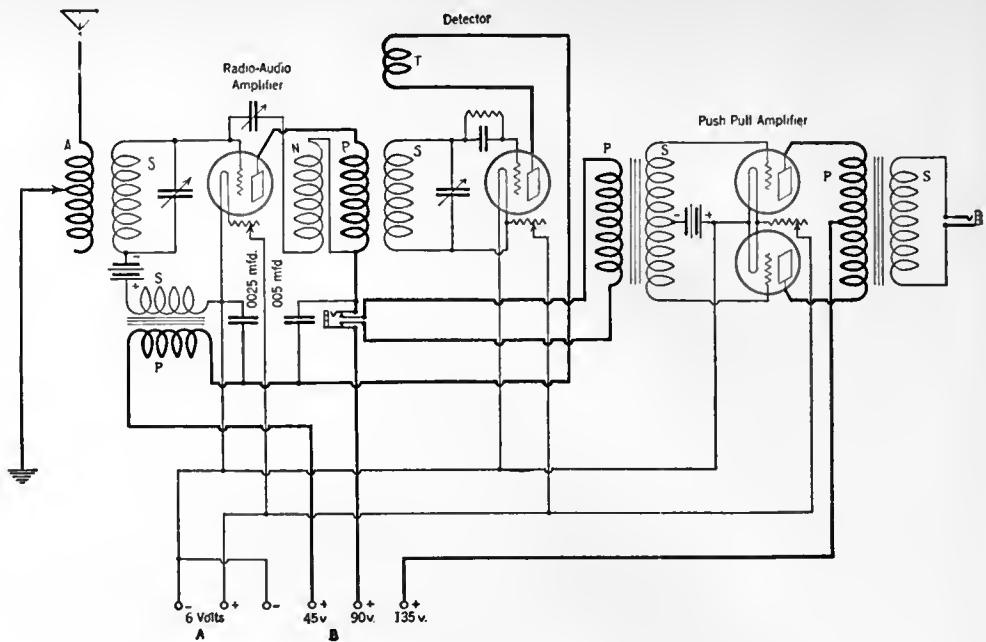

FIG. 4

the dotted lines indicating that part of the former circuit which was reflexed. It may be observed from these two circuit sketches that the audio transformer employed as the reflex agent is merely eliminated from its position and re-located as the transformer for the first straight audio amplifier. The primary

but has not the correct size, as recommended, on hand.

It is quite a simple matter to get over this, however, by the combination of a variable and a fixed condenser.

For example, suppose a condenser of .001 mfd. is desired. By shunting the usually handy .0005 variable condenser with a fixed .0005 mfd. condenser, the desired capacity is obtained.

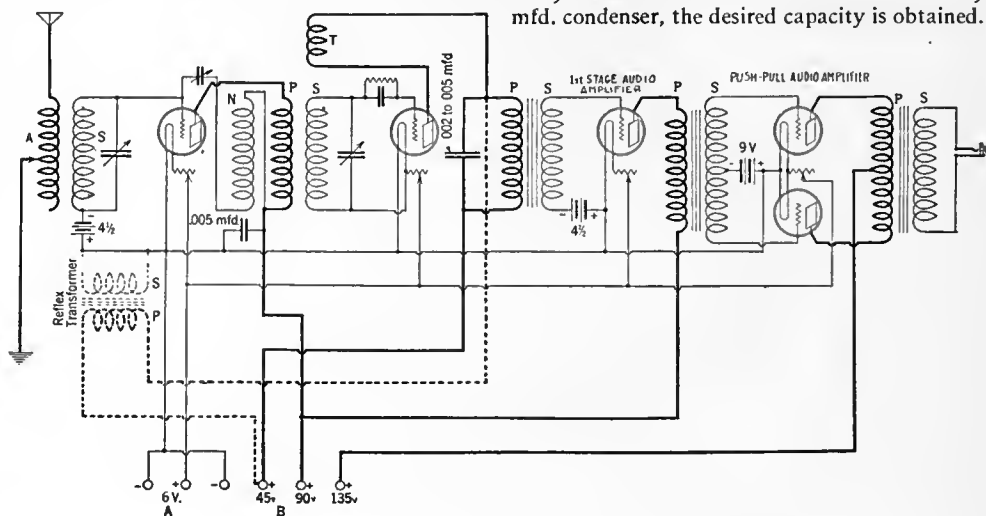

FIG. 5

of the push-pull input transformer, instead of being in the plate circuit of the radio frequency tube, is in the plate circuit of the new audio stage.

With the new circuit, where UX-112 tubes are used in the push-pull amplifier, well-nigh perfect reproduction will result. With the use of this type of tube, it is essential that 9 volts C battery be employed as a grid bias for the push-pull amplifier, with 135 volts plate potential.

If, with this same variable condenser, it is desired to lower the total capacity in a circuit to which it is applied, then a condenser in series with it will produce the desired result.

In the first case—the fixed condenser in parallel arrangement—the minimum capacity that can be obtained with the plates of the variable

condenser completely unmeshed will be greater than when only the variable condenser alone is used, by a capacity equal to that of the fixed condenser used. If the minimum capacity of the variable condenser is .000025 mfd., the total minimum capacity of the two condensers is .000025 plus .0005 mfd. See Fig. 6. If the condensers are arranged in series, as in

### CONDENSERS IN SERIES AND PARALLEL

IT IS often the case that the radio man will require a condenser of a certain specified capacity when experimentally hooking up a new circuit

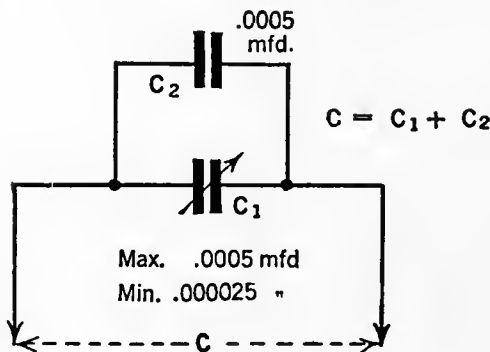

FIG. 6



*“Your radio is always top notch.  
What do you do to keep it so full  
of pep?”*



KEEPING your “B” batteries full of pep, without frequent renewals, is simply a matter of using the right size Evereadys for your particular set with a “C” battery\*.

The rule which determines the right size “B” batteries to use is so simple no one can make a mistake, and once learned it definitely settles the question of “B” battery service and economy.

*On 1 to 3 tubes — Use Eveready No. 772.*

*On 4 or more tubes — Use the Heavy Duty “B” Batteries, either No. 770, or the even longer-lived Eveready Layerbilt No. 486.*

*On all but single tube sets — Use a “C” battery.*

When following these rules, No. 772, on 1 to 3 tube sets, will last for a year or more, and Heavy Duties on sets of 4 or more tubes, for 8 months or longer.

These life figures are based on the established fact that the average year-round use of a set is 2 hours a day.

A pair of Eveready No. 772's for a 5-tube set

instead of 2 Eveready No. 770's or 2 Eveready Layerbilts No. 486—looks at first glance like an economy because of lower first cost. But in a few months the 772's will be exhausted and have to be replaced. After the same length of time the Eveready No. 770's or the Eveready Layerbilts No. 486 will still be good for many more months of service.

We have prepared for your individual use a new booklet, “Choosing and Using the Right Radio Batteries,” which we will be glad to send you upon request. This booklet also tells about the proper battery equipment for use with the new power tubes.

\*NOTE: In addition to the increased life which an Eveready “C” Battery gives to your “B” batteries, it will add a quality of reception unobtainable without it.

*Manufactured and guaranteed by*  
**NATIONAL CARBON Co., Inc.**  
 New York San Francisco  
 Canadian National Carbon Co., Limited  
 Toronto, Ontario

Tuesday night means Eveready Hour—9 P. M., Eastern Standard Time, through the following stations:

- |                  |                    |
|------------------|--------------------|
| WEAF—New York    | WSAI—Cincinnati    |
| WJAR—Providence  | WEAR—Cleveland     |
| WEEI—Boston      | WWJ—Detroit        |
| WTAG—Worcester   | WGN—Chicago        |
| WFI—Philadelphia | WOC—Davenport      |
| WCR—Buffalo      | wcco { Minneapolis |
| WCAE—Pittsburgh  | { St. Paul         |

KSD—St. Louis  
 Pacific Coast, Eveready Program,  
 KGO—San Francisco, 8 to 9 P. M.



LEFT—No. 486,  
for 4, 5 or more  
tubes. \$5.50.



RIGHT—Eveready Dry Cell Radio “A” Battery, 1½ volts.

# EVEREADY

## Radio Batteries

—they last longer

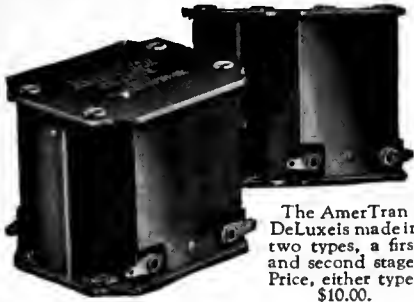

The AmerTran DeLuxe's made in two types, a first and second stage. Price, either type, \$10.00.

**A New Standard of Excellence in Audio Amplification**

The realism of this new audio transformer is outstanding. Realism of this kind results from the uniform amplification of the fundamental tones of the lower register. The AmerTran DeLuxe makes possible the natural reproduction of not only the Overtones, but all of the transmitted Fundamental tones.

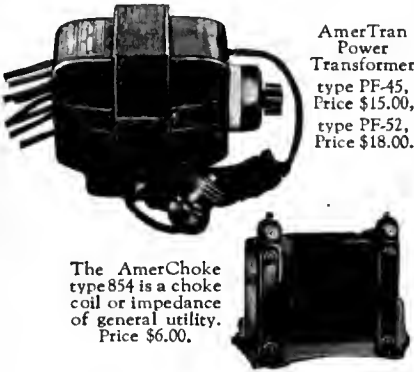

AmerTran Power Transformer type PF-45, Price \$15.00, type PF-52, Price \$18.00.

The AmerChoke type 854 is a choke coil or impedance of general utility. Price \$6.00.

**A Good Audio Amplifier**

Requires enough plate and grid bias voltage on its tubes to prevent them from being overloaded by the signal voltage.

The AmerTran PF-45 or PF-52 with the half wave high voltage rectifying tubes now available and suitable condensers and resistances—together with three AmerChokes Type 854 will furnish these proper voltages. This combination will give real quality loudspeaker volume. AmerTran Power Transformers also supply A. C. filament current for the last audio tube.



AmerTran Audio Transformers type AF6 (turn Ratio 5) and AF7 (turn ratio 3½) are the leaders in their class. Price, either type, \$5.00.

Write for booklet describing these and other AmerTran Products—with recommendations on their use. It's free on request. All prices are F. O. B. Newark, N. J.

**AMERICAN TRANSFORMER CO.**  
178 Emmet Street, Newark, N. J.  
"Transformer builders for over twenty-five years"  
Sold Only at Authorized AmerTran Dealers.

Fig. 7, then the minimum capacity of the circuit is calculated by the following formula:

$$C = \frac{1}{\frac{1}{C_1} + \frac{1}{C_2}}$$

where C<sub>1</sub> equals the minimum capacity of the variable condenser (.000025 mfd.) and C<sub>2</sub> equals

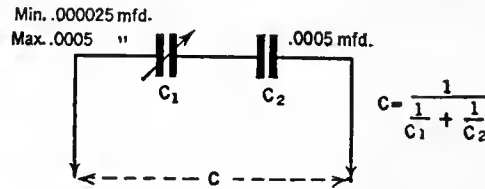

FIG. 7.

the capacity of the fixed condenser. By substitution in this formula, we get:

$$C = \frac{1}{\frac{1}{.000025} + \frac{1}{.0005}} = \frac{1}{.00021} = .000024 \text{ mfd.}$$

The same formula may be applied for finding the maximum capacity of the arrangement, the maximum capacity of the variable condenser being substituted for C<sub>1</sub>.

AN IMPEDANCE-COUPLED AUDIO AMPLIFIER

FOR a means of amplifying audio frequencies, the impedance method is commendable because of its simplicity of connection, and also because use can be made of discarded transformers or other coils. From the circuit in Fig. 8 it will be seen that all that is necessary for a coupling agent between the regenerative detector tube and the first audio tube, is a coil having an iron core. Of course, this

coil unit should have certain definite dimensions for most efficient functioning, but it has been found that such coil units as the secondary of a transformer which has been rendered useless by a burned-out primary, or the wire-wound bobbins of discarded head phones, are satisfactory make-shifts for an amplifier unit. The connections for an entire receiving circuit, showing the application of an impedance or choke coil to it, are clearly indicated in the accompanying circuit diagram.

The two tuning units in this circuit are standard coupler units. In the antenna unit, the secondary coil is tapped at the mid-turn for the filament return connection. Rice neutralization is employed. The neutralizing condenser is connected between the plate of the radio frequency tube and the lower end of the first coil-unit secondary. These connections are clearly shown in the diagram. The value of the neutralizing condenser is .000016 mfd. The tuning condensers are both about .0005 mfd.

The similarity between impedance and resistance audio amplification is apparent from a glance at the circuit diagram. In resistance amplification a resistor of approximately 100,000 ohms is substituted for the impedance coil, and there is a B battery voltage drop across the plate resistance. Any variation in voltage causes a corresponding voltage variation in the resistor, and these voltage variations are applied to the grid of the succeeding tube, and magnified by the latter's action. For an impedance amplifier, the general action is much the same, with the exception that, instead of utilizing the voltage drop across a resistance, the variation in voltage across an inductance is used. It is essential that the isolating condenser C, should be of the highest quality, one of mica dielectric being recommended.

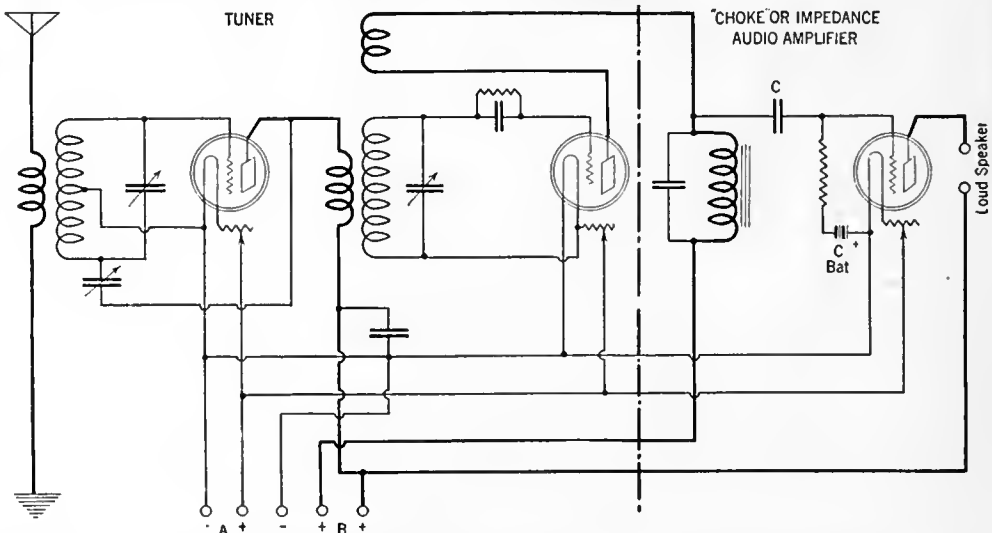

FIG. 8.

GRID INQUIRY BLANK

Editor, The Grid  
RADIO BROADCAST  
Garden City, New York

DEAR SIR,

Please give me the fullest information on the attached questions. I enclose a stamped envelope.

- I am a subscriber to RADIO BROADCAST and therefore will receive this information free of charge.
- I am not a subscriber and enclose \$1 to cover cost of answers.

NAME.....

ADDRESS.....  
G. A.



# Hammarlund Roberts

## Acclaimed from Coast to Coast

### Testimonials on the Hammarlund-Roberts Receiver

1

Grandview, Washington

Last night I received PWX at Havana, Cuba on the loud speaker. Other stations that I get regularly are: WRGB at Atlanta, Georgia; WSM, Nashville, Tenn.; WOY, Schenectady, N. Y.; WSMB, New Orleans, Louisiana; CZE, Mexico City, Mexico. Ready to back your set against any other of the same size. Logged over 100 stations the first week.  
R. F.

2

Butte, Montana

During tests the Hammarlund-Roberts was installed in the Butte Radio Club Headquarters and dista set for 2L0. Immediately we were able to get through for a few moments, long enough to hear announcements made in English, German, and Spanish. This was followed by both instrumental and vocal music.  
M. R. C.

5

Wheeling, W. Va.

On January 25th, 1926, I picked up 7EAJ of Madrid, Spain. Reception was so loud and clear from the cone speaker, it was desirable to cut the volume considerably. I have received CZE of Mexico City and PWX of Havana, Cuba; both of these stations I have received before these tests however. I have logged over 90 stations and more are coming in all the time.  
N. E. C.



## Thousands Have Built It!

**S**IMPLICITY of assembly is an outstanding feature of the Hammarlund-Roberts receiver. Thousands of amateur builders in all parts of the country testify enthusiastically to the ease of assembling this circuit and express their delight at the results secured by their own handiwork.

The secret of their success lies in the flawless technique of every part entering into the assembling of this set. The Hammarlund-Roberts receiver represents the composite achievement of ten leading engineers, backed by ten of the best known manufacturers of radio parts. Every part is the work of a specialist and has been chosen because it meshes easily and yet efficiently with every other related part in the set.

After you have assembled this receiver you will want your friends to call around and judge for themselves your ability as a radio engineer. And your pride will be justified. The Hammarlund-Roberts receiver combines remarkable volume and sensitivity with an unusual degree of selectivity and tone quality. As for distance—you have on either side enthusiastic testimony by users of the Hammarlund-Roberts in all sections of the country. A perusal of these comments will revolutionize all your previous ideas of five-tube performance. Should you desire to verify any of these reports we will be glad to furnish you with full name and address on request.

7  
Washington, D. C.

Each evening during the tests, I logged in no less than a dozen stations. However, regenerative sets absolutely ruined reception. I was able to make out only partly some station in South America operating at 300 meters. From results obtained I am sure that Hammarlund-Roberts is capable of Trans-Atlantic Reception. I feel that Hammarlund-Roberts is one of the best buys in radio today.  
G. J. A.  
Electrical Engineer

9

Williamsport, Pa.

We have tested the Hammarlund-Roberts and find it to be exactly as you recommended. Surprising volume and very clear and deep tone, exceedingly selective.  
H. B. S.

10

Lansing, Mich.

On the first night of the Trans-Atlantic Tests, I had PWX, Havana, Cuba, on the loud speaker, so loud that it could be heard at times all over a six-room house. Have not heard of anyone beating this record. I have ten witnesses to this reception.  
J. R.

13

Morristown, Tennessee

I assembled the Hammarlund-Roberts Receiver in one day's time. The set is highly efficient and up to all claims made by you. I have owned many factory built sets and will say that the Hammarlund-Roberts is superior to them all. This set is capable of building up tremendous volume without distortion and behaves like a thoroughbred. I get New York, Atlantic City, Jacksonville, San Francisco, Montreal, Havana, Cuba, and Mexico City.

# Hammarlund Roberts

Hammarlund-Roberts 1182-A Broadway, New York City

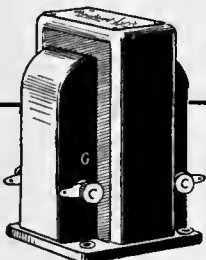

This famous instrument and other parts shown here are some of the quality units in the Hammarlund-Roberts.



RHEOSTATS



DURHAM RESISTORS

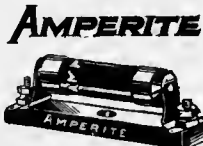

AMPERITE



UNION PHONE TIP JACKS



DIALS and SOCKETS

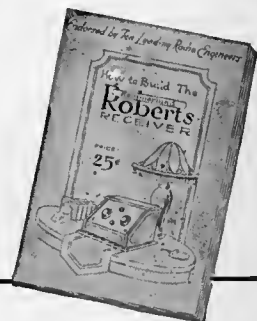

SEND FOR THIS BOOK

Contains step-by-step instructions on the assembly, wiring and operation of the Hammarlund-Roberts. Fully illustrated; most complete "How to Build It" radio book ever published. 25c.

Send for this  
New Hookup

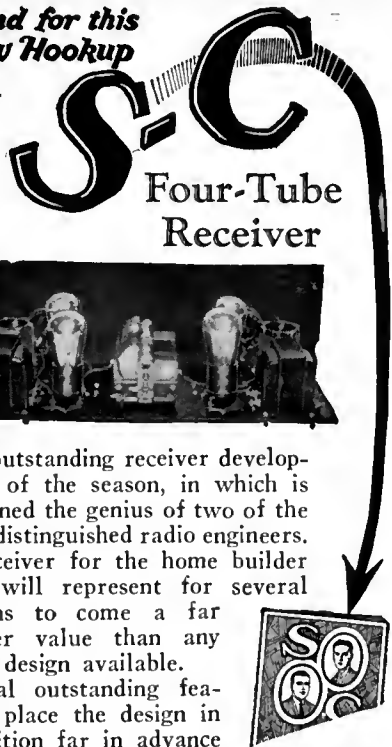

The outstanding receiver development of the season, in which is combined the genius of two of the most distinguished radio engineers. A receiver for the home builder that will represent for several seasons to come a far greater value than any other design available. Several outstanding features place the design in a position far in advance of anything available or contemplated. Unlimited wavelength range, with interchangeable antenna and detector coils; marvelously improved audio transformers; a special self-contained wiring harness; but one tuning or station selector control, are special features. Over-all design is rugged and solid. Adapted to practically any standard cabinet, any standard tube, any battery or eliminator source of supply, outdoor antenna or loop. Only a screw driver and pair of pliers necessary. The set can be built at an extremely low cost and parts are readily available at all radio dealers.

**Represented Manufacturers:**

- Belden Mfg. Co.—S-C Wiring Harness
- Central Radio Laboratories—Centralab Resistance
- Polymet Mfg. Corporation—Fixed Condensers, Leak, and Leak Clips
- Poster & Co.—Drilled and Processed Front Panel and Drilled Sub-Panel
- Silver-Marshall, Inc.—Variable Condensers, Coil Sockets, Coils, Tube Sockets, Vernier Dial, Mounting Brackets
- Thordarson Elec. Mfg. Co.—R200 Power Transformers
- Yaxley Mfg. Co.—Rheostat, Jacks, Switch

Get the hand-book at your radio dealer's, or clip the coupon and send 25 cents to

**S-C MERCHANDISING COMPANY**

65 E. Jackson Blvd. Chicago

**S-C Merchandising Company**

65 E. Jackson Blvd., Chicago

Herewith please find 25 cents for which send me the hand-book of the new S-C Four-Tube Receiver

Name .....

Address .....

“NOW, I HAVE FOUND . . .”

A Department for the Exchange of Ideas and Suggestions of Value to the Radio Constructor and Operator

CONTRIBUTIONS to this department are welcome and those used will be paid for at the usual rates, that is, from two to ten dollars each. A prize of twenty-five dollars is given for the best idea used during each three-month period. The prizewinner for the last period was announced in the February RADIO BROADCAST. Manuscripts intended for this department should not exceed about three hundred words in length, and should be typewritten. Little consideration can be given to manuscripts not typewritten. Envelopes should be addressed to this department, RADIO BROADCAST, Garden City, New York.

BETTER REPRODUCTION IN CONE SPEAKERS

AN EASY way to eliminate the jingle in the high notes and reproduce the bass notes more faithfully in a cone loud speaker, taking as an example the Western Electric No. 540 AW, is as follows:

Loosen the set screw in front which holds the pin, then remove the screws in the back thus allowing the metal ring, fibre ring, and screen to be removed.

This exposes the telephone unit held to the frame by three screws. First, mark the frame where the unit is held to it so that it can be put back in the same place, and then remove the screws and carefully lift out the unit.

Remove the screw holding the pin to its support and insert a piece of electric tape between these two members, first making a hole through the tape for the screw to go through. Replace the screw.

Then slip over the pin a rubber tube  $\frac{1}{8}$  inch or more in thickness reaching from the base of the pin to just short of the parchment, and having its bore slightly smaller than that of the pin, so as to grip it tightly. With the use of this system, the possibility of bending or otherwise injuring the pin by loading it with rubber tape is avoided. See Fig. 1.

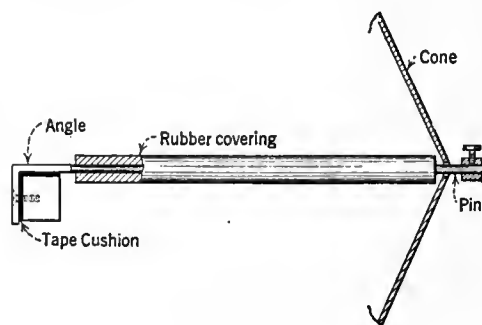

FIG. 1

Re-assemble, taking care to have the pin straight and to put the telephone unit back in the same place on the frame as marked. Tighten the screw in front to the pin.

Before replacing the screen, tune in on some good station and test out the speaker. If there is any jingle leave the set screw in front secured to the pin, loosen up the screws holding the telephone unit to the frame, and move the unit until the jingle disappears and the best reproduction is obtained. Then tighten up the screws.

Replace the screen and rings, thoroughly tightening up all screws.

WILLIAM C. MORRILL, E. E.  
New York.

HOW TO PROVIDE A COUNTERPOISE SYSTEM

THOSE who use the Roberts or Browning-Drake circuits and are troubled with broad tuning antenna couplers, might well use the single inductance with a conductively coupled antenna, placing the antenna tap about one third up

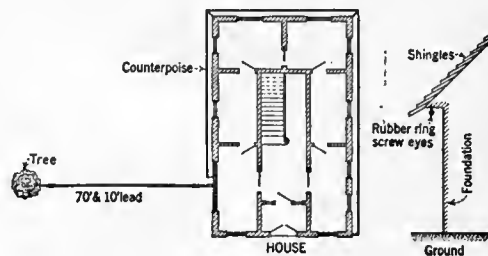

FIG. 2

from the filament end of the inductance, and grounding the negative A battery line.

For those who have the space or who live in shingled houses, the substitution of a counterpoise for a ground (entirely eliminating the ground will materially sharpen the tuning and in my case was found to produce much clearer signals, with greater intensity, than with the ground. The lower edge of the shingles generally stops about 3 feet from the ground and overhangs the foundation wall by several inches. Small insulated screw eyes placed under the shingle-overhang all the way around the house will hold a good counterpoise. If the shingles go all the way to the ground, a row of screw eyes about the height of the doorways will work almost as good. See Fig. 2.

My antenna combination is now an 80-foot antenna and a 100-foot counterpoise.

J. B. GREENMAN,  
Montclair, New Jersey.

SOME NOTES ON SILVER'S MODEL 1926 RECEIVER WITH CHOKE AMPLIFICATION

VARIATIONS on the theme of McMurdo Silver's "Model 1926 Broadcast Receiver," introduced to its readers in the November, 1925, number of RADIO BROADCAST, were presented by E. R. Pfaff in the January, 1926, number. Before the appearance of the latter article, the writer had constructed a receiver of this type using Thordarson Autoformer audio amplification. As the set was constructed for experimental purposes, and this circuit is peculiarly adapted to this end, one or two wrinkles used may be of interest. As described, the set has no binding

# Faradon

## ELECTROSTATIC CONDENSERS

19 YEARS OF SPECIALIZATION  
IN THE RADIO FIELD

are behind each Condenser Trade Marked

### Faradon



In Radio Receiving Sets

The Biggest Little Things Are  
The **FIXED CONDENSERS**

The **MODEL T FARADON** is furnished in all usual sizes to meet the requirements of Quality Performance.

Quotations covering quantity requirements furnished  
to  
**SET MANUFACTURERS**  
promptly upon request.

*Some Important FARADON Users:*

U. S. Army	General Electric Co.
U. S. Navy	Radio Corp. of America
U. S. Signal Corps	Western Electric Company
U. S. Bureau of Standards	Tropical Radio Tel. Co.
Westinghouse Electric & Mfg. Co.	



TYPE I TERMINALS

*For Soldered Connections in Any  
Portion of Circuit*



TYPE II TERMINALS

*Holds Standard Cartridge Grid Leak—  
Also Takes Soldered Connections*

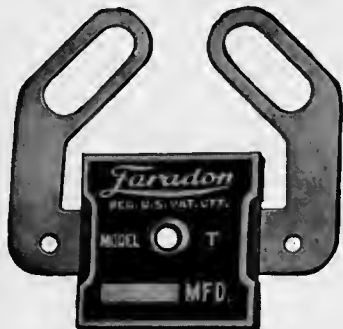

TYPE III TERMINALS

*For Transformer or Other Binding  
Post Mounting  
Also Takes Soldered Connections*

**WIRELESS SPECIALTY APPARATUS COMPANY**  
JAMAICA PLAIN — BOSTON, MASS.

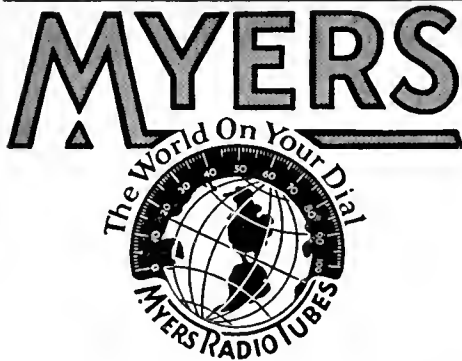

**Seven Years of Superiority**

KNOWN as the original HI-MU tubes before the days of BCL;

Preferred by amateurs and experts before the first popular receiving set was sold;

Progressively improved in construction and performance;

Made in the newest and best equipped plant in America.

**Get the World on Your Dial With Myers Tubes**

Low impedance, high amplification constant, high mutual conductance. Best results in any circuit — impedance, resistance or transformer coupled.

At Your Dealer's  
**Myers Radio Tube Corporation**  
Cleveland, Ohio

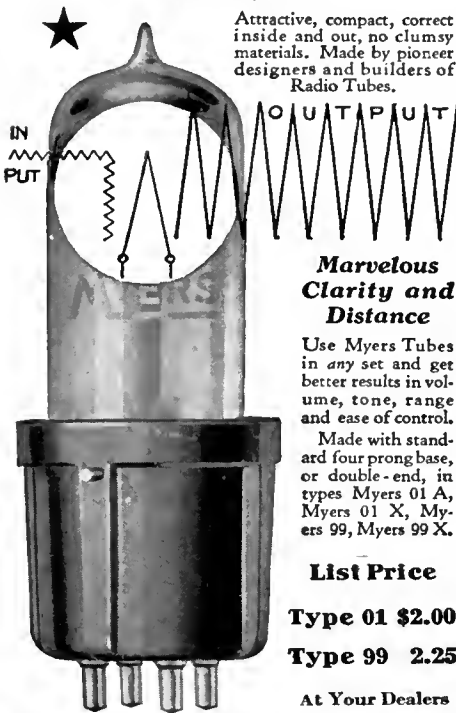

Attractive, compact, correct inside and out, no clumsy materials. Made by pioneer designers and builders of Radio Tubes.

**Marvelous Clarity and Distance**

Use Myers Tubes in any set and get better results in volume, tone, range and ease of control.

Made with standard four prong base, or double-end, in types Myers 01 A, Myers 01 X, Myers 99, Myers 99 X.

**List Price**  
**Type 01 \$2.00**  
**Type 99 2.25**

At Your Dealers

posts, the ends of a Belden battery cord being attached directly to various terminals, transformer, switch, etc., in the set. For experimental purposes, it is handier to use binding posts, however. Choke amplification may be used with either 90 or 120-135 volts of B battery. In case 90 volts of B battery is used, the 90 volts go to both r.f. and a.f. amplifiers, while the detector receives 45 volts. If, however, it is desired

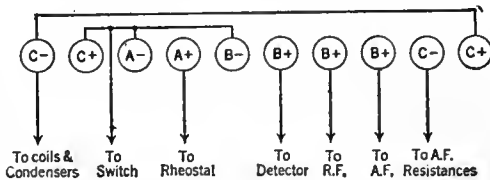

FIG. 3

to employ 120-135 volts of B battery on the last audio stage, then the r.f. amplifier and the first two stages of audio receive 90 volts. There are three separate units to be provided for, the r.f., 1st and 2nd a.f. amplifiers, the detector, and the last a.f. amplifier stage. If three B plus binding posts are used, one for each unit, the a.f., r.f., or the detector may be quickly connected at the binding posts to facilitate the use of various values of B potential without tearing the set apart.

The December, 1926, RADIO BROADCAST contained two very interesting articles on the use of high-mu tubes, one by Keith Henney and the other by Glenn H. Browning. The latter describes the use of Daven

directly from a 6-volt battery. A switch of the midget type mounted inside the set makes this change simple.

To care for added C battery (6 to 7½ volts) to the a.f. circuit, an extra pair of C binding posts may be used to advantage, as indicated in Fig. 3.

DAVENPORT HOOKER,  
Pittsburgh, Pennsylvania.

**A HOME-MADE COIL WINDER FOR DIAMONDWEAVE COILS**

THOSE preferring to "roll their own" will find in the accompanying sketches, Figs. 4, 5, and 6, sufficient instructions to build an efficient coil winder for diamondweave coils. It consists of a wood mandrel and metal spokes for a coil form, mounted on a shaft; also a counter and a wire guide made of small thread spools, and a small screw eye to give correct tension to the wire.

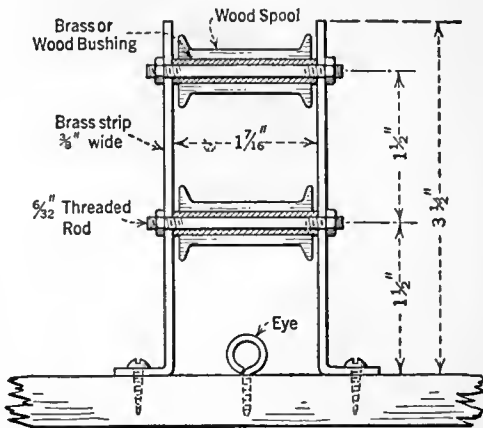

FIG. 5

Care must be taken in marking and boring to the correct size, the holes in the mandrel to take the spokes. Place the spool or wire guide in an upright position, and far enough away from the winder proper to allow easy handling of the wire with the hand (about five inches from the shaft support). To wind, run the wire through the eye and under first spool, then between the two and over the top spool; set counter and begin winding. With a little practice one can soon learn the "swing" of "over two, under two," done with the left hand.

After winding, remove the mandrel from the shaft, pull the spokes just out of the wood, but leave them engaged in the wire until sewn. About twenty nails in

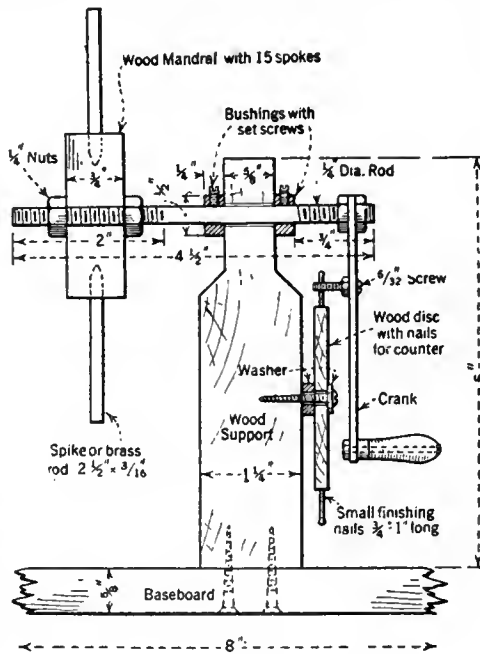

FIG. 4

high-mu tubes in conjunction with National chokes, using 90 volts of B battery. When two Daven MU-20 and one Daven MU-6 (in the last stage) are used in the "Model 1926 Receiver" with Thordarson chokes on 90 volts, an appreciable gain in volume is experienced. When, however, 120-135 volts of B battery are used in the a.f. circuit, as suggested by Mr. Henney, the receiver talks right out. Furthermore, quality is not sacrificed.

When Daven tubes are used, the rheostat lead to these tubes may be disconnected from the rheostat and connected directly to the current supply, as these tubes operate

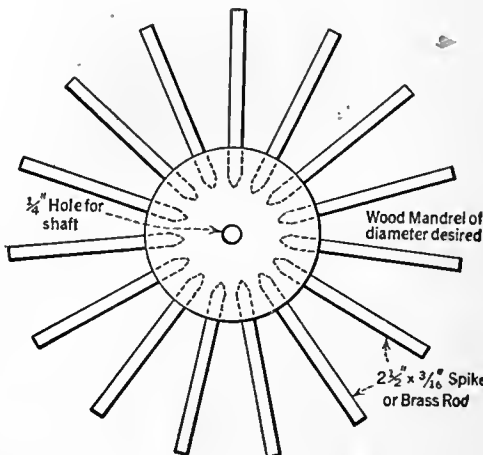

FIG. 6

**JEWELL**

**No. 135-A**

SEND FOR  
New No. 739 Circular describing special voltmeters for Radiola, Victor and Brunswick sets

Order from Dealer

**Jewell Electrical Instrument Co.**  
1650 Walnut St. Chicago  
"26 Years Making Good Instruments"

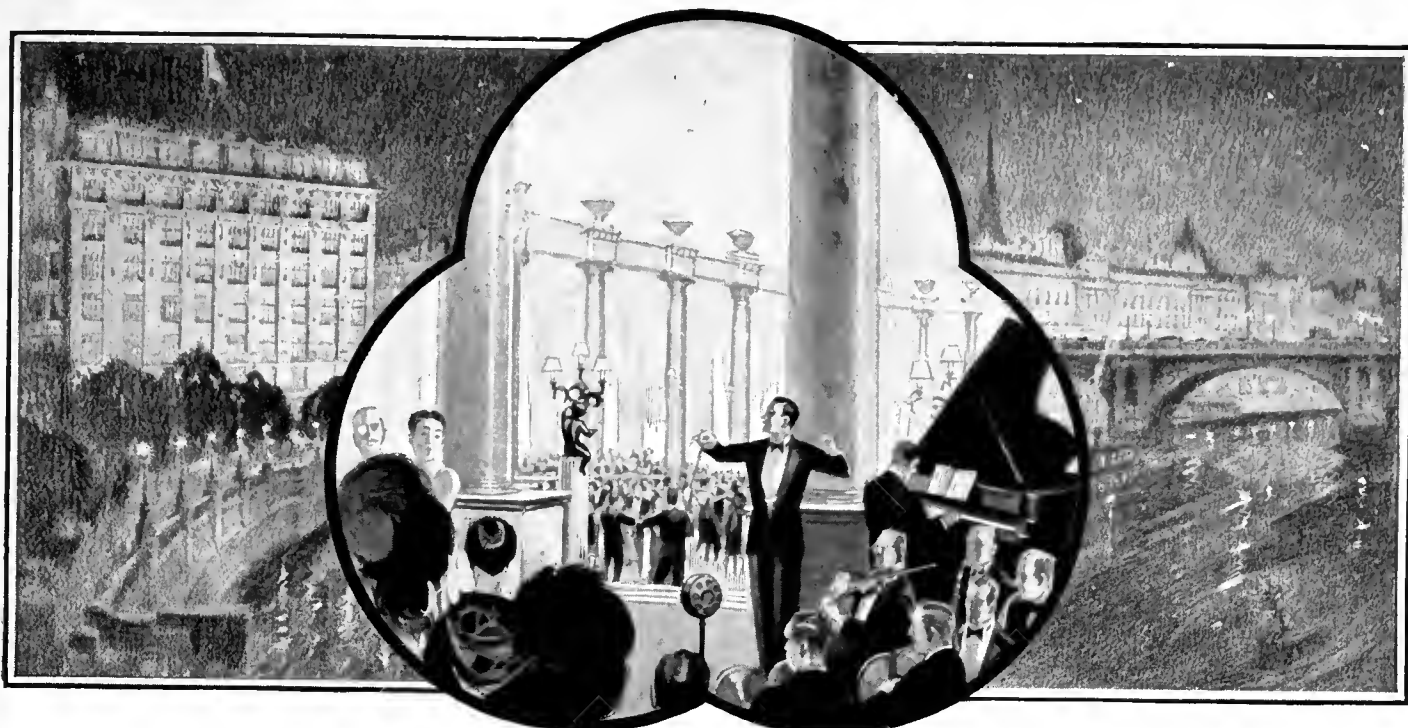

*“This is Station 2-L.O. London,—12 Midnight”*

**W**HEN listeners-in on this side of the Atlantic first heard the voice of the British announcer, and then a program of music from the famous Savoy in London, they experienced one of the real thrills of radio.

To get everything that is on the air—the faint signals as well as the strong ones—effective insulation of all radio parts is a prime essential. The best way to make sure that a radio set or parts are well insulated, is to buy those in which Bakelite is used.

Bakelite is used by 95% of radio set and parts manufacturers. It is the standard material for front and base panels, dials, knobs, tube sockets and bases, fixed and variable condensers, rheostats, plugs and other radio accessories and parts. Write us for a copy of Booklet No. 29, “Bakelite in Radio”—it’s a helpful guide in buying radio equipment.

**BAKELITE CORPORATION**

247 Park Avenue, New York, N. Y.  
Chicago Office: 636 West 22nd St.

BAKELITE CORPORATION of CANADA, Ltd.  
163 Dufferin Street, Toronto, Ontario, Canada.



**BAKELITE**

REGISTERED U. S. PAT. OFF.



THE MATERIAL OF A THOUSAND USES

“The registered Trade Mark and Symbol shown above may be used only on products made from materials manufactured by Bakelite Corporation. Under the capital “B” is the numerical sign for infinity, or unlimited quantity. It symbolizes the infinite number of present and future uses of Bakelite Corporation’s products.”

★ Tested and approved by RADIO BROADCAST ★

# screw machine products —brass



For plugs, jacks, clips, condenser and transformer parts, etc., BRASS assures economy in quantity production. It also gives the right electrical conductivity and the mechanical accuracy essential to proper operation of radio sets and parts.



**COPPER & BRASS**  
RESEARCH ASSOCIATION

25 Broadway, New York

## KILL! STATIC! Without Loss of Volume

### ELIMINATE STATIC

Enjoy perfect reception regardless of weather conditions. The Static Eliminator—the newest and most startling thing in Radio—cuts out practically all static without loss of volume! And in addition it will help increase selectivity, tune out local stations, sharpen signals, remove noises, lessen interferences, and prevent re-radiation!

Use it with any receiving set—simply hook up according to our simple instructions and enjoy perfect reception unmarred by static. Satisfaction absolutely guaranteed—Money back if Eliminator is returned within 5 days. Mail your order today.



**\$1.00**  
Postpaid

**STATIC ELIMINATOR COMPANY**  
627 United Bank Bldg. Cincinnati, O.

the counter disk is correct for a two-inch disk. By means of the screw on the crank, and the counter, each turn of the crank registers one complete turn of the coil. It is easier to use two rings of heavy cardboard tubing of given diameter and half an inch in width, clamped on each side of the spokes with two pieces of heavy sheet metal, than to make various size wood mandrels. In this way, one mandrel serves for all diameter coils. Take care to center these properly on the form before winding. An excellent coil can be wound in this way. These coils give fine results in a RADIO BROADCAST "Knockout" receiver.

#### MATERIAL REQUIRED

- 1—4½-inch x ¼-inch metal rod for shaft (60 penny spike will do).
- 1—Piece of hard wood ¾-inch wide and of diameter desired.
- 1—Piece of hard wood 5 inches x 1¼ inches (support for shaft).
- 1—Piece of heavy sheet metal 3 inches x ⅝ inches for crank.
- 15—2½-inch x ⅜-inch spikes for spokes (with heads cut off).
- 2—Pieces of brass bushing, ¼-inch inside diameter, ¼-inch wide, with set screws.
- 1—Baseboard about 15 x 8 x ⅝ inches.
- 1—Small wood disk about 2 inches diameter ¼-inch thick for counter, with some small fishing nails to go around periphery.
- 2—Wood spools of same size (thread spools.)
- 2—Pieces of ⅜-inch threaded rod 2 inches long.
- 2—Pieces of brass or wood tubing (pipe stems) ⅝ inch longer than spools.
- 2—Pieces of metal strip 4 x ⅝ inches wide to hold spools.

R. S. HART,  
Pisgah, Kentucky.

#### A HANDY BATTERY THROW-OVER SWITCH

WHEN a vibrating magnetic rectifier, such as the "Homcharger," is employed to charge the storage battery, it is necessary to observe the following procedure:

To charge:

1. Disconnect battery from receiver.
2. Connect charger to line supply (110 volts a.c., 60 cycles).
3. Connect battery to charger.

To discharge:

TO  
A.C. SUPPLY

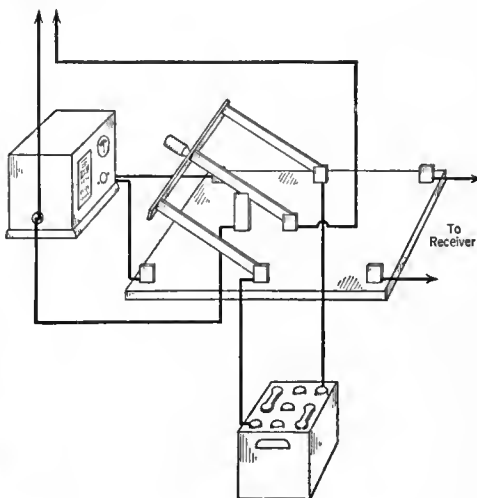

FIG. 7

1. Disconnect battery from charger.
2. Disconnect charger from mains.
3. Connect battery to receiver.

To eliminate the clumsy connection and removal of clips, the author has devised a simple arrangement whereby the complete process of connection necessary to the proper charge and discharge of the battery is controlled merely by the movement of a double-throw switch.

The switching device is illustrated in the accompanying diagram, Fig. 7. The dimensions of the switch itself are unimportant, so long as the extra contact which connects the charger to the line supply is made large enough so that the switch blades connected to the battery are entirely clear of their contacts before the line supply is cut off.

BERNARD SALZBERG,  
New York City.

#### ECONOMICAL SUB-PANEL BRACKETS

BEING suddenly faced with the necessity of making a pair of brackets for a sub-panel, I tried the following:

Get from a good hardware or plumbing supply store, a piece of ⅜-inch channel brass, ½-inch wide. This will be shaped as shown in 1, Fig. 8.

Measure how far the bracket must project back from the front panel and add about two inches for support to fasten on to the front panel. At the point where you wish to bend the strip make a cut, perpendicular and square across, with a hack saw, merely cutting through the side walls as illustrated in 2, Fig. 8.

Then, with a three-cornered file, widen the saw cut to a "V" shaped notch, as in

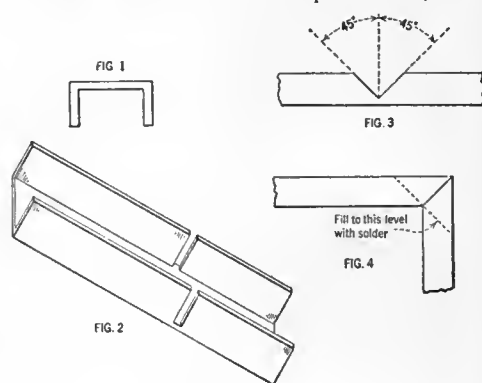

FIG. 8

3. Be sure the angle at the bottom of the notch is one of 90° and that it is pretty accurately placed 45° on each side of the perpendicular. The bracket is now bent, as shown in 4. If your angle is correct, the top piece will project from the panel exactly square, and the weight on the sub-panel will be supported nicely by the side walls of the notch as they come together.

Of course, by regulating the angle of the filed notch, you may make a bracket that projects from the panel at any angle of more or less than 90° as you wish. This idea could be used in making sets with a sloping panel.

To finish the bracket, fill the corner where the brass was bent, with solder. This prevents the bracket from bending back under pressure from beneath, such as is exerted when the foot on the sub-panel rests on a table or the bottom of the cabinet.

R. L. DOUGLAS,  
Huntington Park, California.

# ATWATER KENT RADIO

“Are you running a store  
or a museum?”

THAT'S what the caustic stranger said to the radio merchant.

The merchant started to flare up, but thought better of it. Instead, when the visitor departed he spent a profitable half-hour with his own thoughts.

Had he taken on too many lines? Had he selected them indiscriminately? Didn't unsalable reminders clutter his shelves? Obsolete models, discontinued by the manufacturer in the middle of the year? Orphan sets—maker gone out of business?

Those job lots he had bought to “move quickly”—weren't they still hanging around? Yes, and good sets, but without the necessary advertising to make people want them? And sets that looked good but ate their heads off in service calls? Sets that had come in with drums beating—and stayed while the parade passed on?

“It is a museum,” said the merchant. “I only *thought* it was a store.” Whereupon he cleared out the relics as best he could, concentrated on two lines his customers really wanted, and lived happily ever after.

\* \* \*

Has the Radio *you* handle commer-

cial value? Is it a good product, nationally advertised, and fairly priced? Has it a record of consistent sales and assurance of permanence? Does it sell easily—and *stay sold*, enabling you to turn your capital often with a minimum of overhead? In short, is it *profitable*—over a period of time?

If April is your month for mental stock taking—for figuring what you have been doing, where you stand and whither you are bound—isn't this a good time to look around, see what the Atwater Kent Radio merchants have done and what *they* think of the radio business?

Perhaps you would fit into the picture, too.

#### EVERY SUNDAY EVENING

The Atwater Kent Radio Hour brings you the stars of opera and concert, in Radio's finest program. Hear it at 9:15 Eastern Time, 8:15 Central Time, through:

WEAF . . . . . New York	WFI } . . . . . Philadelphia
WJAR . . . . . Providence	WOO } . . . . . alternating
WEEL . . . . . Boston	WCAE . . . . . Pittsburgh
WSAI . . . . . Cincinnati	WGR . . . . . Buffalo
WCAP . . . . . Washington	WOC . . . . . Davenport
WCCO . . . . . Minn.-St. Paul	WTAG . . . . . Worcester
WEAR . . . . . Cleveland	KSD . . . . . St. Louis
WLIB . . . . . Chicago	WWJ . . . . . Detroit

Write for illustrated booklet of Atwater Kent Radio.

ATWATER KENT MANUFACTURING CO.  
A. Atwater Kent, President  
4726 WISSAHICKON AVENUE, PHILADELPHIA, PA.



# Short-Wave Stations of the World

THIS list, containing more than a hundred short-wave stations situated throughout the world, is about the most completely accurate one yet to be printed. The Traffic Department of the Radio Corporation of America cooperated in its compilation. Included in this list are stations known to be operating on the wavelengths given, stations licensed for operation, and stations which have been in operation to any considerable extent during the past year, and which are not definitely discontinued.

## FROST-RADIO

### No. 530 Socket

for all new type tubes

The new No. 530 **FROST-RADIO** Socket takes ALL of the new type tubes. It is made from black polished Bakelite, and has sturdy contact springs which hold the tube prongs for almost their entire length. Price 40c at your nearest dealers.

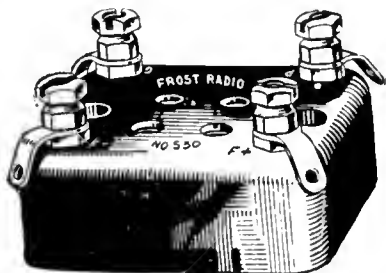

The No. 530 is a rich-looking socket because it is made from real Bakelite. Takes all the new type tubes. Price 40c

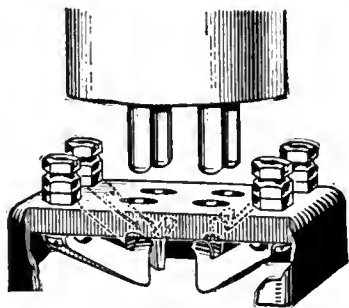

Note the spring construction as revealed by this cut-away view. These sturdy springs are held between cast bosses, and stay put.

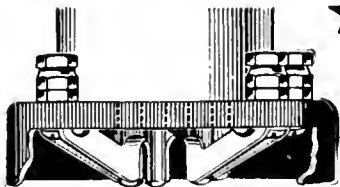

When the tube is inserted each prong is gripped the full length on two sides and held in a vice-like grip. Dirt cannot remain on the springs or prongs here.

**HERBERT H. FROST, Inc.**  
314-324 WEST SUPERIOR ST., CHICAGO  
New York City Cleveland Kansas City  
Los Angeles

Export Office: 314 W. Superior St., Chicago

### Blackburn Ground Clamps

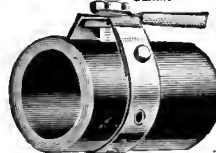

Telephone companies using MILLIONS. Adjustable—fits any size pipe. Requires no pipe cleaning—screw bores through rust and scale. Send 12 cents for sample and postage.

Blackburn Specialty Company  
1960 E. 66th St. Cleveland, O.

## Burns

### PERFECT REPRODUCER

Loud, Pleasing tone. Handsome material. Distinctive design.

Horns, \$22.50 to \$30.00  
Units, 10.00 to 12.00



**American Electric**

State & 64th Sts. COMPANY

Chicago

CALL SIGNAL	LOCATION	FREQUENCY IN KC.	WAVELENGTH METERS
POF	Nauen, Germany	22209	13.5
2XS	Rocky Point, New York	20082	14.93
2XAW	Schenectady, New York	19988	15
2BR	Chelmsford, England	19988	15
POF	Nauen, Germany	18738	16
NKF	Anacostia, District of Columbia	18738	16
2BR	Chelmsford, England	17636	17
POF	Nauen, Germany	16657	18
2XAD	Schenectady, New York	14991	20
KFVM	SS <i>Idalia</i>	14991	20
POF	Nauen, Germany	14991	20
NAL	Washington, District of Columbia	14991	20
NEPQ	USS <i>Relief</i>	14991	20
NKF	Anacostia, District of Columbia	14414	20.8
WIK	New Brunswick, New Jersey	13628	22
2YT	Poldhu, England	11993	25
POY	Nauen, Germany	11993	25
FW	Sainte Assise, France	11993	25
NKF	Anacostia, District of Columbia	11758	25.5
AGA	Nauen, Germany	11532	26
PCMM	Kootwijk, Holland	10903	27.5
POW	Nauen, Germany	10708	28
2XI	Schenectady, New York	9994	30
NAL	Washington, District of Columbia	9798	30.6
2YT	Poldhu, England	9369	32
ANE	Malabar, Java	9369	32
NAJ	Great Lakes, Illinois	8630	34
WQO	Rocky Point, New York	8560	35.03
PCMM	Kootwijk, Holland	8328	36
PCUU	Kootwijk, Holland	7890	38
KFVM	SS <i>Idalia</i>	7496	40
NAS	Pensacola, Florida	7496	40
NAJ	Great Lakes, Illinois	7496	40
NPG	San Francisco, California	7496	40
NRRL	USS <i>Seattle</i>	7496	40
NQW	USS <i>New Mexico</i>	7496	40
2XAC	Schenectady, New York	7496	40
NKF	Anacostia, District of Columbia	7260	41.3
2XAF	WGY—Schenectady	7160	41.88
5XH	New Orleans, Louisiana	7139	42
FW	Sainte Assise, France	7139	42
WIZ	New Brunswick, New Jersey	6970	43.02
WQO	Rocky Point, New York	6814	44
KZA	Los Angeles, California	6814	44
KZB	Los Angeles, California	6814	44
PCLL	Kootwijk, Holland	6518	46
WHD	Sharon, Pennsylvania	6119	49
NPM	Honolulu, Territory of Hawaii	6119	49
2XAD	Schenectady, New York	5996	50
SAJ	Karlsborg, Sweden	5996	50
WQN	Rocky Point, New York	5822	51.5
NPU	Tutuila, Samoa	5657	53
NBA	Balboa, Canal Zone	5552	54
NKF	Anacostia, District of Columbia	5511	54.4
WQN	Rocky Point, New York	5501	54.5
KFKX	Hastings, Nebraska	5354	56
ANF	Malabar, Java	5354	56
1XAO	Belfast, Maine	5354	56
WQN	Rocky Point, New York	5260	57
KDKA	East Pittsburg, Pennsylvania	5100	58.79
KDC	Casper, Wyoming	5082	59
2YT	Poldhu, England	4997	60
KDKA	East Pittsburg, Pennsylvania	4759	63
8XS	East Pittsburg, Pennsylvania	4475	67
NPO	Cavite, Philippine Islands	4409	68
WRB	Miami, Florida	4383	68.4
WRP	Miami, Florida	4383	68.4
2XAO	Belfast, Maine	4283	70
POX	Nauen, Germany	4283	70
NPO	Cavite, Philippine Islands	4283	70
NERM	USS <i>Los Angeles</i>	{ 4283	{ 70 to
		{ 35.18	{ 84.5
NQG	San Diego, California	4253	70.5
NKF	Anacostia, District of Columbia	4205	71.3
NPL	San Diego, California	4182	71.7
WIR	New Brunswick, New Jersey	4052	74
SFR	Paris, France	3998	75
NUQB	USS <i>Pope</i>	3998	75
NIRX	USS <i>Canopus</i>	3998	75
NAJ	Great Lakes, Illinois	3945	76
NFV	Quantico, Virginia	3874	77.4
JIAA	Iwatsuki, Japan	3795	79
KFVM	SS <i>Idalia</i>	3748	80
NEL	Lakehurst, New Jersey	3748	80
2XK	Schenectady, New York	3748	80
NPG	San Francisco, California	3701	81
NKF	Anacostia, District of Columbia	3679	81.5
RDW	Moscow, Russia	3612	83
NKF	Anacostia, District of Columbia	3569	84
SFR	Paris, France	3527	85
NQG	San Diego, California	3486	86
KIO	Kahuku, Territory of Hawaii	3331	90
2YT	Poldhu, England	3190	94
KEL	Bolinas, California	3156	95
8XS	East Pittsburg, Pennsylvania	3123	96
POX	Nauen, Germany	2998	100
NAM	Norfolk, Virginia	2998	100
WGH	Tuckerton, New Jersey	2911	103
WHU	SS <i>Big Bill</i>	2855	105
2XK	Schenectady, New York	2751	109
KFVT	SS <i>Eloise</i>	2726	110
KFHV	SS <i>Facile</i>	2726	110
KFWJ	SS <i>Gallant</i>	2726	110
1XAO	Belfast, Maine	2677	112
FL	Paris, France	2607	115
KFWK	SS <i>Nirvana</i>	2607	115
KFVB	SS <i>Bridget</i>	2600	115.3



# Cardwell

## Old Friends

*With New Faces*

are far more dependable than strangers.

The logical plate shape of a rotary variable condenser is semicircular, and to use these plates to the proper advantage, neither rotor nor stator should be cut away to any extent.

Cardwell Taper Plate Type "E" condensers have the old familiar plate shape, but have a straight frequency tuning characteristic.

Authorities agree that these condensers are the finest instruments ever produced. Mr. Arthur H. Lynch, Editor of "Radio Broadcast," selected them as ideal for use in the "Aristocrat" and other receivers. Mr. Gerald M. Best, Editor of "Radio," uses them in his new "Super."

The Type "C" approaches straight frequency at minimum but gives more separation at maximum.

They are priced the same—the .0005 mfd. capacity lists at \$5.00, and others, proportionately.

**The Allen D. Cardwell Mfg. Corp.**

81 PROSPECT STREET  
BROOKLYN, N. Y.

5c. in stamps brings this booklet on the Best Super-Heterodyne.

if your dealer can't supply you, order direct. Write for illustrated catalogue and handbook.

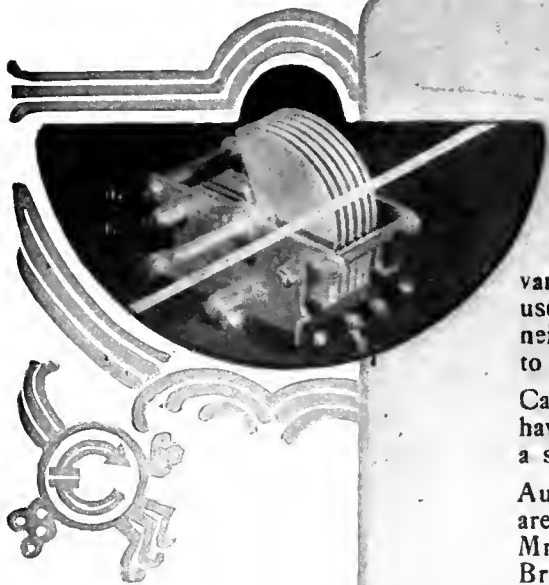

The Taper Plate Type "E" with straight frequency tuning characteristics

The Type "C" has a modified straight wave length tuning curve

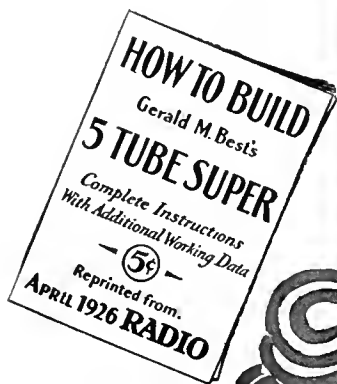

# Condensers

"THE STANDARD OF COMPARISON"

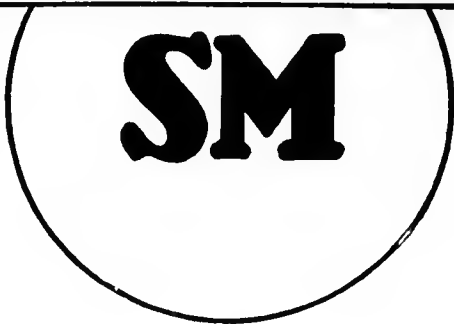

# PARTS

## THE S C RECEIVER

In this new, single control, all-wave, 4-tube receiver, designed by eight eminent, engineering staffs, SM PARTS were used wherever possible. Their unquestionable excellence and dependability made SM Parts the logical selection for this advanced receiver. That is why in almost every successful receiver design of past and present seasons you will find SM Products—depended upon, and dependable.

## THE "SIX"

Type 600 KIT Includes all parts necessary. . . . \$53.00  
 Type 610 KIT Essentials only, including 3 condensers, 3 inductances and 3 inductance sockets . . . . \$27.75

## SM THORDARSON B-ELIMINATOR

The SM Type 650 Kit includes Thordarson Transformer, Choke, Tube Condensers, genuine Ratheon Tube, Bradleyohms and all necessary parts . . . . . \$34  
 This Eliminator will deliver from 20 to 200 volts at three different adjustable voltages with maximum current of 50 milliamperes—more than enough for the largest receiver. Send for Assembly Instructions by McMurdo Silver . . . . . 10c

SEE SM PARTS AT YOUR DEALERS OR SEND FOR CIRCULARS

## Silver-Marshall, Inc.

103 S. Wabash Ave., Chicago

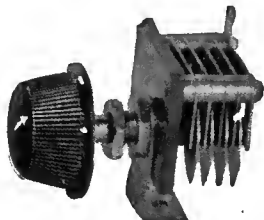

Type 340 Compensating Condenser, .000025 Mfd. with knob, \$1.50.



Type 510 All-Bakelite Socket for UX Tubes, 50c.

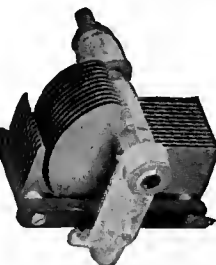

Type 316 Condenser, .00035 Mfd. for single or gang control. Brass plates, die cast frame. Price, \$5.75.



Type 801 Universal Vernier Dial, Ratio 14.5:1. Fits any standard condenser right or left, 180 or 360° movement. Price, \$2.50.

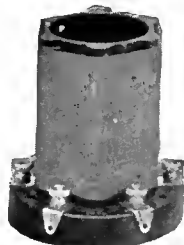

Interchangeable Coils for any wavelength. Standard Sizes. \$2.50. Type 515 Coil Socket, \$1.00.

## A KEY TO RECENT RADIO ARTICLES

By E. G. SHAULKHAUSER

THIS is the sixth installment of references to articles which have appeared recently in various radio periodicals. Each separate reference should be cut out and pasted on cards for filing, or pasted in a scrap book either alphabetically or numerically. An outline of the Dewey Decimal System (employed here) appeared in the November and January RADIO BROADCAST, and will be reprinted in an early number.



R113.4. IONIZATION; HEAVISIDE LAYER HEAVISIDE LAYER. Popular Radio, Jan. 1926, pp. 61-63. "Up and Down Movement of the Heaviside Layer," Dr. E. E. Free.

A short outline covering the research in high frequencies carried on at the Naval Research Laboratory by Dr. A. H. Taylor and Dr. E. O. Hulbert, is reported. Most of the phenomena observed are explained on the basis of the Heaviside Layer movements. Skipped distances and fading apparently depend upon the height of this layer and its position during day and night.

R382. INDUCTORS. INDUCTION COILS. Popular Radio, Jan. 1926, pp. 80-83. "Some Methods for Determining the Distributed Capacity of Coils," H. S. Knowles.

A discussion covering several methods which may be used in measuring the distributed capacity of coils, is presented. Mathematics and graphs are used in giving the information.

R382. INDUCTORS. INDUCTION COILS. RADIO BROADCAST, Feb. 1926, pp. 436-438. "Design of Radio Inductances," W. W. Harper.

Inductances, whose efficiency is high, must be designed to have a low high frequency resistance compared to inductance, twenty-five or more microhenries per ohm being considered a good coil in the opinion of the writer. Such a coil results in sharp tuning when combined with good condensers, although pick-up action of coils and crowding of apparatus in sets may make tuning broad. The standards of coil design are given as follows: (1) Low resistance over the broadcast frequency spectrum combined with as high a value of inductance as is permissible under the circuit conditions; (2) Effective confinement of electrostatic and electromagnetic field; (3) Consistent mechanical and electrical characteristics; (4) Small physical dimensions so as to permit compact construction. Experiments and tests have shown that space-wound solenoids are best for radio frequency purposes. With proper copper shielding and grooved space winding, the new so-called Metaloid coil was designed and built. Its L/R value is 320/9.5, equal to 33, as given in the data.

R343. ELECTRON TUBE RECEIVING SETS. RECEIVERS. RADIO BROADCAST, Feb. 1926, pp. 430-444. Grimes Reflex "How to Build a Grimes Inverse Duplex," F. J. Fox.

Constructional details of a four-tube Grimes Inverse Duplex receiver are given. The set is considered very sensitive and selective, and is easily built by the home constructor. Photographs, circuit diagrams, details of coil construction, panel layout, and method of locating audio, radio, or overload howl, which might be found in the completed receiver, give the necessary information desired when building such a receiver.

R800 (621-353) BATTERIES, PRIMARY. BATTERIES, Life of B. RADIO BROADCAST, Feb. 1926, pp. 452-455. "How Long Will My B Batteries Last?," G. C. Furness.

A discussion on the life of B batteries in all sets from one to eight tubes or more, leads the author to the conclusion that the life of B batteries depends entirely upon current drain and size of cells in the battery. Charts and figures are presented, verified experimentally, showing how a definite time limit of six, eight, or twelve months can be set on the average life of B batteries when these are chosen properly for the receiver in question.

R131. Characteristic Curves; General Properties. VACUUM TUBES. RADIO BROADCAST, Feb. 1926, pp. 456-461. Characteristics. "How to Use Vacuum Tubes," Keith Henney.

In this article, the elementary principles of vacuum tubes and their characteristics are discussed, a clear meaning of such terms as amplification constant, mutual conductance, plate impedance, of tube characteristics in general, etc; being included. Data covering a great many makes and varieties of tubes are presented. Circuit diagrams show how this information was obtained. The proper use of C batteries and correct amount of filament current, are essential in good tube operation, according to the author.

R620.068. TESTING. TESTS OF RADIO BROADCAST, Feb. 1926, pp. 462-464. BROADCASTING "The 1926 International Radio Broadcasting Tests," W. K. Wing.

An outline of the plans and the transmitting schedule for the 1926 International Radio Broadcasting Tests are given. Many foreign stations lent their full cooperation and support to the success of this undertaking sponsored by RADIO BROADCAST.

R210. FREQUENCY; WAVELENGTH. FREQUENCY TO WAVELENGTH. RADIO BROADCAST, Feb. 1926, pp. 471-472. WAVELENGTH. "Taking the Complexity Out of Wavelength-Frequency Conversion," H. S. Davis.

A simple full-page frequency-wavelength conversion chart is presented together with information on how to use it. The author emphasizes the fact that the term frequency and not wavelength is the proper term to use, and gives definite reasons.

Why not subscribe to *Radio Broadcast*? By the year only \$4.00; or two years, \$6.00, saving \$2.40. Send direct to Doubleday, Page & Company, Garden City, New York.

# For Better Radio Hammarlund PRECISION PRODUCTS

Write for Descriptive Literature

HAMMARLUND MANUFACTURING CO.  
 424-438 West 33rd Street New York City

## Join the Leaders at RADIO CENTER!

Radio Center is the big move of the year in radio. It provides sound-proof offices and demonstration rooms of special construction where radio manufacturers and distributors can enjoy year-round sales facilities of unusual attractiveness.

Radio Center occupies two floors of more than twenty thousand square feet in the famous Bush Buildings New York in the heart of the world's greatest radio market. This real opportunity demands action now. Don't delay—call in person at Radio Center or wire for space reservations.

### RADIO CENTER, Inc.

S. Herbert Mapes, President

Bush Building

130 W. 42nd St. New York City

22½ Volt un-acid everlasting rechargeable "B"

Storage Battery

\$2.95

includes chemical



45 volts \$5.25, 90 volts \$10.00, 112½ volts \$12.50, 135 volts \$14.75, 157½ volts \$16.80. Truly the biggest buy today. Easily charged on any current including 52 volt systems. Any special detector plate voltage had. Tested and approved by leading authorities such as Popular Radio Laboratories. Over 3 years sold on a non-red tape 30 day trial offer with complete refund if not thoroughly satisfied. Further guaranteed 2 years. Knock-down kits at greater savings. Complete "Hawley" "B" Battery Charger \$2.75. Sample cell 35c. Order direct—send no money—simply pay the expressman cost on delivery. Or write for my free literature, testimonials and guarantee. Same day shipments. B. Hawley Smith, 312 Washington Ave., Danbury, Conn.

# TRUTH

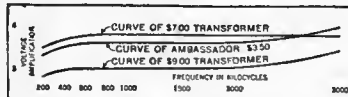

## AMBASSADOR Perfect Radio TRANSFORMERS

By the most careful laboratory tests give as good or better results than transformers costing two and three times as much. Test them in your set and be convinced of the TRUTH.

FREE Four page booklet in colors, "The Truth About Transformers" and hook-ups.

★  
AMBASSADOR SALES CO.  
110 Greenwich St., Dept. 451 New York



### These Instruments FREE of Extra Cost

All instruments shown here and others—SIX BIG OUTFITS—sent to all our students free of extra cost under short-time special offer. **Clip coupon now—** find out all about this big unequalled offer while you still have time to take advantage of it. Our training is intensely practical—these instruments help you learn to do the practical work. Receiving sets, from simplest kind to thousand-mile receiver. Many other big features.



J. E. SMITH, President

### My Radio Training is The Famous "Course That Pays For Itself"

Spare time earnings are easy in Radio when you know it the way we teach you. Increase your income almost from the start of your course through practical knowledge we give you. We show you how to hold the job, then our big Free Employment Department helps you get one. Free Book "Rich Rewards in Radio" tells how.

Howard B. Luce of Friedens, Pa., made \$320 in 7 weeks during his spare time. D. H. Suitt of Newport, Ark., writes, "While taking the course I earned in spare time work approximately \$900." Earl Wright of Omaha, reports making \$400 in a short time while taking his course—working at Radio in his spare time only! Sylvester Senso, 207 Elm Street, Kaukauna, Wis., made \$500.

And when your training is completed you're ready to step into a real big Radio job like C. C. Gielow, Chief Operator of the Great Lakes Radio Telegraph Company; E. W. Novy, Chief Operator of Station WRNY; Edward Stanko, Chief Operator of Station WGR; and hundreds of other N. R. I. trained men. The National Radio Institute, Originator of Radio Home-Study Training, established 1914, today offers you the same opportunity these men had, under a bond that guarantees you full satisfaction or money refunded. It's your big chance to get into Radio—mail coupon for FREE Book and proof!

**"MEN! Here's the 'dope' you've been looking for—**

**How TO GET INTO THE RADIO BUSINESS"**

J.E.S.

**\$50 to \$250 a Week in Work That is Almost Romance**

If you're earning a penny less than \$50 a week, clip coupon now for FREE BOOK! New book, profusely illustrated, tells all about the Radio Profession, thousands of openings—in work that is almost romance! YOU can learn quickly and easily at home, through our tested, improved methods, to take advantage of these great opportunities. Why go along at \$25 or \$35 or \$45 a week, when you can pleasantly and in short time learn to be a Radio Expert, capable of holding the big jobs—paying \$50 to \$250 a week?

### Clip Coupon For Free Book

Don't envy the other fellow who's pulling down the big cash! Our proven home-study training methods make it possible for you, too, to get ready for a better job, to earn enough money so you can enjoy all the good things of life. Most amazing book ever written on Radio tells how—thousand of interesting facts about this great field, and how we can prepare you, quickly and easily in your spare time at home, to step into a big-pay Radio job. You can do what thousands of others have done through our training. GET THIS NEW FREE BOOK. SEND COUPON TO-DAY.

V. E. SMITH, President

## NATIONAL RADIO INSTITUTE

Dept. DU-5 Washington, D. C.

**NOW! Special Short Time Offer**

**6 BIG OUTFITS**

**Radio Needs Trained Men**

Dept. DU-5 National Radio Institute Washington, D. C.

Dear Mr. Smith: Without obligating me in any way, send me your big FREE BOOK, "Rich Rewards in Radio," and all information about your practical, home-study, Radio Course.

**SEND THIS COUPON TODAY**

Name.....  
Address.....



## -it's in the Tube

A receiving set is no better than its tubes.

With other parts and connections *right* a set may be as good as its tubes—no set can be better.

That's why you want CECO Tubes. They stand up and deliver. With them your set works at its maximum. Clarity of tone, rich volume, long life—CECO has them all to a superlative degree.

Our charted tests (results confirmed by laboratories of national reputation) PROVE CECO TUBE SUPERIORITY—whether used as detectors, audio or radio frequency amplifiers.

CECO Tubes make a Good Receiver BETTER. Try them and you'll BUY them always—for results.

**Now Ready!** CECO Tubes with new type Long PRONG BASES. Also, Power Amplifier Tubes, E (Dry Cell Type), F (Storage Battery), for last stage of Audio Frequency.

Dealers write giving jobber's name.

C. E. Mfg. Co., Inc.

702 Eddy Street, Providence, R. I.



### RADIO PANELS OF GENUINE BAKELITE

Cut, drilled and engraved to order. Send rough sketch for estimate. Our New Catalog on Panels, Tubes and Rods—all of genuine Bakelite—mailed on request.

STARRETT MFG. CO. ★

521 S. Green Street

Chicago, Ill.

RADIO FANS, a one-year's subscription to Radio Broadcast will cost you four dollars, two years six dollars. Consider this expenditure as being a necessary investment on your part for the future development of your own knowledge of Radio.

### LEARN THE CODE AT HOME with the OMNIGRAPH

"Just Listen—The Omnigraph will do the teaching!"

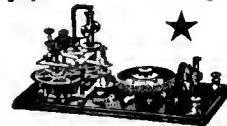

THE OMNIGRAPH Automatic Transmitter will teach you both the Wireless and Morse Codes—right in your own home—quickly, easily and inexpensively. Connected with Buzzer, Buzzer and Phone or to Sounder, it will send you unlimited messages, at any speed, from 5 to 50 words a minute.

THE OMNIGRAPH is not an experiment. For more than 15 years, it has been sold all over the world with a money-back guarantee. The OMNIGRAPH is used by several Depts. of the U. S. Govt.—in fact the Dept. of Commerce uses the OMNIGRAPH to test all applicants applying for a Radio license. The OMNIGRAPH has been successfully adopted by the leading Universities, Colleges and Radio Schools.

Send for FREE Catalogue describing three models. DO IT TO-DAY.

THE OMNIGRAPH MFG. CO., 13K Hudson St., New York City

If you own a Radio Phone set and don't know the code—you are missing most of the fun

★ Tested and approved by RADIO BROADCAST ★

#### R343. ELECTRON TUBE RECEIVING SETS. RECEIVERS.

"A New Reflex Circuit", L. W. Hatry. *Reflex*, *QST*, Jan. 1926, pp. 17-20.

A reflex circuit using good high primary-impedance audio transformers and proper bypass condensers, is described. Distortion is prevented also by reflexing through a radio frequency tube with a shunt rather than a series audio frequency connection. The method and circuit arrangement in a two- and three-tube set are discussed in some detail.

#### R344.3 TRANSMITTING SETS. TRANSMITTERS.

"Practical Crystal Controlled Transmitters", *Crystal Controlled*, *QST*, Jan. 1926, pp. 21-25.

A description of crystal controlled transmitters operating from a d.c. as well as a.c. source of supply is submitted. Complete constructional details of the crystal controlling station at 4 XE are given. It operates from a d.c. source using an UX-210 and three 203-A tubes. The a.c. crystal controlled set described operates with two UX-210 and two 203-A tubes. Method of mounting the crystals and certain precautions are necessary in handling them, according to the author.

#### R402. SHORT WAVES. SHORT-WAVE TRANSMITTERS.

"Getting Down Below Five Meters", H. Lyman. *QST*, Jan. 1926, p. 28.

Several circuit diagrams with constants of transmitters suitable for the very high frequency bands used by amateurs, are given.

#### R007. REGULATIONS. CONFERENCE.

"The Fourth National Radio Conference", K. B. Warner. *Fourth National*, *QST*, Jan. 1926, pp. 33-36.

A survey of the transactions and recommendations made by the various committees at the Fourth National Radio Conference, is given. Several changes in the allocation of frequencies were proposed, including amateur phone operation on the 3500-3600 kc band (85.7-83.3 meters). Broadcasting conditions are to be placed on a higher plane than heretofore, through elimination of some of the stations and adoption of new regulations governing their operation. The new frequency assignments from 550 kilocycles up (545 meters down) are also published in this summary.

#### R610. EQUIPMENT; STATION DESCRIPTION. STATIONS.

"The Radio Detective", *Portable*, *Radio*, Jan. 1926, pp. 10-11.

A car, completely equipped with necessary transmitter and receivers for use in connection with the radio supervisor's work in the 8th district, is described and illustrated. A Kolster direction finder, short- and long-wave receivers of various types, a 50-watt transmitter, and equipment for giving license examinations anywhere, make this portable radio station a modern radio supervisor's office on wheels. The diagram of the field strength measuring set is shown, and constants of the circuit given.

#### R343. ELECTRON TUBE RECEIVING SETS. RECEIVER.

"An Exceptional Four-Tube Receiver", E. E. Turner. *LC Modified*, *Radio*, Jan. 1926, pp. 12ff.

A four tube receiver, r. f. stage, regenerative detector, and two stages of audio amplification, is described. The wiring diagram shows several unique features, which are also taken up in the general discussion. Among these is the method of controlling oscillations in the regenerative circuit. Data on coil construction and panel layout, serve as a guide to building the set. An ABC eliminator may be used with the set, the wiring diagram of the complete circuit being shown. This set is a modification of the LC circuit described in the October, 1925, issue of *Radio*.

#### R531.2. STATION CALL LETTERS. STATIONS.

"Short-Wave Stations", *Short-wave*, *Radio*, Jan. 1926, p. 22.

A complete list of short-wave stations both, limited commercial and general public, operating in the United States, is given. There are forty-six in all. The inclusion of class, frequency, wavelength, owner, power, and call, makes this table a most complete reference guide.

#### R376.3 LOUD SPEAKING REPRODUCERS. LOUD SPEAKERS.

"Hornless Types of Loud Speakers", Dr. J. P. Minton. *Hornless*, *Radio*, Jan. 1926, pp. 24ff.

The author enters into a detailed discussion concerning the general types of loud speakers now used. The new cone type speakers make use of large vibrating surfaces. Flat surfaces may be used to obtain good sound vibrations over a large frequency range, but shaping such surfaces into the form of a cone gives greater rigidity and less natural resonance, at the same time rendering also better acoustic radiation. Three types of driving units have been employed in the commercial cone speakers; electro-dynamic, balanced armature, and bipolar unit. These are discussed in detail.

#### R383. RESISTORS. RESISTORS.

"Vacuum Tube Resistors", G. F. Lampkin. *Vacuum Tube*, *Radio*, Jan. 1926, pp. 25ff.

Vacuum tubes, in addition to being used as detectors, amplifiers, and oscillators, may be used as variable resistors to very good advantage. As such they have several advantages not found in grid leaks or regular resistances. They are especially good as a grid leak in an oscillator to control keying and phone transmission. Data on actual tests made with 201-A and 202 tubes, and information concerning their uses as grid leak resistors, are given.

#### R148. MODULATION. MODULATION.

"Speech Modulation Methods", Lieut. J. B. Dow. *Methods*, *Radio*, Jan. 1926, pp. 31-32.

Three methods of speech modulation, the variable absorption method, grid voltage variation method, and the plate power variation method, are taken up. Several circuits, including the Meissner and a combination Heissing and Colpitts, are shown, and an account of their performances discussed in some detail.

#### R343. ELECTRON TUBE RECEIVING SETS. RECEIVERS.

"A Good Short-Wave Receiver", F. C. Jones. *Short-Wave*, *Radio*, Jan. 1926, p. 33.

For use on the very high frequency stations, a receiver must be capable of sharp yet not too sensitive tuning. Herein is described a two-tube receiver operating on the capacity feedback principle, the tube capacity being large enough for this purpose. Oscillations are controlled by means of a tuned-plate circuit. Constructional data and circuit diagram are given.

**R343. ELECTRON TUBE RECEIVING SETS. RECEIVERS, REFLEX.**  
*Radio*, Jan. 1926, pp. 29ff.  
 "Proper Reflex Circuit Assembly," L. W. Hatry.  
 Some very good points on the construction of a three-tube reflex receiver are contained in this article. The use of condensers and choke coils, and valuable suggestions pertaining to the circuit layout, accompany the article.

**R553. METEOROLOGICAL SIGNALS. EARTHQUAKE RECORDING.**  
*Radio*, Jan. 1926, pp. 35ff.  
 "Radio as an Aid in Recording Earthquakes," G. M. Best.  
 An account is given of a method of recording earthquake tremors automatically and accurately. Both the horizontal and vertical components of such tremors can be recorded, the exact time of such tremors being received from some naval time-signalling station and recorded on the same chart. A circuit diagram of the apparatus is shown.

**R800 (533). SOUND. PHONOGRAPH REPRODUCTION.**  
*Popular Radio*, Jan. 1926, pp 3-9.  
 "The New Wave-Transmission Phonograph," H. C. Harrison.  
 Principles developed in the mechanical reproduction of sound by Bell Telephone engineers, have been applied to the phonograph, with the result that now five and one-half octaves are faithfully reproduced instead of three, as was the case in the old type of phonograph, according to the article. The construction of the new reproducer is described and shown in a diagram. Comparison is made between electrical and mechanical constants, the similarity being very evident.

**R343. ELECTRON TUBE RECEIVING SETS. RECEIVER, LC-26.**  
*Popular Radio*, Jan. 1926, pp. 10-23.  
 "How to Get the Most out of Your LC-26 Set," S. G. Taylor and L. M. Cockaday.  
 Information is given concerning the theory and operation of the LC-26 receiver described in the December issue of *Popular Radio*. Details pertaining to antenna and ground connection, tubes and batteries to be used, installation, equipment, and operation of the receiver, are given. A shunt-plate feed unit, which keeps the d. c. out of the loud speaker, is a feature of this circuit.

**R800 (530) PHYSICS. ATOM.**  
*Popular Radio*, Jan. 1926, pp.24-29  
 "The Atom," Sir William Bragg.  
 The place that the separate atoms take in forming crystals, is outlined. Most substances crystallize in very orderly and regular fashion. X-Rays are used in analyzing transparent solids of crystalline structure to determine their arrangement. Examples and illustrations are given to show how atoms may arrange themselves and how X-Rays detect this arrangement.

**R382. INDUCTORS. INDUCTION COILS.**  
*Popular Radio*, Jan. 1926, pp. 30-39.  
 "Some New and Useful Facts about Coils," D. R. Clemons.  
 A discussion pertaining to distributed capacity of induction coils, employing various types of windings and materials for mountings, is given. The distribution and strength of the fields of magnetic and electrostatic forces, depending upon the kind of insulation used about the wire, is illustrated by means of graphs and diagrams. A lot of experimental data is given.

**R381. CONDENSERS. CONDENSERS FOR TUNING.**  
*Popular Radio*, Jan. 1926, pp. 48-55.  
 "The Part That Your Condenser Plays in Tuning," H. J. Harries.  
 Condensers of the circular plate, the square-law plate, and the straight line frequency plate, are compared. The effect each one of these condensers has on sharpness or broadness of tuning covering the present broadcast band, is shown by curves, data, and discussion. A low minimum condenser is really not what is desired in the opinion of the writer, but rather a condenser having a low resistance path at high frequencies.

**R380. PARTS OF CIRCUITS; INSTRUMENTS. TONE METER.**  
*QST*, Jan. 1926, pp. 37-39.  
 "The Tone Meter," L. J. Wolf.  
 A device indicating the condition of the plate supply current of vacuum tube transmitters, is described. Any source other than a high voltage storage battery will give a more or less fluctuating power supply which necessitates filtering. An a.c. voltmeter is used in series with a condenser, the condenser preventing the d. c. from getting through the meter and acting also as a multiplier. The multiplying factor depends on the frequency, the capacity of the condenser, and the resistance of the voltmeter. Its value can be determined, as described. The entire arrangement is called a Tone Meter.

**R375. DETECTORS AND RECTIFIERS. RECTIFIER, EPOM.**  
*QST*, Jan. 1926, pp. 41ff.  
 "The Epom Rectifier and Filter," R. S. Kruse.  
 The new Epom rectifier tube uses no filament but operates on the principle of ionization of a gas at low pressures within the tube. Argon gas is used for several reasons. The construction of the tube, and the circuit diagram are described. The tube may be used as a d. c. source of plate supply in transmitting tubes if properly loaded.

**R281.71. QUARTZ. QUARTZ CRYSTAL CONTROL.**  
*Radio News*, Jan. 1926, pp. 952 ff.  
 "Quartz Crystals Control Wavelengths of Broadcasting Stations," S. R. Winters and I. F. Byrnes.  
 The use of quartz crystals in the control of frequencies in broadcasting stations is growing, as is evidenced by the decision of the Westinghouse Company, and the General Electric Company, i. e., to equip all of their stations with this piezoelectric mineral, according to the authors. Its properties, operation in circuits, the use of harmonics produced by such an oscillating crystal, methods of mounting, and results obtained by the Navy and others, indicate that the quartz crystal will be in general use among transmitting stations before long.

**R402. SHORT-WAVE SYSTEMS. HIGH FREQUENCY SYSTEMS.**  
*Radio News*, Jan. 1926, pp. 954ff.  
 "Navy Investigates Ultra Frequencies," Dr. A. Hoyt Taylor.  
 The investigation carried on by the Naval Research Laboratory with ultra frequencies is presented in graphic and systematic form. Night and day range, comparison of phenomena at various frequencies, and directional effects, show that certain bands of frequencies should be chosen for definite transmission schedules depending upon time, distance, and season.



# INSULINE

No matter what circuit you are building, the final results will be better if you select Insuline for the panel—the material chosen by Radio Broadcast Engineers for the "Universal."

Laboratory tests prove Insuline to be highest in dielectric strength and other properties conducive to clear reception. Also the most easily worked panel material. Doesn't chip or crack. Doesn't warp. Holds its lustre for all time.

Insuline Panel for the "Universal," engraved by our exclusive Etch-O-Gravure Method, in gold and white or combination; drilled ready to set up: black or mahogany \$3.50; "Frieze" finish, \$4.00.

Insuline panels, drilled and decorated, are furnished for all popular circuits. Also supplied in all standard size blanks. Insuline Sub-panels, drilled and mounted with metal sockets for UV and UX tubes for all circuits. Bakelite Brackets for sub-panel mounting, etc., etc.

★ *If your dealer can't supply you write us direct. Send to-day for Free Booklet and price list.*

The best panel for Radio Broadcast's "Universal"—the best panel for YOUR set



"Sets that Jack and Dad Built," a practical 50-page book for building the most popular circuits, with diagrams and instructions for hook-up, sent for 25 cents to cover cost of mailing and postage.



Branches in Principal Cities

## INSULATING COMPANY OF AMERICA INC.

(RADIO PANEL & PARTS CORP.)  
 INSULINE BLDG., 59 WARREN STREET  
 NEW YORK

Why not subscribe to *Radio Broadcast*? By the year only \$4.00; or two years \$6.00, saving \$2.40. Send direct to Doubleday, Page & Company, Garden City, New York.

# LEARN RADIO

Become a big-pay man in the greatest industry of all time. Quickly, easily and right at home, you can fit yourself for highest salary positions, or you can cash in on your spare time. The call is urgent for mechanics, operators, designers, inspectors. Unlimited, fascinating opportunities on land or sea

**I WILL TRAIN YOU AT HOME TO BE A RADIO EXPERT**

Under my practical, easy to understand, instruction—you qualify in an amazingly short time. No previous experience is necessary. Every branch of radio becomes an open book to you. You learn how to design, construct, operate, repair, maintain and sell all forms of Radio apparatus. My methods are the latest and most modern in existence.

**FREE** Wonderful home construction tube receiving set of the latest design **Write Today** "Radio Facts" **FREE**

A. G. Mohsupt, Radio Engineer, RADIO ASSOCIATION OF AMERICA, Dept. 2484, 4513 Ravenswood Ave., Chicago

# every reader of this magazine needs

## G.I. Static Reductor

TRADE MARK



Practically eliminates normal static—reduces excessive static to a minimum. Eliminates necessity of outside aerial with any set—makes a squealing receiver absolutely non-radiating—increases selectivity—improves tone quality.

Elevates an inexpensive receiving set to the dignity and quality of a high-priced receiver.

Enables a good set to bring in far-distant stations with a full, clear, smooth tone not before dreamed possible.

Ask your dealer—or send purchase price direct and you will be supplied.

Price, \$28.50.

### GENERAL INSTRUMENT CORPORATION

423 Broome St., New York City

Order your copy of *Radio Broadcast* from your news dealer or radio store. Make sure that he reserves a copy for you each month. If your favorite radio store does not stock the magazine write us giving name of radio dealer and address.

## Send for Latest RADIO CATALOG and GUIDE

**Sets—Parts—Kits Radio's Newest**

You need this big FREE book. A practical guide to success in set building. Gives advanced hook-ups. Shows all newest parts and kits, built up sets ready for use, battery eliminators, radio's newest creations. Write for Copy free, also send name of radio fan. Send to-day.

**BARAWIK CO.**  
102-109 S. Canal St., Chicago

*The LATEST HOOK-UPS & RADIO Catalog*

**R113. TRANSMISSION PHENOMENA. FADING AND DISTORTION.**  
*Radio News*, Jan. 1926, pp. 956 ff.  
"Unraveling a Broadcast Enigma", A. Van A. Summers.  
Many data on fading and distortion of signals from broadcasting stations, which were accumulated by the American T. & T. Company, are presented. Conclusions arrived at indicate that the ether is not a perfect carrier of electromagnetic waves, especially when these waves are near large masses of iron and steel. Refraction and absorption are probably the causes for most of the distortion observed. The author discusses at some length the conclusions arrived at through these experiments.

**R114. STRAYS. AURORA BOREALIS.**  
*Radio News*, Jan. 1926, pp. 964 ff.  
"New Facts About the Aurora Borealis", C. L. Davis.  
An experiment relating the effect of the Aurora Borealis on a telephone line, and the subsequent conclusions drawn from this phenomenon, are described. A frequency of one cycle for fifteen minutes was noted on a voltmeter.

**R110. RADIO WAVES. RADIO WAVES.**  
*Radio News*, Jan. 1926, pp. 966 ff.  
"What Are Radio Waves?", J. Riley.  
An elementary explanation of the nature of radio waves, is given. Stress and strain, displacement of fields, electrostatic and electro-magnetic fields of force, questions on radiation, current and voltage relations in antennae, are some of the subject: discussed.

**R134.45. SUPER REGENERATIVE ACTION. SUPER-REGENERATIVE ACTION.**  
*Radio News*, Jan. 1926, pp. 976 ff.  
"Super Regeneration and the Future", A. K. Laing.  
The original Armstrong super regenerative circuit, modified somewhat, is presented, with points on construction and operation given. These, it is claimed, will make this type of amplification as popular as the super-heterodyne. The drawbacks of the circuit are enumerated and taken up in detail. The circuit is said to give much more amplification on the higher frequencies than on the low ones.

**R134.75. SUPER-HETERODYNE. SUPER-HETERODYNE.**  
*Radio News*, Jan. 1926, pp. 982 ff.  
"An Improved Laboratory Super-Heterodyne", F. R. Pfaff.  
A seven-tube super-heterodyne covering the frequencies from 550kc. to 5000kc. (550 to 50 meters) using plug-in coils, is described. The oscillator is connected ahead of the first detector in this circuit. Complete constructional data are given.

**R382. INDUCTORS. INDUCTION COILS.**  
*Radio News*, Jan. 1926, pp. 986 ff.  
"Which Type of Coil is Best?"  
An exhaustive study of various types of coils, dealing with their overall efficiency, is presented. Circuits used in the measurement of resistance at high frequencies, graphs showing the efficiency and distributed capacity of coils and the result obtained through experimental hookups, are discussed. The best all around coil, according to the writer, consists of ordinary bell wire wound on a bakelite tube in the regular fashion.

**R201.7 USE OF HIGH-FREQUENCY OSCILLOGRAPH. TUBES, OSCILLOGRAPH.**  
*Radio News*, Jan. 1926, pp. 988 ff. W.E.  
"The Cathode Ray Oscillograph In Radio Work", Dr. C. B. Bazzoni.  
The author reviews the elementary principles concerning electric waves and their forms, referring to pitch and quality of sound as an analogy. To study these wave forms, the cathode ray tube, illustrated, is of great importance in high frequency circuits. The tube used here was developed by the Western Electric Company. Electric and magnetic deflections of the electron stream through plates and coils near these electrons, picture the resulting wave forms for closer analysis. Lissajou figures produced, enable the experimenter to synchronize circuits or adjust them to many different ratios of oscillations.

**R343. ELECTRON TUBE RECEIVING SETS. RECEIVERS. Dereznadnyne.**  
*Radio Progress*, Dec. 15, 1925, pp. 13ff.  
"Revamping a Popular Radio", H. J. Marx.  
An analysis of the five-tube Dereznadnyne receiver is given, showing the wiring diagram and method of operation. This receiver is equipped with a B-eliminator, and trickle charger for the A battery; the speaker is built in the cover, thus making this set complete. Oscillations are prevented in the tuned radio frequency stages by controlling the plate voltage on the tubes through a series resistance. The coil angle may also be varied, depending upon the type and characteristic of the tubes used. Other details of operation are mentioned.

**R342.7. AUDIO-FREQUENCY AMPLIFIERS. AMPLIFICATION. RADIO BROADCAST.** Jan. 1926, pp. 308-312. *Audio Frequency.*  
"The Requirements for Better Audio Amplification," K. Clough.  
An analysis of the various instruments used in sound production show that a good amplifying device should respond equally well to frequencies from 32 to 8192 cycles or more. A full logarithmic scale is considered best in plotting characteristics of amplifying units. Of considerable importance are the characteristics of the tubes used in audio amplifiers, and good results are obtained only when the entire amplifying unit is tested as one device. It is stated that in the present type of resistance-coupled units, the lower notes are somewhat suppressed. Transformers having a cruciform core construction seem to give best results. Reference is made to Mr. Crom's article on audio amplification in the Oct., 1925, *RADIO BROADCAST*.

**R342.6. RADIO-FREQUENCY AMPLIFIERS. R. F. AMPLIFIERS. RADIO BROADCAST.** Jan. 1926, pp. 350ff. *Oscillations in.*  
"Methods for Controlling Oscillation in R. F. Circuits," J. Bernard.  
Many methods are used in r. f. amplifiers to prevent tubes from oscillating or to control oscillations. Some of these are discussed briefly by the author. A somewhat novel method is employed in the "Counterphase" circuit, diagrammed and described here. This scheme makes use of a combined resistance and capacity control, and is considered very effective over the entire range of frequencies to which the receiver is tuned.

## FOR CLEAR, QUIET "B" POWER



## RADIO Storage "B" Battery

**12 Cells 24 Volts Lasts Indefinitely—Pays for Itself**  
Economy and performance unheard of before. Recharged at a negligible cost. Delivers unfailing power that is clear, pure and quiet. Approved and listed as Standard by leading Radio Authorities, including Pop. Radio Laboratories, Pop. Sci. Inst. Standards, Radio News Lab., Lefax, Inc., and other important institutions. Equipped with Solid Rubber Case, an invariable aniline acid and leakage. Extra heavy glass jars. Heavy rugged plates. Order yours today!  
**SEND NO MONEY** Just state number of batteries wanted and we will ship day order is received. Extra offer: 4 batteries in series (96 volts), \$10.50. Pay exp. salesman after examining batteries. 5 per cent discount for cash with order. Mail your order now!

**WORLD BATTERY COMPANY**  
1219 So. Wabash Ave., Dept. 78 Chicago, Ill.  
Makers of the Famous World Radio "B" Storage Battery.  
Prices: 6-volt, 100 Amp. \$11.25; 120 Amp. \$13.25; 140 Amp. \$16.00. All equipped with Solid Rubber Case.

**World STORAGE BATTERIES**

Set your Radio Dials at 210 meters for the new 1000 watt World Storage Battery Station, WSB, Chicago. Watch for announcements.

KDKA - WEAZ - WGN - WJZ - KHJ - RGO - KFJ - WVA

## MRC Station and Meter Log

Now you can easily calibrate your dials in meters.

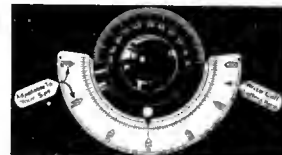

A convenient station log and wavelength scale — Very simple to attach and is a permanent log.

**SOLD BY MAIL ONLY**  
PRICES—1 for 15c, 2 for 25c or 3 for 35c.

**MUELLER RADIO COMPANY**  
533 Bush St. Toledo, Ohio

**S-C PARTS AT WHOLE-SALE PRICES**

Dealer-Set Builders and Radio Parts Dealers write for FREE description, list of parts and wholesale prices for Silver-Cockaday Single Control 4-Tube Receiver. Catalogue of nationally known radio equipment sent free. Write today. Address Dept. S

**SHURE RADIO CO., 19 S. Wells, Chicago**

**Gets Everything but Noise!**

Amazing new Aerial guaranteed to eliminate all power noises such as leaky transformers, generators, motor hums, Delco Plants, etc. Cuts static, regeneration howls and squeals 1-2. Dr. Gehrig, Oakland, Cal., says improves reception 80%. Hundreds of other testimonials. Wonderful results. Mr. Enoch Grand Haven, Mich., heard 3 foreign stations during tests with Kane Antenna. Easy to install.

**FREE BLUE PRINT—Working Drawings—\$1.00 Complete Instructions for Erecting.** Just send dollar bill (or check), 1 unit's quantity. Send TODAY. **KANE ANTENNAE CO., Dept. S-2 3313 W. Monroe, Chicago**

This is a good time to subscribe for  
**RADIO BROADCAST**  
Through your dealer or direct, by the year only \$4.00  
**DOUBLEDAY, PAGE & CO. GARDEN CITY, NEW YORK**

**Be the Jazz King Of Your Town!**

Be popular. In demand everywhere. Have fun Earn your welcome. Charm your friends with your

**BUESCHER True Tone**

**SAXOPHONE**

Teach yourself, 3 free lessons give you quick easy start. Try any instrument in your own home 6 days free. See what you can do. Easy terms if you decide to buy. Send now for beautiful free literature. A postal brings details.

**Buescher Band Instrument Co. (1)**  
1221 Buescher Block Elkhart, Indiana

**CORBETT CONSOLE**  
for Hammarlund Roberts



Five ply mahogany or walnut, with our usual high quality hand rubbed Duo-tone lacquer and varnish finish. Straight or sloping panel front.

The "Corbett Console" is adapted to any of the popular receivers, including LC-26, and Broadcast Universals.

WITHOUT HORN (as illustrated) \$40.00  
WITH BUILT IN HORN (Large Miller hard rubber horn at left of panel with silk backed grill). Shipping charges prepaid. . . . . 54.00

WRITE FOR BOOKLET showing attractive models for all sizes of radio cabinets consoles and tables.

Jobbers and Dealers write for discounts

CORBETT CABINET MFG. COMPANY  
St. Marys Pennsylvania

**LATEST "COAST TO COAST" FULLY GUARANTEED**

**RADIO'S-10 DAYS FREE TRIAL**  
SAVE 1/3 to 1/2

Users everywhere report: Miraco Radios get programs coast to coast on loud speaker; outperform sets three times as costly. Many hear foreign countries. Radio's most amazing values in unconditionally guaranteed, factory-built long distance sets—let testimony of users convince you.



**MIRACO RADIO GETS 'EM COAST & COAST**

Powerful New Multi-tube Miraco gets long distance on loud speaker. Set, ONLY \$27.35 retail

FREE! Literature on latest improved 1 to 5 tube models, new low prices, testimony of users and SPECIAL OFFER. Write: **MIDWEST RADIO CORP'N** Pioneer Builders of Sets 406-W E. 8th St. Cincinnati, O.

AGENT USERS WANTED Write for discounts.

RADIO FANS, a one-year's subscription to Radio Broadcast will cost you four dollars, two years six dollars. Consider this expenditure as being a necessary investment on your part for the future development of your own knowledge of Radio.



**LOW LOSS Tuners and Coils for all circuits**

3 Circuit Amateur and Broadcast tuners . . . . . \$7.00  
Tuned R. F. Transformers (each) . . . . . \$2.00

**NEW COILS**

Diamond of the Air  
Browning Drums Coils . . . . . \$7.00  
Superdyne Coils . . . . . 7.00  
Roberts Coils . . . . . 7.00  
Superheterodyne Oscillator and Antenna Coupler . . . . . 6.00

Basket Weave coils to order. Write for literature.  
Davenport Radio Laboratories 1711 W. Locust Street, Davenport, Iowa

**Big FREE RADIO**  
PARTS, Catalog & Guide  
HOOK-UPS, SETS and KITS

Send now for this valuable FREE book. Full of advanced hook-ups, parts and kits. A real guide. Shows factory built sets and the new ideas in radio. Send at once. No charge. No obligation. Please include name of radio fan.

**BARAWIK CO.**  
102-109 S. Canal St., Chicago

**"The Better Condenser"**

Maintains its Leadership



**RAYTHEON MANUFACTURING COMPANY**  
(Formerly AMERICAN APPLIANCE COMPANY)  
292 MAIN STREET  
CAMBRIDGE, MASS.

January 22, 1926

Tobe Deutschmann Company  
46 Cornhill  
Boston, Massachusetts  
Gentlemen:

Our laboratory has made thorough tests on the filter circuit condensers manufactured by your company for use in the Raytheon B-eliminator circuit. These tests have been entirely satisfactory and we do not hesitate to recommend your condensers to customers as being unsurpassed by any which are now being marketed for this purpose.

May we take this opportunity of commending you for your outstanding work in the merchandising of high-quality condensers for use in improved Raytheon plate supply units.

Very truly yours  
RAYTHEON MANUFACTURING COMPANY  
By Miles Penzabaker  
Sales Engineer

MP:KH

**Make sure that you get the OFFICIALLY APPROVED RAYTHEON Filter Condenser Block**

The TOBE Condensers have been tested in the laboratory of the Raytheon Manufacturing Company and as a result, they have written the letter reproduced above. It speaks for itself.

The new TOBE B BLOCK contains in one compact silvered metal case the three filter and two bypass condensers required for the Raytheon B-Eliminator; one 8 Mfd., two 2 Mfd., two 1 Mfd. It saves \$2.50 in the cost of parts—saves space—saves wiring.

Price \$11.00

Ask your dealer for "The Better Condensers."  
Send for free circuit diagrams of B-Eliminators.



**Tobe Deutschmann Co.**  
CORNHILL BOSTON, MASS.

This is a good time to subscribe for

**RADIO BROADCAST**

Through your dealer or direct, by the year only \$4.00

Doubleday, Page & Company

Garden City, New York



**Radio Battery Chargers**

Best by Test ★

**\$ 8.50** minus bulb

east of Rockies

Your dealer can get it for you

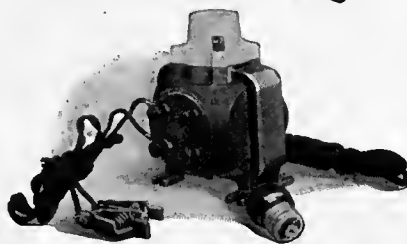

**THE ACME ELECTRIC & MFG. CO.**  
1410 Hamilton Avenue Cleveland, O.

# Modernize Your Radio Set!

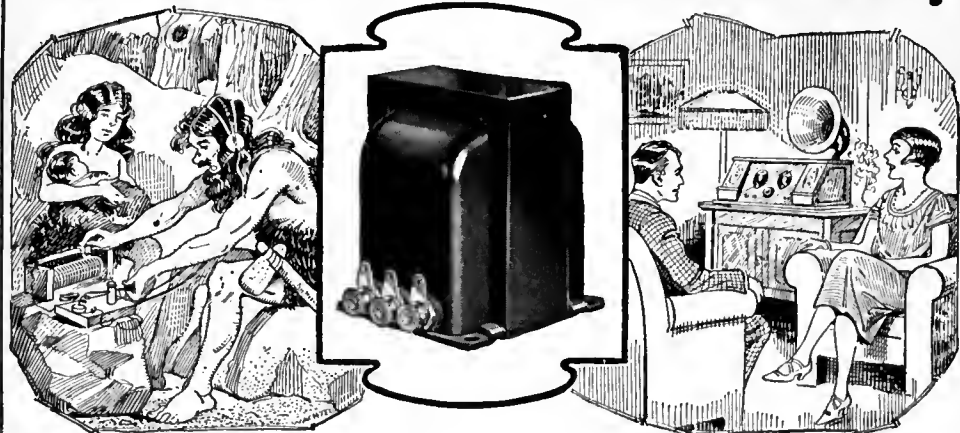

## THORDARSON Autoformer

Trade-Mark Registered

All Frequency Amplifier

Write for free  
descriptive circular

Price \$5.00

Are you still using primitive methods of amplification? Why not make your receiver an up-to-date model by installing Autoformer amplification—the ultimate in reproductive equipment?

The Autoformer, a step up impedance amplifier, reproduces with full volume those bass notes lost in ordinary transformer amplifiers.

The Autoformer provides the unrestrained flow of distortionless music. It records everything from the slightest shading to the greatest extreme of volume, intensity, and timbre.

Better volume control  
More volume on distant stations  
Full bass note amplification  
Greater clarity on all signals



### OTHER THORDARSON TRANSFORMERS

R-200 Amplifying Transformer  
Standard Amplifying Transformer  
Power Amplifying Transformer  
Interstage Power Transformer

B-Eliminator Transformer  
B-Eliminator Chokes  
Battery Charging Transformers  
Transmission Equipment

**THORDARSON ELECTRIC MANUFACTURING CO.**  
*Transformer Specialists since 1895*  
**WORLD'S OLDEST AND LARGEST EXCLUSIVE TRANSFORMER MAKERS**  
**Chicago, U.S.A.**

Now is the time to subscribe for **RADIO BROADCAST**  
Through your dealer or direct, by the year only \$4.00

DOUBLEDAY, PAGE & CO.

GARDEN CITY, NEW YORK

*Immediate Shipment from Stock*  
**HAVE MERCHANDISE  
WHEN YOU NEED IT**  
*Catalog 466-B is free to dealers*

WHOLESALE

EXCLUSIVELY

**LUDWIG HOMMEL & CO**

929 PENN AVENUE



PITTSBURGH, PA.

## WHAT OUR READERS WRITE



### The International Tests

AS MIGHT be expected, we were simply inundated with letters from all quarters of the country and abroad, after the recently concluded International Tests. Space limitations permit the publication of only three or four here, but these convey the sentiment expressed in the letters of many other correspondents.

Editor, RADIO BROADCAST,  
Doubleday, Page & Company,  
Garden City, New York.

SIR:

I hear over KGO's news items that California was silent during the test period. I wish to refute this statement for I distinctly heard KNX, Hollywood, on two different occasions while trying for British stations. . . . I think KNJ was on the air too, for I heard a station at a setting on my dials where this station usually comes in, but I could not be positive about this. There is nothing too small for California to do.

Very truly yours,  
F. W. DALLEY,  
Lyons, Colorado.

Editor, RADIO BROADCAST,  
Doubleday, Page & Company,  
Garden City, New York.

SIR:

Just a line in appreciation of last week's silence tests, especially those of Friday and Saturday evenings. Is it possible to have an arrangement for regular zonal silence periods, thus allowing uninterrupted sectional exchanges of programs? Here is one unsolicited vote in favor of such a scheme.

Very truly yours,  
R. M. BOULDEN,  
Los Angeles, California.

Editor, RADIO BROADCAST,  
Doubleday, Page & Company,  
Garden City, New York.

SIR:

Organize an anti-bloop club with a big turnout at first meeting. What are the other cities doing along this line?

Very truly yours,  
E. M. RAY,  
Rochester, Minnesota.

Editor, RADIO BROADCAST,  
Doubleday, Page & Company,  
Garden City, New York.

SIR:

I am a regular reader of your excellent magazine, and am also a confirmed radio fan, being interested in the reception of both broadcast matter and code. I was greatly interested in the International Tests, although they were a failure as far as I am concerned. In 1924, I received British stations with a modified three-tube Reinartz set. This year, nothing but interference, static, bloopers, and almost everything injurious to satisfactory radio reception. One thing that has come to my attention is that during the period from half-moon until the moon begins to wane, radio reception is not what it should be—it is noisy. At other periods, when there is no moon, reception is much better, I have found. During Test Week, the moon was pretty well full. I have been watching this phenomenon since last July. I wonder if any one else has noticed it. Wishing you continued



# AMPLION

*For Better Radio Reproduction*



**Hear this  
World-Wide  
Favorite**

Creation of Alfred Graham & Co., England, 38 years experienced in producing loud speaking devices, Amplions lead in sales throughout the world. Hear an Amplion—in comparison! Six models, including phonograph units, equipped with cords and plugs, \$12 up. Write for "Amplion Pedigree."

**THE AMPLION CORPORATION  
OF AMERICA**

Suite L, 230 Madison Avenue, New York  
Chicago Branch: 27-29 No. Morgan St.  
Burndep of Canada, Ltd., Toronto

# New! Tone and Volume Control



**ESSENTIAL** to thoroughly enjoy present day broadcasting. New high-priced sets feature tone control as their greatest improvement. You can have this new feature in your old set by attaching a *Centralab Modulator Plug* in place of the old phone plug. Takes a moment—no tools required.

Gives any degree of tone volume from a whisper to maximum by simply turning the small knob on plug. Static interference is reduced and programs come in clear and true with just the volume you most enjoy.

*Order from your dealer, or mailed direct on receipt of the price \$2.50.*

**CENTRAL RADIO LABORATORIES**  
22 Keefe Ave. Milwaukee, Wisconsin

*Centralab Radiohms or Modulators are standard controls on sixty-six well-known sets.*

## Send for Latest RADIO CATALOG and GUIDE

**Sets—Parts—Kits  
Radio's Newest**



You need this big FREE book. A practical guide to success in set building. Gives advanced hook-ups. Shows all newest parts and kits, built up sets ready for use, battery eliminators, radio's newest creations. Write for Copy free, also send name of radio fan. Send to-day.

**BARAWIK CO.**  
102-109 S. Canal St., Chicago

# Centralab

CRL

## Hoyt Pocket Meters

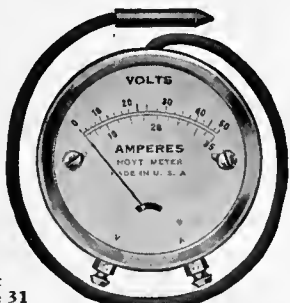

**Hoyt  
Type 31  
Pocket Meter**

The indispensable pocket instrument for Dealers and Radio-Owners for checking the condition of A and B batteries. Reads up to 50 volts or 35 amperes. All scales are hand-calibrated, resistance of meter is unusually high for this type, accuracy does not vary in extreme heat or cold.

Finished in polished nickel, of small size, convenient for handling.

Price, complete with lead \$3.00 ★

**BURTON-ROGERS CO.**  
26 Brighton Ave. Boston, Mass.  
National Distributors

*HOYT makes a complete line of Radio Meters.  
Send for booklet "HOYT Meters for Radio"*

# DIAMOND-WEAVE

(TRADE-MARK REGISTERED Aug. 4, 1925)

# SICKLES COILS



*For the "Aristocrat,"  
Browning-Drake, Roberts,  
Craig, and Hoyt Circuits*  
(Patented Aug. 21, 1923)

Sickles Coil Set No. 18A for Roberts Circuit, containing our new center-tapped N-P Coil. Price \$8.00.

*Sickles Coils for the "Aristocrat" Circuit, designed upon new scientific discoveries, set highest standards of efficiency.*

### COIL PRICES

No. 18A Roberts Circuit	\$ 8.00 set
No. 24 Browning-Drake	7.50 set
No. 20 Craig Circuit	4.50 set
No. 19 Acme Reflex	4.50 set
No. 8 Knockout Reflex	4.00 set
No. 21 Hoyt Circuit	10.00 set
No. 25 "Aristocrat" Circuit	8.00 set

Our Coil Set No. 25 is specifically designed for the new "Aristocrat" Circuit, already very popular.

Compactness of form, rigidity of construction, and the supremely efficient Diamond-Weave method of winding are well-known characteristics of Sickles Coils.

These refinements of design and construction result in low distributed capacity, low dielectric losses and large range of frequency with small variable capacity.

There are Sickles Diamond Weave Coils for all leading circuits.

*Send for descriptive catalog*

## The F. W. Sickles Co.

132 Union Street  
SPRINGFIELD, MASS. ★

**FREE!**

To Each Purchaser of a **WORLD 6V. Auto or Radio BATTERY**

**12-Cell — 24-Volt Storage 'B' Battery**

Positively given free with each purchase of a WORLD "A" Storage Battery. You must send this ad with your order. WORLD Batteries are famous for their guaranteed quality and service. Backed by years of successful manufacture and thousands of satisfied users. Equipped with **Solid Rubber Case**, an insurance against acid and leakage. You save 50 per cent and get a **2-Year Guarantee** ★

**Bond in Writing** WORLD Battery owners "tell their friends." That's our best proof of performance. Send your order in today.

**Solid Rubber Case Radio Batteries**  
 6-Volt, 100-Amperes . . . \$11.25  
 6-Volt, 120-Amperes . . . 13.25  
 6-Volt, 140-Amperes . . . 14.00

**Solid Rubber Case Auto Batteries**  
 6-Volt, 11-Plate . . . \$11.25  
 6-Volt, 13-Plate . . . 13.25  
 12-Volt, 7-Plate . . . 16.00

**Send No Money** Just state battery wanted and we will ship day order is received, by Express, C. O. D. subject to your examination on arrival. **FREE "B" Battery** included. **Extra Offer:** 5 per cent discount for cash in full with order. Buy now and get a guaranteed battery at 50 per cent saving to you.

**WORLD BATTERY COMPANY**  
 1219 So. Wabash Ave., Dept. 24 CHICAGO, ILL.

**World STORAGE BATTERIES**  
 KDKA — WFAF — WGN — WJS — KHJ — KGO — KFAF — WJY — KOP

**Big FREE RADIO Catalog & Guide**

**PARTS, HOOK-UPS, SETS and KITS**

Send now for this valuable **FREE** book. Full of advanced hook-ups, parts and kits. A real guide. Shows factory built sets and the new ideas in radio. Send at once. No charge. No obligation. Please include name of radio fan.

**BARAWIK CO.**  
 102-109 S. Canal St., Chicago

**"It gets that last mile"**

**The AIRGAP SOCKET**

Will rid your set of those squawks, howls and frying noises. They prevent closed circuit absorption of current, inter-coupling of circuits, feedback and undesirable capacity. **THEY MAKE ANY CIRCUIT** more stable and sharpen tuning, resulting in purer and clearer tones with more volume particularly on distant stations.

At all dealers 75c each  
 Sent direct if your dealer cannot supply you.

**AIRGAP PRODUCTS CO. MFR.**  
 188 N. J. R. Rd. Ave., Newark, N. J.

**SEE THAT GAP** ★

success, and next year—or whenever you decide to have another week of international tests—let's hope that there will not be so many bloopers. If they all make sets described in RADIO BROADCAST, there certainly will not be.

Very truly yours,  
 G. JOHNSON.  
 Bloomington, Illinois.

*A Setback to the Florida Boom*

IN MANY districts code interference has been materially reduced through a general coöperative campaign of the newspapers and magazines which circulate in those areas, in which pressure was brought to bear on the offenders. There are still too many districts, however, where broadly tuned transmitters are a source of constant annoyance to listeners of both local and distant broadcasting stations. The Florida peninsula, it would appear, from this letter suffers badly from coast to coast interference.

Editor, RADIO BROADCAST,  
 Doubleday, Page & Company,  
 Garden City, New York.

Sir:  
 Ship to shore transmission is responsible in this locality for the worst form of interference encountered. "Sparks" will sit on the key at just about the time the broadcast program is at its best, and often it seems as if he had held up his work to fill the air between then and twelve o'clock. The wonderful New Year's treat from wjz was perfect as regards volume and modulation, but all through the stellar offering of McCormack and Bori there was only one brief song not ruined by code.

Very truly yours,  
 FREDERIC B. HYDE,  
 Miami, Florida.

*A Letter from the Philippines*

TAKING Horace Greeley's "Go West" thoroughly to heart, apparently irrespective of any human element, one copy of RADIO BROADCAST has monthly wended its weary way right out to the Philippines, there, we presume from that so enthusiastic letter following, to be eagerly read by at least one "satisfied customer." The letter:

Editor, RADIO BROADCAST,  
 Doubleday, Page & Company,  
 Garden City, New York.

Sir:  
 I have already received the new size November and December numbers of the RADIO BROADCAST. I want to congratulate you on the progress and success your magazine is making. It is the best magazine of its kind that I have ever yet seen and so cheap that anybody can afford to subscribe. Its articles are very interesting and highly instructive. Its hook-ups are all "knockouts."

Before I subscribed to this magazine I hadn't an inkling of radio; now I am proud to say that I am the first home-constructor in this province. The department "For the Radio Beginner" should be continued as it is always very instructive to the novices and fans.

Wishing you a prosperous year for RADIO BROADCAST.

Very truly yours,  
 JUAN CARBALLO.  
 La Carlota, Philippines.

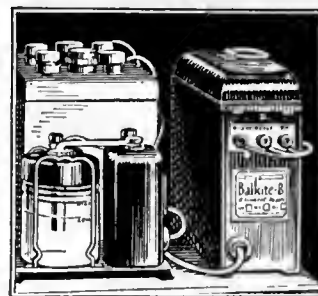

★  
**Convert your present radio receiver into a light socket set with a Balkite Trickle Charger and Balkite "B"**

FANSTEEL PRODUCTS CO., Inc.  
 North Chicago, Illinois

**Thorola Receivers and Speakers** ★  
**Must Outperform**

Reichmann Company, 1725-39 W. 74th St., Chicago

*A Laboratory Product* ★

**CRESCENT LAVITE RESISTANCES**  
*for Distortionless Amplification*

Insure distortionless amplifications and a clarity of tone not obtained through any other resistance. All capacities 12,000 ohms and up. List price \$1.50. Special sizes to order. Write for full information.

Crescent Radio Supply Co. 1-3 Liberty St., Jamaica, N. Y.

**\$6.50 APOLLO Parlor Model**

Stands 22 inches high, has a ten inch bell, gives faithful reproduction and may be varied from a whisper to a torrent of sound by the adjustable unit control without the least loss of the sweet mellow, clear tones that are found in the Apollo Speakers. Mail orders promptly filled. Send no money, just pay the postman.

**HARD RUBBER PANELS**

Size	Black
7 x 10 . . . . .	.32
7 x 12 . . . . .	.39
7 x 14 . . . . .	.42
7 x 18 . . . . .	.56
7 x 21 . . . . .	.64
7 x 24 . . . . .	.75
7 x 26 . . . . .	.85
7 x 30 . . . . .	.96

**Rix Radio Supply House, Inc.**  
 5505 Fourth Ave. Dept. 45 Brooklyn, N. Y.

THE *Dependable* B-POWER

# Constant-B

Replaces Your "B" Batteries Permanently

AFTER installing the All-American "Constant-B" you need only snap the electric switch to have permanent and constant plate power for your radio, direct from the light socket. With it there is no ruinous acid, no hum—nothing but the pure, full tone that is only possible when the "B" voltage is constantly up to standard. Write for descriptive folder showing how to use "Constant-B" with any set.

Price \$45 COMPLETE WITH RAYTHEON TUBE

**ALL-AMERICAN RADIO CORPORATION**

*Pioneers in the Radio Industry*

4213 BELMONT AVENUE, CHICAGO, U. S. A.

Complete instructions for building a similar "Permanent Plate Supply Unit" may be had free upon request. Specify Bulletin B-82.



Published by  
Kansas City,

# FRESHMAN

Announces  
Another SENSATION!

Model 6-F-1

New and Improved  
**FRESHMAN**  
**MASTERPIECE**

**The World's Greatest  
Radio Receiving Set**

Freshman's latest sensation has a real appeal to the women of the home. It is built of five-ply genuine mahogany; a handsome piece of furniture that fits in any corner of the room. It is compact and comparatively small, giving it preference over clumsy consoles. Contains an especially large tone chamber.

**With Built-in Loud Speaker of  
Great Volume and Superb Tone**

When not used as a radio it can be entirely closed. The top is stationary and provides an attractive resting place for vases and other ornaments. Spacious compartments afford ample room for all batteries, etc.—not a single wire being visible.

**THE RADIO RECEIVER WOMEN  
HAVE BEEN WAITING FOR—**

*Prices slightly higher Denver and West and Canada*



\$ **99** **50**

Sold on Convenient Terms by Authorized Freshman  
Dealers Who Also Install and Service Them

**CHAS. FRESHMAN CO., Inc.** Freshman Building, New York  
2626 W. Washington Blvd., Chicago

★ Tested and approved by RADIO BROADCAST ★











